

Service

This manual is to be used by qualified appliance technicians only. Maytag does not assume any responsibility for property damage or personal injury for improper service procedures done by an unqualified person.

Dryer

ADE7005AK*	MDE3706AY*	MDG3758AW*
ADE7005AY*	MDE3706AZ*	MDG4657AW*
ADE9005AG*	MDE3757AY*	MDG4658AW*
ADG7005AW*	MDE3758AY*	MDG4806AW*
CDE6505*	MDE3758AZ*	MDG508DAW*
CDE6505AZ*	MDE4657AY*	MDG5806AW*
CDE9505*	MDE4658AY*	MDGT236AW*
CDE9505AZ*	MDE4806AY*	MDGT336AW*
CDG6505*	MDE4806AZ*	MDGT446AW*
CDG9505*	MDE508DAY*	NDE2335AY*
CYE3005AG*	MDE5806AY*	NDE2335AZ*
CYE3005AK*	MDE5806AZ*	NDE5805AY*
CYE3005AY*	MDET236AY*	NDE5805AZ*
CYE3005AZ*	MDET236AZ*	NDE8805AY*
CYG1005AW*	MDET336AY*	NDE8805AZ*
CYG3005AW*	MDET336AZ*	NDG2335AW*
HYE2205AG*	MDET446AY*	NDG5805AW*
HYE2205AK*	MDET446AZ*	NDG8805AW*
MDE208DAY*	MDG208DAW*	PDET910AY*
MDE2706AY*	MDG2706A*	PDET910AZ*
MDE2706AZ*	MDG270SAW*	PDET920AY*
MDE308DAY*	MDG308DAW*	PDET920AZ*
MDE3706AG*	MDG3706AW*	PDGT910AW*
MDE3706AK*	MDG3757AW*	PDGT920AW*

Admiral 

Amana 

 **Magic Chef** 

 **MAYTAG** 

This Base Manual covers general information

Refer to individual Technical Sheet
for information on specific models

This manual includes, but is
not limited to the following:

MAYTAG 

©2006 Maytag Services

16026315
January 2006

Important Information

Important Notices for Servicers and Consumers

Maytag will not be responsible for personal injury or property damage from improper service procedures. Pride and workmanship go into every product to provide our customers with quality products. It is possible, however, that during its lifetime a product may require service. Products should be serviced only by a qualified service technician who is familiar with the safety procedures required in the repair and who is equipped with the proper tools, parts, testing instruments and the appropriate service information. **IT IS THE TECHNICIANS RESPONSIBILITY TO REVIEW ALL APPROPRIATE SERVICE INFORMATION BEFORE BEGINNING REPAIRS.**



WARNING

To avoid risk of severe personal injury or death, disconnect power before working/servicing on appliance to avoid electrical shock.

To locate an authorized servicer, please consult your telephone book or the dealer from whom you purchased this product. For further assistance, please contact:

Customer Service Support Center

Telephone Number

CAIR Center 1-800-688-9900

CAIR Center in Canada 1-800-688-2002

Web Site

WWW.MAYTAG.COM

Recognize Safety Symbols, Words, and Labels



DANGER

DANGER—Immediate hazards which **WILL** result in severe personal injury or death.



WARNING

WARNING—Hazards or unsafe practices which **COULD** result in severe personal injury or death.



CAUTION

CAUTION—Hazards or unsafe practices which **COULD** result in minor personal injury, product or property damage.

Important Information	2
Important Safety Information	4
General Information	
Model Identification	8
Serial Label Location	8
Model Nomenclature	9
Troubleshooting	
Troubleshooting General Symptoms	10
Component Testing Information	
Component Testing Information	14
Disassembly Procedures	
Control Console Access/Facia Removal	16
PC Board Removal	16
Cycle Selector Knob Removal	17
Switch Removal	17
Top Cover/Door Switch/Front Panel/Gasket Removal	17
Door Reversal/Disassembly Removal	18
Light Removal	19
Motor/Blower/Thermistor/Thermostat Removal	20
Drum Removal/Roller/Glide Access	22
Heater Removal	23
Drim Baffle Removal	23
Gas Model Disassembly Procedures	
Igniter Removal	24
Burner Removal	24
Appendix A	
Installation Instructions	A-1
Appendix B	
Use And Care	B-1

Important Information

Important Notices for Servicers and Consumers

Maytag will not be responsible for personal injury or property damage from improper service procedures. Pride and workmanship go into every product to provide our customers with quality products. It is possible, however, that during its lifetime a product may require service. Products should be serviced only by a qualified service technician who is familiar with the safety procedures required in the repair and who is equipped with the proper tools, parts, testing instruments and the appropriate service information. **IT IS THE TECHNICIANS RESPONSIBILITY TO REVIEW ALL APPROPRIATE SERVICE INFORMATION BEFORE BEGINNING REPAIRS.**



WARNING

To avoid risk of severe personal injury or death, disconnect power before working/servicing on appliance to avoid electrical shock.

To locate an authorized servicer, please consult your telephone book or the dealer from whom you purchased this product. For further assistance, please contact:

Customer Service Support Center

Telephone Number

CAIR Center 1-800-688-9900

CAIR Center in Canada 1-800-688-2002

Web Site

WWW.MAYTAG.COM

Recognize Safety Symbols, Words, and Labels



DANGER

DANGER—Immediate hazards which **WILL** result in severe personal injury or death.



WARNING

WARNING—Hazards or unsafe practices which **COULD** result in severe personal injury or death.



CAUTION

CAUTION—Hazards or unsafe practices which **COULD** result in minor personal injury, product or property damage.

Important Information	2
Important Safety Information	4
General Information	
Model Identification	8
Serial Label Location	8
Model Nomenclature	9
Troubleshooting	
Troubleshooting General Symptoms	10
Component Testing Information	
Component Testing Information	14
Disassembly Procedures	
Control Console Access/Facia Removal	16
PC Board Removal	16
Cycle Selector Knob Removal	17
Switch Removal	17
Top Cover/Door Switch/Front Panel/Gasket Removal	17
Door Reversal/Disassembly Removal	18
Light Removal	19
Motor/Blower/Thermistor/Thermostat Removal	20
Drum Removal/Roller/Glide Access	22
Heater Removal	23
Drim Baffle Removal	23
Gas Model Disassembly Procedures	
Igniter Removal	24
Burner Removal	24
Appendix A	
Installation Instructions	A-1
Appendix B	
Use And Care	B-1

Important Safety Information

WARNING

To avoid risk of fire, electric shock, serious injury, or death when using your dryer, follow these basic precautions:

1. Read all instructions before using dryer.
2. Install dryer according to Installation Instructions. Refer to the Grounding Instructions in the Installation Instructions for proper grounding of the dryer.
3. Do not dry articles that have been cleaned in, washed in, soaked in, or spotted with gasoline, dry-cleaning solvents, or other flammable or explosive substances. Vapors could ignite or explode.
4. Do not use dryer to dry clothes which have traces of any flammable substance, such as vegetable oil, cooking oil, machine oil, flammable chemicals, thinner, etc., or anything containing wax or chemicals, such as mops and cleaning cloths. Flammable substances may cause fabric to catch fire by itself.
5. Do not store or use gasoline or other flammable vapors and liquids near this or any other appliance.
6. Do not allow children to play on or in dryer. Close supervision of children is necessary when dryer is used near children, a safety rule for all appliances.
7. Before dryer is removed from service or discarded, remove doors to drying compartment.
8. Do not reach into dryer if cylinder is revolving.
9. Do not install or store dryer where it will be exposed to water and/or weather.
10. Do not tamper with dryer controls.
11. Do not repair or replace any part of dryer or attempt any service, unless specifically recommended in user-maintenance instructions or in published user-repair instructions that you understand and have skills to carry out, if you are a consumer.
12. To reduce risk of electric shock or fire, do not use extension cords or adapters to connect dryer to electrical power source.
13. Use the dryer only for its intended purpose, drying clothes.
14. Always disconnect dryer from electrical supply before attempting any service. Disconnect power cord by grasping the plug, not the cord.
15. Do not use heat to dry articles containing foam rubber or similarly textured rubberlike materials.
16. Always clean the lint filter after every load. A layer of lint in the filter reduces drying efficiency and prolongs drying time.
17. Use only fabric softeners or products to eliminate static that are appropriate for automatic dryers.
18. Keep your dryer in good condition. Bumping or dropping dryer can damage safety features. If damage occurs, have dryer checked by qualified service technician.
19. Replace worn power cords and/or loose plugs.
20. Do not tumble fiberglass curtains and draperies unless the label says it can be done. If they are dried, wipe out the cylinder with a damp cloth to remove particles of fiberglass.
21. Always read and follow manufacturer's instructions on packages of laundry aids. Heed all warnings or precautions. To reduce risk of poisoning or chemical burns, keep products away from children at all times, preferably, in a locked cabinet.
22. Never operate dryer with guards and/or panels removed.
23. Do not operate dryer with missing or broken parts.
24. Do not bypass safety devices.
25. Keep area around the exhaust opening and adjacent surrounding areas free from accumulation of lint, dust, and dirt.
26. Interior of dryer and exhaust duct should be cleaned periodically by qualified service personnel.
27. Dryer will not operate with loading door open. DO NOT bypass door safety switch by permitting dryer to operate with door open. Dryer will stop tumbling when door is opened. Do not use dryer if it does not stop tumbling when door is opened or starts tumbling without pressing or turning the START mechanism. Remove the dryer from use and call the service person.
28. Remove laundry immediately after the dryer stops.
29. ALWAYS follow the fabric care instructions supplied by the garment manufacturer.

Save These Instructions

Important Safety Information

Electrical Service Information

Electrical Dryers

- 240 VAC, 60 Hz, 30 Amps, 3-wire or 4-wire installations

Gas Dryers

- 120 VAC, 60 Hz, 15 Amps, 3-wire installations

About Ground Wires

In the event of an electrical short circuit, a ground wire reduces the risk of electric shock by providing an escape wire for the electric current.

Standard accepted color coding for ground wires is **green** or **green with a yellow stripe**.

Grounding wires and wires colored like grounding wires are **NOT** to be used as current carrying conductors.



WARNING

To reduce the risk of fire, electric shock, serious injury or death, all wiring and grounding must conform with the latest edition of the National Electric Code, or the Canadian Electrical Code, and such local regulations as might apply. It is the customer's responsibility to have the wiring and fuses checked by a qualified electrician to make sure your home has adequate electrical power to operate the dryer.



WARNING

To avoid risk of personal injury or death due to electrical shock:

- **Observe all local codes and ordinances.**
- Disconnect electrical power to unit before servicing.
- Ground appliance properly.
- Check with a qualified electrician if you are not sure this appliance is properly grounded.
- DO NOT ground to gas line.
- DO NOT ground to cold water pipe if pipe is interrupted by plastic, nonmetallic gaskets, or other insulating (nonconducting) materials.
- DO NOT modify plug on power cord. If plug does not fit electrical outlet, have proper outlet installed by qualified electrician.
- DO NOT have a fuse in the neutral or ground circuit. A fuse in the neutral or ground circuit could result in an electrical shock.
- DO NOT use an extension cord with this appliance.
- DO NOT use an adapter plug with this appliance.
- DO NOT pinch power cord.



WARNING

To reduce the risk of fire and exposure to combustion gases, the dryer **MUST** be exhausted to the outdoors. **DO NOT** exhaust dryer air into a window well, gas vent, chimney or enclosed, unventilated area, such as an attic, wall, ceiling, crawl space under a building or concealed space of a building.

Gas Dryer Power Supply

This equipment **MUST** be grounded. In the event of an electrical short circuit, grounding reduces the risk of electric shock by providing an escape wire for the electrical current. This unit is equipped with a cord having a grounding wire with a grounding plug. The plug must be plugged into an outlet that is properly installed and grounded.

Consult a qualified electrician or servicer if grounding instructions are not completely understood, or if doubt exists as to whether the equipment is properly grounded.

Do not use an extension cord. If the product power cord is too short, have a qualified electrician install a three-slot receptacle. This unit should be plugged into a separate 60 hertz circuit with the electrical rating as shown on the serial plate.

Proper Grounding and Polarization for 120 Volts Wall Outlets

For the safety of our customers and the service technician ALL gas dryers have a three-prong power cord and **MUST** be connected to a properly polarized and grounded wall outlet. This information was written for those who do not understand grounding and polarization of a wall outlet. A 120 VAC wall outlet must always be wired as shown below.

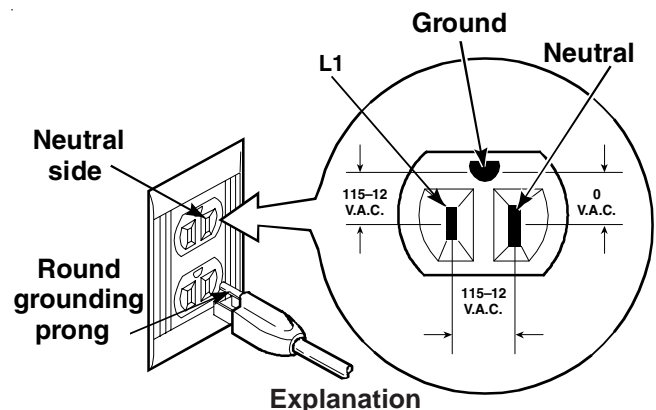

Polarization—This means that the larger slot must be neutral and the small slot must be hot (live).

Mispolarized—The outlet is miswired so that the larger slot is hot (live) and the smaller slot is neutral.

Grounded—This means the round hole connection is connected to ground through a connection to the main power panel.

Ungrounded—The round hole connection is not connected to a ground and/or the main power panel.

Important Safety Information

Gas Connection Information

WARNING

To avoid death, personal injury or property damage, from fire or explosion, information in this manual must be followed exactly.

Do not store or use gasoline or other flammable vapors and liquids in the vicinity of this or any other appliance.

WHAT TO DO IF YOU SMELL GAS

- Do not try to light any appliance.
- Do not touch any electrical switch; do not use any phone in your building.
- Immediately call your gas supplier from a neighbor's phone. Follow the gas supplier's instructions.
- If you cannot reach your gas supplier, call the fire department.

Installation and service must be performed by a qualified installer, service agency or the gas supplier.

WARNING

To reduce the risk of fire and exposure to combustion gases, the dryer **MUST** be exhausted to the outdoors. **DO NOT** exhaust dryer air into a window well, gas vent, chimney or enclosed, unventilated area, such as an attic, wall, ceiling, crawl space under a building or concealed space of a building.



WARNING

FOR GAS AND ELECTRIC MODELS



A clothes dryer produces combustible lint. To reduce the risk of fire, dryer MUST BE EXHAUSTED OUTDOORS.

LP 500497R5

FOR GAS MODELS



To reduce the risk of accumulating unsafe concentrations of combustion gasses, the dryer MUST BE EXHAUSTED OUTDOORS.

WARNING

To reduce the risk of electrical shock, disconnect the electrical power before servicing.

WARNING

Appliance grounded to neutral conductor through a link. If used in a mobile home or if local codes do not permit grounding through the neutral, (1) Disconnect the link from the neutral, (2) Use grounding terminal or lead to ground appliance in accordance with local codes and (3) Connect neutral terminal or lead to branch circuit neutral in usual manner (if connected by means of cord kit, use a 10 AWG four-conductor cord).

WARNING

To reduce the risk of fire this appliance **MUST BE EXHAUSTED OUTDOORS.**

ALCOVE/CLOSET - OUTDOOR EXHAUST:

1. **DO NOT** INSTALL STACK DRYER IN A CLOSET.
2. Dryer **MUST** BE vented outdoors.
3. Minimum clearance to combustible material (inch / cm).

LOCATION	HOME DRYER	REG. COIN	STACK DRYER
Sides	0/0	0/0	0/0
Rear	0/0	0/0	4/10.2
Top of Control Hood	12/30.5	12/30.5	---
Exhaust Duct	5/1.3	2/5.1	2/5.1
Top (Front-First 4")	---	---	0/0
Top (Remaining)	---	---	2/5.1
Front	2/5.1	2/5.1	---

IMPORTANT INSTALLATION INSTRUCTIONS

POWER SUPPLY CONNECTIONS:

- Connect this appliance to a separate branch circuit with a No. 10 AWG wire (copper conductors only) rated and protected with a 30 Amp circuit breaker or time delay fuse.
- Connect to power supply with "Maximum Rated Voltage" listed on name plate.

CLEARANCE AND VENTING INSTRUCTIONS:

a. FREE STANDING - OUTDOOR EXHAUST:

1. Dryer **MUST** BE vented to outdoors.
2. Minimum clearance to combustible material: (inch / cm).

LOCATION	HOME DRYER	REG. COIN/STACK
Sides & Rear	0/0	0/0
Top of Control Hood	12/30.5	12/30.5
Exhaust Duct	5/1.3	2/5.1

• See Installation Instructions for Details

NOTICE

If thermal fuse is OPEN, check for inoperative limit thermostat, heater and other causes of inoperation, such as restricted airflow. Replace inoperative parts.

61294R5

6

16026315

©2006 Maytag Services

Important Safety Information

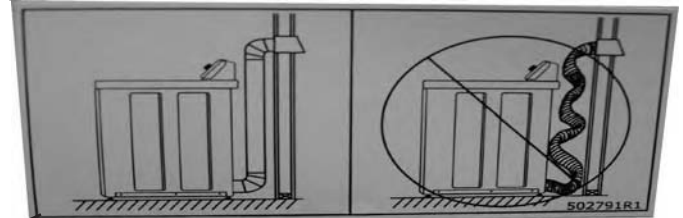

NOTICE

- Connect this appliance to a separate branch circuit rated and fused at 15 amps.
- Connect to power supply with "MAXIMUM RATED VOLTAGE" listed on serial plate.

500495R1



! WARNING

- To reduce the risk of fire:

1. **ONLY** use for drying water washed fabrics.
2. **DO NOT** dry articles containing foam rubber, plastics or similarly textured rubber like materials.
3. **DO NOT** put articles soiled with flammable liquids or cleaning solvents in the dryer.
4. **DO NOT** put articles soiled with vegetable or cooking oil in the dryer, as these oils may not be removed during washing. Due to the remaining oil, the fabric may catch on fire by itself.
5. **ALWAYS** clean lint filter before each load.

! CAUTION

- For your safety:

1. A clothes dryer produces combustible lint and **MUST BE EXHAUSTED OUTDOORS**. Care must be taken to prevent the accumulation of lint around the exhaust opening and in the surrounding area.
2. **DO NOT** let children play in or on dryer.

500281R5



! WARNING !

To operate safely, all panels must be in place.

To reduce the risk of electric shock, disconnect electric power before servicing.

To reduce the risk of injury during servicing, keep clear of rotating parts when machine is operating.

NOTE: Special drive belt required. Use factory replacement parts only.

NOTE: U

NOTICE

When reassembling front air duct be sure seal between air duct and blower housing is correctly positioned.

56259R8

General Information

Model Identification

Complete registration card and promptly return. If registration card is missing:

- For Maytag product call 1-800-688-9900 or visit the Web Site at www.maytag.com
- For product in Canada call 1-800-688-2002 or visit the Web Sites at www.maytag.com or www.jennair.com

When contacting provide product information located on rating plate. Record the following:

Model Number: _____
Manufacturing Number: _____
Serial or S/N Number: _____
Date of purchase: _____
Dealer's name and address: _____



Serial Label is located in the upper left of the door opening and back panel.

Service

Keep a copy of sales receipt for future reference or in case warranty service is required. To locate an authorized servicer:

- For Maytag product call 1-800-462-9824 or visit the Web Site at www.maytag.com
- For product in Canada call 1-866-587-2002 or visit the Web Site at www.maytag.com

Warranty service must be performed by an authorized servicer. We also recommend contacting an authorized servicer, if service is required after warranty expires.

Parts and Accessories

Purchase replacement parts and accessories over the phone. To order accessories for your product call:

- For Maytag product call 1-800-462-9824 or visit the Web Site at www.maytag.com
- For product in Canada call 1-866-587-2002 or visit the Web Sites at www.maytag.com

Extended Service Plan

We offer long-term service protection for this new dryer.

- Dependability PlusSM Extended Service Plan is specially designed to supplement Maytag's strong warranty. This plan covers parts, labor, and travel charges.
Call 1-800-925-2020 for information.

General Information

Dryer Nomenclature

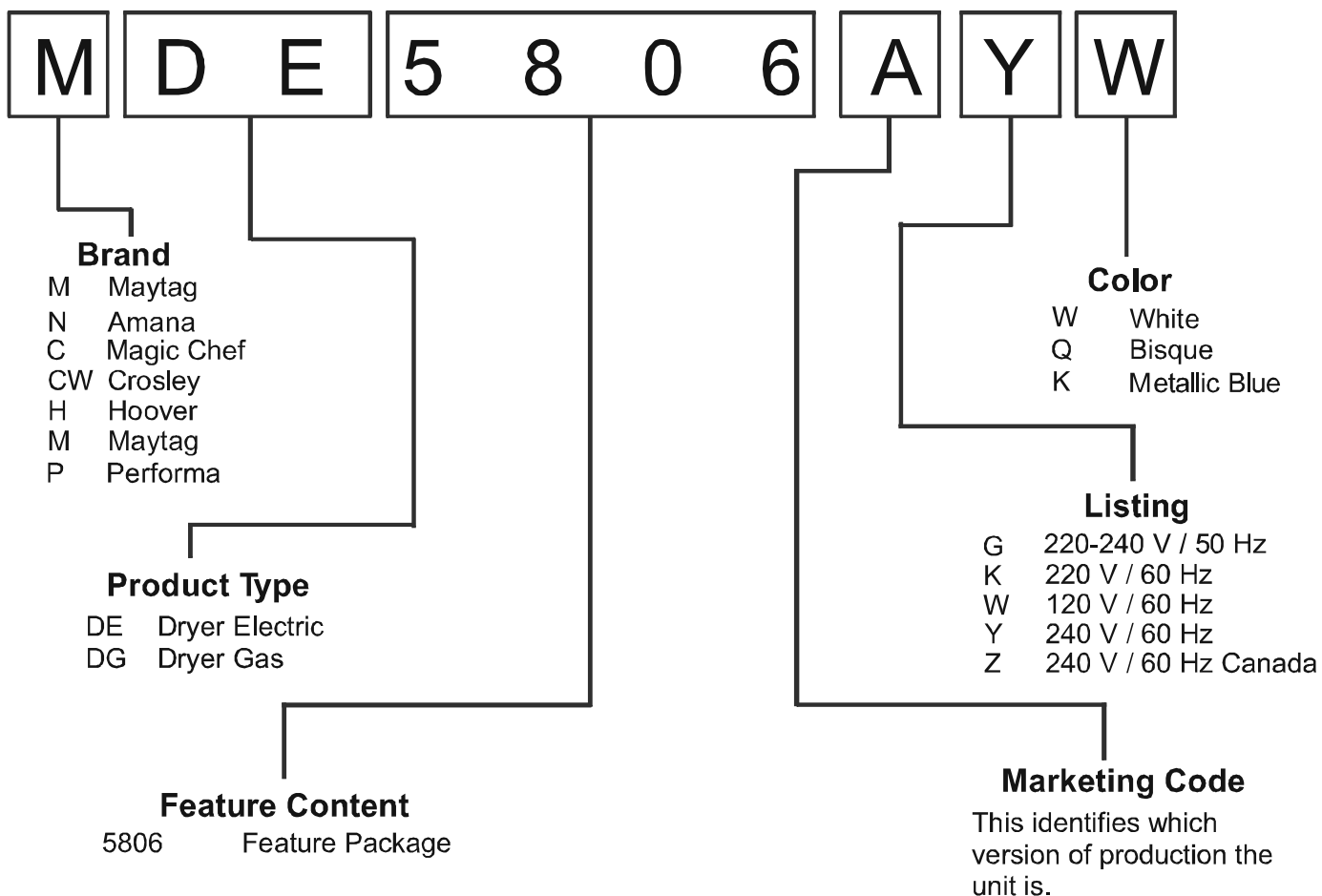

Troubleshooting Guide is located inside the Control Console, see Control Console Access/Facia Removal Procedure.

Troubleshooting Procedures

Due to possibility of personal injury or property damage, always contact an authorized technician for servicing or repair of this unit.



WARNING

To avoid risk of electrical shock, personal injury or death; disconnect power and shut off gas to unit before servicing, unless testing requires power.

Will not start or run:

- All wires are hooked up to their corresponding terminals.
- Dryer is plugged in.
- Blown fuse or circuit breaker.
- Door switch functional...door closed. Check for error code 3 (See Table for code definition).
- Start/Pause rotary selector dial functional.
- Control Board operational.
- Drive motor functional.
- Check motor winding resistance.

Motor runs/ tumbler will not turn:

- Belt off or broken/damaged.
- Idler tension spring too weak or stretched.
- Idler pulley jammed or stuck.

Runs a few minutes and then stops:

- Empty dryer.
- Check motor spins freely.
- Lint buildup around drive motor.
- Low voltage present.
- Blower impeller blocked in blower housing.
- Drive motor - start switch contacts stuck closed.

Improper drying/clothes wrinkled/ rough texture/long dry time:

- Lint filter is not clean.
- Restriction in exhaust.
- Outside exhaust hood damper door stuck closed.
- Exhaust too long, too many elbows, flex ductwork installed.
- Poor intake air available for the dryer.
- Incorrect tumbler speed. Tumbler belt slipping.
- Blower impeller bound; check for foreign material in blower area.
- Customer overloading dryer.
- Check clothing labels for fabric content and cycle selected.
- Clothes too wet due to insufficient spin out by washer.

Troubleshooting the electronic control circuit:

- Check for miswiring of the electrical connector at the electronic control board.

Will Not Shut Off

- Check dryer heat setting (wet clothes on air fluff will run an **extended** period of time).
- Check Membrane Pad.
- Check Electronic Control Board.
- Short in sensor circuit.
- Ensure timer motor is getting 120V with no load or in cool down.
- Check thermostat.

Noisy and/Or Vibration

- **Thumping** Check for loose tumbler baffle, rear tumbler roller(s) worn or misaligned, out-of-round tumbler or high weld seam on tumbler.
- **Ticking** Check for loose wire harness or object caught in blower wheel area.
- **Scraping** Check for front or rear bulkhead felt seal out of position or worn tumbler front bearings.
- **Roaring** Check for blower wheel rubbing on blower housing or bad motor bearings.
- **Popping or squealing sound.** Check for a sticky or frayed belt.

Blows fuses or trips circuit breaker —**ELECTRIC Models:**

- The amperage readings are at 240 volts. One line will be 24 amps and the other line will be 21 amps. The neutral line will be at 3 amps. If the above amperages are not present, then the house wiring, fuse box or circuit breaker should be suspect.
- Shorted heating element to housing.
- Incorrect wiring or a wire shorting to ground.
- Drive motor winding shorting to ground.

Blows fuses or trips circuit breaker —**GAS Models:**

- If igniter is not glowing, check for 120 V at igniter.
- Igniter harness may be loose and shorted to base.
- Incorrect wiring or a wire shorted to ground.
- Drive motor winding shorting to ground.

Will Not Dry —**ELECTRIC Models**

Will not heat (motor runs):

- Check dryer heat setting.
- Open heating element.
- Hi-Limit trips easily or is open.
- Regulating thermostat trips easily or is open.
- Check Thermistor.

Will Not Dry —**GAS Models**

Poor Gas Ignition

When the dryer is operated on a heat setting, the igniter should be energized and burner shall fire within 45 seconds at 120 VAC. The failure of a component in this system will usually be indicated by one of three symptoms:

1) The igniter does not glow. If the igniter does not heat up, remove power and using an ohmmeter, check the following:

- Open flame sensor.
- Open igniter.
- Shorted booster coil.
- Open wiring.
- Bad motor switch (Neutral supply).
- No power from control (L1 supply).

2) Igniter glows - No gas ignition. If the igniter heats up but the main burner flame is not ignited, remove power and using an ohmmeter, check the following:

- Open secondary coil.
- Open holding coil.
- Open wire harness.
- Stuck flame sensor (Stuck closed).
- Check:
Holding coil term 1 and 2, 1365 ohms \pm 25 ohms.
Booster coil term 1 and 3, 560 ohms \pm 25 ohms.
Secondary coil term 4 and 5, 1220 ohms \pm 25 ohms.

3) The gas is ignited but the flame goes out. If a normal ignition takes place and after a short while the flame goes out, check for the following:

- Radiant sensor contacts opening prematurely.
- Weak gas valve coil may open when stressed by higher temperatures.
- Weak Hi-Limit.
- Poor venting.
- Bad drum seals.

Troubleshooting Procedures

Due to possibility of personal injury or property damage, always contact an authorized technician for servicing or repair of this unit.



WARNING

To avoid risk of electrical shock, personal injury or death; disconnect power and shut off gas to unit before servicing, unless testing requires power.

ENTER SERVICE MODE

<p>Fabric Selection Sensor Dry Permanent Press Delicates Cycle Status Dry12, Cool Down, Sensor, Complete, Pause Push to Start - Push to Stop</p>	<p>Rotate the Cycle Selector Knob to the "Power Off" position and press knob.</p> <p>(All LED's will be off).</p>
<p>Fabric Selection Sensor Dry Permanent Press Delicates Cycle Status Dry12, Cool Down, Sensor, Complete, Pause Push to Start - Push to Stop</p>	<p>Rotate the Cycle Selector Knob clockwise past "Power Off" twice and stop at "Regular".</p> <p>(LED's will illuminate as the knob is rotated).</p>
<p>Fabric Selection Sensor Dry Permanent Press Delicates Cycle Status Dry12, Cool Down, Sensor, Complete, Pause Push to Start - Push to Stop</p>	<p>Rotate the Cycle Selector Knob counterclockwise one revolution back to "Regular" and press knob.</p> <ul style="list-style-type: none"> • Power Off LED will blink. Regular LED will be illuminated. • Model I.D. is displayed by the LED's around the bottom of the dial. • Model I.D. can be redisplayed while in Service Mode by setting knob to "Delicate" and pressing. • Refer to chart for Model I.D.

EXIT SERVICE MODE

<p>Fabric Selection Sensor Dry Permanent Press Delicates Cycle Status Dry12, Cool Down, Sensor, Complete, Pause Push to Start - Push to Stop</p>	<p>Rotate Cycle Selection Knob to "Power Off" and press knob.</p> <p>or</p> <p>Allow 5 minutes of inactivity.</p> <p>or</p> <p>Disconnect power</p>
--	---

DISPLAY/CLEAR SERVICE CODES

<p>Fabric Selection Sensor Dry Permanent Press Delicates Cycle Status Dry12, Cool Down, Sensor, Complete, Pause Push to Start - Push to Stop</p>	<p>Enter Service Mode then set Cycle Selection Knob to "Time Dry 10". Press knob.</p> <ul style="list-style-type: none"> • Time Dry 10 LED will blink if codes other than power interrupt are present. • Press knob to view codes. Press once for each code. Codes are displayed newest to oldest. Machine beeps three times after last service code is displayed. • To clear codes display a code then press and hold Cycle Selection Knob until machine beeps twice. Time Dry 10 LED stops blinking. • Refer to chart for Service Codes.
--	--

Troubleshooting Procedures

Due to possibility of personal injury or property damage, always contact an authorized technician for servicing or repair of this unit.



WARNING

To avoid risk of electrical shock, personal injury or death; disconnect power and shut off gas to unit before servicing, unless testing requires power.

CONSOLE SWITCH TEST

	<p>Enter Service Mode then set Cycle Selection Knob to "Wrinkle Prevent" and press knob.</p> <ul style="list-style-type: none"> • Power Off LED blinks. • Pause and Wrinkle Prevent LED's are illuminated.
	<p>Rotate the Cycle Selection Knob clockwise for ascending, and counterclockwise for descending test mode. Rotate 32 clicks in the same direction to complete the test.</p>
	<p>Press the Cycle Selection Knob to activate the test for the rotary switches. The test begins with the rotary switch immediately to the left of the Cycle Selection Knob. Rotate the switch in either direction. The LED's illuminate around the bottom of the Cycle Selection Knob for each switch position.</p> <p>NOTE: Any attempt to move a knob or switch other than the one being tested results in a chirp sound.</p>
	<p>Press the Cycle Selection Knob. The test continues with the switch immediately to the left of the previous switch tested. Repeat rotating the switch and monitoring the LED's around the bottom of the Cycle Selection Knob. Continue pressing the Cycle Selection Knob for each switch tested right to left until all rotary switches are tested.</p> <ul style="list-style-type: none"> • After the last rotary switch is tested the next time the Cycle Selection Knob is pressed the test will continue with the rocker switches. Continue pressing the Cycle Selection Knob and testing switches until the last switch is tested. When all switches have been tested the "Complete" LED will illuminate.

SERVICE CYCLE

	<p>Enter Service Mode then set Cycle Selection Knob to "Regular" and press knob.</p> <ul style="list-style-type: none"> • Cool Down LED illuminates. Motor on. • Press knob Cool Down and Wrinkle Prevent LED's illuminate. Motor/Heater on. • Press knob Cool Down LED illuminates. Motor on. • Press knob Complete LED illuminates. Cycle Complete. • Press knob Exit back to Service Mode. <p>NOTE: Press knob until Pause LED begins blinking to pause cycle.</p>
--	---

Troubleshooting Procedures

Due to possibility of personal injury or property damage, always contact an authorized technician for servicing or repair of this unit.



WARNING

To avoid risk of electrical shock, personal injury or death; disconnect power and shut off gas to unit before servicing, unless testing requires power.

DIAGNOSTIC CODE CHART

Service Code Description	Service Code	Drying	Cool Down	Wrinkle Prevent	Complete	Pause
Model ID Unknown, Default used	31	●	●	●	●	●
Rotary Switch 3 left of encoder failed at startup	28	●	●	●	○	○
Rotary Switch 2 left of encoder failed at startup	26	●	●	○	●	○
Rotary Switch 1 left of encoder failed at startup	25	●	●	○	○	●
Incorrect rotary switch position seen	24	●	●	○	○	○
Dryness sensor bar possibly shorted	23	●	○	●	●	●
Dryness sensor bar possibly open	22	●	○	●	●	○
Selected dryer temperature not reached	21	●	○	●	○	●
Dryer over temp without shutdown	20	●	○	●	○	○
Motor thermal protector opened more than 5 times during cycle	18	●	○	○	●	○
Thermistor possible short	17	●	○	○	○	●
Thermistor possible open	16	●	○	○	○	○
Thermistor out of range	15	○	●	●	●	●
Heater on and drum temp not increasing	14	○	●	●	●	○
Power failure		○	○	○	○	●
No code	0	○	○	○	○	○





MODEL CODE CHART

Model Numbers	Drying	Cool Down	Wrinkle Prevent	Complete	Pause
MDE/GT446	○	○	○	○	●
MDE/G4657	○	○	○	●	●
MDE/G4658, MDE/G4806	○	○	●	○	○
MDE/G508D	○	○	●	○	●
MDE/G5806	○	○	●	●	○
NDE/G8805	○	○	●	●	●

Component Testing Information

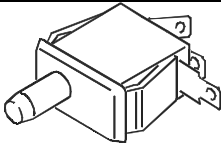
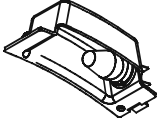
WARNING

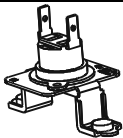
To avoid risk of electrical shock, personal injury or death; disconnect power and shut off gas to unit before servicing, unless testing requires power.

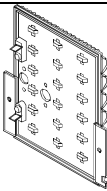
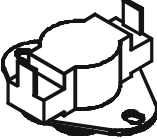
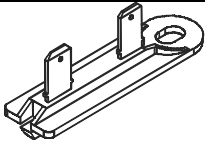



Illustration	Component	Test Procedure	Results
	Thermistor	Unplug harness connector and test from wire insertion side. Pin #1 PK and Pin #11 PK of PS5.....	10000 ohms @ 77° F (25° C)
	Door Switch	Unplug connectors and test switch terminals. Door open terminals..... Door closed terminals.....	Infinity Less than 1 ohm
	Light	Unplug connectors and test switch terminals. Check across terminals.....	80 to 100 ohms
	Motor	Unplug harness connector and test motor circuits. Pin #9 GY and Pin #9 Red (Windings).	2 ohms
	Thermal Fuse	Unplug connectors and test Thermostat terminals. Check across terminals.....	Less than 1 ohm
	Hi Limit Thermostat	Unplug connectors and test Thermostat terminals. Check across terminals.....	Less than 1 ohms
	Thermal Cut Off	Unplug connectors and test Thermostat terminals. Check across terminals.....	Less than 1 ohm
	Heater Element	Unplug connectors and test Heater terminals.....	10 ohms
	Cycling Thermostat 146 °F	Unplug connectors and test Thermostat terminals.....	Less than 1 ohm

Component Testing Information



WARNING

To avoid risk of electrical shock, personal injury or death; disconnect power and shut off gas to unit before servicing, unless testing requires power.

Illustration	Component	Test Procedure	Results
	Sensor Bars	Unplug harness connector and test from wire insertion side. Short sensor bar. Pin #3 BU to Pin # 7 BU of PS5.....	Less than 1 ohm
	Radiant Sensor	Unplug connectors and test sensor terminals.....	Closed
	TH2 Safety Thermostat	Unplug connectors and test Thermostat terminals.....	Less than 1 ohm
	Gas Valve	Unplug connectors and test valve terminals. Check across terminals #1 and #3 (Booster Coil)..... Check across terminals #1 and #2 (Holding Coil)..... Check across terminals #2 and #3 (Both coils in series)..... Check across terminals #4 and #5 (Secondary Coil).....	550 ohms 1350 ohms 1900 ohms 1300 ohms

Motor Contacts

Function	1M	2M	3M	5M	6M
Start			● — ●		
Run	● — ●			● — ●	

● = Contact closed

Centrifugal Switch (Motor)

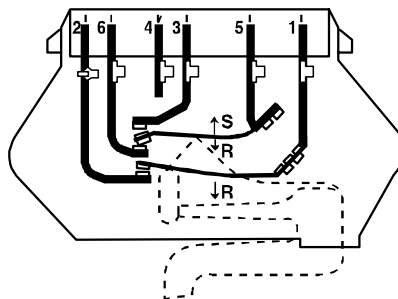

SWITCH SHOWN IN START POSITION

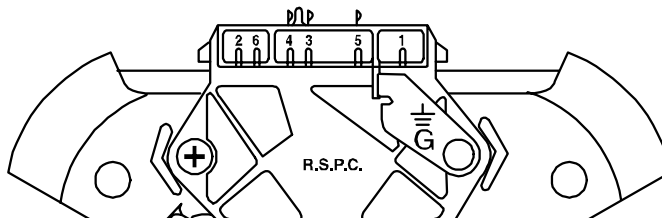

Gas Valve

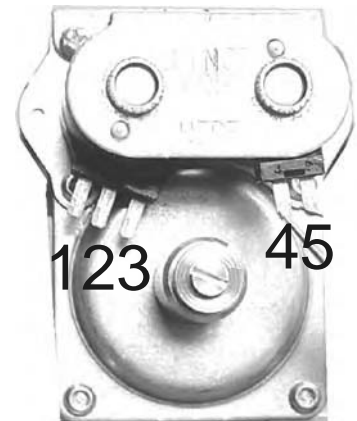

Disassembly Procedures



WARNING

To avoid risk of electrical shock, personal injury or death; disconnect power to unit and shut off gas supply before performing any disassembly procedure.

Control Console Access / Facia Removal

1. Disconnect power supply to unit.
2. Remove Control Knobs and Cycle Selector Knob.



3. Remove three screws from Console top.

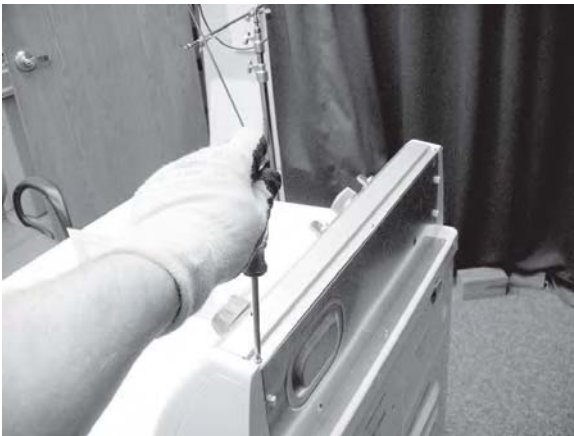

NOTE: Be sure to protect the shafts on the front of the Console when tipping.

4. Tip the Console forward to access the wiring harness and PC Board.

NOTE: Wear an Anti-Static Wrist Strap and ground yourself before working with Electronic Control Boards. Always handle boards by the edge and don't touch discreet components.

5. Depress locking tabs on Facia to remove and replace.

PC Board Removal

1. Disconnect power supply to unit.
2. Access Control Console, see "Control Console Access / Facia Removal" procedure.

NOTE: Wear an Anti-Static Wrist Strap and ground yourself before working with Electronic Control Boards. Always handle boards by the edge and don't touch discreet components.

3. Remove wiring harness connectors from PC Board.

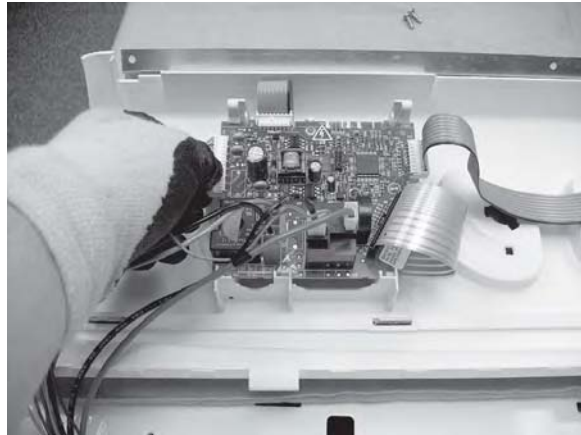

4. Depress the locking tab on the PCB.

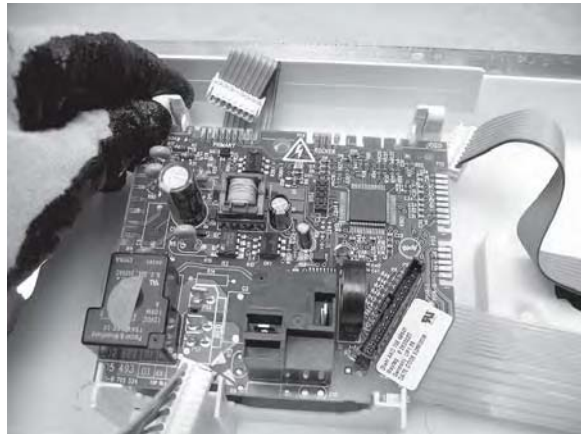

5. Remove the PCB.



Disassembly Procedures

 WARNING
--

To avoid risk of electrical shock, personal injury or death; disconnect power to unit and shut off gas supply before performing any disassembly procedure.

Cycle Selector Knob (CSK) Removal

1. Disconnect power supply to unit.
2. Access Control Console, see "Control Console Access / Facia Removal" procedure.
3. Remove PC Board.
4. Lift locking tab on CSK and rotate switch to remove.

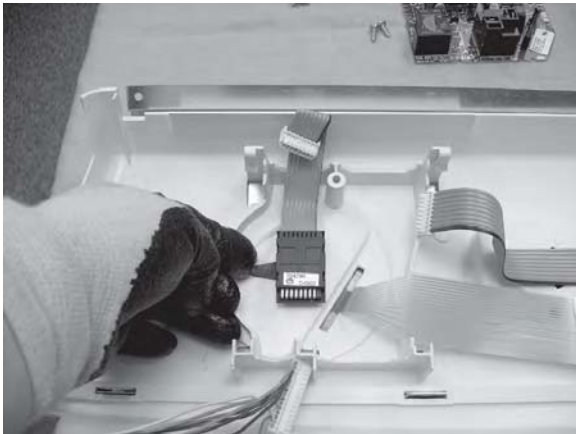

Switch Removal

1. Disconnect power supply to unit.
2. Access Control Console, see "Control Console Access / Facia Removal" procedure.
3. Remove ribbon connectors to switch.
4. Lift locking tab on switch and rotate to remove.

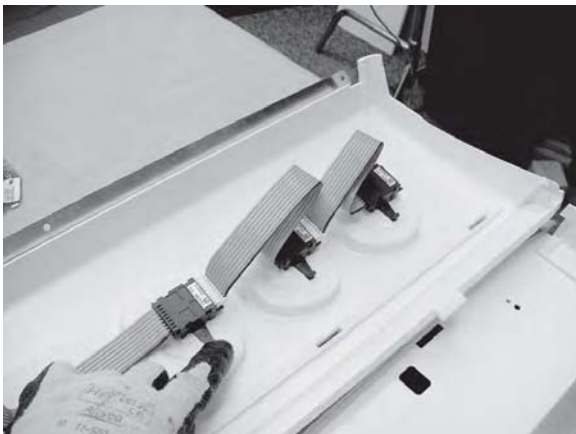

Top Cover / Door Switch / Front Panel / Gasket Removal

1. Disconnect power supply to unit.
2. Use a plastic putty knife to depress the locking clip between the Top Cover and Front Panel.



3. Disconnect wiring from the Door Switch.

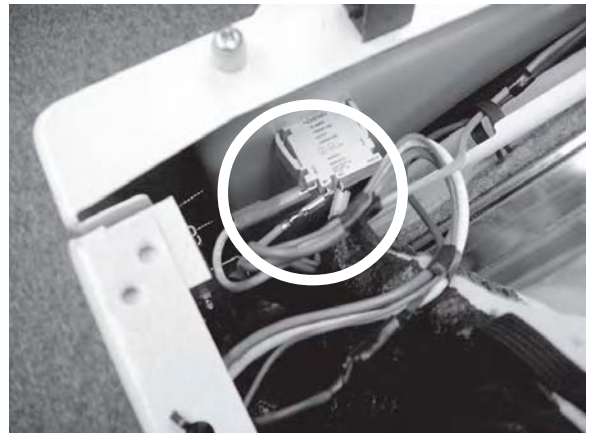

4. Depress the locking tabs on switch side and remove through the front.

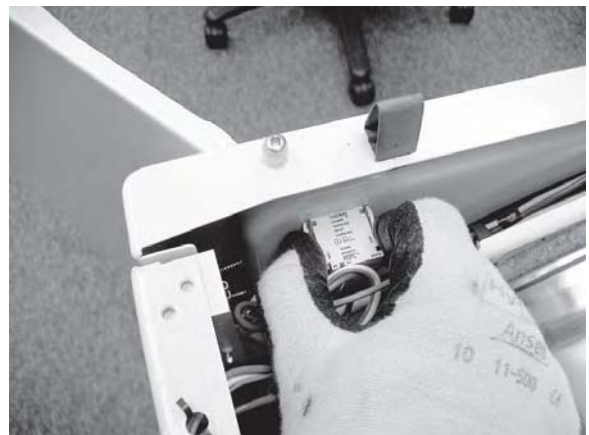

Disassembly Procedures



WARNING

To avoid risk of electrical shock, personal injury or death; disconnect power to unit and shut off gas supply before performing any disassembly procedure.

5. Remove two screws, 1 each side, from the back flange of the Front Panel.

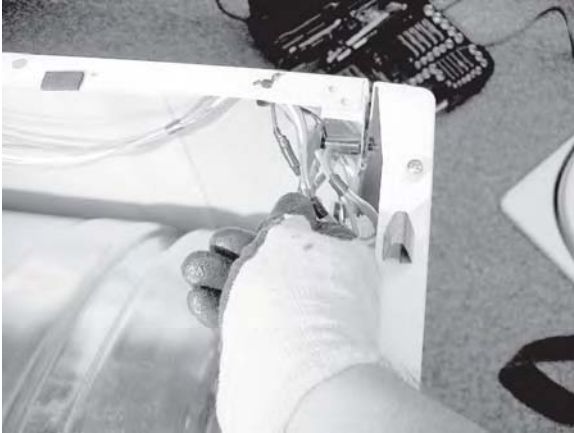

6. Tip Front Panel back and remove. Rotate Front Panel to the back side and remove gasket.



Door Reversal / Disassembly

1. Disconnect power supply to unit.
2. Remove four screws on Door Hinge.



3. Remove hole covers opposite hinge side and install them in the new location.



Disassembly Procedures

 WARNING
--

To avoid risk of electrical shock, personal injury or death; disconnect power to unit and shut off gas supply before performing any disassembly procedure.

4. To switch Door Hinge side, remove screws around the perimeter of the Door Panel. Rotate Door Panel 180 degrees and move Door Strike to opposite side of Door. Reinstall screws. Reinstall Door. Continue to next step for complete Door disassembly.



5. After Door Panel screws are removed the Door Gasket can be removed from the Inner Door Panel.



Light Removal

1. Disconnect power supply to unit.
2. Remove Top Cover, see "Top Cover / Door Switch / Front Panel / Gasket Removal" procedure steps 1 - 2.
3. Remove Lens screw.



4. Depress locking tab on Light Socket and remove through light cavity.



Disassembly Procedures



WARNING

To avoid risk of electrical shock, personal injury or death; disconnect power to unit and shut off gas supply before performing any disassembly procedure.

Motor/Blower/Thermistor/Thermostat Removal

1. Disconnect power supply to unit.
2. Remove Top Cover.
3. Remove Front Panel.
4. Disconnect wiring from Moisture Sensor.



5. Remove three screws inside drum retaining Blower Duct.



6. To remove Thermistor or Thermostat, disconnect wiring from component(s) and remove retaining screws.



7. Remove nine screws retaining Blower Cover panel.

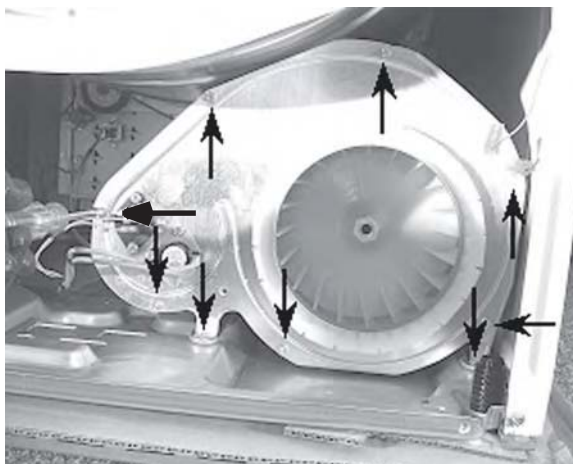

Disassembly Procedures

 **WARNING**

To avoid risk of electrical shock, personal injury or death; disconnect power to unit and shut off gas supply before performing any disassembly procedure.

8. Remove Blower Cover Panel.



9. Disconnect Motor Harness connector from Motor.
10. Rotate Blower Assembly as shown to remove from dryer.



11. Remove Blower Wheel by placing a wrench on the rear of the Motor shaft and the nut on the Blower Wheel. Rotate counterclockwise to loosen.



12. Remove three screws from Blower Scroll.



13. Remove Motor locking collar front and back to remove Motor.



Disassembly Procedures



WARNING

To avoid risk of electrical shock, personal injury or death; disconnect power to unit and shut off gas supply before performing any disassembly procedure.

Drum Removal / Roller / Glide Access

1. Disconnect power supply to unit.
2. Remove Top Cover and Front Panel, see "Top Cover / Door Switch / Front Panel / Gasket Removal" procedure.
3. Remove wires from light, see "Light Removal" procedure steps 3 - 4.
4. Remove four screws on Front Bulkhead.

5. Remove belt from Idler Pulley.
6. Grasp the Drum with one hand and the belt with the other. Lift the Drum and slide out the front. Carefully spread the cabinet as needed to gain additional clearance.
7. Rear Rollers and Glides can be serviced as needed.

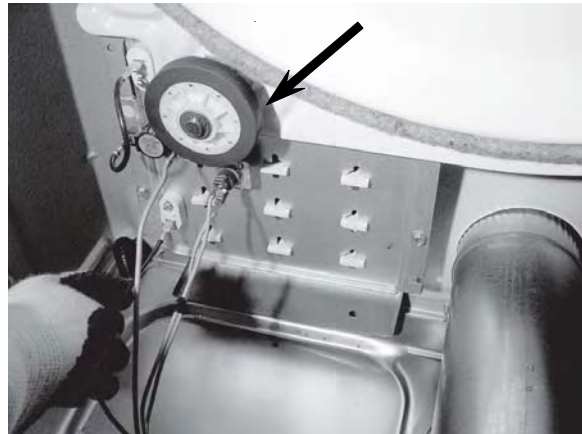
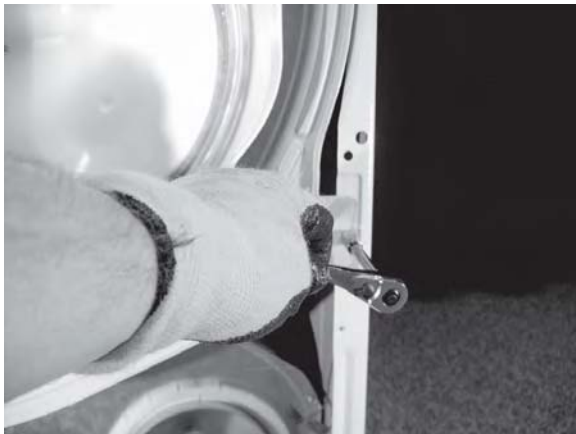
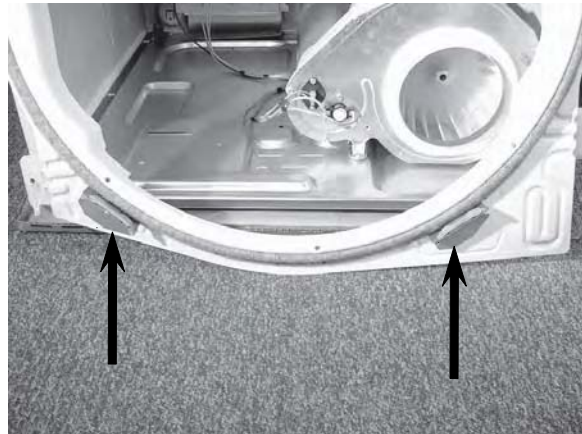
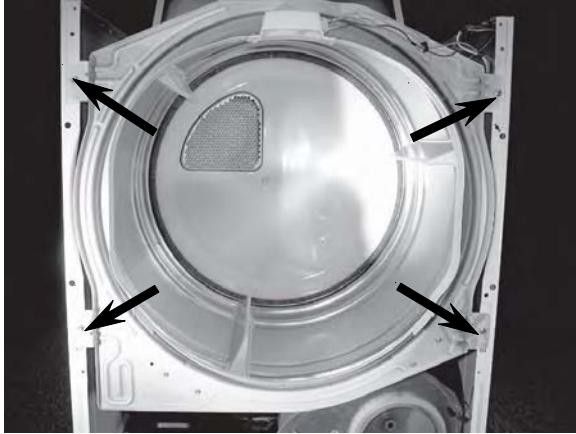

Disassembly Procedures

 WARNING
--

To avoid risk of electrical shock, personal injury or death; disconnect power to unit and shut off gas supply before performing any disassembly procedure.

Heater Removal

1. Disconnect power supply to unit.
2. Remove Top Cover and Front Panel, see "Top Cover / Door Switch / Front Panel / Gasket Removal" procedure.
3. Remove Belt from Idler Pulley.
4. Remove Drum.
5. Remove two screws securing Heater Assembly to rear bulkhead.

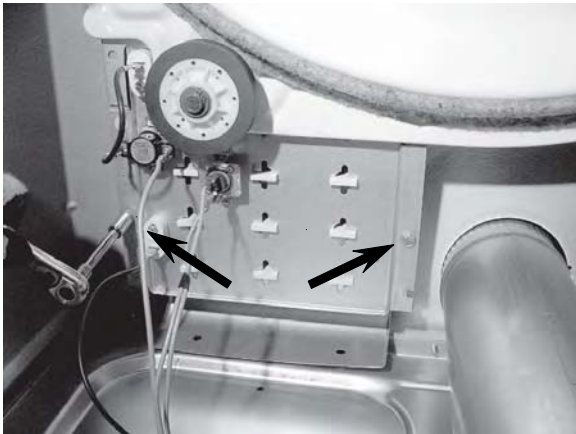

6. Disconnect wiring, drop Heater Assembly down and rotate out to remove.



Drum Baffle Removal

1. Disconnect power supply to unit.
2. Remove Top Cover, see "Top Cover / Door Switch / Front Panel / Gasket Removal" procedure.
3. Remove two screws retaining Drum Baffle.



Disassembly Procedures

! WARNING

To avoid risk of electrical shock, personal injury or death; disconnect power to unit and shut off gas supply before performing any disassembly procedure.

! WARNING

To avoid risk of personal injury or death; shut off gas supply to unit before servicing Burner Assembly.

NOTE: The Igniter Bar is fragile. Be careful not to damage Igniter when removing Burner Assembly.

Gas Model Disassembly

Igniter Removal

1. Disconnect power supply to unit.
2. Remove Top Cover.
3. Remove Console.
4. Remove Front Panel.
5. Loosen the single screw attaching the igniter to the Burner Assembly. Slide the Igniter back and remove.

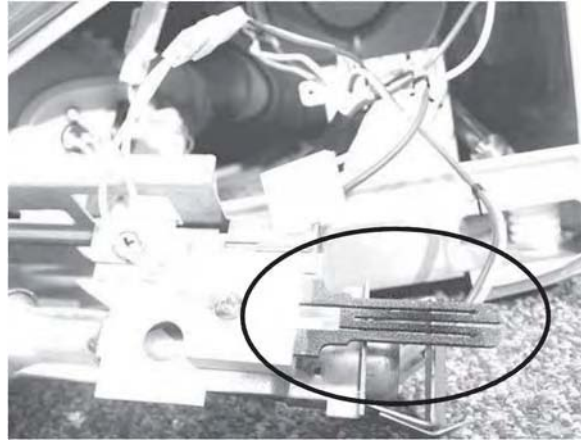

Burner Removal

1. Disconnect power supply to unit.
2. Shut off gas supply.
3. Disconnect incoming gas line to unit.
4. Remove two screws securing burner to bracket.

NOTE: The Igniter Bar is fragile. Be careful not to damage Igniter when removing Burner Assembly.

5. Remove the two screws attaching the housing to the burner bracket. The screws are recessed from view.

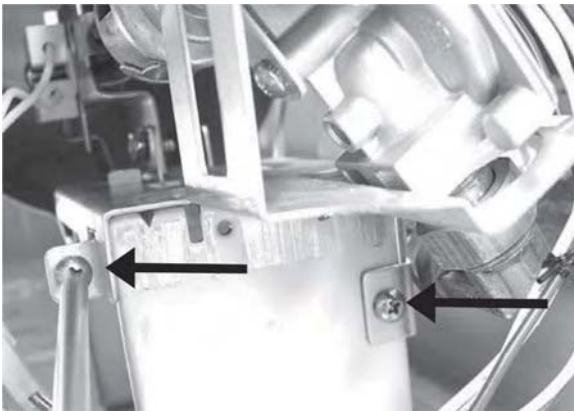

6. Slide Burner Assembly from dryer.



Appendix A

NOTES



Installation Instructions

Electric Dryer

*Keep instructions for future reference.
Be sure manual stays with dryer.*

*Questions?
See the User's Guide or
call Maytag Appliances
Sales Company*

1-800-688-9900 USA

1-800-688-2002

Canada

1-800-688-2080

TTY USA Only

You'll Need a Few Things Before You Begin

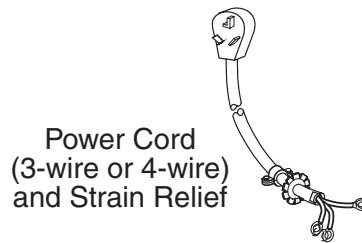

Power Cord
(3-wire or 4-wire)
and Strain Relief

Screws
(supplied)

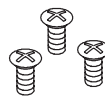

Duct Tape



Wrench

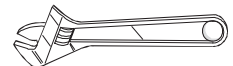

Screw
Drivers

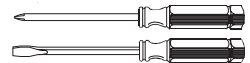

Level

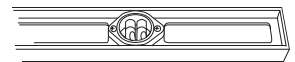

1 REMOVE PARTS AND CLEAN DRYER DRUM

Wipe drum with clean rag and soap diluted in warm water to remove any oil used in manufacturing. Make a paste of laundry detergent and clean drum if necessary.

To reverse the direction that door opens, see the User's Guide.

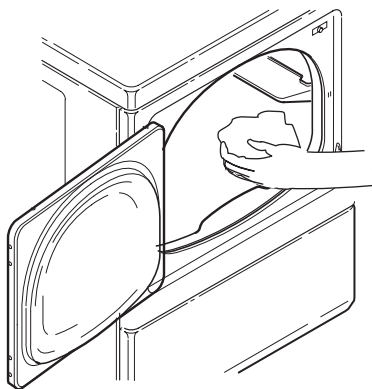

Optional Kits

Kits are available at extra cost through your Maytag dealer or Maytag Customer Assistance at 1-800-688-9900 USA 1-800-688-2002 Canada 1-800-688-2080 TTY USA Only

Directional Exhaust Kit

DK1 Sales Accessory (Directional Exhaust Kit #528P3).

Flexible Metal Vent Kit

Exhausting the dryer in hard-to-reach locations can be accomplished by installing Kit # 521P3.

2 CONNECT DRYER TO EXHAUST SYSTEM

Secure all joints with clamps or duct tape. DO NOT use sheet metal screws or other fastening means which extend into the duct to attach exhaust pipe joints. They could catch lint and reduce the efficiency of the exhaust system.

IMPORTANT: Keep exhaust duct as short as possible.

Be sure old ducts are clean before installing your new dryer.

To prevent backdraft when dryer is not in operation, outer end of exhaust pipe must have a weather hood with hinged dampers (obtain locally).

Weather hood should be installed at least 12" (30.5 cm) above the ground. Higher clearances may be necessary in areas where heavy snowfall can occur.

No extra system length consideration is necessary when exhausting through the roof. Use MAXIMUM EXHAUST LENGTH table to calculate system length. Use a roof cap that provides air flow equal to weather hood.

Exhaust Directions

Dryer can be exhausted to the outdoors through the back, left, right or bottom of the dryer.

Dryer is shipped from factory ready for rear exhaust. No kits required.

To exhaust dryer through sides or bottom, install a DK1 Sales Accessory (Directional Exhaust Kit 528P3). Available as optional equipment at extra cost.

Exhaust System Materials

Exhaust duct must be four inches (10.2 cm) in diameter without obstructions. Rigid metal duct is recommended. Non-combustible semi-rigid flexible metal duct is acceptable.

DO NOT use plastic pipe, foil pipe, or flexible plastic pipe, because it contributes to poor drying performance and collects lint, which can lead to a fire hazard. To identify flexible foil or plastic duct, pinch the coils of the duct between your fingers. If the coils can be brought together, do not use the duct.

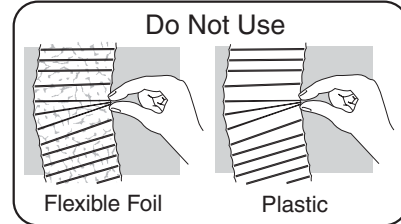
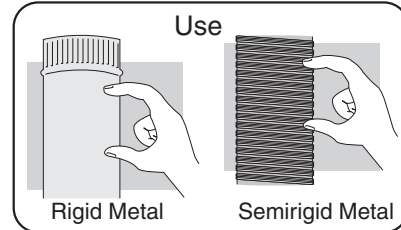

Maximum Exhaust Length

Rigid Metal Duct

Number of 90° Elbows	Weather Hood 4-inch Opening	Weather Hood 2½-inch Opening
0	44 feet (13.4 m)	34 feet (10.4 m)
1	34 feet (10.4 m)	26 feet (7.9 m)
2	26 feet (7.9 m)	20 feet (6.1 m)
3	20 feet (6.1 m)	14 feet (4.3 m)

Flexible Metal Duct

Number of 90° Elbows	Weather Hood 4-inch Opening	Weather Hood 2½-inch Opening
0	24 feet (7.3 m)	20 feet (6.1 m)
1	20 feet (6.1 m)	16 feet (4.9 m)
2	16 feet (4.9 m)	12 feet (3.7 m)
3	12 feet (3.7 m)	8 feet (2.4 m)

Recommended Weather Hood

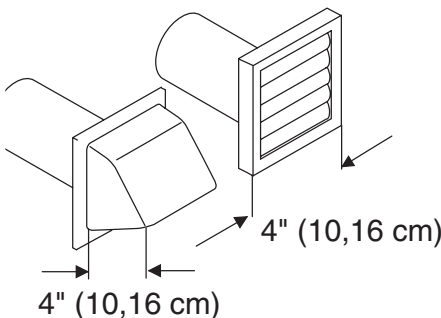

Recommended for Short Runs Only

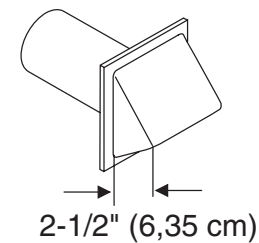

3 CONNECT ELECTRICAL CORD

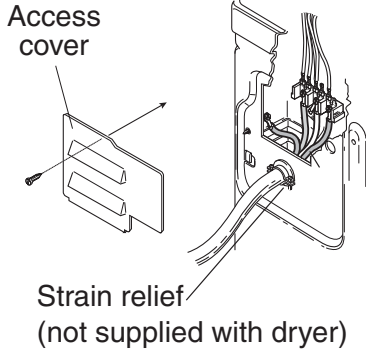

3-wire or 4-wire Plug Connection

Four-wire cord is required for mobile homes or where codes do not permit grounding through neutral.

1. Remove access cover from rear of dryer.
2. Use a strain relief and insert end of power cord through power supply hole.
3. Use the three screws from envelope located in the drum to attach the remaining power cord wires to the terminal block as follows:
 - Red wire to "L1" terminal.
 - Black wire to "L2" terminal.

- White wire to Neutral terminal.
 - **4-wire Plug Only**—Remove ground screw and detach ground wire from bulkhead. Attach power cord ground (green) wire to rear bulkhead using ground screw. Attach free ground wire, previously attached with ground screw, with white wire to the neutral (center) terminal on the terminal block.
4. Tighten all screws and reinstall access cover removed in step 1.

3-wire Cord Installed

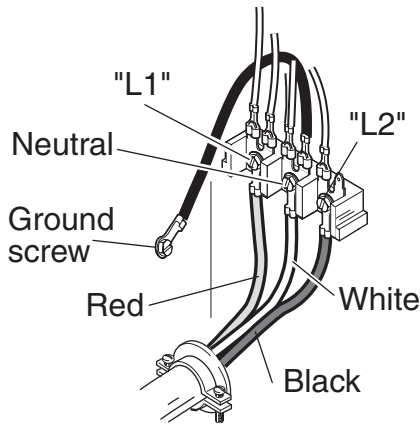

4-wire Cord Installed

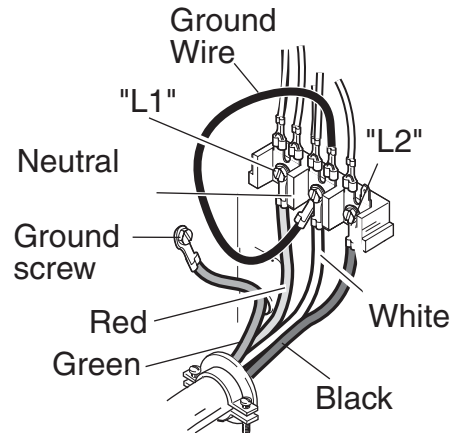

4 POSITION AND LEVEL DRYER

Place dryer in position, adjust all legs (4) until dryer is level side to side and front to back.

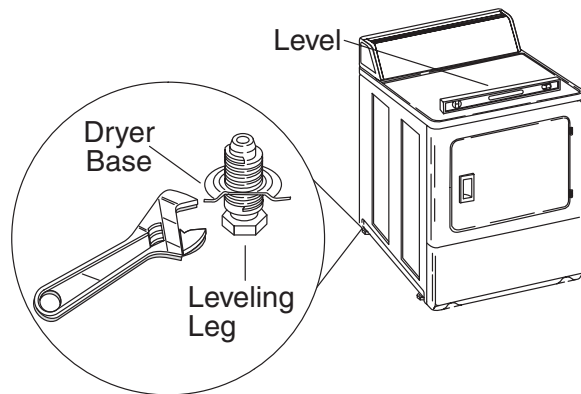

Important Safety Information

About Ground Wires

In the event of an electrical short circuit, a ground wire reduces the risk of electric shock by providing an escape wire for the electric current.

Standard accepted color coding for ground wires is **green or green with a yellow stripe**.

Grounding wires and wires colored like grounding wires are **NOT** to be used as current carrying conductors.

▲ WARNING

To reduce the risk of fire, the dryer **MUST** be exhausted to the outdoors. **DO NOT** exhaust dryer air into a window well, gas vent, chimney or enclosed, unventilated area, such as an attic, wall, ceiling, crawl space under a building or concealed space of a building.

▲ WARNING

To reduce the risk of fire, **DO NOT** use plastic pipe, foil pipe, or flexible plastic pipe to exhaust the dryer. Never install flexible duct in concealed spaces, such as a wall or ceiling.

▲ WARNING

To avoid risk of personal injury or death:

- Do not allow children to play on or in the appliance. Close supervision of children is necessary when the appliance is used near children.

▲ WARNING

To avoid injury or death due to suffocation, remove door to dryer compartment before appliance is removed from service or discarded.

Grounding Instructions

This dryer must be connected to a grounded metal, permanent wiring system, or an equipment-grounding conductor must be run with the circuit conductors and connected to the equipment-grounding terminal or lead on the dryer.

- Power cord (pigtail) is not supplied with electric dryer. Type of pigtail and gauge of wire must conform to local codes and instructions.

Method of wiring dryer is optional and subject to local code requirements.

- Connect dryer to power supply with **MAXIMUM RATED VOLTAGE** listed on the nameplate.
- Use copper wire only. Shorter than 15' (4.5 m) use 10 A.W.G. Longer than 15' (4.5 m) use 8 A.W.G.

▲ WARNING

To avoid risk of personal injury or death due to electrical shock:

- **Observe all local codes and ordinances.**
- Disconnect electrical power to unit before servicing.
- Ground appliance properly.
- Check with a qualified electrician if you are not sure this appliance is properly grounded.
- **DO NOT** ground to gas line.
- **DO NOT** ground to cold water pipe if pipe is interrupted by plastic, non-metallic gaskets or other insulating (non-conducting) materials.
- **DO NOT** modify plug on power cord. If plug does not fit electrical outlet, have proper outlet installed by qualified electrician.
- **DO NOT** have a fuse in the neutral or ground circuit. A fuse in the neutral or ground circuit could result in an electrical shock.
- **DO NOT** use an extension cord with this appliance.
- **DO NOT** use an adapter plug with this appliance.
- **DO NOT** pinch power cord.

▲ WARNING

To reduce the risk of fire, electric shock, serious injury or death, all wiring and grounding must conform with the latest edition of the National Electric Code, ANSI/NFPA 70, or the Canadian Electrical Code, CSA C22.1, and such local regulations as might apply. It is the customer's responsibility to have the wiring and fuses checked by a qualified electrician to make sure your home has adequate electrical power to operate the dryer.

Save These Instructions

Installation Requirements

Before You Install...

Consider	Description
Location	<p>Use dimensions shown in manual to determine space needed for installation.</p> <p>Place dryer on a solid floor in an area with an adequate air supply. A closet door must have a supply air vent of 80 sq. in. (517 sq. cm) minimum.</p> <p>Leveling legs can be adjusted from inside the dryer with a ¼" driver. All four legs must rest firmly on the floor so the weight of the dryer is evenly distributed. The dryer must not rock.</p> <p>Dryer must not be installed or stored in an area where it will be exposed to water and/or weather.</p>
Electrical Requirements	<p>Dryer needs a 3- or 4-wire 120/240 volt, 30 amp, 60 hertz, 1 phase electrical supply. Refer to serial plate for specific requirements. Wiring diagram is located in control hood.</p>
Exhaust	<p>Use rigid or semi-rigid duct and exhaust the dryer to the outside by the shortest route possible. Failure to exhaust dryer properly will void warranty.</p> <ul style="list-style-type: none"> • Dryer exhaust duct must be secured to the mobile home structure. Dryer exhaust MUST NOT terminate under the mobile home. • Exhaust duct must not be connected to any other duct, vent or chimney. • Venting materials are not supplied with the dryer (obtain locally). Do not use plastic or thin foil flexible ducting. • Static pressure in the dryer's exhaust duct should be no greater than .6 inches (1.5 cm). Check with dryer running and no load. This can be measured with a manometer placed on the exhaust duct approximately two feet (61 cm) from the dryer. <p>For the best exhaust system:</p> <ul style="list-style-type: none"> • Locate dryer so exhaust duct is as short as possible. • Verify old ducts are cleaned before installing new dryer. • Use 4 inch (10.2 cm) diameter rigid or flexible metal duct. • Use duct tape on all joints. • Use as few elbows as possible.

Dryer Dimensions and Minimum Clearances

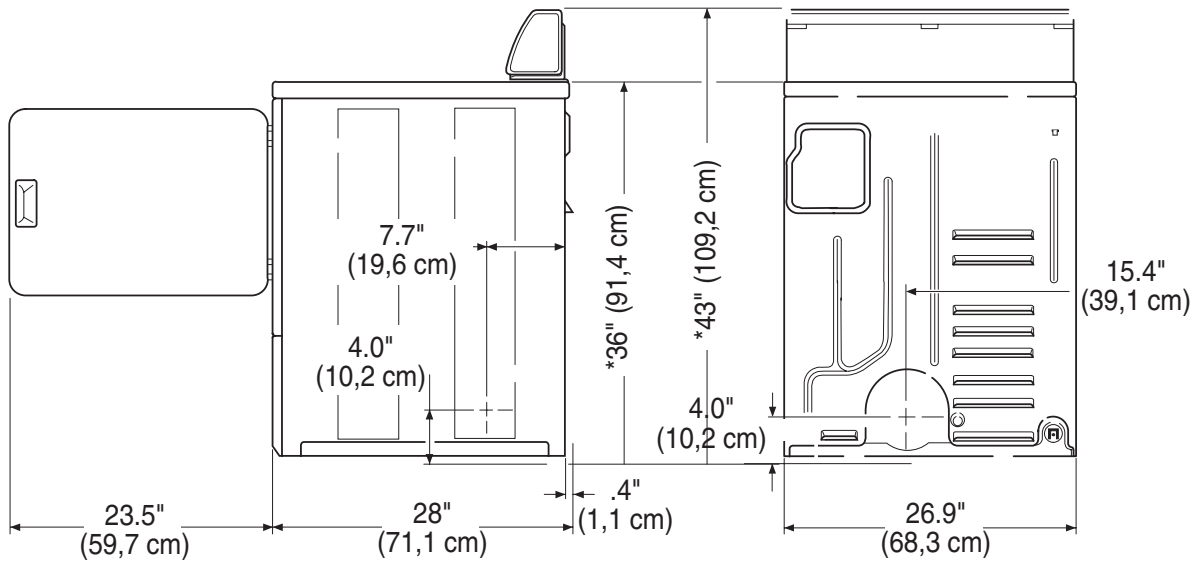

*With leveling legs turned fully into base

**FRONT VIEW
(w/o Closet Door)**

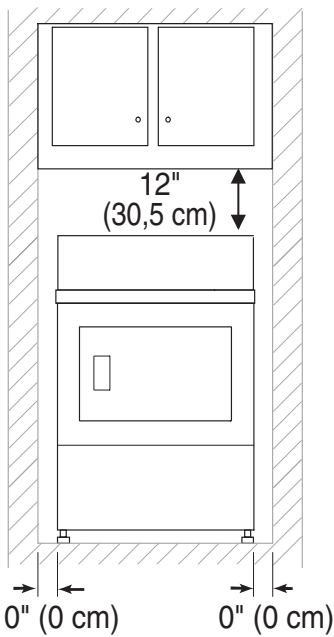

SIDE VIEW

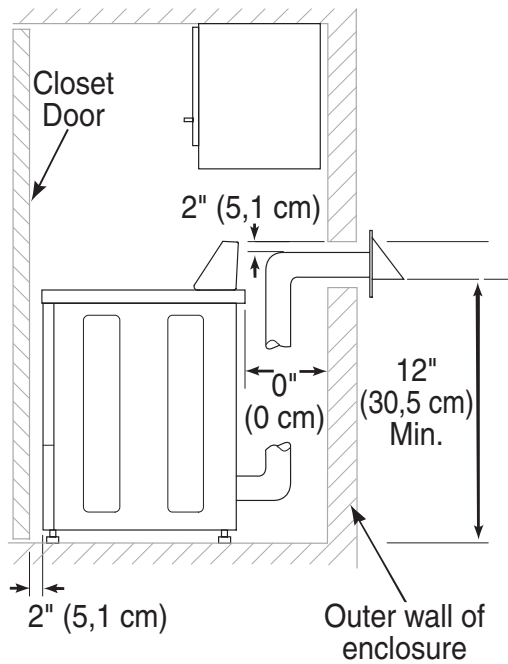

**FRONT VIEW
(Closet Door)**

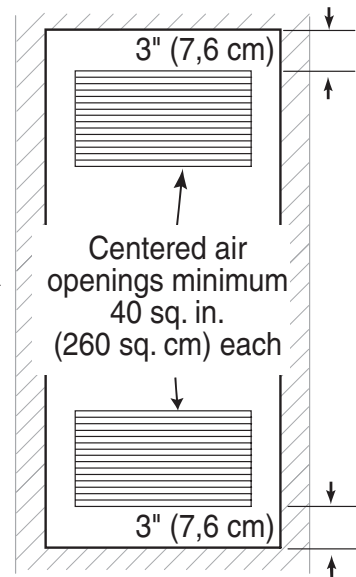



Installation Instructions

Gas Dryer

*Keep instructions for future reference.
Be sure manual stays with dryer.*

*Questions?
See the User's Guide or
call Maytag Appliances
Sales Company*

1-800-688-9900 USA

1-800-688-2002

Canada

1-800-688-2080

TTY USA Only

You'll Need a Few Things Before You Begin

Stainless Steel
or Hard Pipe
Gas Connector

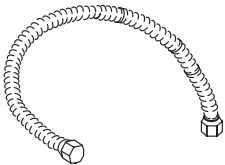

Duct Tape



Wrench

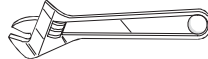

Teflon Tape or
Joint Compound



Screw
Drivers

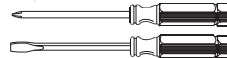

Level

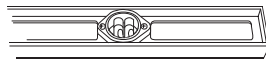

Optional Kits

Kits are available at extra cost through your Maytag dealer or Maytag Customer Assistance at
1-800-688-9900 USA
1-800-688-2002 Canada
1-800-688-2080 TTY USA Only

Directional Exhaust Kit

DK1 Sales Accessory (Directional Exhaust Kit #528P3).

Flexible Metal Vent Kit

Exhausting the dryer in hard-to-reach locations can be accomplished by installing Kit # 521P3.

Manufactured (Mobile) Home Installation Kit

Manufactured home anchor Kit #526P3.

Propane Gas Conversion Kit

LPK1 Sales Accessory (L.P./Propane Kit # 649P3).

1 REMOVE PARTS AND CLEAN DRYER DRUM

Wipe drum with clean rag and soap diluted in warm water to remove any oil used in manufacturing. Make a paste of laundry detergent and clean drum if necessary.

To reverse the direction that the door opens, see the User's Guide.

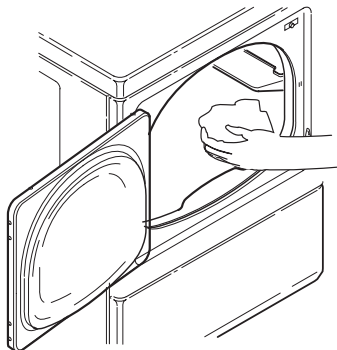

2 CONNECT DRYER TO EXHAUST SYSTEM

Secure all joints with clamps or duct tape. DO NOT use sheet metal screws or other fastening means which extend into the duct to attach exhaust pipe joints. They could catch lint and reduce the efficiency of the exhaust system.

IMPORTANT: Keep exhaust duct as short as possible.

Be sure old ducts are clean before installing your new dryer.

To prevent backdraft when dryer is not in operation, outer end of exhaust pipe must have a weather hood with hinged dampers (obtain locally).

Weather hood should be installed at least 12" (30.5 cm) above the ground. Higher clearances may be necessary in areas where heavy snowfall can occur.

No extra system length consideration is necessary when exhausting through the roof. Use *MAXIMUM EXHAUST LENGTH* table to calculate system length. Use a roof cap that provides air flow equal to weather hood.

Exhaust Directions

Dryer can be exhausted to the outdoors through the back, right, or bottom of the dryer. **Gas dryers cannot be vented out the left side because of the burner housing.**

Dryer is shipped from factory ready for rear exhaust. No kits required.

To exhaust dryer through sides or bottom, install a DK1 Sales Accessory (Directional Exhaust Kit 528P3). Available as optional equipment at extra cost.

Exhaust System Materials

Exhaust duct must be four inches (10.2 cm) in diameter without obstructions. Rigid metal duct is recommended. Non-combustible semirigid flexible metal duct is acceptable.

DO NOT use plastic pipe, foil pipe, or flexible plastic pipe, because it contributes to poor drying performance and collects lint, which can lead to a fire hazard. To identify flexible foil or plastic duct, pinch the coils of the duct between your fingers. If the coils can be brought together, do not use the duct.

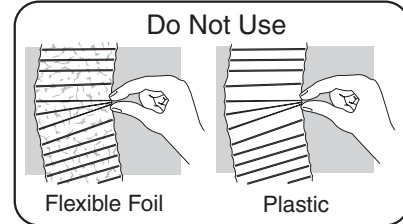
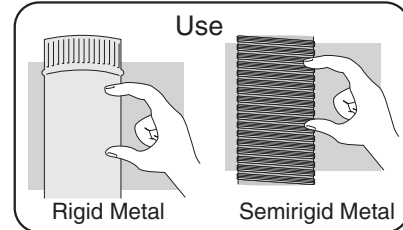

Maximum Exhaust Length

Rigid Metal Duct

Number of 90° Elbows	Weather Hood 4-inch Opening	Weather Hood 2½-inch Opening
0	44 feet (13.4 m)	34 feet (10.4 m)
1	34 feet (10.4 m)	26 feet (7.9 m)
2	26 feet (7.9 m)	20 feet (6.1 m)
3	20 feet (6.1 m)	14 feet (4.3 m)

Flexible Metal Duct

Number of 90° Elbows	Weather Hood 4-inch Opening	Weather Hood 2½-inch Opening
0	24 feet (7.3 m)	20 feet (6.1 m)
1	20 feet (6.1 m)	16 feet (4.9 m)
2	16 feet (4.9 m)	12 feet (3.7 m)
3	12 feet (3.7 m)	8 feet (2.4 m)

Recommended Weather Hood

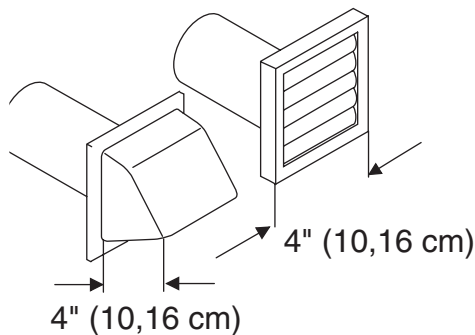

Recommended for Short Runs Only

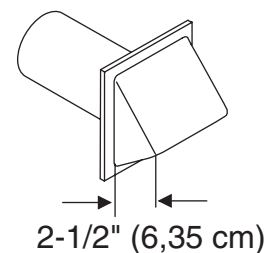

3 CONNECT GAS SUPPLY

L.P./Propane

DO NOT connect dryer to L.P./Propane gas service without converting the gas valve. An LPK1 Sales Accessory L.P./Propane Gas Conversion Kit 649P3 must be installed.

Test for Gas Leaks

After final gas connection is made, turn on manual gas valve and test all connections in gas supply piping for gas leaks. Leak testing of the appliance shall be conducted according to the manufacturer's instructions.



1. Place soap suds on connections.
2. If bubbles appear, a leak is present. Shut off gas supply valve.
3. Tighten joint if leak is at factory fitting.
 - If leak is not at factory fitting, unscrew, apply more joint compound, and tighten to correct leak.
4. Retest connection for leak after tightening or adding joint compound.
 - Retest any connections that were disturbed.

Connect gas supply to dryer using a new stainless steel flexible connector or hard pipe (check local codes) according to illustration. Test for leaks and check burner flame after gas supply is connected. See Checking Burner Flame section on back page.

- Dryer must be connected to type of gas as shown on nameplate located in the door recess.

- Use pipe joint compound insoluble on LP (propane) Gas, or Teflon tape, on all pipe threads.
- Purge air and sediment from gas supply line before connecting it to the dryer. Before tightening the connection, purge remaining air from gas line to dryer until odor of gas is detected. This step is required to prevent gas valve contamination.

Use new stainless steel flexible connector only if allowed by local codes (use Design A.G.A. certified connector)

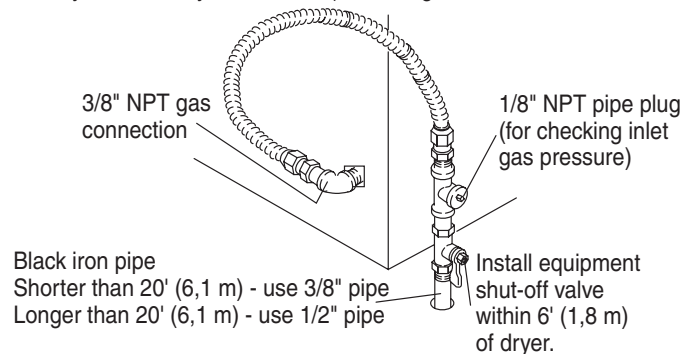

For proper operation at altitudes above 2,500 feet

The natural gas valve spud orifice size must be reduced to ensure complete combustion. See table.

Altitude Ft. (M)	Orifice Size #	Part Number
3000 (915)	43	503778
6000 (1830)	44	58719
8000 (2440)	45	503779
9000 (2740)	46	503780
10000 (3050)	47	503781

4 CONNECT POWER CORD TO ELECTRICITY

See Installation Requirements section. Plug dryer into **3-prong grounded outlet only**.

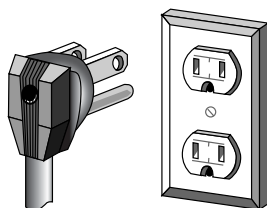

5 POSITION AND LEVEL DRYER

Place dryer in position, adjust all legs (4) until dryer is level side to side and front to back.

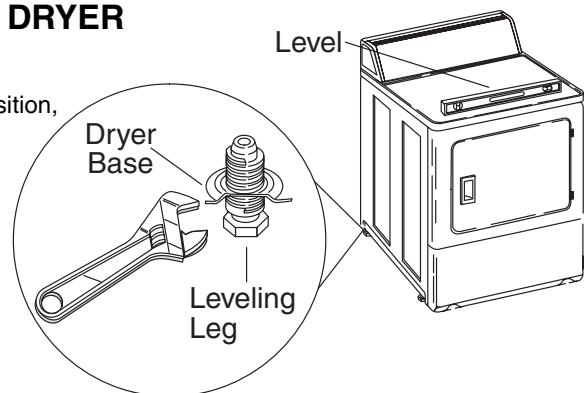

Important Safety Information

About Ground Wires

In the event of an electrical short circuit, a ground wire reduces the risk of electric shock by providing an escape wire for the electric current.

Standard accepted color coding for ground wires is **green or green with a yellow stripe**.

Grounding wires and wires colored like grounding wires are **NOT** to be used as current carrying conductors.

▲ WARNING

To reduce the risk of fire, the dryer **MUST** be exhausted to the outdoors. **DO NOT** exhaust dryer air into a window well, gas vent, chimney or enclosed, unventilated area, such as an attic, wall, ceiling, crawl space under a building or concealed space of a building.

▲ WARNING

To reduce the risk of fire, **DO NOT** use plastic pipe, foil pipe, or flexible plastic pipe to exhaust the dryer. Never install flexible duct in concealed spaces, such as a wall or ceiling.

▲ WARNING

To reduce the risk of fire, electric shock, serious injury or death, all wiring and grounding must conform with the latest edition of the National Electric Code, ANSI/NFPA 70, or the Canadian Electrical Code, CSA C22.1, and such local regulations as might apply. It is the customer's responsibility to have the wiring and fuses checked by a qualified electrician to make sure your home has adequate electrical power to operate the dryer.

Grounding Instructions

Dryer must be grounded. Dryer is equipped with a cord having a grounding conductor and a 3-prong grounding plug. The three-prong grounding plug on the power cord should be plugged directly into a polarized three-slot grounded receptacle rated 110/120V AC (alternating current) 15 Amps.

▲ WARNING

To avoid risk of personal injury or death due to electrical shock:

- **Observe all local codes and ordinances.**
- Disconnect electrical power to unit before servicing.
- Ground appliance properly.
- Check with a qualified electrician if you are not sure this appliance is properly grounded.
- **DO NOT** ground to gas line.
- **DO NOT** ground to cold water pipe if pipe is interrupted by plastic, non-metallic gaskets or other insulating (non-conducting) materials.
- **DO NOT** modify plug on power cord. If plug does not fit electrical outlet, have proper outlet installed by qualified electrician.
- **DO NOT** have a fuse in the neutral or ground circuit. A fuse in the neutral or ground circuit could result in an electrical shock.
- **DO NOT** use an extension cord with this appliance.
- **DO NOT** use an adapter plug with this appliance.
- **DO NOT** pinch power cord.

▲ WARNING

To avoid death, personal injury or property damage, from fire or explosion, information in this manual must be followed exactly:

- Do not store or use gasoline or other flammable vapors and liquids in the vicinity of this or any other appliance.
- **WHAT TO DO IF YOU SMELL GAS**
 - Do not try to light any appliance.
 - Do not touch any electrical switch; do not use any phone in your building.
 - Immediately call your gas supplier from a neighbor's phone. Follow the gas supplier's instructions.
 - If you cannot reach your gas supplier, call the fire department.
- Installation and service must be performed by a qualified installer, service agency or the gas supplier.

Save These Instructions

Installation Requirements

Before You Install...

Consider	Description
Location	<p>Use dimensions shown in manual to determine space needed for installation.</p> <p>Place dryer on a solid floor in an area with an adequate air supply. A closet door must have a supply air vent of 80 sq. in. (517 sq. cm) minimum.</p> <p>No other fuel burning appliance should be installed in the same closet with the dryer.</p> <p>Dryer must not be installed or stored in an area where it will be exposed to water and/or weather.</p> <p>Manufactured (mobile) home installation must conform to the Manufactured Home Construction and Safety Standards, Title 24 CFR, Part 32-80 or Standard CAN/CSA-Z240 MH.</p> <p>Gas dryers must be permanently attached to the floor at the time of installation. Order No. 526P3 Dryer Installation Kit for a manufactured (mobile) home installation.</p>
Electrical Requirements	<p>Dryer requires 120 volt, 15 amp, 60 Hz power supply and 3-prong grounding plug. Power cord is approximately 69" long. Do not operate other appliances on the same circuit when this appliance is operating. Refer to serial plate for specific requirements. Wiring diagram is located in control hood.</p>
Gas	<p>Natural Gas Pressure, 1000 Btu/ft³ (37.3 MJ/m³), service must be supplied at 6.5 + 1.5 inch water column pressure. L.P. (propane) Gas Pressure, 2,500 Btu/ft³ (93.1 MJ/m³), service must be supplied at 10 + 1.5 inch water column pressure.</p> <p>NOTE: The dryer and its appliance main gas valve must be disconnected from the gas supply piping system during any pressure testing of that system at test pressures in excess of 1/2 psi (3.45 kPa). Dryer must be isolated from the gas supply piping system by closing the equipment shut-off valve during any pressure testing of the gas supply piping system at test pressures equal to or less than 1/2 psi (3,45 kPa).</p> <p>When connecting to a gas line, an equipment shutoff valve must be installed within 6' (1.8 m) of the dryer. An 1/8" N.P.T. pipe plug must be installed.</p> <p>The gas service to a gas dryer must conform with the local codes and ordinances or in the absence of local codes and ordinances, with the latest edition of the National Fuel Gas Code ANSIZ223.1/NFPA 54 or the CAN/CGA-B149, National Gas Installation Code. LPK1 Sales Accessory (L.P./Propane Gas Conversion Kit 649P3) must be installed. DO NOT connect dryer to L.P./Propane Gas Service without converting the gas valve.</p>
Exhaust	<p>Use rigid or semi-rigid duct and exhaust the dryer to the outside by the shortest route possible. Failure to exhaust dryer properly will void warranty.</p> <ul style="list-style-type: none"> • Dryer exhaust duct must be secured to the mobile home structure. Dryer exhaust MUST NOT terminate under the mobile home. • Exhaust duct must not be connected to any other duct, vent or chimney. • Venting materials are not supplied with the dryer (obtain locally). Do not use plastic or thin foil flexible ducting. • Static pressure in the dryer's exhaust duct should be no greater than .6 inches (1.5 cm). Check with dryer running and no load. This can be measured with a manometer placed on the exhaust duct approximately two feet (61 cm) from the dryer. <p>For the best exhaust system:</p> <ul style="list-style-type: none"> • Locate dryer so exhaust duct is as short as possible. • Verify old ducts are cleaned before installing new dryer. • Use 4 inch (10.2 cm) diameter rigid or flexible metal duct. • Use duct tape on all joints. • Use as few elbows as possible.

Installation Checks and Adjustments

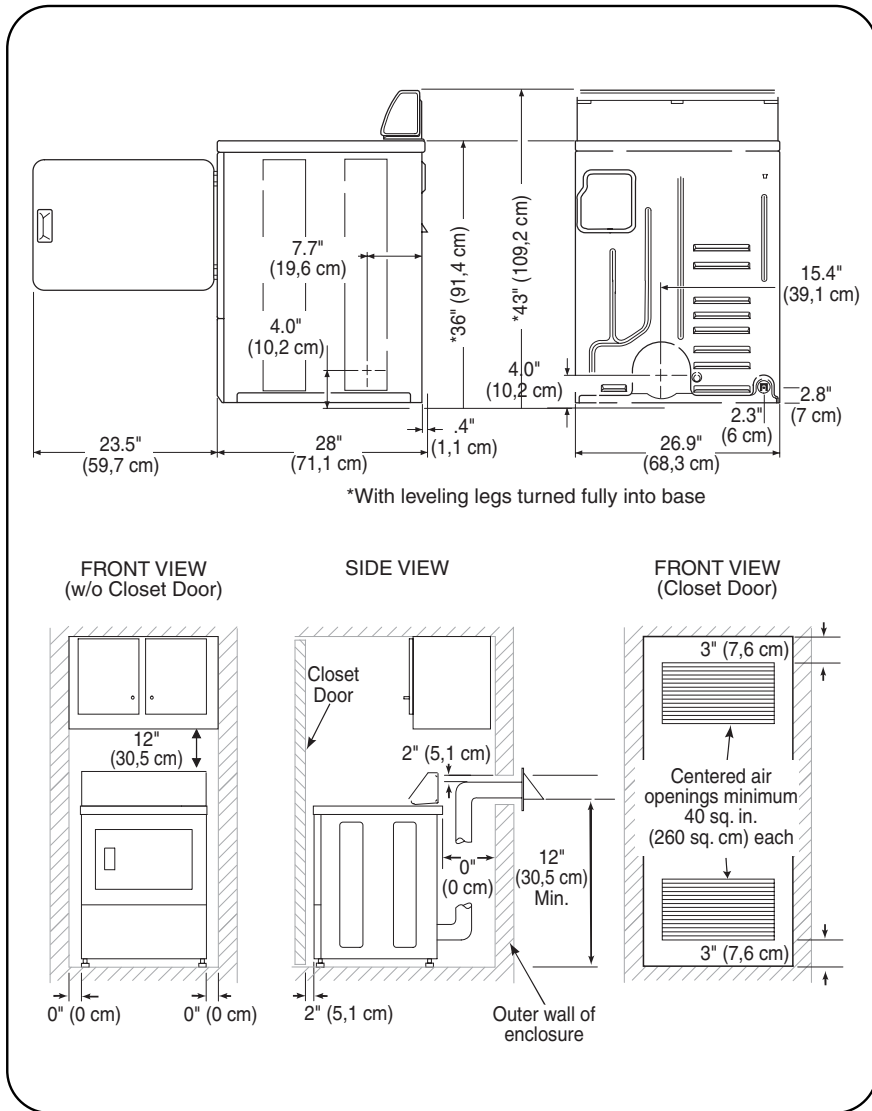

Checking Burner Flame

To view the burner flame, remove the lower front panel of the dryer.

⚠ WARNING

To prevent personal injury or property damage, front panel must be in place during normal operation.

Close the loading door, start the dryer in a heat setting (refer to User's Guide) The dryer will start, ignitor will glow red, and main burner will ignite.

IMPORTANT: If all air is not purged out of gas line, gas ignitor may go off before gas is ignited. If this happens, after approximately two minutes ignitor will again attempt gas ignition.

After the dryer has operated for approximately 5 minutes, observe burner flame through lower front panel. Adjust air shutter to obtain a soft, uniform blue flame. (A lazy, yellow tipped flame indicates lack of air. A harsh, roaring, very blue flame indicates too much air.)

Adjusting Air Flow to Burner

1. Loosen air shutter lock screw.
2. Turn air shutter to left to get a luminous yellow-tipped flame, turn it back slowly to the right to obtain a steady, soft blue flame.
3. After air shutter is adjusted for proper flame, tighten air shutter lock screw securely.

After the dryer has operated for approximately three minutes, exhaust air or exhaust pipe should be warm.

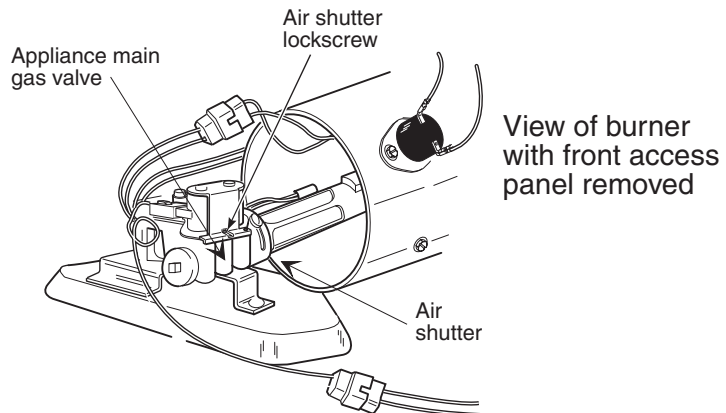

Appendix B

The Use and Care information provided in this service manual is representative of a limited number of models. Reference the customer's Use and Care literature included with the product, order a copy, or consult the manufacturer's website for the specific model (www.maytag.com).







Notes



Dryer

Use & Care Guide

Table of Contents

	Important Safety Instructions1-2
	Using the Controls
	Auto Dry Models3-4
	Sensor Models5-6
	Electronic Controls7-9
	Operating Tips 10
	Accessories 10
	Care & Cleaning 11

	Reversing the Door 12
	Dryer Exhaust Tips 13
	Troubleshooting 14
	



Important Safety Instructions

Installer: Please leave this guide with this appliance.

Consumer: Please read and keep this guide for future reference. Keep sales receipt and/or canceled check as proof of purchase.

Model Number _____

Serial Number _____

Date of Purchase _____

If you have questions, call:

Maytag Customer Assistance
1-800-688-9900 U.S.A.
1-800-688-2002 Canada
(Mon.-Fri. 8 a.m.-8 p.m. Eastern Time)
Internet: <http://www.maytag.com>

U.S.A. Customers using TTY for deaf, hearing impaired or speech impaired, call 1-800-688-2080.

In our continuing effort to improve the quality and performance of our appliances, it may be necessary to make changes to the appliance without revising this guide.

For service information, see page 15.

What You Need to Know About Safety Instructions

Warning and Important Safety Instructions appearing in this guide are not meant to cover all possible conditions and situations that may occur. Common sense, caution and care must be exercised when installing, maintaining or operating appliance.

Always contact the manufacturer about problems or conditions you do not understand.

Recognize Safety Symbols, Words, Labels

WARNING

WARNING – Hazards or unsafe practices which **COULD** result in severe personal injury or death.

CAUTION

CAUTION – Hazards or unsafe practices which **COULD** result in minor personal injury.

WARNING

For your safety, the information in this guide must be followed to minimize the risk of fire or explosion or to prevent property damage, personal injury or death.

- Do not store or use gasoline or other flammable vapors and liquids in the vicinity of this or any other appliance.

WHAT TO DO IF YOU SMELL GAS

- Do not try to light any appliance.
- Do not touch any electrical switch.
- Do not use any phone in your building.
- Clear the room, building or area of all occupants.
- Immediately call your gas supplier from a neighbor's phone. Follow the gas supplier's instructions.
- If you cannot reach your gas supplier, call the fire department.

Installation and service must be performed by a qualified installer, service agency or the gas supplier.

WARNING! FIRE HAZARD

Do not place into your dryer items that have been spotted or soaked with vegetable oil or cooking oil. Even after being washed, these items may contain significant amounts of these oils. The remaining oil can ignite spontaneously. The potential for spontaneous ignition increases when the items containing vegetable oil or cooking oil are exposed to heat. Heat sources, such as your clothes dryer, can warm these items, allowing an oxidation reaction in the oil to occur. Oxidation creates heat. If this heat cannot escape, the items can become hot enough to catch fire. Piling, stacking or storing these kinds of items may prevent heat from escaping and can create a fire hazard.

All washed and unwashed fabrics that contain vegetable oil or cooking oil can be dangerous. Washing these items in hot water with extra detergent will reduce, but will not eliminate, the hazard. Always use the Cool Down cycle for these items to reduce the items' temperature. Never remove these items from the clothes dryer hot or interrupt the drying cycle until the items have run through the Cool Down cycle. Never pile or stack these items when they are hot.



Important Safety Instructions

WARNING

To reduce the risk of fire, explosion, electric shock, or personal injury when using your dryer, follow basic safety precautions, including the following:

1. Read all instructions before using the appliance.
2. To avoid the possibility of fire or explosion:
 - a. **Do not** dry items that have been previously cleaned in, washed in, soaked in, or spotted with gasoline, dry-cleaning solvents, other flammable or explosive substances as they give off vapors that could ignite or explode. Any material on which you have used a cleaning solvent, or which is saturated with flammable liquids or solids, should not be placed in the dryer, until all traces of these flammable liquids or solids and their fumes have been removed. There are many highly flammable items used in homes, such as: acetone, denatured alcohol, gasoline, kerosene, some liquid household cleaners, some spot removers, turpentine, waxes and wax removers.
 - b. Items containing foam rubber (may be labeled latex foam) or similarly textured rubber-like materials must not be dried on a heat setting. Foam rubber materials when heated, can under certain circumstances produce fire by spontaneous combustion.
3. **Do not** allow children or pets to play on, in, or in front of the appliance. Close supervision is necessary when the appliance is used near children and pets.
4. Before the appliance is removed from service or discarded, remove the door to the drying compartment.
5. **Do not** reach into the appliance if the drum is moving.
6. **Do not** install or store this appliance where it will be exposed to the weather.
7. **Do not** tamper with controls.
8. **Do not** repair or replace any part of the appliance or attempt any servicing unless specifically recommended in published user-repair instructions that you understand and have the skills to carry out.
9. **Do not** use fabric softeners or products to eliminate static unless recommended for dryer use

by the manufacturer of the fabric softener or product.

10. Clean the lint screen before or after each load.
11. Keep the area around the exhaust opening and surrounding areas free from lint accumulation, dust and dirt.
12. The interior of the dryer and exhaust duct should be cleaned periodically by qualified service personnel.
13. This appliance must be properly grounded. **Never** plug the appliance cord into a receptacle which is not grounded adequately and in accordance with local and national codes. See installation instructions for grounding this appliance.
14. **Do not** sit on top of the clothes dryer.

Important Safety Notice & Warning

The California Safe Drinking Water and Toxic Enforcement Act of 1986 (Proposition 65) requires the Governor of California to publish a list of substances known to the State of California to cause cancer or reproductive harm, and requires businesses to warn customers of potential exposures to such substances.

Users of this appliance are hereby warned that the burning of gas can result in low-level exposure to some of the listed substances, including benzene, formaldehyde, and soot, due primarily to the incomplete combustion of natural gas or liquid petroleum (LP) fuels. Exhaust ducts should be kept free of obstructions and properly exhausted dryers will minimize exposure.

WARNING

Gas leaks may occur in your system and result in a dangerous situation. Gas leaks may not be detected by smell alone. Gas suppliers recommend you purchase and install an UL approved gas detector. Install and use in accordance with the manufacturer's instructions.

Note: Because of continuing product improvements, Maytag reserves the right to change specifications without notice. For complete details, see the Installation Instructions packed with your product before selecting cabinetry, making cutouts or beginning installation.

SAVE THESE INSTRUCTIONS



Using the Controls - Auto Dry Models

STEP 1

Select Temperature

In order to select the correct temperature, turn the Temperature control to one of four choices: Regular, Medium (select models), Delicate or Air Fluff.

DRYER TEMPS	LOAD TYPE
Regular	Sturdy cottons or labels marked Tumble Dry.
Medium (select models)	For wrinkle-free/permanent press synthetics, lightweight cottons labeled Tumble Dry Medium.
Delicate	For heat sensitive items labeled Tumble Dry Low or Tumble Dry Medium.
Air Fluff	Items which need freshening. Load tumbles with room temperature air. Use the Time Dry/Air Fluff cycle.

STEP 2

Select Options

Extended Tumble (select models)

Extended Tumble is provided to minimize wrinkles in the Auto Dry Wrinkle Control cycle. This feature provides an extra 60 minutes of unheated tumble action at the end of the cycle. Clothes can be removed any time during this portion of the cycle.

The additional 60 minutes of unheated tumbling can be canceled by turning the switch to **Off**.

End of Cycle Signal

When the cycle is complete, a signal will sound. On select models, the End of Cycle Signal can be turned down or **Off**.

Remove load immediately to reduce wrinkling.

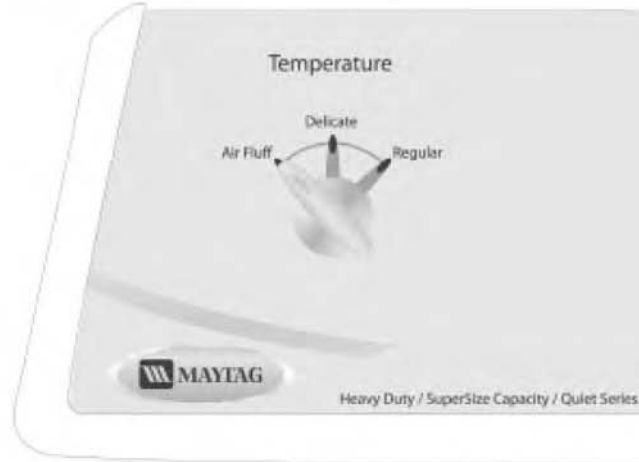

STEP 3

Select Cycle

To select a cycle, rotate the control dial to the desired setting. When using an Auto Dry cycle, the control dial should point between More Dry and Less Dry for most loads.

Loads of larger or bulkier size may require the More Dry setting to completely dry the load. The Less Dry setting is best suited for lightweight fabrics or for leaving some moisture in the clothing at the end of the cycle.

Auto Dry Regular

The Auto Dry Regular cycle is designed to dry most cottons and linens. At the end of the cycle, the clothes are cooled for approximately 10 minutes to reduce wrinkling.

Auto Dry Wrinkle Control

The Auto Dry Wrinkle Control cycle is designed to dry wrinkle-free cottons, synthetic fabrics, double knits and permanent press fabrics automatically. At the end of the cycle, the clothes are cooled for approximately 25 minutes to reduce wrinkling. If the load is not removed from the dryer and **Extended Tumble** (select models) has been selected, the cycle will advance to Extended Tumble which provides additional unheated tumbling time. (See Step 2).



Cycles and options may vary by model.

Time Dry/Air Fluff

This cycle can be used to regulate the drying time. Use with Air Fluff, Delicate, Medium (select models) or Regular temperature settings. For timed drying, turn the control dial until the pointer points to the proper time setting in the Time Dry/Air Fluff cycle.

Note: Using the Air Fluff temperature setting will require a longer drying time.

Damp Dry (select models)

Damp Dry is located on the Time Dry/Air Fluff section of the dial. It is designed to partially dry items and can be used with any temperature selection. Damp Dry will provide 20 minutes of tumbling time, followed by 10 minutes of cool-down tumbling.

STEP 4

Push the Control Dial in to Start

Push the control dial **in** to start the dryer. The dryer door must be closed for the dryer to start.

Note: The dial can be turned in either direction to select a cycle. Once started, the dial will not advance at a specific rate during the Auto Dry cycles. At first the dial may not advance at all. Toward the end of the cycle (when the load begins to dry), the dial will advance at a more regular rate and much more quickly. This is normal operation.



Using the Controls - Sensor Models

STEP 1

Select Temperature

In order to select the correct temperature, turn the Temperature control to one of four choices; Regular, Medium, Low or Air Fluff.

DRYER TEMPS	LOAD TYPE
Regular	Sturdy cottons or labels marked Tumble Dry.
Medium	For wrinkle-free/permanent press synthetics, lightweight cottons or items labeled Tumble Dry Medium.
Low	For heat sensitive items labeled Tumble Dry Low or Tumble Dry Medium.
Air Fluff	Items which need freshening. Load tumbles with room temperature air. Use the Time Dry/Air Fluff cycle.

STEP 2

Select Options

Extended Tumble

Extended Tumble is provided to minimize wrinkles in the Sensor Wrinkle Control cycle. This feature provides an extra 60 minutes of unheated tumble action at the end of the cycle. Clothes can be removed any time during this portion of the cycle.

The additional 60 minutes of unheated tumbling can be canceled by turning the knob to **Off** or opening the door.

End of Cycle Chime

When the cycle is complete, a chime will sound. The End of Cycle Chime can be turned off by turning the selector knob to **Off**.

Remove load immediately to reduce wrinkling.

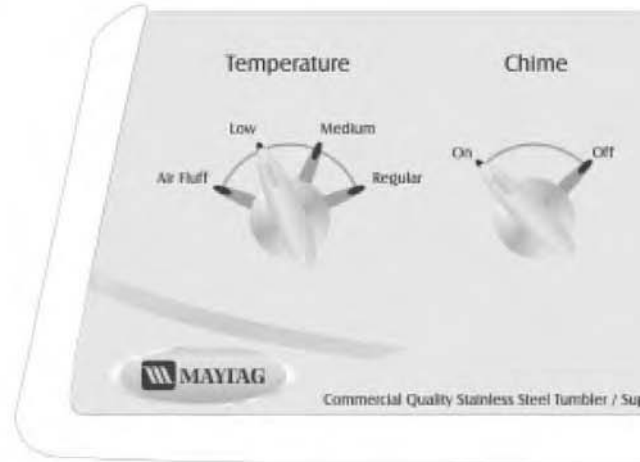

STEP 3

Select Cycle

To select a cycle, rotate the control dial to the desired setting. When using a Sensor Wrinkle Control cycle, the control dial should point between More Dry and Less Dry for most loads.

Loads of larger or bulkier size may require the More Dry setting to completely dry the load. The Less Dry setting is best suited for lightweight fabrics or for leaving some moisture in the clothing at the end of the cycle.

Sensor Regular

The Sensor Regular cycle is designed to dry most cottons and linens. At the end of the cycle, the clothes are cooled to reduce wrinkling.

Sensor Wrinkle Control

The Sensor Wrinkle Control cycle is designed to dry wrinkle-free cottons, synthetic fabrics, double knits and permanent press fabrics automatically. At the end of the cycle, the clothes are cooled. If the load is not removed from the dryer and **Extended Tumble** has been selected, the cycle will advance to Extended Tumble which provides additional unheated tumbling time. (See Step 2).



Cycles and options may vary by model.

Time Dry/Air Fluff

This cycle can be used to regulate the drying time. Use with Air Fluff, Low, Medium or Regular temperature settings. For timed drying, turn the control dial until the pointer points to the proper time setting in the Time Dry/Air Fluff cycle.

Note: Using the Air Fluff temperature setting will require a longer drying time.

Damp Dry (select models)

Damp Dry is located on the Time Dry/Air Fluff section of the dial. It is designed to partially dry items and can be used with any temperature selection. Damp Dry will provide 20 minutes of tumbling time, followed by 10 minutes of cool-down tumbling.

STEP 4

Push the Control Dial in to Start

Push the control dial **in** to start the dryer. The dryer door must be closed for the dryer to start.

Note: The dial can be turned in either direction to select a cycle. Once started, the dial will not advance at a specific rate during the Sensor cycles. At first the dial may not advance at all. Toward the end of the cycle (when the load begins to dry), the dial will advance at a more regular rate and much more quickly. This is normal operation.



Using the Controls - Electronic Controls

STEP 1

Select Temperature

Auto Temp (preferred setting)

When **Auto Temp** is selected, the dryer will automatically select the most appropriate drying temperature based on the cycle and dryness settings selected.

If you prefer not to use Auto Temp, turn the **temperature selector** knob to the desired setting.

DRYER TEMPS	LOAD TYPE
Regular	Sturdy cottons or labels marked Tumble Dry.
Medium	For wrinkle-free/permanent press synthetics, lightweight cottons or items labeled Tumble Dry Medium.
Low	For heat sensitive items labeled Tumble Dry Low or Tumble Dry Medium.
Air Fluff	Items which need freshening. Load tumbles with room temperature air. Use the Time Dry/Air Fluff cycle.

STEP 2

Select Options (if desired)

End of Cycle Chime

When the cycle is complete, an audible chime will sound. The chime will sound intermittently during Wrinkle Prevent. On select models, the volume of the chime can be adjusted. To turn the Chime off, turn the Chime selector knob to **Off**.

Wrinkle Prevent

Wrinkle Prevent provides approximately 95 minutes of intermittent tumbling in unheated air at the end of the cycle to reduce wrinkling. Set the Wrinkle Prevent switch **On** to activate this feature (select models). Some models automatically provide 30 minutes of Wrinkle Prevent at the end of the Wrinkle Control cycle only.

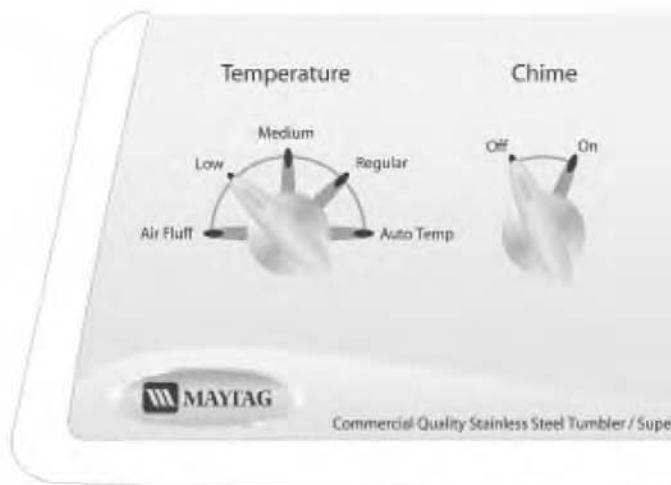

STEP 3

Select Dryness Setting

To select the dryness level, turn the **Dryness Settings** knob to the desired setting.

Most loads will use the Normal dry setting. Loads of larger or bulkier size may require the More dry setting to completely dry the load.

The Less dry setting is best suited for lightweight fabrics or for leaving some moisture in the load at the end of the cycle. Damp dry is designed to partially dry items. Use for items that lay flat or hang to dry.

STEP 4

Select Cycle

To select a cycle, rotate the **cycle selector** dial to the desired cycle. The indicator light by the cycle name will illuminate.

The dryer cycles are Sensor Dry cycles. Sensor Dry automatically senses the moisture in the load and shuts the dryer off when the selected dryness level (Damp dry to More dry) is reached.



Cycles and options may vary by model.

Refresh (select models)

The Refresh cycle is designed to release wrinkles from items that are clean and dry but only slightly wrinkled, such as from a crowded closet or suitcase or from sitting in the dryer too long after the cycle has ended. Refresh can be used with any temperature selection.

Note: If the dryer detects moisture in the load when Refresh is selected, the dryer will automatically switch to the Wrinkle Control cycle which may extend the cycle time.

Regular

The Regular cycle is designed to dry loads such as towels and underwear.

Jeans (select models)

The Jeans cycle is designed to reduce wrinkling and tangling in loads of jeans.

Wrinkle Control

The Wrinkle Control cycle is designed to dry wrinkle-free cottons, synthetic fabrics, knits and permanent press fabrics automatically.

Select models will automatically advance into Wrinkle Prevent which provides an extra 30 minutes of unheated tumble action at the end of the cycle.

On dryer models with optional Wrinkle Prevent, the additional 95 minutes of unheated tumbling can be canceled by turning the switch to **Off** or by opening the door.

Delicates

The Delicates cycle is designed to dry heat-sensitive items at the low drying temperature.

Time Dry/Air Fluff

The Time Dry cycle can be used to regulate the drying time. Use with any temperature setting. For timed drying, turn the cycle selector dial to the number of minutes desired. An indicator light will illuminate by the setting.

Note: Using the Air Fluff temperature setting will require a longer drying time.

STEP 5

Start the Dryer

After setting the cycle and desired options, press the **cycle selector** dial to start the dryer. To pause the cycle, press **cycle selector** dial again or by opening the door. To restart the cycle, press **cycle selector** dial and cycle will resume from the point of interruption.

Power Off

Turn the **cycle selector** dial to **Power Off** to cancel the cycle and stop the dryer.



Using the Controls - Electronic Controls

Features

Cycle Status Lights

The Drying light will illuminate and remain lit until the dryer enters the cool down portion of the cycle. When the dryer is in the cool down portion of the cycle, the Cool Down light will illuminate.

The Wrinkle Prevent and Complete light will illuminate when the dryer has moved into the Wrinkle Prevent portion of the cycle. On some models, Wrinkle Prevent will automatically follow the Wrinkle Control cycle.

The Complete light will illuminate when the cycle is complete. The light will remain illuminated until the dryer door is opened.

If the dryer is paused during a cycle, the Pause light will illuminate until the cycle is resumed or the dryer is turned off.

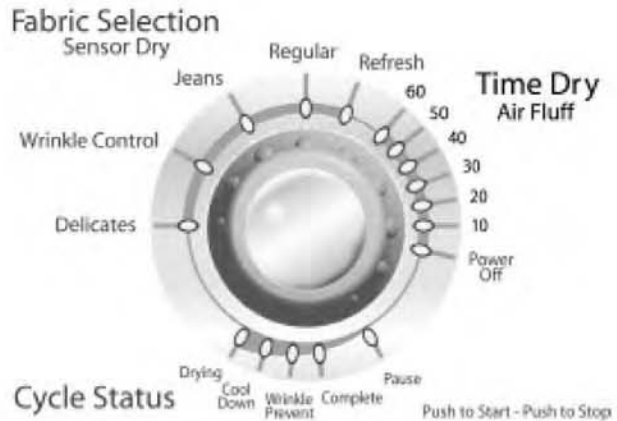



Operating Tips

Clean the Lint Filter

- After each load.
- To shorten drying time.
- To operate more energy efficiently.

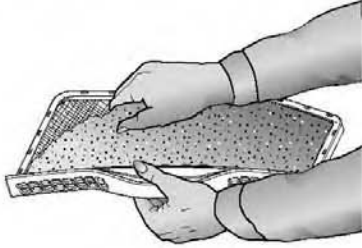

Note: Do not operate the dryer without the lint filter in place.

Load the Dryer Properly

- Place only one washload in the dryer at a time.
- Mixed loads of heavy and lightweight clothes will dry differently. Lightweight clothes will dry, while heavy clothes may be damp.
- Add one or more similar items to the dryer when only one or two articles need drying. This improves the tumbling action and drying efficiency.
- Overloading restricts tumbling action, resulting in uneven drying as well as excessive wrinkling of some fabrics.
- When drying large, bulky items such as a blanket or comforter, it may be necessary to reposition the load during the cycle to ensure even drying.

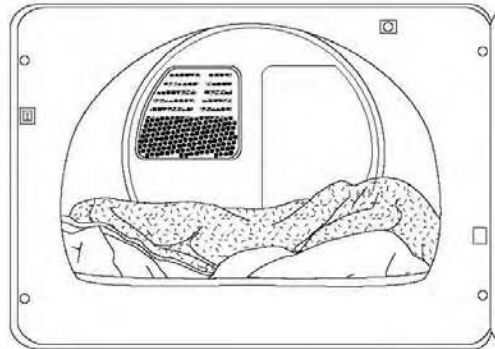

Accessories

Optional Drying Rack

Select dryer models are equipped with a drying rack. The drying rack is useful for drying items that require no tumble drying, such as tennis shoes, sweaters, stuffed toys or other delicate items.

Note: The Drying Rack, part no. 504105, is available when not included with your dryer. See your dealer or call 1-877-232-6771 to order.

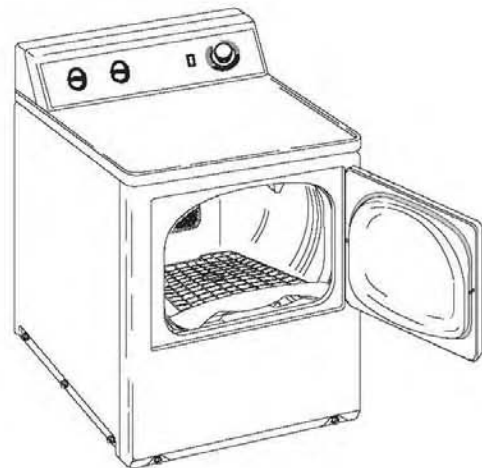



Care & Cleaning

Control Panel

Clean with a soft, damp cloth. Do not use abrasive substances.

Tumbler

Remove any stains such as crayon, ink pen or fabric dye from new items (such as towels or jeans) with an all-purpose cleaner. Then tumble old towels or rags to remove any excess stain or cleaning substance. Once these steps are done, stains may still be visible, but should not transfer to subsequent loads.

Cabinet

Wipe off any marks with soap and water. Use an appliance wax once a year if desired.

Dryer Exhaust System

Inspect and clean once a year to maintain optimum performance. The outside exhaust hood should be cleaned more frequently to ensure proper operation. (Refer to the Installation Instructions for more information.)

Special Laundry Tips

Please follow the care label or manufacturer's instructions for drying special items. If care label instructions are not available, use the following information as a guide.

ITEM	LAUNDERING TIPS
Bedspreads and Comforters	<ul style="list-style-type: none"> Follow the care label instructions or dry on the Regular cycle. Be sure the item is thoroughly dry before using or storing. May require repositioning to ensure even drying.
Blankets	<ul style="list-style-type: none"> Dry only one blanket at a time for best tumbling action. Be sure the item is thoroughly dry before using or storing.
Curtains and Draperies	<ul style="list-style-type: none"> Select the Wrinkle Control cycle to help minimize wrinkling. Dry in small loads for best results and remove as soon as possible.
Cloth Diapers	<ul style="list-style-type: none"> Select the Regular cycle for soft, fluffy diapers.
Down-Filled Items (<i>jackets, sleeping bags, comforters, etc.</i>)	<ul style="list-style-type: none"> Select the Regular cycle and a Delicate temperature setting. Place a clean pair of sneakers in the dryer with the item to fluff the down comforters, etc. Adding a couple of dry towels shortens dry time and absorbs moisture.
Foam Rubber (<i>rug backs, stuffed toys, certain shoulder pads, etc.</i>)	<ul style="list-style-type: none"> Do not dry on a heat setting. Select the Time Dry/Air Fluff (no-heat) cycle. ⚠ WARNING - Drying a rubber item with heat may damage it or be a fire hazard.
Pillows	<ul style="list-style-type: none"> Do not dryer-dry kapok or foam pillows. Select the Regular cycle. Add a couple of dry towels and a pair of clean sneakers to help the tumbling action and to fluff the item.
Plastics (<i>shower curtains, outdoor furniture covers, etc.</i>)	<ul style="list-style-type: none"> Select the Time Dry/Air Fluff cycle on a Delicate or Air Fluff temperature depending on the care label instructions.

IMPORTANT: Avoid Dryer Drying . . .

- Fiberglass Items (curtains, draperies, etc.).
- Woolens, unless recommended on the label.
- Vegetable or cooking oil soaked items (see fire hazard warning, page 1).



Reversing the Door

Reversing the Door

Follow these steps to reverse the door:

1. Remove four hinge-attaching screws.
2. Remove all nine screws from door and hinges.
3. Pull bottom of door liner out (A), then pull down (B), removing door liner from door panel.
4. Rotate door panel 180° as shown.

5. Remove door strike from door liner and reinstall on opposite side.
6. Insert liner under flange on bottom of door (A), then push top of door liner into place (B).
7. Reinstall nine screws removed in Step 2.
8. Using screwdriver, remove two door plugs and reinstall on opposite side of door opening.
9. Reinstall four hinge attaching screws removed in Step 1.

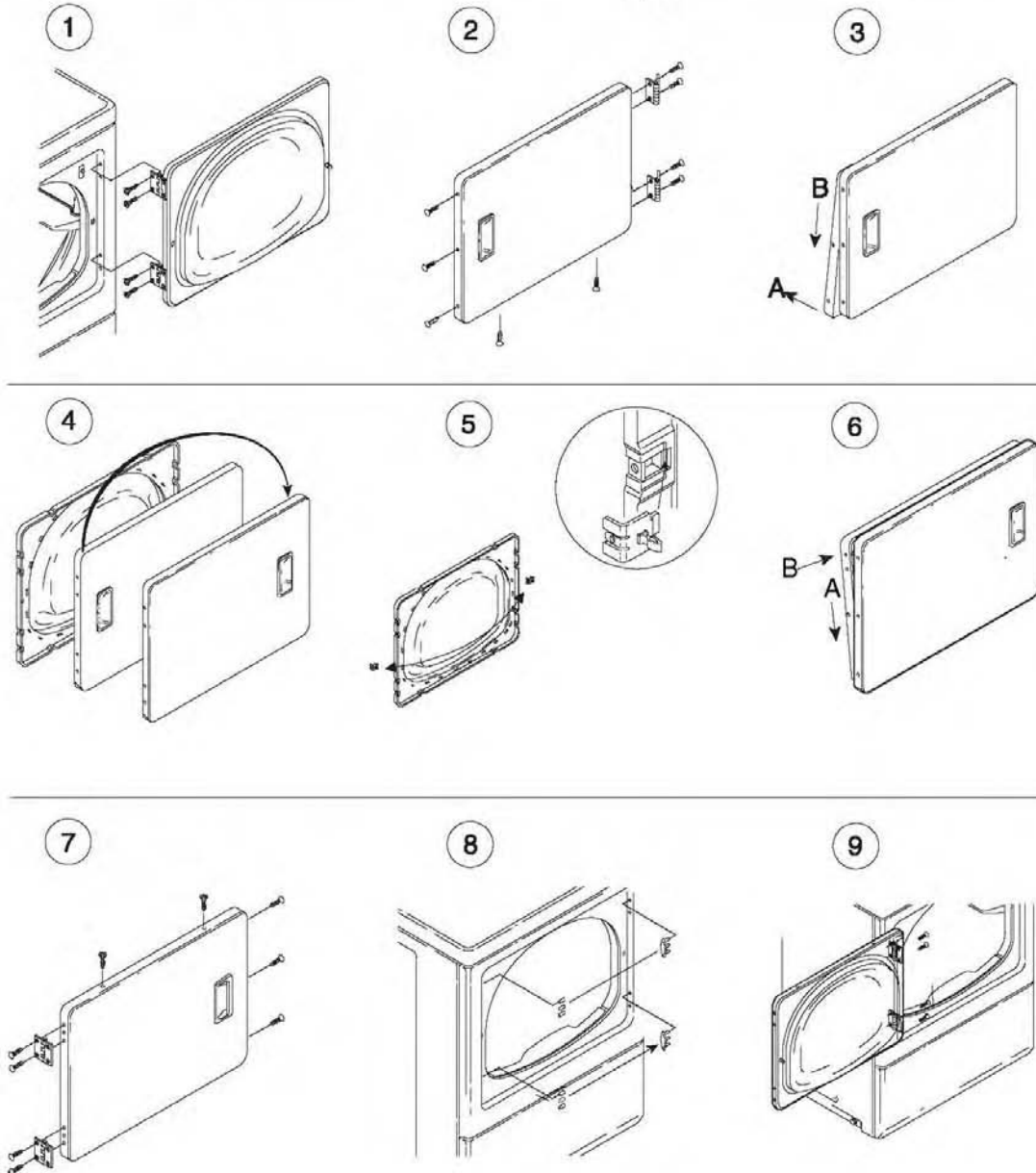



Dryer Exhaust Tips

⚠ WARNING

Plastic or nonmetal flexible duct presents a potential fire hazard.

Do

Read the Installation Instructions and the Use and Care Guide.

DON'T

Let a poor exhaust system cause slow drying.

Do

Let your dryer exhaust the air easily.

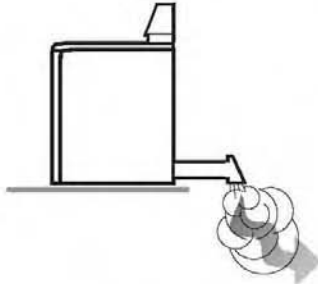

DON'T

Restrict your dryer with a poor exhaust system.

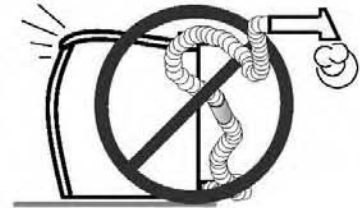

Do

Use 4 inch diameter rigid metal duct. Tape all joints, including at the dryer. Never use lint-trapping screws.

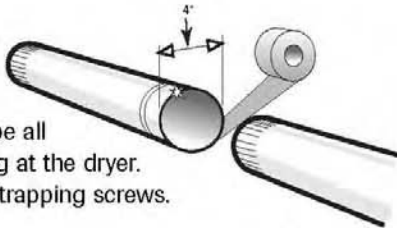

DON'T

Use plastic, thin foil, or non-metal flexible duct.



Do

Keep duct runs as straight as possible.

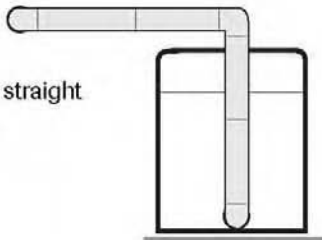

DON'T

Use longer than necessary duct runs with many elbows.

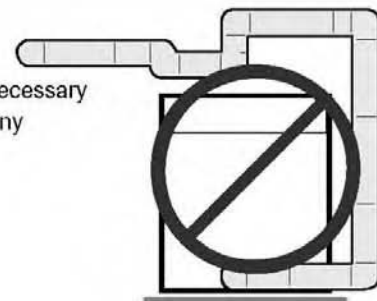

Do

Clean all old ducts before installing your new dryer. Be sure vent flap opens and closes freely. Inspect and clean the exhaust system annually.

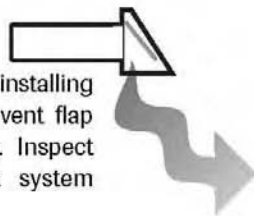

DON'T

Allow crushed or clogged ducts and vent.

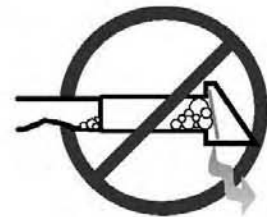



Troubleshooting

Doesn't Run	<ul style="list-style-type: none"> • Be sure the door is shut. • Check to make sure the electrical cord is plugged in. • Check fuse or reset circuit breaker. • Push the control dial in again if the door was opened during the cycle.
Doesn't Heat	<ul style="list-style-type: none"> • Check fuse or reset circuit breaker. • Select a heat setting, not air fluff. • Check that the gas supply is on for gas dryers. • Clean the lint filter and exhaust duct. • Dryer timer may have moved into the cool-down portion of the cycle.
Doesn't Dry Properly	<p>Check all of the above, plus . . .</p> <ul style="list-style-type: none"> • Check the exhaust hood outside the house, make sure it opens and closes freely. • Check exhaust system for lint buildup. Ducting should be inspected and cleaned annually. • Use rigid 4" metal exhaust duct. • Do not overload. 1 wash load = 1 dryer load. • Sort heavy items from lightweight items. • Large, bulky items like blankets or comforters may require repositioning to ensure even drying. • Check the washer to be sure it is draining properly to extract water from the load. • Clothes load is too small to tumble properly. Add a few towels.
Is Noisy	<ul style="list-style-type: none"> • Check the load for objects such as coins, nails, etc. Remove promptly from dryer. • It is normal to hear the dryer gas valve or heating element cycle on and off during the drying cycle. • The dryer should be level and installed on a solid floor. • A clicking noise may be the timer advancing. • It is normal for the dryer to hum due to the high velocity of air moving through the dryer drum and exhaust system.
Control Knob Advances Slowly (select models)	<ul style="list-style-type: none"> • This is normal operation for an Auto Dry or Sensor cycle, especially at the beginning of cycle. Once the load begins to dry, the control knob will start to advance. The rate of advancement will be slow at the beginning of the cycle because there is more moisture in the load. As the load becomes more dry, the control knob will advance more quickly.
Dries Unevenly	<ul style="list-style-type: none"> • Seams, pockets and other similar heavy areas may not be completely dry when the rest of the load has reached the selected dryness level. This is normal. Select the More Dry setting if desired. • If one heavy item is dried with a lightweight load, such as one towel with sheets, it is possible that the heavy item will not be completely dry when the rest of the load has reached the selected dryness level. Sort heavy items from lightweight items for best drying results.
Has an Odor	<ul style="list-style-type: none"> • Household odors such as from painting, varnishing, strong cleaners, etc. may enter the dryer with the surrounding room air. This is normal as the dryer draws the air from the room, heats it, pulls it through the tumbler and exhausts it to the outside. When these odors are present in the air, ventilate the room completely before using the dryer.

For further assistance contact Maytag ServicesSM, Customer Assistance: U.S.A. 1-800-688-9900 or Canada 1-800-688-2002. U.S.A. Customers using TTY for deaf, hearing impaired or speech impaired, call 1-800-688-2080.



Notes

Amana[®]

Dryer

ND-1

Use & Care Guide



Important Safety Instructions 1-2



Using the Controls

Auto Dry Models 3-4

Electronic Controls 5-7



Operating Tips 8



Accessories 8



Care & Cleaning 9



Reversing the Door 10



Dryer Exhaust Tips 11



Troubleshooting 12





Important Safety Instructions

Installer: Please leave this guide with this appliance.

Consumer: Please read and keep this guide for reference. Keep sales receipt and/or canceled check as proof of purchase.

Model Number _____

Serial Number _____

Date of Purchase _____

If you have questions, call:

Customer Assistance
1-800-688-9900 U.S.A.
1-866-688-2002 Canada
(Mon.-Fri. 8 a.m.-8 p.m. Eastern Time)
Internet: <http://www.amana.com>

U.S.A. Customers using TTY for deaf, hearing impaired or speech impaired, call 1-800-688-2080.

In our continuing effort to improve the quality and performance of our appliances, it may be necessary to make changes to the appliance without revising this guide.

For service information, see page 13.

What You Need to Know About Safety Instructions

Warning and Important Safety Instructions appearing in this guide are not meant to cover all possible conditions and situations that may occur. Common sense, caution and care must be exercised when installing, maintaining or operating appliance.

Always contact the manufacturer about problems or conditions you do not understand.

Recognize Safety Symbols, Words, Labels

WARNING

WARNING – Hazards or unsafe practices which **COULD** result in severe personal injury or death.

CAUTION

CAUTION – Hazards or unsafe practices which **COULD** result in minor personal injury.

WARNING

For your safety, the information in this guide must be followed to minimize the risk of fire or explosion or to prevent property damage, personal injury or death.

- Do not store or use gasoline or other flammable vapors and liquids in the vicinity of this or any other appliance.

WHAT TO DO IF YOU SMELL GAS

- Do not try to light any appliance.
- Do not touch any electrical switch.
- Do not use any phone in your building.
- Clear the room, building or area of all occupants.
- Immediately call your gas supplier from a neighbor's phone. Follow the gas supplier's instructions.
- If you cannot reach your gas supplier, call the fire department.

Installation and service must be performed by a qualified installer, service agency or the gas supplier.

WARNING! FIRE HAZARD

Do not place into your dryer items that have been spotted or soaked with vegetable oil or cooking oil. Even after being washed, these items may contain significant amounts of these oils. The remaining oil can ignite spontaneously. The potential for spontaneous ignition increases when the items containing vegetable oil or cooking oil are exposed to heat. Heat sources, such as your clothes dryer, can warm these items, allowing an oxidation reaction in the oil to occur. Oxidation creates heat. If this heat cannot escape, the items can become hot enough to catch fire. Piling, stacking or storing these kinds of items may prevent heat from escaping and can create a fire hazard.

All washed and unwashed fabrics that contain vegetable oil or cooking oil can be dangerous. Washing these items in hot water with extra detergent will reduce, but will not eliminate, the hazard. Always use the Cool Down cycle for these items to reduce the items' temperature. Never remove these items from the clothes dryer hot or interrupt the drying cycle until the items have run through the Cool Down cycle. Never pile or stack these items when they are hot.



Important Safety Instructions

⚠ WARNING

To reduce the risk of fire, explosion, electric shock, or personal injury when using your dryer, follow basic safety precautions, including the following:

1. Read all instructions before using the appliance.
2. To avoid the possibility of fire or explosion:
 - a. **Do not** dry items that have been previously cleaned in, washed in, soaked in, or spotted with gasoline, dry-cleaning solvents, other flammable or explosive substances as they give off vapors that could ignite or explode. Any material on which you have used a cleaning solvent, or which is saturated with flammable liquids or solids, should not be placed in the dryer, until all traces of these flammable liquids or solids and their fumes have been removed. There are many highly flammable items used in homes, such as: acetone, denatured alcohol, gasoline, kerosene, some liquid household cleaners, some spot removers, turpentine, waxes and wax removers.
 - b. Items containing foam rubber (may be labeled latex foam) or similarly textured rubber-like materials must not be dried on a heat setting. Foam rubber materials when heated, can under certain circumstances produce fire by spontaneous combustion.
3. **Do not** allow children or pets to play on, in, or in front of the appliance. Close supervision is necessary when the appliance is used near children and pets.
4. Before the appliance is removed from service or discarded, remove the door to the drying compartment.
5. **Do not** reach into the appliance if the drum is moving.
6. **Do not** install or store this appliance where it will be exposed to the weather.
7. **Do not** tamper with controls.
8. **Do not** repair or replace any part of the appliance or attempt any servicing unless specifically recommended in published user-repair instructions that you understand and have the skills to carry out.
9. **Do not** use fabric softeners or products to eliminate static unless recommended for dryer use

by the manufacturer of the fabric softener or product.

10. Clean the lint screen before or after each load.
11. Keep the area around the exhaust opening and surrounding areas free from lint accumulation, dust and dirt.
12. The interior of the dryer and exhaust duct should be cleaned periodically by qualified service personnel.
13. This appliance must be properly grounded. **Never** plug the appliance cord into a receptacle which is not grounded adequately and in accordance with local and national codes. See installation instructions for grounding this appliance.
14. **Do not** sit on top of the clothes dryer.

Important Safety Notice & Warning

The California Safe Drinking Water and Toxic Enforcement Act of 1986 (Proposition 65) requires the Governor of California to publish a list of substances known to the State of California to cause cancer or reproductive harm, and requires businesses to warn customers of potential exposures to such substances.

Users of this appliance are hereby warned that the burning of gas can result in low-level exposure to some of the listed substances, including benzene, formaldehyde, and soot, due primarily to the incomplete combustion of natural gas or liquid petroleum (LP) fuels. Exhaust ducts should be kept free of obstructions and properly exhausted dryers will minimize exposure.

⚠ WARNING

Gas leaks may occur in your system and result in a dangerous situation. Gas leaks may not be detected by smell alone. Gas suppliers recommend you purchase and install an UL approved gas detector. Install and use in accordance with the manufacturer's instructions.

Note: Because of continuing product improvements, Amana reserves the right to change specifications without notice. For complete details, see the Installation Instructions packed with your product before selecting cabinetry, making cutouts or beginning installation.

SAVE THESE INSTRUCTIONS



Using the Controls - Auto Dry Models

STEP 1

Select Temperature

In order to select the correct temperature, turn the Temperature control to one of four choices; Regular, Medium (select models), Delicate or Air Fluff.

DRYER TEMPS	LOAD TYPE
Regular	Sturdy cottons or labels marked Tumble Dry.
Medium (select models)	For wrinkle-free/permanent press synthetics and lightweight cottons labeled Tumble Dry Medium.
Delicate	For heat sensitive items labeled Tumble Dry Low or Tumble Dry Medium.
Air Fluff	Items which need freshening. Load tumbles with room temperature air.

STEP 2

Select Options

End of Cycle Signal

When the cycle is complete, a signal will sound. The signal can be canceled by turning the switch to **Off**.

Remove load immediately to reduce wrinkling.

Extended Tumble (select models)

Extended Tumble is provided to minimize wrinkles in the Auto Dry No Iron Fabrics cycle. This feature provides an extra 60 minutes of unheated tumble action at the end of the cycle. Clothes can be removed any time during this portion of the cycle.

The additional 60 minutes of unheated tumbling can be canceled by turning the switch to **Off**.

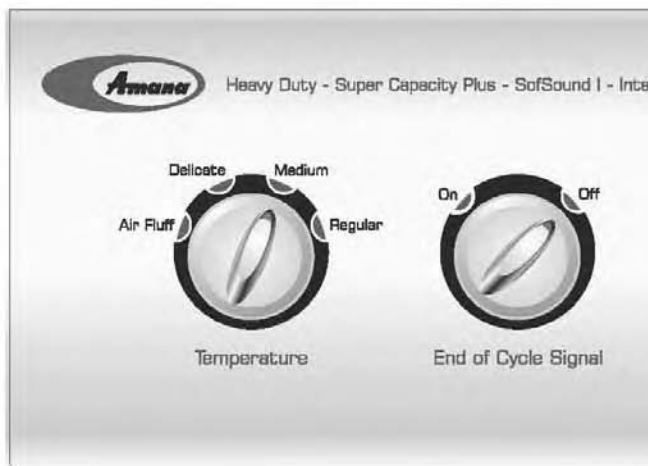

STEP 3

Select Cycle

To select a cycle, rotate the control dial to the desired setting. When using an Auto Dry Regular cycle, the control dial should point between More Dry and Less Dry for most loads.

Loads of larger or bulkier size may require the More Dry setting to completely dry the load. The Less Dry setting is best suited for lightweight fabrics or for leaving some moisture in the clothing at the end of the cycle.

Auto Dry Regular

The Auto Dry Regular cycle is designed to dry most cottons and linens. At the end of the cycle, the clothes are cooled to reduce wrinkling for approximately 10 minutes.

Auto Dry No Iron Fabrics

The Auto Dry No Iron Fabrics cycle is designed to dry wrinkle-free cottons, synthetic fabrics, double knits and permanent press fabrics automatically. At the end of the cycle, the clothes are cooled for approximately 10 minutes to reduce wrinkling. If the load is not removed from the dryer and **Extended Tumble** (select models) has been selected, the cycle will advance to Extended Tumble which provides additional unheated tumbling time. (See Step 2).

Cycles and options may vary by model.

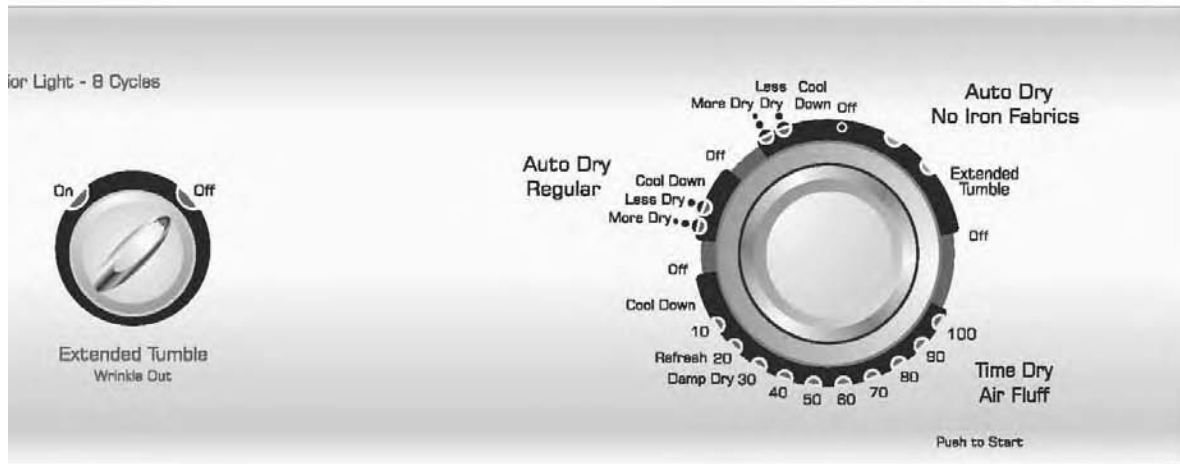

Time Dry/Air Fluff

This cycle can be used to regulate the drying time. Use with Air Fluff, Delicate, Medium (select models) or Regular temperature settings. For timed drying, turn the control dial until the pointer points to the proper time setting in the Time Dry/Air Fluff cycle.

Note: Using the Air Fluff temperature setting will require a longer drying time.

Damp Dry

Damp Dry is located on the Time Dry/Air Fluff section of the dial. It is designed to partially dry items and can be used with any temperature selection. Damp Dry will provide 20 minutes of tumbling time, followed by 10 minutes of cool-down tumbling.

Touch Up/Refresh

Touch Up/Refresh will release wrinkles from items that are clean and dry but only slightly wrinkled, such as from a crowded closet or suitcase, or from sitting in the dryer too long after the cycle has ended. Touch Up/Refresh provides 10 minutes of tumbling followed by 10 minutes of cool-down tumbling and can be used with any temperature selection.

STEP 4

Push the Control Dial in to Start

Push the control dial **in** to start the dryer. The dryer door must be closed for the dryer to start.

Note: The dial can be turned in either direction to select a cycle. Once started, the dial will not advance at a specific rate during the Auto Dry cycles. At first the dial may not advance at all. Toward the end of the cycle (when the load begins to dry), the dial will advance at a more regular rate and much more quickly. This is normal operation.



Using the Controls - Electronic Controls

STEP 1

Select Temperature

Auto Temp (preferred setting)

When **Auto Temp** is selected, the dryer will automatically select the most appropriate drying temperature based on the cycle and dryness settings selected.

If you prefer not to use Auto Temp, turn the **temperature selector** knob to the desired setting.

DRYER TEMPS	LOAD TYPE
Regular	Sturdy cottons or labels marked Tumble Dry.
Medium	For wrinkle-free/permanent press synthetics, lightweight cottons labeled Tumble Dry Medium.
Delicate	For heat sensitive items labeled Tumble Dry Low or Tumble Dry Medium.
Air Fluff	Items which need freshening. Load tumbles with room temperature air.

STEP 2

Select Options (if desired)

End of Cycle Chime

When the cycle is complete, an audible chime will sound. The chime will sound intermittently during Wrinkle Prevent. To turn the Chime off, turn the Chime selector switch to **Off**.

Wrinkle Prevent

Wrinkle Prevent provides approximately 95 minutes of intermittent tumbling in unheated air at the end of the cycle to reduce wrinkling. Set the Wrinkle Prevent knob **On** to activate this feature. The additional 95 minutes of unheated tumbling can be canceled by turning the switch to **Off**.

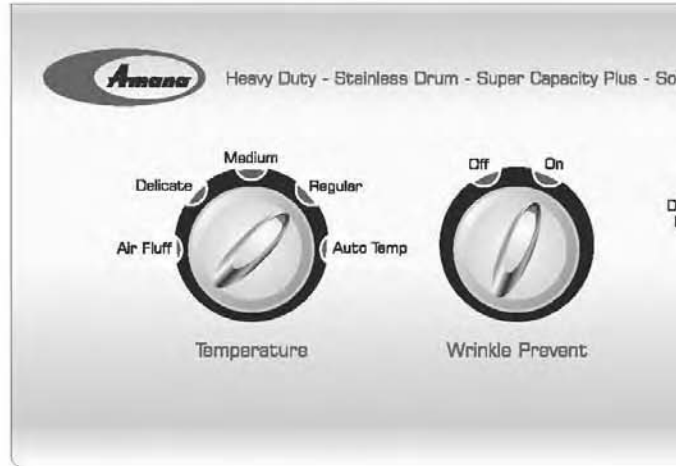

STEP 3

Select Dryness Setting

To select the dryness level, turn the **Dryness Setting** knob to the desired setting.

Most loads will use the Normal Dry setting. Loads of larger or bulkier size may require the More Dry setting to completely dry the load.

The Less Dry setting is best suited for lightweight fabrics or for leaving some moisture in the load at the end of the cycle. Damp Dry is designed to partially dry items. Use for items that lay flat or hang to dry.

STEP 4

Select Cycle

To select a cycle, rotate the **Cycle Selector** dial to the desired cycle. The indicator light by the cycle name will illuminate.

The dryer cycles are Sensor Dry cycles. Sensor Dry automatically senses the moisture in the load and shuts the dryer off when the selected dryness level (Damp Dry to More Dry) is reached.

Cycles and options may vary by model.

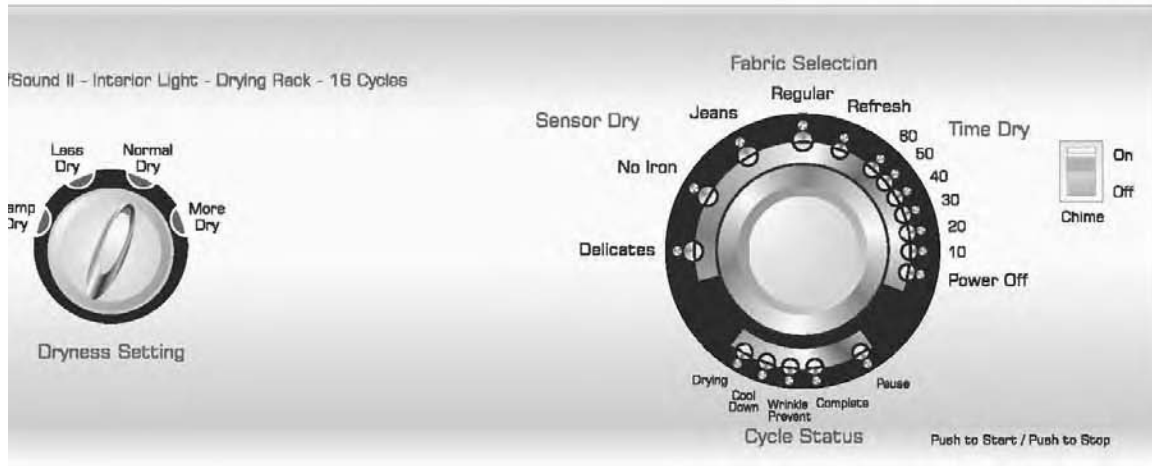

Refresh

The Refresh cycle is designed to release wrinkles from items that are clean and dry but only slightly wrinkled, such as from a crowded closet or suitcase or from sitting in the dryer too long after the cycle has ended. Refresh can be used with any temperature selection.

Regular

The Regular cycle is designed to dry loads such as towels and underwear.

Jeans

The Jeans cycle is designed to reduce wrinkling and tangling in loads of jeans.

No Iron

The No Iron cycle is designed to dry wrinkle-free cottons, synthetic fabrics, knits and permanent press fabrics automatically. The cycle minimizes wrinkling by providing a longer unheated cool-down period at the end of the cycle.

Delicates

The Delicates cycle is designed to dry heat-sensitive items at the Delicates drying temperature.

Time Dry

The Time Dry cycle can be used to regulate the drying time. Use with any temperature setting. For timed drying, turn the cycle selector dial to the number of minutes desired. An indicator light will illuminate by the setting.

Note: Using the Air Fluff temperature setting will require a longer drying time.

STEP 5

Start the Dryer

After setting the cycle and desired options, press the **cycle selector** dial to start the dryer. To pause the cycle, press **cycle selector** dial again. To restart the cycle, press **cycle selector** dial and the cycle will resume from the point of interruption.

Power Off

Turn the cycle selector dial to **Power Off** and press **cycle selector** dial to cancel the cycle and stop the dryer.



Using the Controls - Electronic Controls

Features

Cycle Status Lights

The Drying light will illuminate and remain lit until the dryer enters the cool down portion of the cycle. When the dryer is in the cool down portion of the cycle, the Cool Down light will illuminate.

The Wrinkle Prevent and Complete light will illuminate when the dryer has moved into the Wrinkle Prevent portion of the cycle. On some models, Wrinkle Prevent will automatically follow the Wrinkle Control cycle.

The Complete light will illuminate when the cycle is complete. The light will remain illuminated until the dryer door is opened.

If the dryer is paused during a cycle, the Pause light will illuminate until the cycle is resumed or the dryer is turned off.

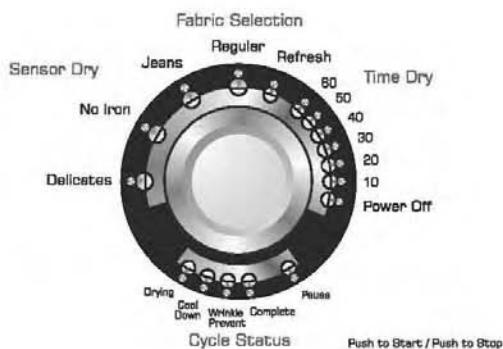



Operating Tips

Clean the Lint Filter

- After each load.
- To shorten drying time.
- To operate more energy efficiently.

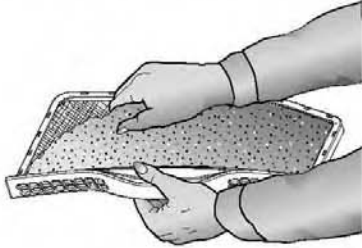

Note: Do not operate the dryer without the lint filter in place.

Load the Dryer Properly

- Place only one washload in the dryer at a time.
- Mixed loads of heavy and lightweight clothes will dry differently. Lightweight clothes will dry, while heavy clothes may be damp.
- Add one or more similar items to the dryer when only one or two articles need drying. This improves the tumbling action and drying efficiency.
- Overloading restricts tumbling action, resulting in uneven drying as well as excessive wrinkling of some fabrics.
- When drying large, bulky items such as a blanket or comforter, it may be necessary to reposition the load during the cycle to ensure even drying.

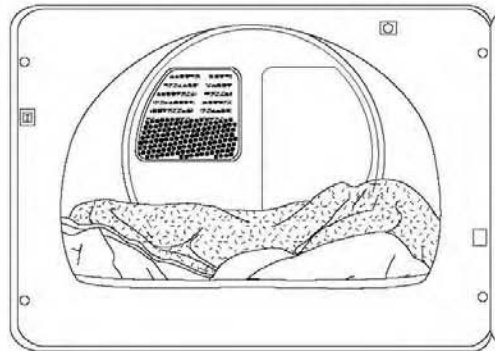

Accessories

Optional Drying Rack

Select dryer models are equipped with a drying rack. The drying rack is useful for drying items that require no tumble drying, such as tennis shoes, sweaters, stuffed toys or other delicate items.

Note: The Drying Rack, part no. 504105, is available when not included with your dryer. See your dealer or call 1-877-232-6771 to order.





Care & Cleaning

Control Panel

Clean with a soft, damp cloth. Do not use abrasive substances.

Tumbler

Remove any stains such as crayon, ink pen or fabric dye from new items (such as towels or jeans) with an all-purpose cleaner. Then tumble old towels or rags to remove any excess stain or cleaning substance. Once these steps are done, stains may still be visible, but should not transfer to subsequent loads.

Cabinet

Wipe off any marks with soap and water. Use an appliance wax once a year if desired.

Dryer Exhaust System

Inspect and clean once a year to maintain optimum performance. The outside exhaust hood should be cleaned more frequently to ensure proper operation. (Refer to the Installation Instructions for more information.)

Special Laundry Tips

Please follow the care label or manufacturer's instructions for drying special items. If care label instructions are not available, use the following information as a guide.

ITEM	LAUNDERING TIPS
Bedspreads and Comforters	<ul style="list-style-type: none"> Follow the care label instructions or dry on the Regular cycle. Be sure the item is thoroughly dry before using or storing. May require repositioning to ensure even drying.
Blankets	<ul style="list-style-type: none"> Dry only one blanket at a time for best tumbling action. Be sure the item is thoroughly dry before using or storing.
Curtains and Draperies	<ul style="list-style-type: none"> Select the No Iron cycle to help minimize wrinkling. Dry in small loads for best results and remove as soon as possible.
Cloth Diapers	<ul style="list-style-type: none"> Select the Regular cycle for soft, fluffy diapers.
Down-Filled Items (<i>jackets, sleeping bags, comforters, etc.</i>)	<ul style="list-style-type: none"> Select the Regular cycle and a Delicate temperature setting. Place a clean pair of sneakers in the dryer with the item to fluff the down comforters, etc. Adding a couple of dry towels shortens dry time and absorbs moisture.
Foam Rubber (<i>rug backs, stuffed toys, certain shoulder pads, etc.</i>)	<ul style="list-style-type: none"> Do not dry on a heat setting. Select the Time Dry/Air Fluff (no-heat) cycle. ⚠ WARNING - Drying a rubber item with heat may damage it or be a fire hazard.
Pillows	<ul style="list-style-type: none"> Do not dryer-dry kapok or foam pillows. Select the Regular cycle. Add a couple of dry towels and a pair of clean sneakers to help the tumbling action and to fluff the item.
Plastics (<i>shower curtains, outdoor furniture covers, etc.</i>)	<ul style="list-style-type: none"> Select the Time Dry cycle on a Delicate or Air Fluff temperature depending on the care label instructions.

IMPORTANT: Avoid Dryer Drying . . .

- Fiberglass Items (curtains, draperies, etc.).
- Woolens, unless recommended on the label.
- Vegetable or cooking oil soaked items (see fire hazard warning, page 1).



Reversing the Door

Reversing the Door

Follow these steps to reverse the door:

1. Remove four hinge-attaching screws.
2. Remove all nine screws from door and hinges.
3. Pull bottom of door liner out (A), then pull down (B), removing door liner from door panel.
4. Rotate door panel 180° as shown.
5. Remove door strike from door liner and reinstall on opposite side.
6. Insert liner under flange on bottom of door (A), then push top of door liner into place (B).
7. Reinstall nine screws removed in Step 2.
8. Using screwdriver, remove two door plugs and reinstall on opposite side of door opening.
9. Reinstall four hinge attaching screws removed in Step 1.

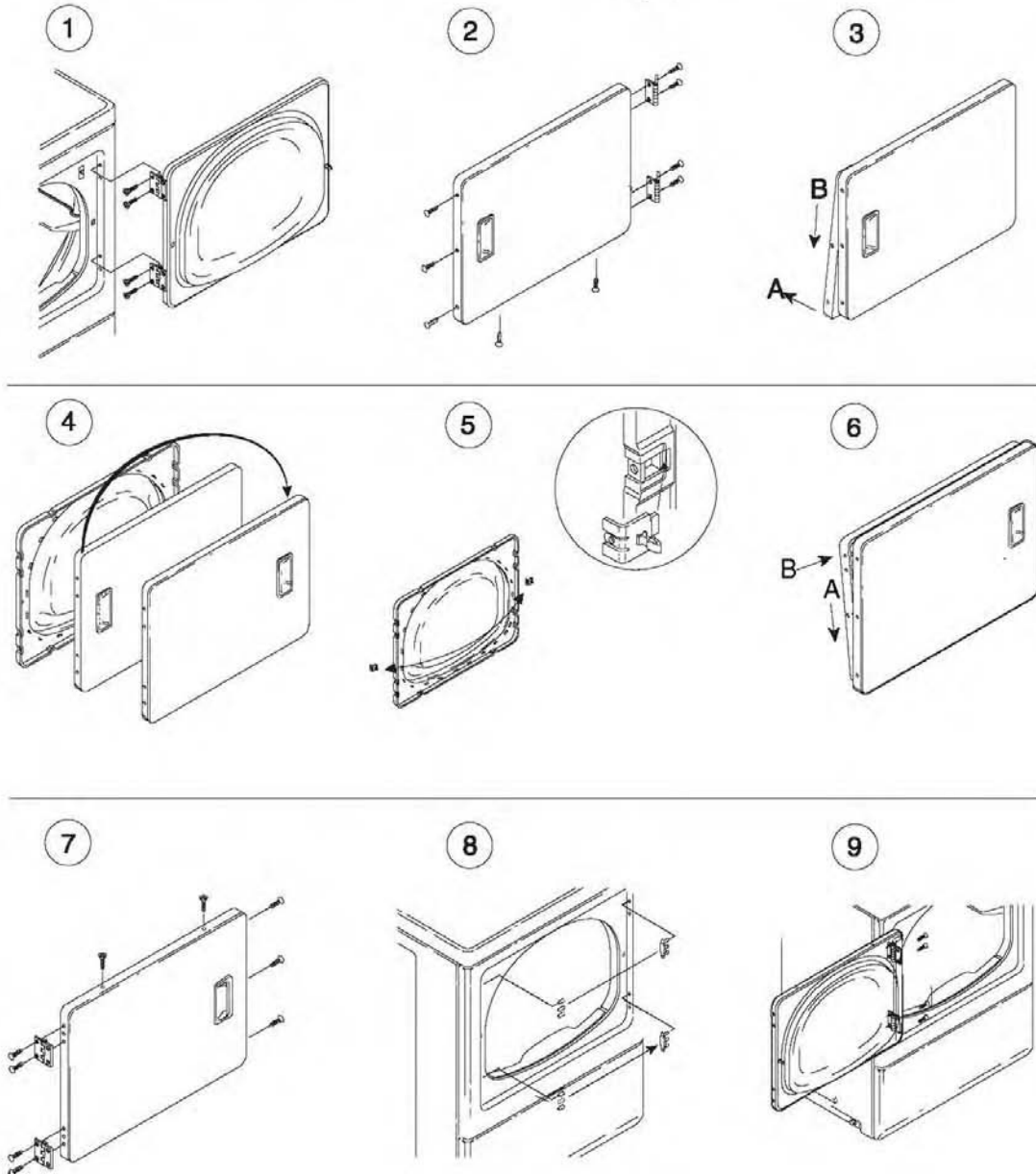



Dryer Exhaust Tips

⚠ WARNING

Plastic or nonmetal flexible duct presents a potential fire hazard.

Do

Read the Installation Instructions and the Use and Care Guide.

DON'T

Let a poor exhaust system cause slow drying.

Do

Let your dryer exhaust the air easily.

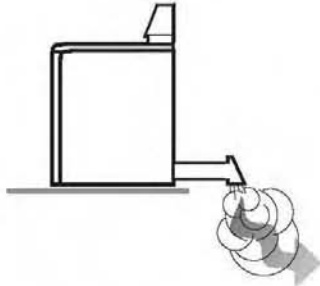

DON'T

Restrict your dryer with a poor exhaust system.

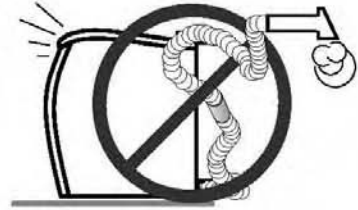

Do

Use 4 inch diameter rigid metal duct. Tape all joints, including at the dryer. Never use lint-trapping screws.

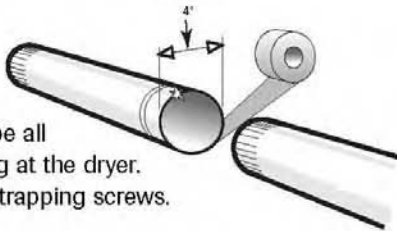

DON'T

Use plastic, thin foil, or non-metal flexible duct.



Do

Keep duct runs as straight as possible.

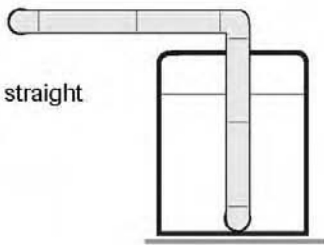

DON'T

Use longer than necessary duct runs with many elbows.

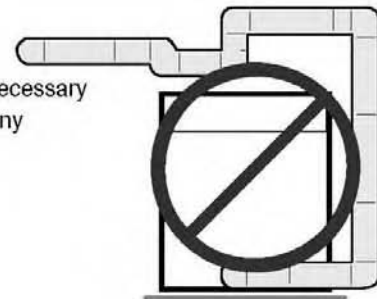

Do

Clean all old ducts before installing your new dryer. Be sure vent flap opens and closes freely. Inspect and clean the exhaust system annually.

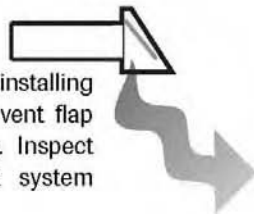

DON'T

Allow crushed or clogged ducts and vent.

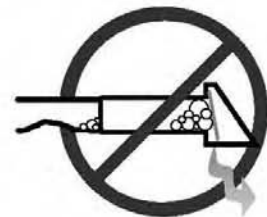

Troubleshooting

Doesn't Run	<ul style="list-style-type: none"> • Be sure the door is shut. • Check to make sure the electrical cord is plugged in. • Check fuse or reset circuit breaker. • Push the control dial in again if the door was opened during the cycle.
Doesn't Heat	<ul style="list-style-type: none"> • Check fuse or reset circuit breaker. • Select a heat setting, not air fluff. • Check that the gas supply is on for gas dryers. • Clean the lint filter and exhaust duct. • Dryer timer may have moved into the cool-down portion of the cycle.
Doesn't Dry Properly	<p>Check all of the above, plus . . .</p> <ul style="list-style-type: none"> • Check the exhaust hood outside the house, make sure it opens and closes freely. • Check exhaust system for lint buildup. Ducting should be inspected and cleaned annually. • Use rigid 4" metal exhaust duct. • Do not overload. 1 wash load = 1 dryer load. • Sort heavy items from lightweight items. • Large, bulky items like blankets or comforters may require repositioning to ensure even drying. • Check the washer to be sure it is draining properly to extract water from the load. • Clothes load is too small to tumble properly. Add a few towels.
Is Noisy	<ul style="list-style-type: none"> • Check the load for objects such as coins, nails, etc. Remove promptly from dryer. • It is normal to hear the dryer gas valve or heating element cycle on and off during the drying cycle. • The dryer should be level and installed on a solid floor. • A clicking noise may be the timer advancing. • It is normal for the dryer to hum due to the high velocity of air moving through the dryer drum and exhaust system.
Control Knob Advances Slowly (select models)	<ul style="list-style-type: none"> • This is normal operation for an Auto Dry or Sensor cycle, especially at the beginning of cycle. Once the load begins to dry, the control knob will start to advance. The rate of advancement will be slow at the beginning of the cycle because there is more moisture in the load. As the load becomes more dry, the control knob will advance more quickly.
Dries Unevenly	<ul style="list-style-type: none"> • Seams, pockets and other similar heavy areas may not be completely dry when the rest of the load has reached the selected dryness level. This is normal. Select the More Dry setting if desired. • If one heavy item is dried with a lightweight load, such as one towel with sheets, it is possible that the heavy item will not be completely dry when the rest of the load has reached the selected dryness level. Sort heavy items from lightweight items for best drying results.
Has an Odor	<ul style="list-style-type: none"> • Household odors such as from painting, varnishing, strong cleaners, etc. may enter the dryer with the surrounding room air. This is normal as the dryer draws the air from the room, heats it, pulls it through the tumbler and exhausts it to the outside. When these odors are present in the air, ventilate the room completely before using the dryer.

For further assistance contact Maytag ServicesSM, Customer Assistance: U.S.A. 1-800-688-9900 or Canada 1-800-688-2002. U.S.A. Customers using TTY for deaf, hearing impaired or speech impaired, call 1-800-688-2080.



Notes

Clothes **Dryer** Use & Care Guide

PDT-1



Table of Contents



Important Safety Instructions1-2



Using the Controls
5 Cycles Model3-4
6 Cycles Model5-6



Operating Tips 7



Accessories 7



Care & Cleaning 8



Reversing the Door9



Dryer Exhaust Tips10



Troubleshooting 11





Important Safety Instructions

Installer: Please leave this guide with this appliance.

Consumer: Please read and keep this guide for future reference. Keep sales receipt and/or canceled check as proof of purchase.

Model Number _____

Serial Number _____

Date of Purchase _____

If you have questions, call:

Customer Assistance
1-800-688-9900 U.S.A.
1-800-688-2002 Canada
(Mon.-Fri. 8 a.m.-8 p.m. Eastern Time)
Internet: <http://www.maytag.com>

U.S.A. Customers using TTY for deaf, hearing impaired or speech impaired, call 1-800-688-2080.

In our continuing effort to improve the quality and performance of our appliances, it may be necessary to make changes to the appliance without revising this guide.

For service information, see page 13.

What You Need to Know About Safety Instructions

Warning and Important Safety Instructions appearing in this guide are not meant to cover all possible conditions and situations that may occur. Common sense, caution and care must be exercised when installing, maintaining or operating appliance.

Always contact the manufacturer about problems or conditions you do not understand.

Recognize Safety Symbols, Words, Labels

WARNING

WARNING – Hazards or unsafe practices which **COULD** result in severe personal injury or death.

CAUTION

CAUTION – Hazards or unsafe practices which **COULD** result in minor personal injury.

WARNING

For your safety, the information in this guide must be followed to minimize the risk of fire or explosion or to prevent property damage, personal injury or death.

- Do not store or use gasoline or other flammable vapors and liquids in the vicinity of this or any other appliance.

WHAT TO DO IF YOU SMELL GAS

- Do not try to light any appliance.
- Do not touch any electrical switch.
- Do not use any phone in your building.
- Clear the room, building or area of all occupants.
- Immediately call your gas supplier from a neighbor's phone. Follow the gas supplier's instructions.
- If you cannot reach your gas supplier, call the fire department.

Installation and service must be performed by a qualified installer, service agency or the gas supplier.

WARNING! FIRE HAZARD

Do not place into your dryer items that have been spotted or soaked with vegetable oil or cooking oil. Even after being washed, these items may contain significant amounts of these oils. The remaining oil can ignite spontaneously. The potential for spontaneous ignition increases when the items containing vegetable oil or cooking oil are exposed to heat. Heat sources, such as your clothes dryer, can warm these items, allowing an oxidation reaction in the oil to occur. Oxidation creates heat. If this heat cannot escape, the items can become hot enough to catch fire. Piling, stacking or storing these kinds of items may prevent heat from escaping and can create a fire hazard.

All washed and unwashed fabrics that contain vegetable oil or cooking oil can be dangerous. Washing these items in hot water with extra detergent will reduce, but will not eliminate, the hazard. Always use the Cool Down cycle for these items to reduce the items' temperature. Never remove these items from the clothes dryer hot or interrupt the drying cycle until the items have run through the Cool Down cycle. Never pile or stack these items when they are hot.



Important Safety Instructions

⚠ WARNING

To reduce the risk of fire, explosion, electric shock, or personal injury when using your dryer, follow basic safety precautions, including the following:

1. Read all instructions before using the appliance.
2. To avoid the possibility of fire or explosion:
 - a. **Do not** dry items that have been previously cleaned in, washed in, soaked in, or spotted with gasoline, dry-cleaning solvents, other flammable or explosive substances as they give off vapors that could ignite or explode. Any material on which you have used a cleaning solvent, or which is saturated with flammable liquids or solids, should not be placed in the dryer, until all traces of these flammable liquids or solids and their fumes have been removed. There are many highly flammable items used in homes, such as: acetone, denatured alcohol, gasoline, kerosene, some liquid household cleaners, some spot removers, turpentine, waxes and wax removers.
 - b. Items containing foam rubber (may be labeled latex foam) or similarly textured rubber-like materials must not be dried on a heat setting. Foam rubber materials when heated, can under certain circumstances produce fire by spontaneous combustion.
3. **Do not** allow children or pets to play on, in, or in front of the appliance. Close supervision is necessary when the appliance is used near children and pets.
4. Before the appliance is removed from service or discarded, remove the door to the drying compartment.
5. **Do not** reach into the appliance if the drum is moving.
6. **Do not** install or store this appliance where it will be exposed to the weather.
7. **Do not** tamper with controls.
8. **Do not** repair or replace any part of the appliance or attempt any servicing unless specifically recommended in published user-repair instructions that you understand and have the skills to carry out.
9. **Do not** use fabric softeners or products to eliminate static unless recommended for dryer use

- by the manufacturer of the fabric softener or product.
10. Clean the lint screen before or after each load.
 11. Keep the area around the exhaust opening and surrounding areas free from lint accumulation, dust and dirt.
 12. The interior of the dryer and exhaust duct should be cleaned periodically by qualified service personnel.
 13. This appliance must be properly grounded. **Never** plug the appliance cord into a receptacle which is not grounded adequately and in accordance with local and national codes. See installation instructions for grounding this appliance.
 14. **Do not** sit on top of the clothes dryer.

Important Safety Notice & Warning

The California Safe Drinking Water and Toxic Enforcement Act of 1986 (Proposition 65) requires the Governor of California to publish a list of substances known to the State of California to cause cancer or reproductive harm, and requires businesses to warn customers of potential exposures to such substances.

Users of this appliance are hereby warned that the burning of gas can result in low-level exposure to some of the listed substances, including benzene, formaldehyde, and soot, due primarily to the incomplete combustion of natural gas or liquid petroleum (LP) fuels. Exhaust ducts should be kept free of obstructions and properly exhausted dryers will minimize exposure.

⚠ WARNING

Gas leaks may occur in your system and result in a dangerous situation. Gas leaks may not be detected by smell alone. Gas suppliers recommend you purchase and install an UL approved gas detector. Install and use in accordance with the manufacturer's instructions.

Note: Because of continuing product improvements, Maytag reserves the right to change specifications without notice. For complete details, see the Installation Instructions packed with your product before selecting cabinetry, making cutouts or beginning installation.

SAVE THESE INSTRUCTIONS



Using the Controls - 5 Cycles Model

Performa



Temperature

Heavy Duty / Oversize Capacity Plus / 5 Cycles

STEP 1

Select Temperature

To select the correct temperature, turn the temperature control to **Regular** or **Delicate**.

DRYER TEMPS	LOAD TYPE
Regular	Sturdy cottons or labels marked Tumble Dry.
Delicate	For heat sensitive items labeled Tumble Dry Low or Tumble Dry Medium.

STEP 2

Select Cycle

To select a cycle, rotate the control dial to the desired setting. When using an Auto Dry cycle, the control dial should point between More Dry and Less Dry for most loads.

Loads of larger or bulkier size may require the More Dry setting to completely dry the load. The Less Dry setting is best suited for lightweight fabrics or for leaving some moisture in the clothing at the end of the cycle.

Auto Dry Regular

The Auto Dry Regular cycle is designed to dry most cottons and linens. At the end of the cycle, the clothes are cooled for approximately 10 minutes to reduce wrinkling.

Cycles and options may vary by model.

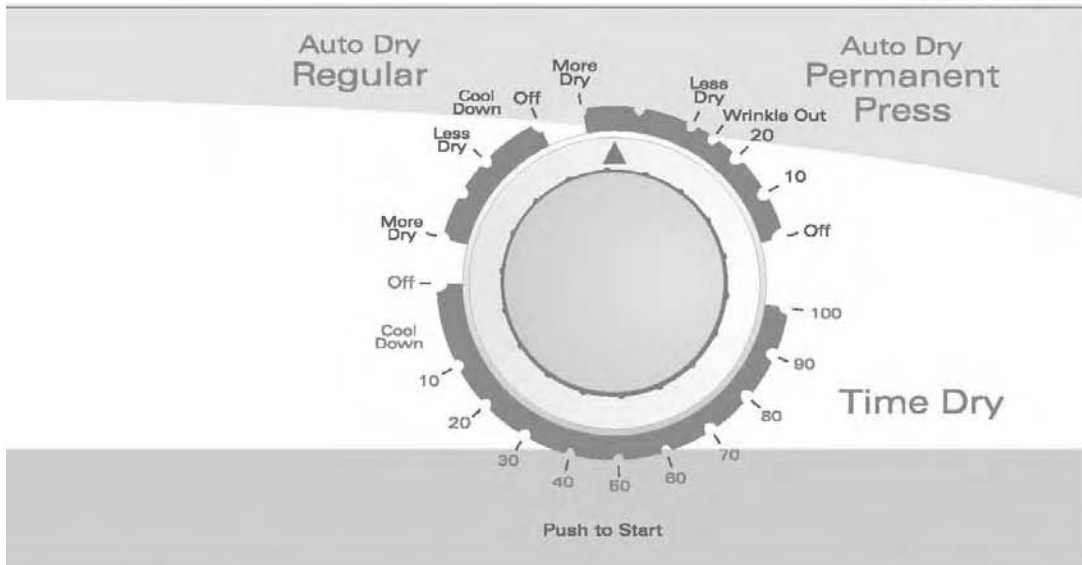

Auto Dry Permanent Press

The Auto Dry Permanent Press cycle is designed to dry wrinkle-free cottons, synthetic fabrics, double knits and permanent press fabrics automatically.

Wrinkle Out is provided to minimize wrinkles in the Auto Dry Permanent Press cycle. This feature provides an extra 30 minutes of unheated tumble action at the end of the cycle. Clothes can be removed any time during this portion of the cycle.

Time Dry

This cycle can be used to regulate the drying time. Use with Delicate or Regular temperature settings. For timed drying, turn the control dial until the pointer points to the proper time setting in the Time Dry cycle.

STEP 3

Push the Control Dial in to Start

Push the control dial **in** to start the dryer. The dryer door must be closed for the dryer to start.

Note: The dial can be turned in either direction to select a cycle. Once started, the dial will not advance at a specific rate during the Auto Dry cycles. At first the dial may not advance at all. Toward the end of the cycle (when the load begins to dry), the dial will advance at a more regular rate and much more quickly. This is normal operation.



Using the Controls - 6 Cycles Model

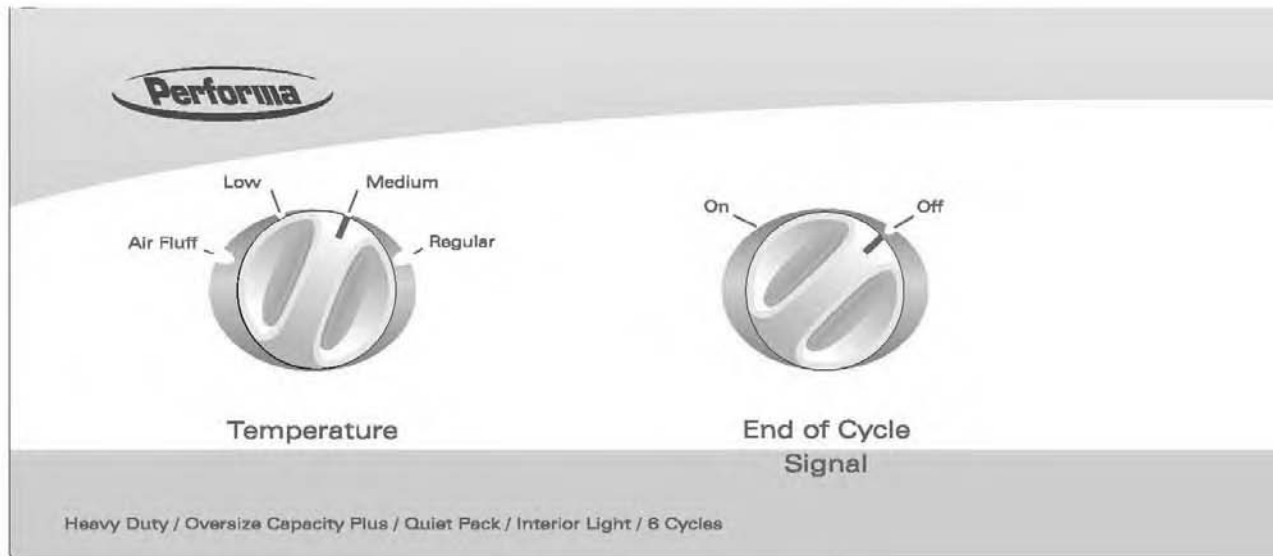

STEP 1

Select Temperature

To select the correct temperature, turn the temperature control to one of four choices: **Regular**, **Medium**, **Low** or **Air Fluff**.

DRYER TEMPS	LOAD TYPE
Regular	Sturdy cottons or labels marked Tumble Dry.
Medium	For wrinkle-free/permanent press synthetics, lightweight cottons or items labeled Tumble Dry Medium.
Low	For heat sensitive items labeled Tumble Dry Low or Tumble Dry Medium.
Air Fluff	Items which need freshening. Load tumbles with room temperature air. Use the Time Dry/Air Fluff cycle.

STEP 2

Select End of Cycle Signal

When the cycle is complete, a signal will sound. The signal can be canceled by turning the switch to **Off**.

Remove load immediately to reduce wrinkling.

STEP 3

Select Cycle

To select a cycle, rotate the control dial to the desired setting. When using an Auto Dry cycle, the control dial should point between More Dry and Less Dry for most loads.

Loads of larger or bulkier size may require the More Dry setting to completely dry the load. The Less Dry setting is best suited for lightweight fabrics or for leaving some moisture in the clothing at the end of the cycle.

Auto Dry Regular

The Auto Dry Regular cycle is designed to dry most cottons and linens. At the end of the cycle, the clothes are cooled for approximately 10 minutes to reduce wrinkling.

Auto Dry Permanent Press

The Auto Dry Permanent Press cycle is designed to dry wrinkle-free cottons, synthetic fabrics, double knits and permanent press fabrics automatically. At the end of the cycle, the clothes are cooled for approximately 10 minutes to reduce wrinkling.

Cycles and options may vary by model.

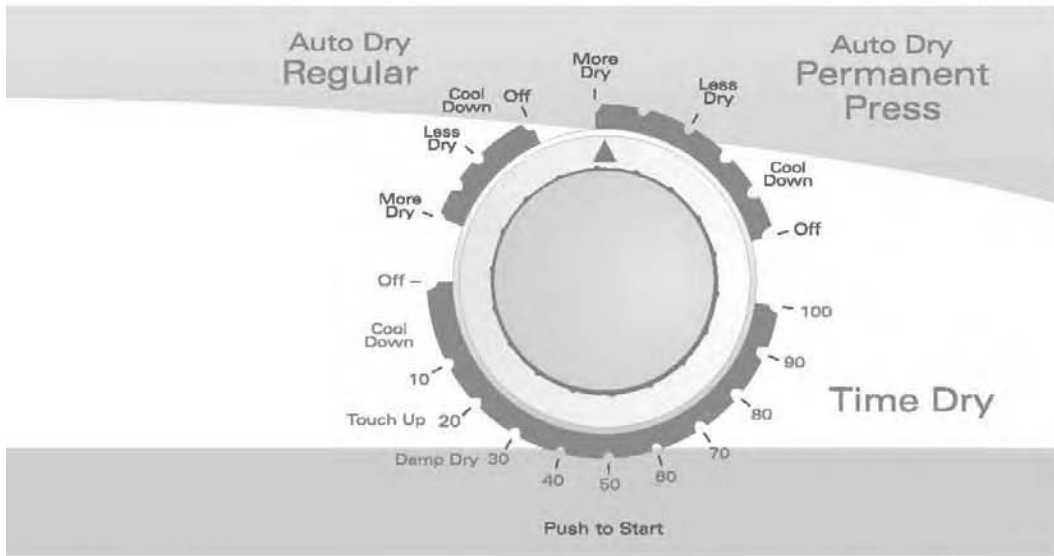

Time Dry

This cycle can be used to regulate the drying time. Use with Air Fluff, Low, Medium (select models) or Regular temperature settings. For timed drying, turn the control dial until the pointer points to the proper time setting in the Time Dry cycle.

Note: Using the Air Fluff temperature setting will require a longer drying time.

Damp Dry

Damp Dry is located on the Time Dry section of the dial. It is designed to partially dry items and can be used with any temperature selection. Damp Dry will provide 20 minutes of tumbling time, followed by 10 minutes of cool-down tumbling.

Touch Up

Touch Up will release wrinkles from items that are clean and dry but only slightly wrinkled, such as from a crowded closet or suitcase, or from sitting in the dryer too long after the cycle has ended. Touch Up provides 10 minutes of tumbling followed by 10 minutes of cool-down tumbling and can be used with any temperature selection.

STEP 4

Push the Control Dial in to Start

Push the control dial **in** to start the dryer. The dryer door must be closed for the dryer to start.

Note: The dial can be turned in either direction to select a cycle. Once started, the dial will not advance at a specific rate during the Auto Dry cycles. At first the dial may not advance at all. Toward the end of the cycle (when the load begins to dry), the dial will advance at a more regular rate and much more quickly. This is normal operation.



Operating Tips

Clean the Lint Filter

- After each load.
- To shorten drying time.
- To operate more energy efficiently.

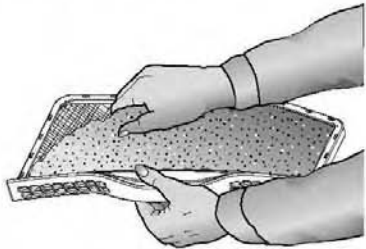

Note: Do not operate the dryer without the lint filter in place.

Load the Dryer Properly

- Place only one washload in the dryer at a time.
- Mixed loads of heavy and lightweight clothes will dry differently. Lightweight clothes will dry, while heavy clothes may be damp.
- Add one or more similar items to the dryer when only one or two articles need drying. This improves the tumbling action and drying efficiency.
- Overloading restricts tumbling action, resulting in uneven drying as well as excessive wrinkling of some fabrics.
- When drying large, bulky items such as a blanket or comforter, it may be necessary to reposition the load during the cycle to ensure even drying.

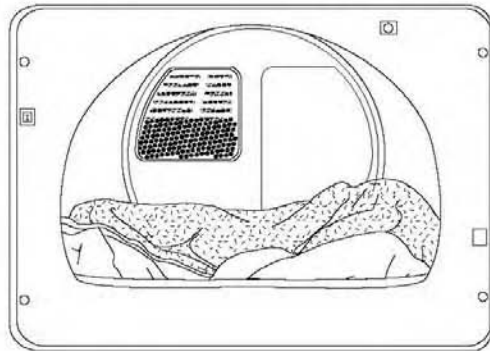

Accessories

Optional Drying Rack

Select dryer models are equipped with a drying rack. The drying rack is useful for drying items that require no tumble drying, such as tennis shoes, sweaters, stuffed toys or other delicate items.

Note: The Drying Rack, part no. 504105, is available when not included with your dryer. See your dealer or call 1-877-232-6771 to order.





Care & Cleaning

Control Panel

Clean with a soft, damp cloth. Do not use abrasive substances.

Tumbler

Remove any stains such as crayon, ink pen or fabric dye from new items (such as towels or jeans) with an all-purpose cleaner. Then tumble old towels or rags to remove any excess stain or cleaning substance. Once these steps are done, stains may still be visible, but should not transfer to subsequent loads.

Cabinet

Wipe off any marks with soap and water. Use an appliance wax once a year if desired.

Dryer Exhaust System

Inspect and clean once a year to maintain optimum performance. The outside exhaust hood should be cleaned more frequently to ensure proper operation. (Refer to the Installation Instructions for more information.)

Special Laundry Tips

Please follow the care label or manufacturer's instructions for drying special items. If care label instructions are not available, use the following information as a guide.

ITEM	LAUNDERING TIPS
Bedspreads and Comforters	<ul style="list-style-type: none"> Follow the care label instructions or dry on the Regular cycle. Be sure the item is thoroughly dry before using or storing. May require repositioning to ensure even drying.
Blankets	<ul style="list-style-type: none"> Dry only one blanket at a time for best tumbling action. Be sure the item is thoroughly dry before using or storing.
Curtains and Draperies	<ul style="list-style-type: none"> Select the Permanent Press cycle to help minimize wrinkling. Dry in small loads for best results and remove as soon as possible.
Cloth Diapers	<ul style="list-style-type: none"> Select the Regular cycle for soft, fluffy diapers.
Down-Filled Items (<i>jackets, sleeping bags, comforters, etc.</i>)	<ul style="list-style-type: none"> Select the Regular cycle and a Delicate temperature setting. Place a clean pair of sneakers in the dryer with the item to fluff the down comforters, etc. Adding a couple of dry towels shortens dry time and absorbs moisture.
Foam Rubber (<i>rug backs, stuffed toys, certain shoulder pads, etc.</i>)	<ul style="list-style-type: none"> Do not dry on a heat setting. Select the Time Dry (no-heat) cycle. WARNING – Drying a rubber item with heat may damage it or be a fire hazard.
Pillows	<ul style="list-style-type: none"> Do not dryer-dry kapok or foam pillows. Select the Regular cycle. Add a couple of dry towels and a pair of clean sneakers to help the tumbling action and to fluff the item.
Plastics (<i>shower curtains, outdoor furniture covers, etc.</i>)	<ul style="list-style-type: none"> Select the Time Dry cycle on a Delicate or Air Fluff temperature depending on the care label instructions.

IMPORTANT: Avoid Dryer Drying . . .

- Fiberglass Items (curtains, draperies, etc.).
- Woolens, unless recommended on the label.
- Vegetable or cooking oil soaked items (see fire hazard warning, page 1).



Reversing the Door

Reversing the Door

Follow these steps to reverse the door:

1. Remove four hinge-attaching screws.
2. Remove all nine screws from door and hinges.
3. Pull bottom of door liner out (A), then pull down (B), removing door liner from door panel.
4. Rotate door panel 180° as shown.
5. Remove door strike from door liner and reinstall on opposite side.
6. Insert liner under flange on bottom of door (A), then push top of door liner into place (B).
7. Reinstall nine screws removed in Step 2.
8. Using screwdriver, remove two door plugs and reinstall on opposite side of door opening.
9. Reinstall four hinge attaching screws removed in Step 1.

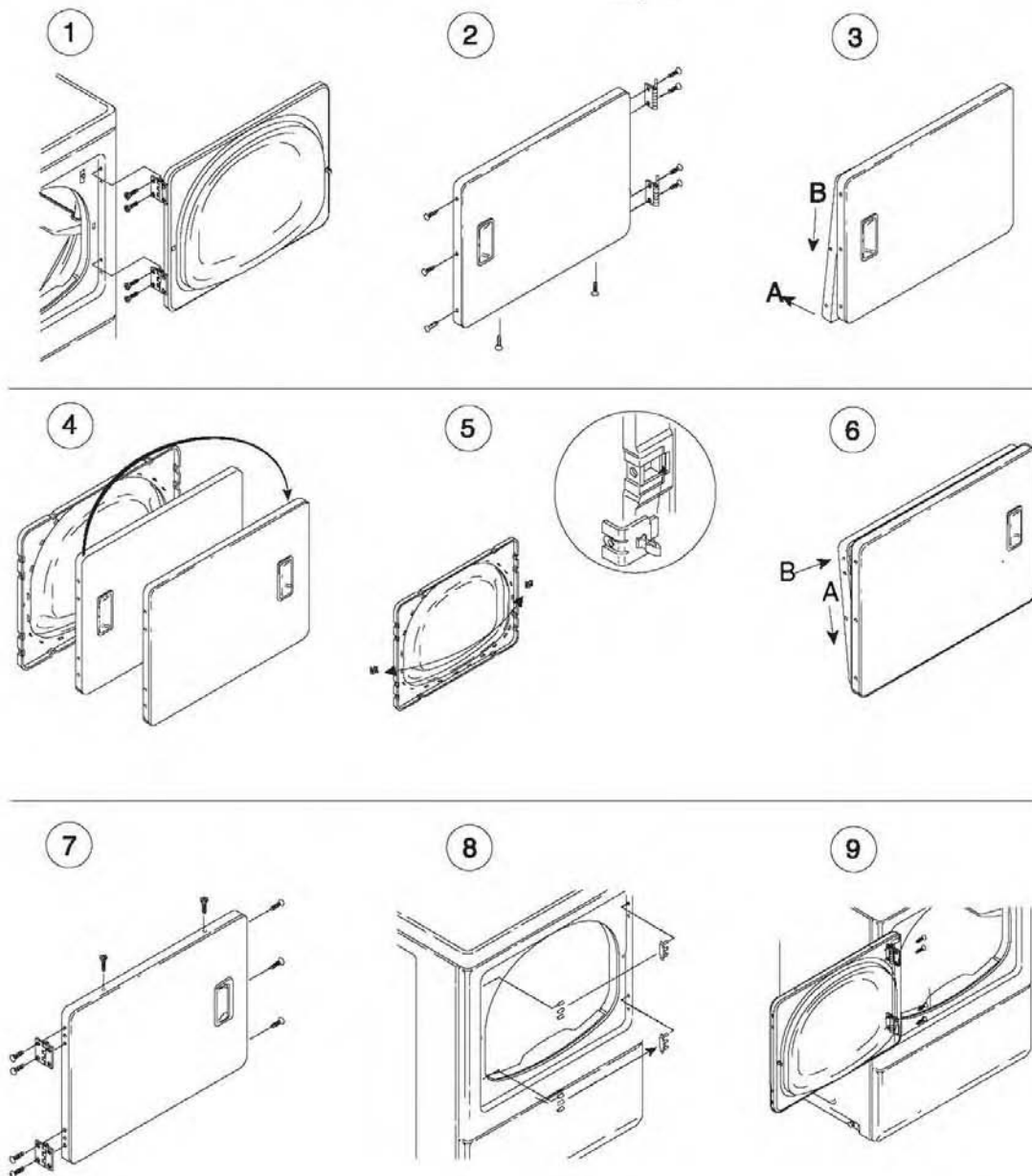



Dryer Exhaust Tips

⚠ WARNING

Plastic or nonmetal flexible duct presents a potential fire hazard.

Do

Read the Installation Instructions and the Use and Care Guide.

DON'T

Let a poor exhaust system cause slow drying.

Do

Let your dryer exhaust the air easily.

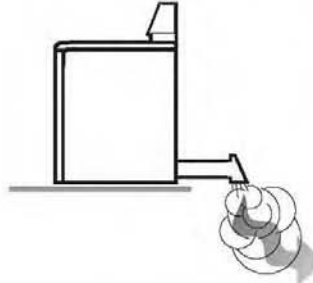

DON'T

Restrict your dryer with a poor exhaust system.

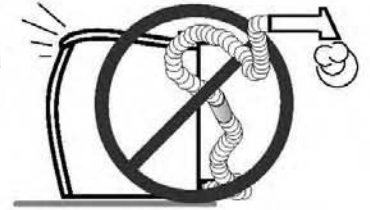

Do

Use 4 inch diameter rigid metal duct. Tape all joints, including at the dryer. Never use lint-trapping screws.

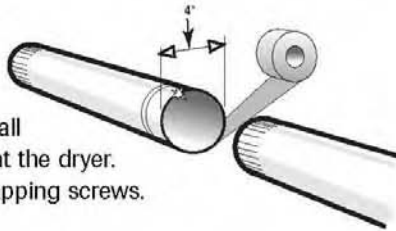

DON'T

Use plastic, thin foil, or non-metal flexible duct.



Do

Keep duct runs as straight as possible.

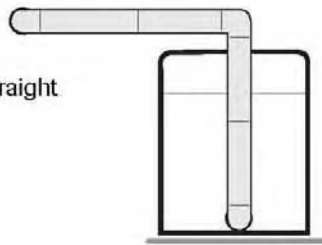

DON'T

Use longer than necessary duct runs with many elbows.

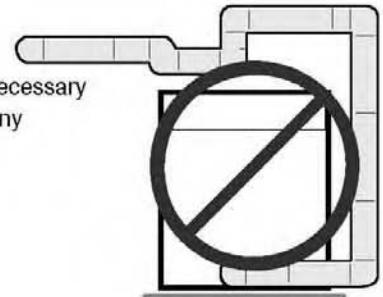

Do

Clean all old ducts before installing your new dryer. Be sure vent flap opens and closes freely. Inspect and clean the exhaust system annually.

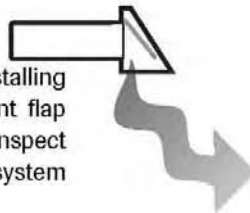

DON'T

Allow crushed or clogged ducts and vent.

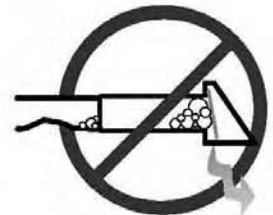

Troubleshooting

Doesn't Run	<ul style="list-style-type: none"> • Be sure the door is shut. • Check to make sure the electrical cord is plugged in. • Check fuse or reset circuit breaker. • Push the control dial in again if the door was opened during the cycle.
Doesn't Heat	<ul style="list-style-type: none"> • Check fuse or reset circuit breaker. • Select a heat setting, not air fluff. • Check that the gas supply is on for gas dryers. • Clean the lint filter and exhaust duct. • Dryer timer may have moved into the cool-down portion of the cycle.
Doesn't Dry Properly	<p>Check all of the above, plus . . .</p> <ul style="list-style-type: none"> • Check the exhaust hood outside the house, make sure it opens and closes freely. • Check exhaust system for lint buildup. Ducting should be inspected and cleaned annually. • Use rigid 4" metal exhaust duct. • Do not overload. 1 wash load = 1 dryer load. • Sort heavy items from lightweight items. • Large, bulky items like blankets or comforters may require repositioning to ensure even drying. • Check the washer to be sure it is draining properly to extract water from the load. • Clothes load is too small to tumble properly. Add a few towels.
Is Noisy	<ul style="list-style-type: none"> • Check the load for objects such as coins, nails, etc. Remove promptly from dryer. • It is normal to hear the dryer gas valve or heating element cycle on and off during the drying cycle. • The dryer should be level and installed on a solid floor. • A clicking noise may be the timer advancing. • It is normal for the dryer to hum due to the high velocity of air moving through the dryer drum and exhaust system.
Control Knob Advances Slowly (select models)	<ul style="list-style-type: none"> • This is normal operation for an Auto Dry cycle, especially at the beginning of cycle. Once the load begins to dry, the control knob will start to advance. The rate of advancement will be slow at the beginning of the cycle because there is more moisture in the load. As the load becomes more dry, the control knob will advance more quickly.
Dries Unevenly	<ul style="list-style-type: none"> • Seams, pockets and other similar heavy areas may not be completely dry when the rest of the load has reached the selected dryness level. This is normal. Select the More Dry setting if desired. • If one heavy item is dried with a lightweight load, such as one towel with sheets, it is possible that the heavy item will not be completely dry when the rest of the load has reached the selected dryness level. Sort heavy items from lightweight items for best drying results.
Has an Odor	<ul style="list-style-type: none"> • Household odors such as from painting, varnishing, strong cleaners, etc. may enter the dryer with the surrounding room air. This is normal as the dryer draws the air from the room, heats it, pulls it through the tumbler and exhausts it to the outside. When these odors are present in the air, ventilate the room completely before using the dryer.

For further assistance contact Maytag ServicesSM, Customer Assistance: U.S.A. 1-800-688-9900 or Canada 1-800-688-2002. U.S.A. Customers using TTY for deaf, hearing impaired or speech impaired, call 1-800-688-2080.