



CONSUMER SERVICES TECHNICAL
EDUCATION GROUP PRESENTS

L-72

DryAire™ DRYING CABINET

Model LMA1053L



JOB AID
Part No. 8178202

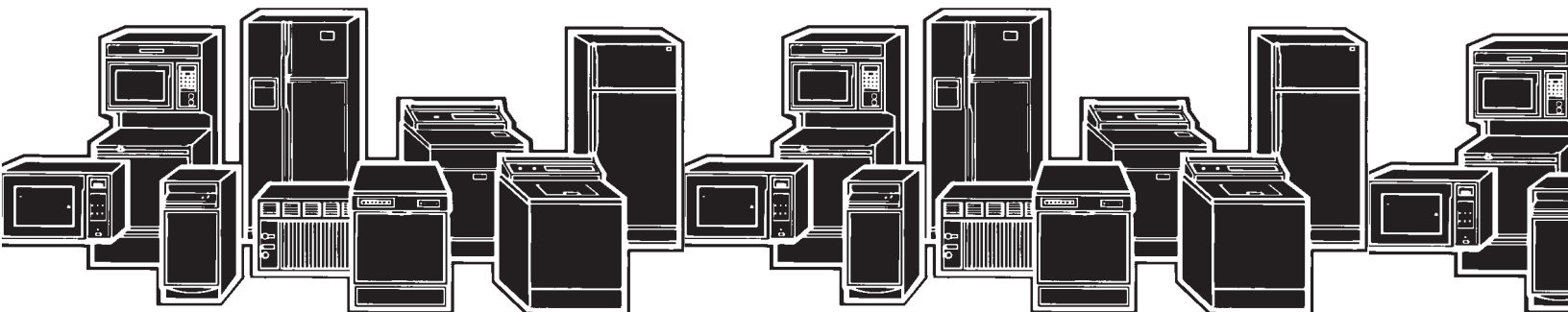

FORWARD

This Whirlpool Job Aid, "DryAire™ Drying Cabinet," (Part No. 8178202), provides the technician with information on the installation, operation, and service of the DryAire™ Drying Cabinet. It is to be used as a training Job Aid and Service Manual.

The Wiring Diagram used in this Job Aid is typical and should be used for training purposes only. Always use the Wiring Diagram supplied with the product when servicing the unit.

GOALS AND OBJECTIVES

The goal of this Job Aid is to provide detailed information that will enable the service technician to properly diagnose malfunctions and repair the Whirlpool DryAire™ Drying Cabinet.

The objectives of this Job Aid are to:

- Understand and follow proper safety precautions.
- Successfully troubleshoot and diagnose malfunctions.
- Successfully perform necessary repairs.
- Successfully return the Drying Cabinet to its proper operational status.

WHIRLPOOL CORPORATION assumes no responsibility for any repairs made on our products by anyone other than Authorized Service Technicians.

TABLE OF CONTENTS

	Page
GENERAL	1-1
Safety First	1-1
Model & Serial Number Designations	1-2
Model & Serial Number Label & Wiring Diagram Locations	1-3
Specifications	1-4
Whirlpool DryAire Drying Cabinet Warranty	1-5
INSTALLATION INFORMATION	2-1
Mounting The Cabinet	2-1
Changing The Door Swing	2-2
PRODUCT OPERATION	3-1
Drying Clothes	3-1
Controls & Switches	3-2
COMPONENT ACCESS	4-1
Component Locations	4-1
Removing The Component Panel	4-2
Removing The High Limit Thermostat And The Heater	4-3
Removing The Timer	4-4
Removing The Blower Assembly, The Thermostat & Temperature Sensor	4-5
Removing The Relay	4-6
Removing The Push-To-Start & Door Switches	4-7
Removing The Component Panel-Mounted Terminal Block	4-8
Removing The Power Cord And Cabinet-Mounted Terminal Block	4-9
Removing The Cabinet Door	4-10
COMPONENT TESTING	5-1
High Limit Thermostat	5-1
Heater	5-1
Fan Motor	5-2
Thermostat	5-2
Timer	5-3
Door & Push-To-Start (PTS) Switches	5-3
WIRING DIAGRAM	6-1

— NOTES —

GENERAL SAFETY FIRST

Your safety and the safety of others is very important.

We have provided many important safety messages in this Job Aid and on the appliance. Always read and obey all safety messages.



This is the safety alert symbol.

This symbol alerts you to hazards that can kill or hurt you and others.

All safety messages will follow the safety alert symbol and either the word "DANGER" or "WARNING." These words mean:

! DANGER

You can be killed or seriously injured if you don't immediately follow instructions.

! WARNING

You can be killed or seriously injured if you don't follow instructions.

All safety messages will tell you what the potential hazard is, tell you how to reduce the chance of injury, and tell you what can happen if the instructions are not followed.

ELECTRICAL POWER SUPPLY & GROUNDING REQUIREMENTS

! WARNING



Electrical Shock Hazard

Disconnect power before servicing.

Replace all parts and panels before operating.

Failure to do so can result in death or electrical shock.

! WARNING



Electrical Shock Hazard

Plug into a grounded 3-prong outlet.

Do not remove ground prong.

Do not use an adapter.

Do not use an extension cord.

Failure to follow these instructions can result in death, fire, or electrical shock.

MODEL & SERIAL NUMBER DESIGNATIONS

MODEL NUMBER

MODEL NUMBER	L	M	A	10	5	3	L	Q	0
INTERNATIONAL SALES IND. OR MARKETING CHANNEL IF PRESENT									
PRODUCT GROUP: L = DOMESTIC LAUNDRY									
PRODUCT IDENTIFICATION: M = DRYING CABINET									
FEATURE CODE 1: A = BUILT-IN VERSION									
FEATURE CODE 2: <i>FIRST DIGIT</i> 1 = CYCLES 1 THROUGH 9 <i>SECOND DIGIT</i> 0 = TIME DRY ONLY									
FEATURE CODE 3: 1 TO 7 = TEMPERATURE SELECTIONS									
FEATURE CODE 4: 3 = REGULAR CAPACITY									
YEAR OF INTRODUCTION: L = 2002, M = 2003									
COLOR CODE: Q = WHITE-ON-WHITE T = BISCUIT-ON-BISCUIT									
ENGINEERING CHANGE (NUMERIC)									

SERIAL NUMBER

SERIAL NUMBER	M	A	M	04	54321
DIVISION RESPONSIBILITY M = MARION, OH					
MANUFACTURING SOURCE A = NIMO-VERKEN AB					
YEAR OF PRODUCTION: M = 2002					
WEEK OF PRODUCTION: 04 = 4th WEEK					
PRODUCT SEQUENCE NUMBER					

MODEL & SERIAL NUMBER LABEL & WIRING DIAGRAM LOCATIONS

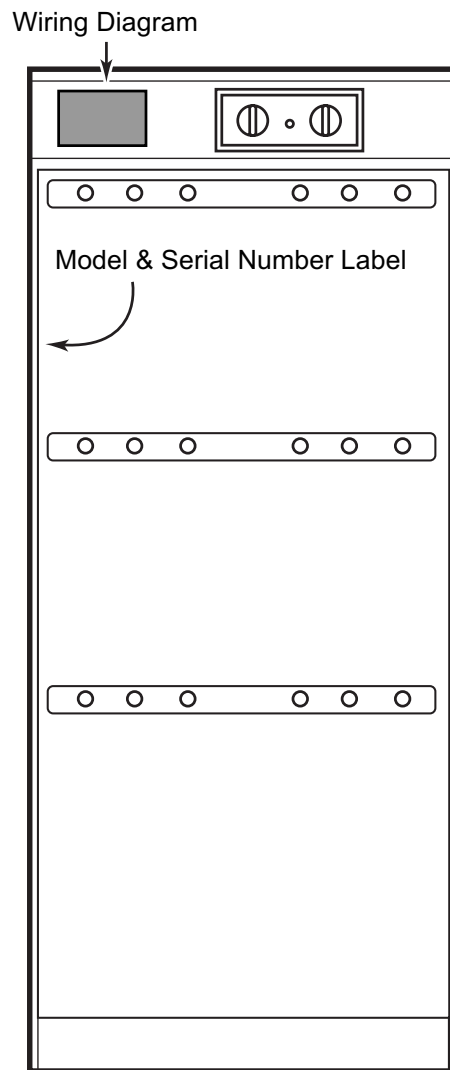

SPECIFICATIONS

Model No.	LMA1053LQ, T
Color	Q = White, T = Biscuit
Dimensions/Weight:	
Overall Height	170.8 cm (67-1/4")
Cabinet Width	59.5 cm (23-1/2")
Cabinet Depth	61 cm (24")
Capacity (dry load)	3.5 kg (7.7 lbs.)
Weight	56 kg (123 lbs.)
Cycle Configuration:	
Temperature	Room Temperature to 65.6°C (150°F)
Time Selection	0 - 4 Hrs.
General:	
Voltage	120 VAC
Amperage	12 Amps (max.)
Drainage Capacity	.02 kg/min (0.6 oz/min)
Heating Element Rating	1200 Watts
Overheating Cutout	Yes
Motor Rating	35 Watts
Fan Capacity	10 CFM (180 Cu. Meter-Per-Hr.)
Exhaust Vent Location	Top Of Unit
Reversible Door	Yes
Racks	3 Slide Out, 2 Foldable
Color	White
Warranty	1 Year, Parts & Labor

WHIRLPOOL DryAire™ DRYING CABINET WARRANTY

LENGTH OF WARRANTY:	WHIRLPOOL WILL PAY FOR:	WHIRLPOOL WILL NOT PAY FOR:
<p>FULL ONE-YEAR WARRANTY FROM DATE OF PURCHASE.</p>	<p>FSP® replacement parts and repair labor costs to correct defects in materials or workmanship. Service must be provided by a Whirlpool-designated service company.</p>	<p>A. Service calls to:</p> <ol style="list-style-type: none"> 1. Correct the installation of the unit. 2. Replace house fuses or correct house wiring. 3. Replace owner-accessible light bulbs. <p>B. Repairs when the unit is used in other than normal, single-family household use.</p> <p>C. Pickup and delivery. The unit is designed to be repaired in the home.</p> <p>D. Damage to the unit caused by accident, alteration, misuse, abuse, fire, flood, acts of God, or use of products not approved by Whirlpool.</p> <p>E. Repairs to parts or systems resulting from unauthorized modifications made to the unit.</p>

WHIRLPOOL CORPORATION SHALL NOT BE LIABLE FOR INCIDENTAL OR CONSEQUENTIAL DAMAGES.

Some states or provinces do not allow the exclusion or limitation of incidental or consequential damages, so this exclusion or limitation may not apply to you. This warranty gives specific legal rights and you may also have other rights which vary from state to state or province to province.

Outside the United States and Canada, a different warranty may apply. For details, please contact your authorized Whirlpool dealer.

If you need service, help can be found by checking the "Assistance Or Service" section of the Use and Care Guide, or by calling the Whirlpool Customer Interaction Center telephone number, **1-800-253-1301**, from anywhere in the U.S.A.

— NOTES —

INSTALLATION INFORMATION

MOUNTING THE CABINET

NOTE: This drying cabinet is intended to be vented into the room. Do not vent it into a chimney, wall, or ceiling exhaust duct.

1. Place the DryAire™ Drying Cabinet in its mounting location.
2. Using the special hex wrench provided, adjust the leveling legs so that the cabinet is level front-to-back and side-to-side.

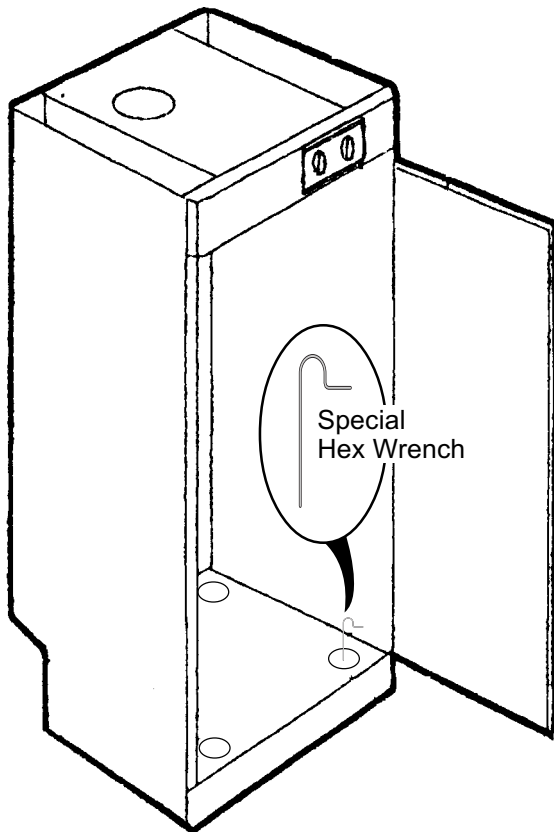

3. Install the plastic plugs provided with the unit and place them into the leveling leg holes.
4. Secure the top of the cabinet to the wall with the hardware provided.

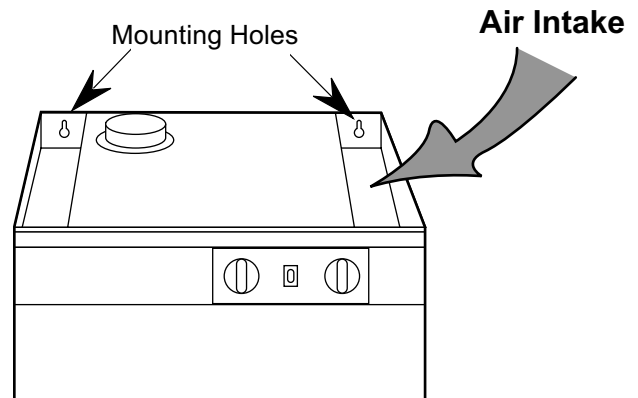

CHANGING THE DOOR SWING

To reverse the way the cabinet door swings open and closed, perform the following steps.

1. Close the cabinet door.
2. Pry the plastic hole plugs from the cabinet.
3. Use a screwdriver and remove the lower pivot pin from the door hinge.
4. Carefully open the cabinet door and remove the door.
5. Turn the door 180° so that the door handle is on the opposite side.
6. Use the screwdriver, and install the upper pivot pin into the pivot hole, and align the bottom of the door with the lower pivot hole.
7. Install the lower pivot pin into the pivot hole.
8. Close the cabinet door and install the plastic plugs into the hinge holes.

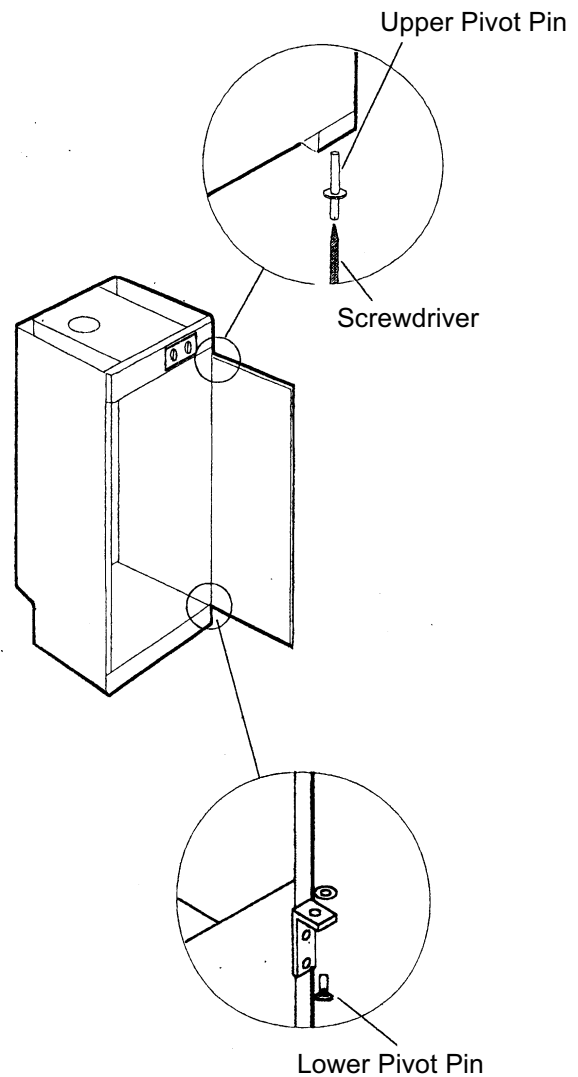

PRODUCT OPERATION

DRYING CLOTHES

The dryer contains three racks with hanger bars. The racks can be pulled out on rails to allow for easier loading and hanging, as well as for convenience.

To use the drying racks, pull the racks toward you as far as they will go, hang the clothing, and push the racks back in.

Note the wide space in the middle of each hanging section. This space allows air to flow around the clothing during drying. The spaces should not be blocked, otherwise, it could have a negative effect on the drying efficiency.

When hanging clothing to dry, keep the longer articles, such as pants and dresses, toward the dryer walls of the cabinet, and shorter articles, such as shirts and sweaters, toward the middle. This will allow the best airflow around the clothing for optimum drying efficiency.

The racks may be folded up out of the way by rotating the front up against the back wall.

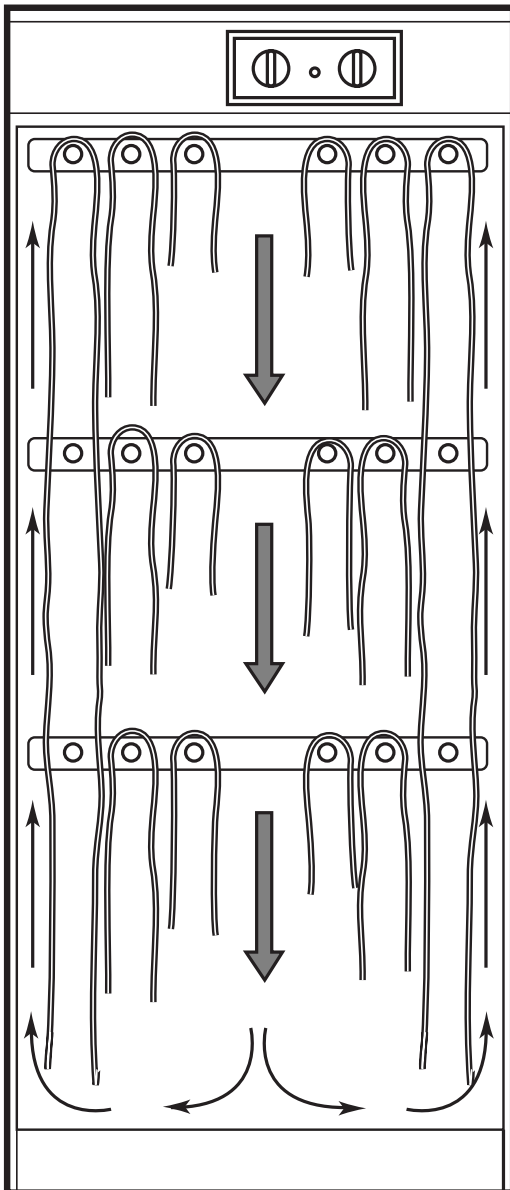

Rack In Down Position



Rack In Up Position

CONTROLS & SWITCHES

The control panel has two controls and two switches, which perform the following functions:

Heating Control—controls the temperature of the air circulating inside the cabinet. The control ranges are from “air only,” (the “0” position), to normal drying, to “fast drying.”

Timer Control—allows timed drying for up to 4 hours.

Push-To-Start (PTS) Switch—starts the drying cycle.

Door Switch—allows the unit to operate with the door closed. The unit will not operate with the door open.

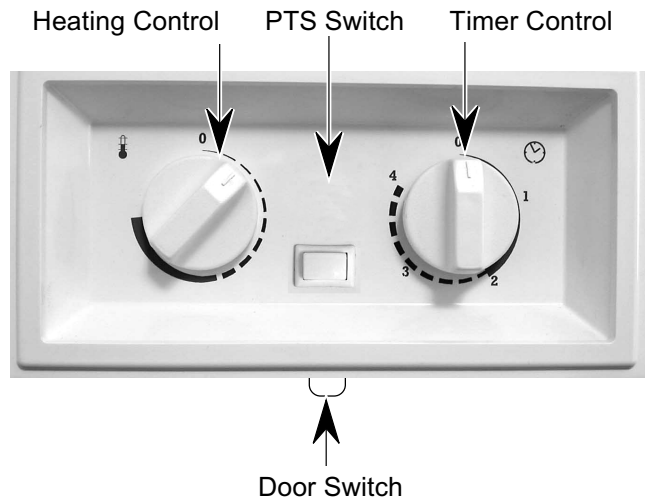

COMPONENT ACCESS

COMPONENT LOCATIONS

The components that are serviced in this section of the Job Aid are shown below.

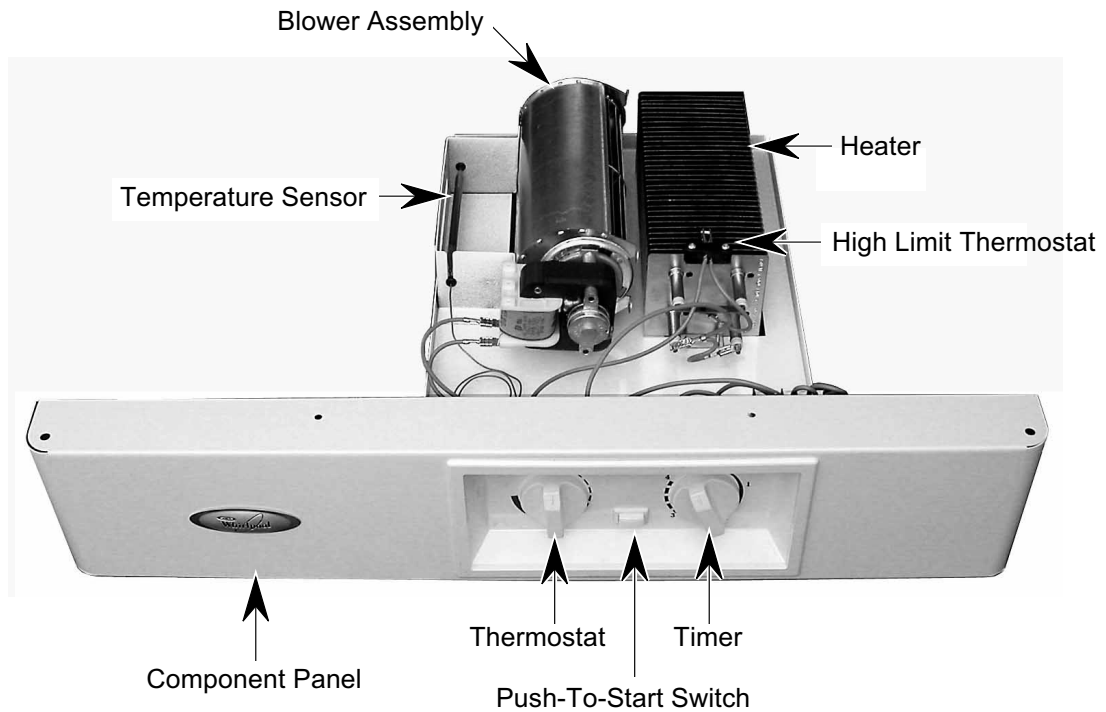

Inside Of Component Panel

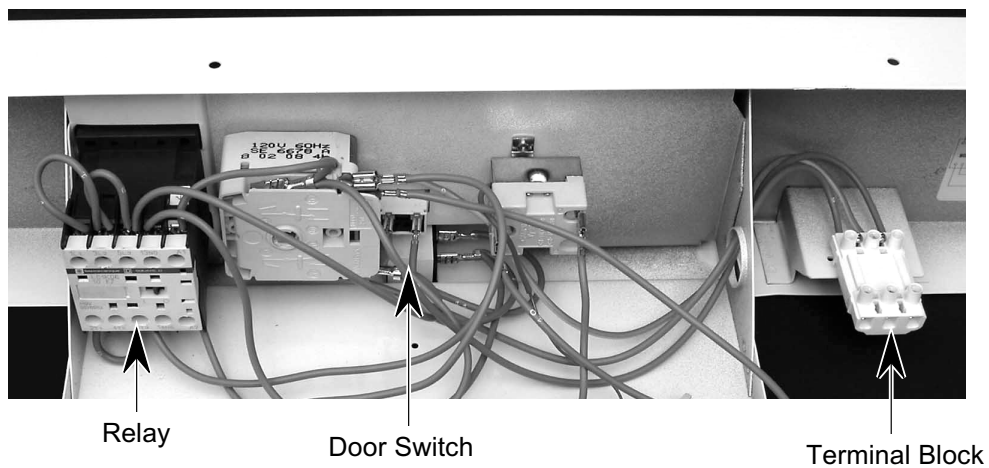

REMOVING THE COMPONENT PANEL

!WARNING



Electrical Shock Hazard
Disconnect power before servicing.
Replace all parts and panels before operating.
Failure to do so can result in death or electrical shock.

NOTE: Sharp edges may be present.

1. Disconnect the power to the drying cabinet.
2. Open the cabinet door.

3. Remove the mounting screw from the bottom of the component panel.



Component Panel Screw

4. Pull the component panel out of the cabinet and set it on a work surface.

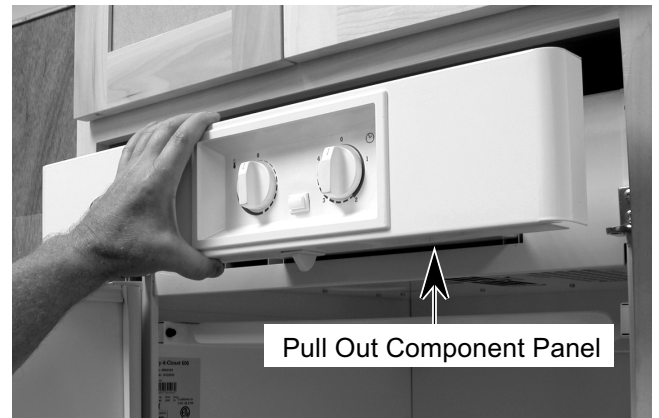

REMOVING THE HIGH LIMIT THERMOSTAT AND THE HEATER

⚠️ WARNING



Electrical Shock Hazard
Disconnect power before servicing.
Replace all parts and panels before operating.
Failure to do so can result in death or electrical shock.

NOTE: Sharp edges may be present.

1. Disconnect the power to the drying cabinet.
2. Remove the component panel (see page 4-2 for the procedure).
3. **To remove the high limit thermostat:**
 - a) Disconnect the wires going to the heater and thermostat terminals.
 - b) Remove the two Torx screws.

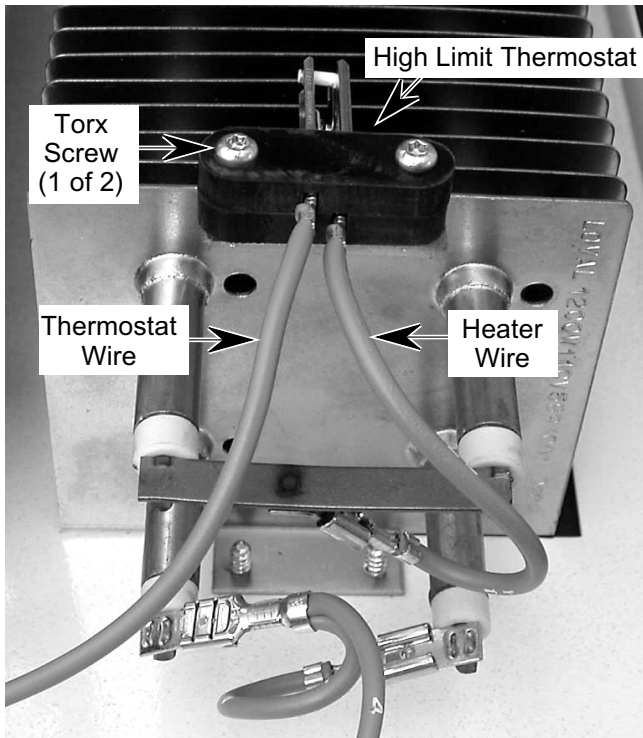

4. **To remove the heater:**
 - a) Remove the two Torx screws from the high limit thermostat.
 - b) Disconnect the three wires from the heater terminals.

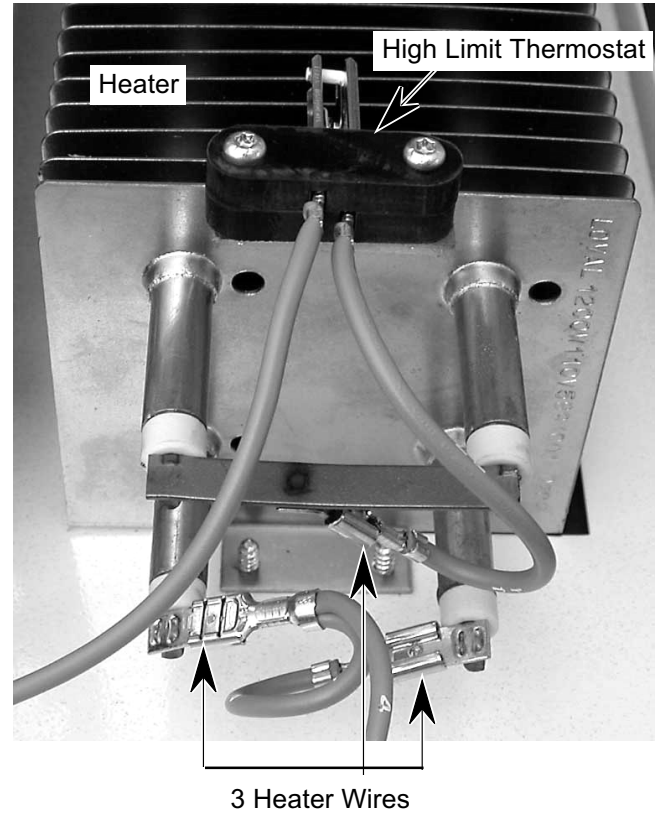

- c) Turn the component shelf over and remove the four screws from the front and rear heater brackets.

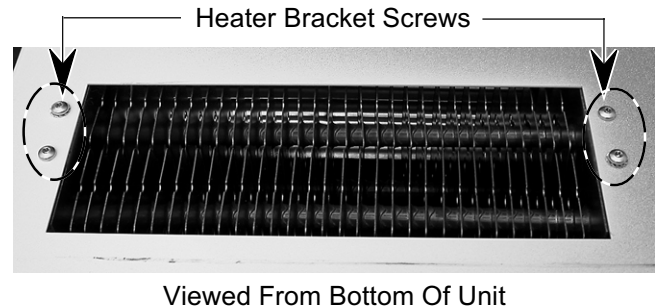

REMOVING THE TIMER

⚠ WARNING



Electrical Shock Hazard
Disconnect power before servicing.
Replace all parts and panels before operating.
Failure to do so can result in death or electrical shock.

NOTE: Sharp edges may be present.

1. Disconnect the power to the drying cabinet.
2. Remove the component panel (see page 4-2 for the procedure).
3. Remove the two mounting screws and lockwasher from the shield and remove the shield from the component panel.

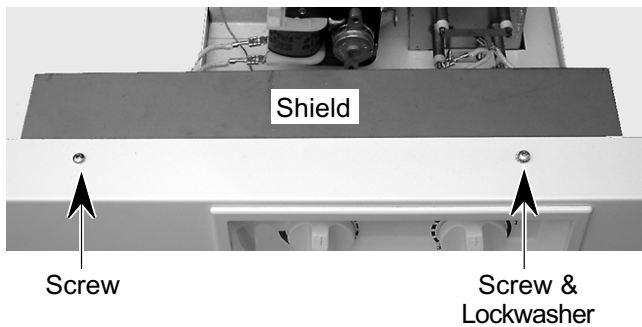

4. Remove the knob from the timer shaft.

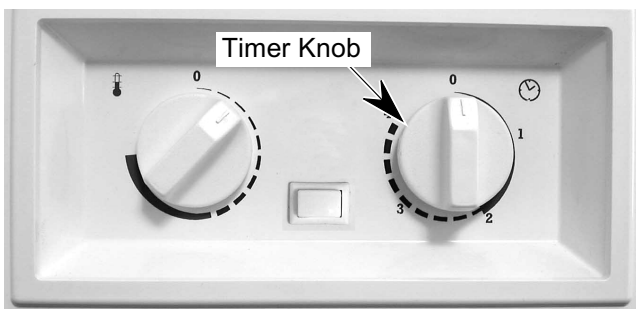

5. Remove the two screws and lockwashers from the timer.



6. Disconnect the wires from the thermostat terminals. NOTE: Be sure to reconnect the wires to the proper thermostat terminals.

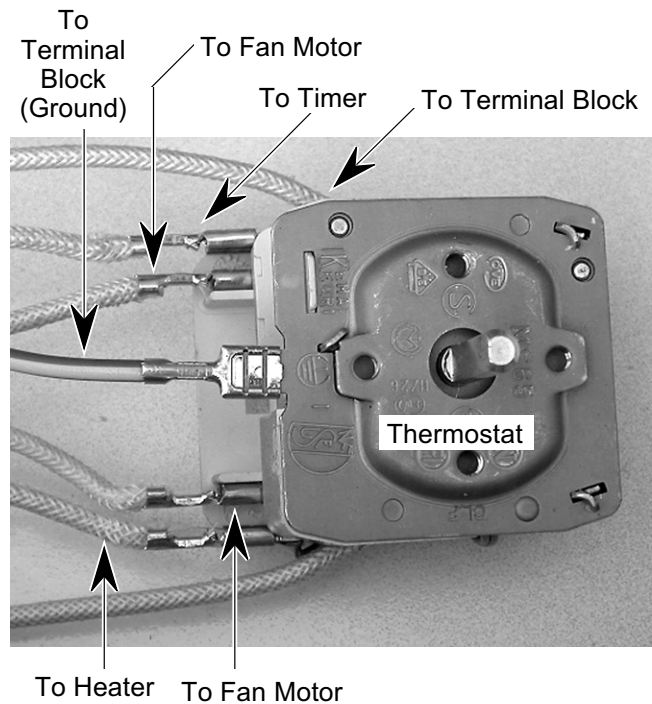

REMOVING THE BLOWER ASSEMBLY, THE THERMOSTAT & TEMPERATURE SENSOR

!WARNING



Electrical Shock Hazard
Disconnect power before servicing.
Replace all parts and panels before operating.
Failure to do so can result in death or electrical shock.

NOTE: Sharp edges may be present.

1. Disconnect the power to the drying cabinet.
2. Remove the component panel (see page 4-2 for the procedure).
3. **To remove the blower assembly:**
 - a) Disconnect the wires from the fan motor terminals.
 - b) Remove the four screws from the blower assembly and remove it.

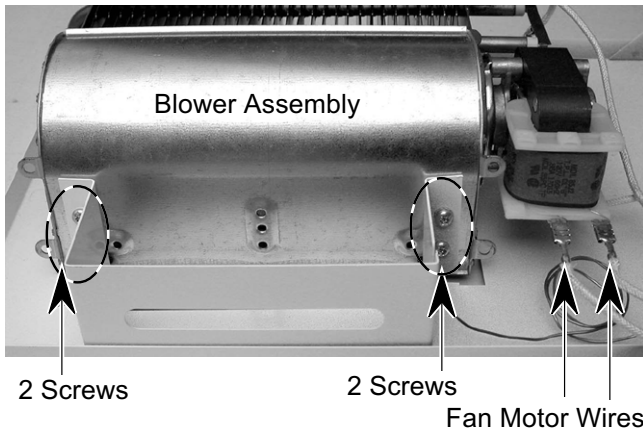

4. **To remove the thermostat and temperature sensor:**
 - a) Remove the two mounting screws and lockwasher from the shield and remove the shield from the component panel (see the photo in step 3 on the previous page).

- b) Remove the knob from the thermostat control shaft.

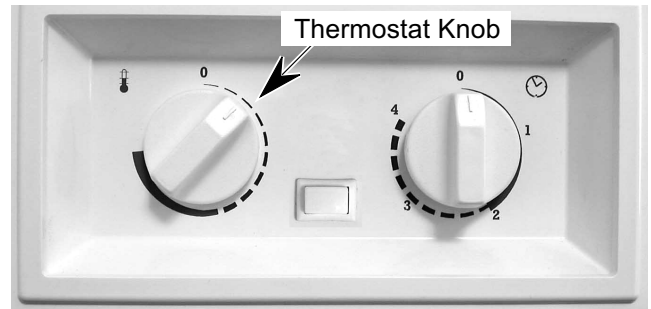

- c) Remove the two screws and lockwashers from the thermostat.

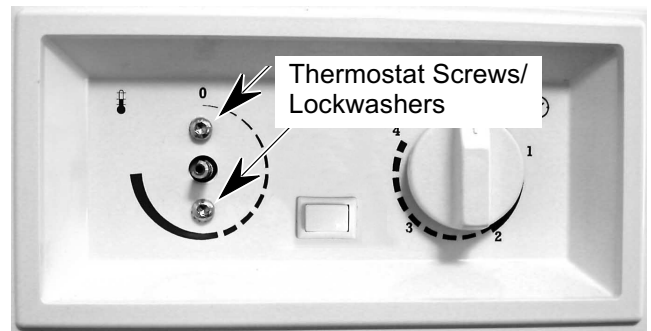

- d) Disconnect the wires from the thermostat terminals.
- e) Slide the sensor tube out of the slotted rubber grommet, and then pull the end of the sensor from the other rubber grommet.

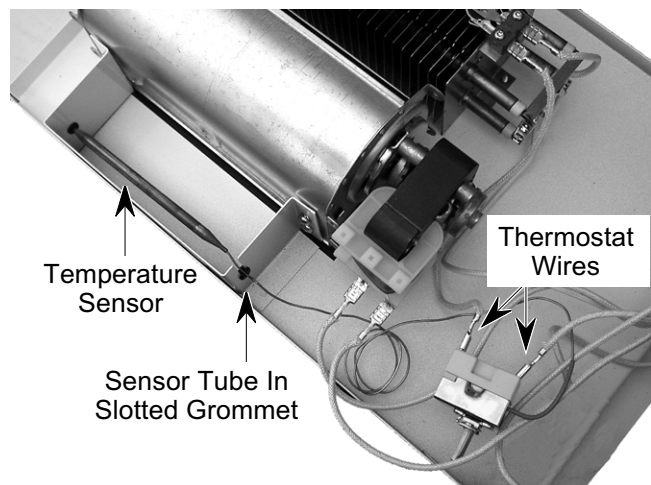

REMOVING THE RELAY

⚠ WARNING



Electrical Shock Hazard
Disconnect power before servicing.
Replace all parts and panels before operating.
Failure to do so can result in death or electrical shock.

NOTE: Sharp edges may be present.

1. Disconnect the power to the drying cabinet.
2. Remove the component panel (see page 4-2 for the procedure).

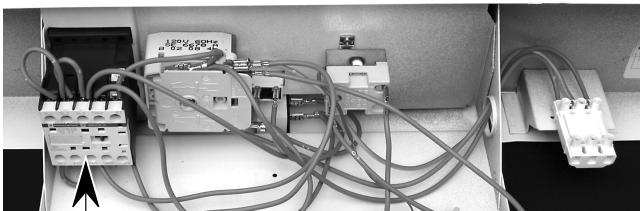

Relay

3. Remove the two mounting screws and lockwasher from the shield and remove the shield from the component panel.

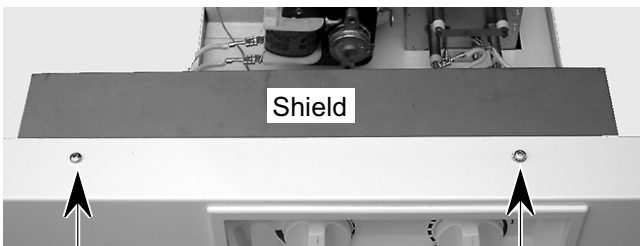

Shield

Screw

Screw & Lockwasher

4. Push down on the top of the relay case and rotate the lower rear up to unclip the relay from the front panel.

Push Down On Front Of Relay Case

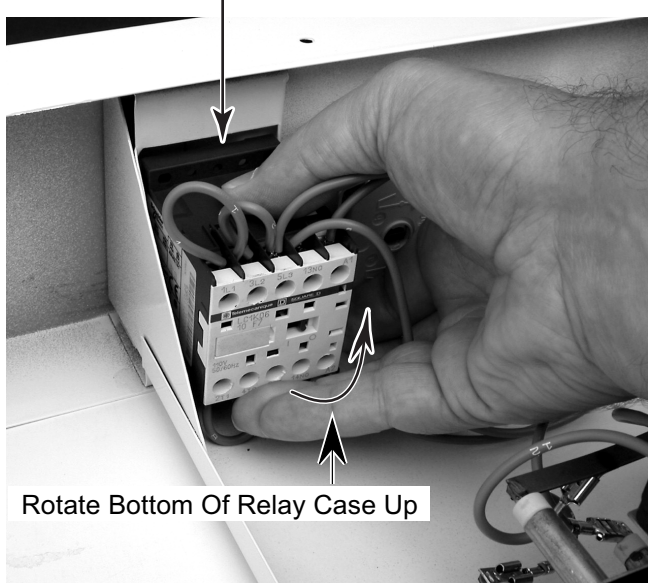

Rotate Bottom Of Relay Case Up

5. One at a time, loosen a wire setscrew and pull the wire(s) out of the relay connector. Connect the end of the wire(s) to the terminal with the same letter/number callout on the replacement relay. This will help you rewire the new relay properly.

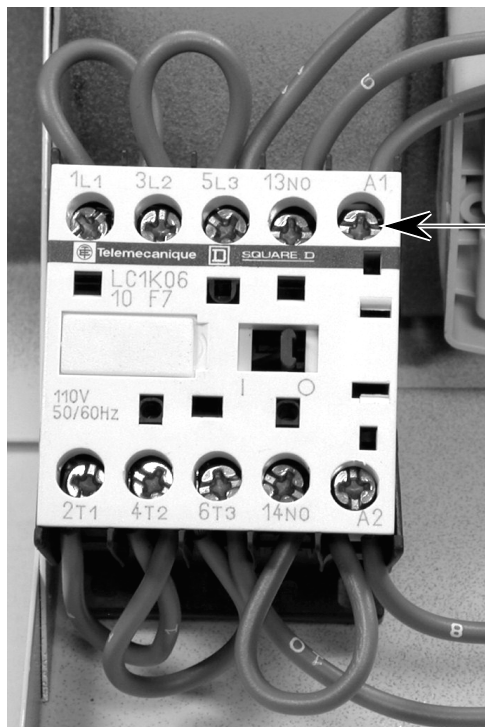

Terminal Screw

REMOVING THE PUSH-TO-START & DOOR SWITCHES

!WARNING



Electrical Shock Hazard
Disconnect power before servicing.
Replace all parts and panels before operating.
Failure to do so can result in death or electrical shock.

NOTE: Sharp edges may be present.

1. Disconnect the power to the drying cabinet.
2. Remove the component panel (see page 4-2 for the procedure).
3. Remove the two mounting screws and lockwasher from the shield and remove the shield from the component panel.

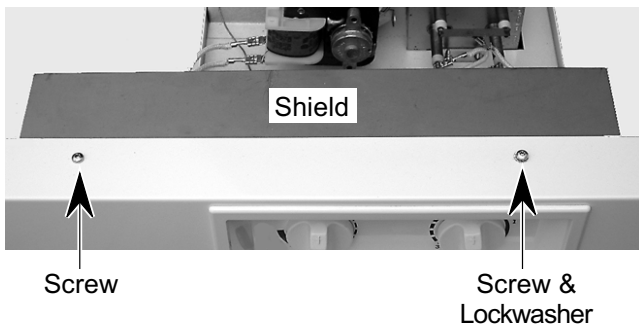

4. To remove the push-to-start (PTS) switch or the door switch:
 - a) Disconnect the wires from the terminals.
 - b) Press in on the locking arms and push the switch out of the front panel cutout.

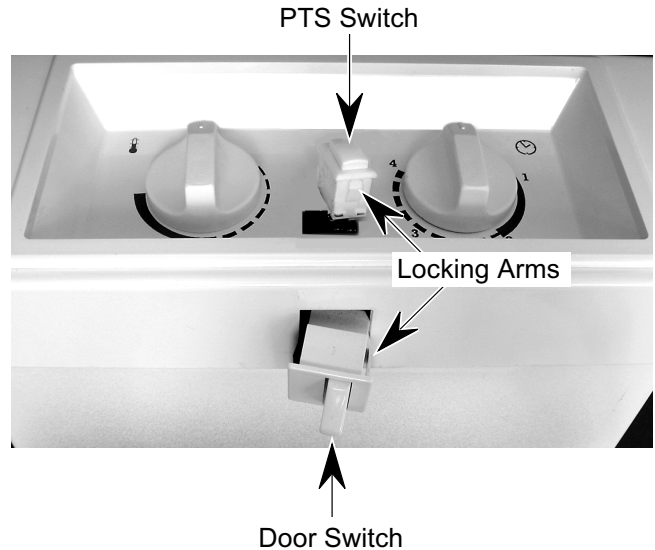

REMOVING THE COMPONENT PANEL-MOUNTED TERMINAL BLOCK

!WARNING



Electrical Shock Hazard

Disconnect power before servicing.

Replace all parts and panels before operating.

Failure to do so can result in death or electrical shock.

NOTE: Sharp edges may be present.

1. Disconnect the power to the drying cabinet.
2. Remove the component panel (see page 4-2 for the procedure).
3. Remove the two mounting screws and lockwasher from the shield and remove the shield from the component panel.

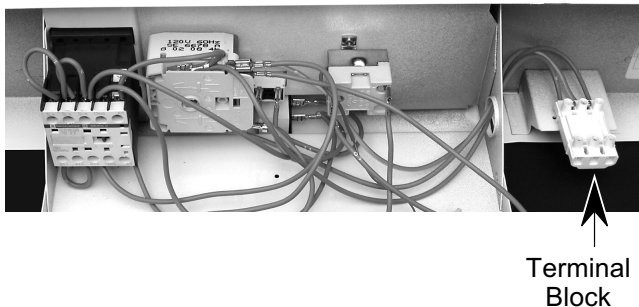
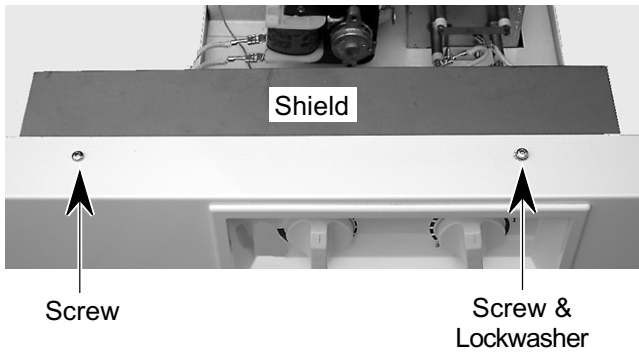

4. Loosen the 3 wire screws and pull the wires out of the component panel-mounted terminal block.
5. Remove the two screws from the component panel-mounted terminal block, and remove the block from its mounting bracket.

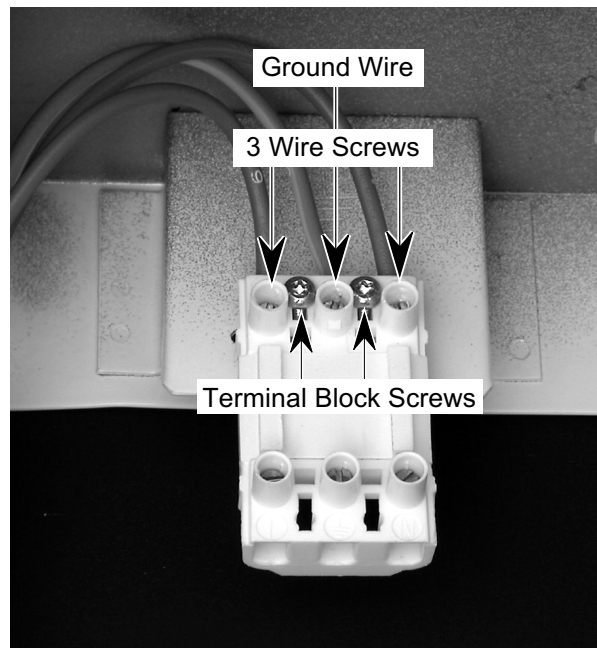

!WARNING



Electrical Shock Hazard

Connect ground wire to ground screw.

Failure to do so can result in death or electrical shock.

REMOVING THE POWER CORD AND CABINET-MOUNTED TERMINAL BLOCK

!WARNING



Electrical Shock Hazard
Disconnect power before servicing.
Replace all parts and panels before operating.
Failure to do so can result in death or electrical shock.

NOTE: Sharp edges may be present.

1. Disconnect the power to the drying cabinet.
2. Remove the component panel (see page 4-2 for the procedure).
3. **To remove the power cord:**
 - a) Remove the nut from the ground wire stud, and remove the green power cord wire from the stud.
 - b) Loosen the two power cord strain relief clamp screws.
 - c) Loosen the 3 wire screws in the cabinet-mounted terminal block, pull the black, white, and green/yellow power cord wires out of the terminals, and remove the cord from the cabinet. NOTE: Make sure that you reconnect the correct wires to the terminal block screws, as shown in the photo.
4. **To remove the cabinet-mounted terminal block:**
 - a) Perform step 3c.
 - b) Remove the two cabinet-mounted terminal block screws, and remove the block from its mounting bracket.



Strain Relief Clamp Screws Power Cord

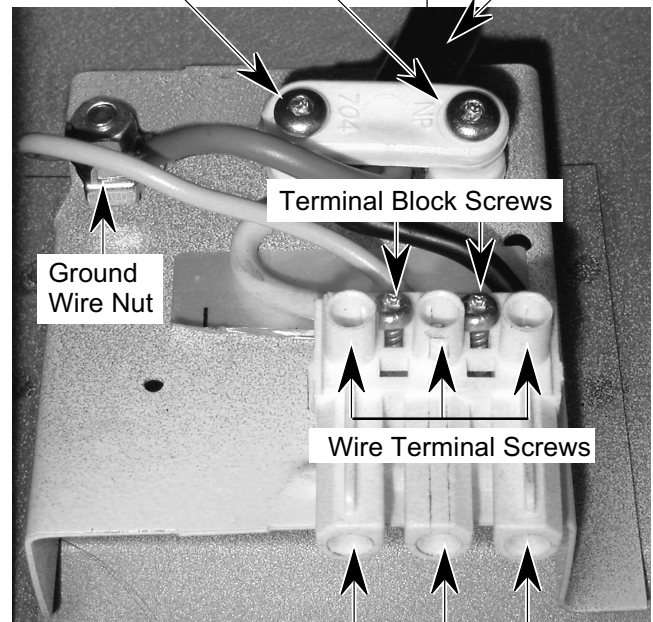

Wht / Yel / Blk Wires

!WARNING



Electrical Shock Hazard
Connect ground wire to ground screw.
Failure to do so can result in death or electrical shock.

REMOVING THE CABINET DOOR

! WARNING



Electrical Shock Hazard
Disconnect power before servicing.
Replace all parts and panels before operating.
Failure to do so can result in death or electrical shock.

NOTE: Sharp edges may be present.

1. Disconnect the power to the drying cabinet.
2. Remove the component panel (see page 4-2 for the procedure).

3. With the cabinet door closed, remove the two screws from the top pivot bracket and remove the bracket.

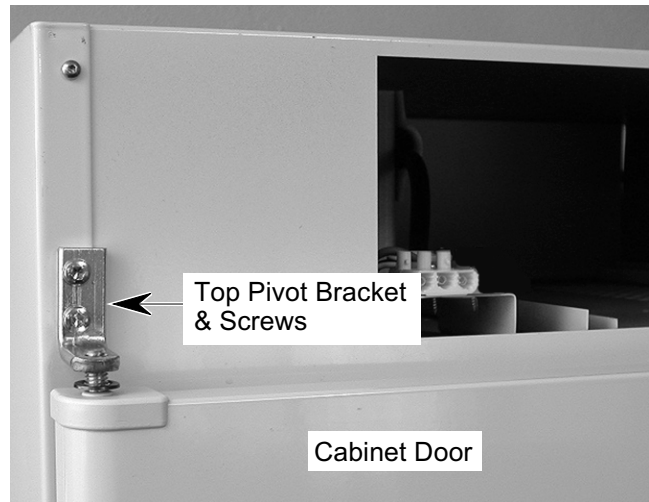

4. Carefully open the cabinet door, lift the bottom pivot pin out of the bracket, and remove the door.

COMPONENT TESTING

Before testing any of the components, perform the following checks:

- The most common cause for control failure is corrosion on connectors. Therefore, disconnecting and reconnecting wires will be necessary throughout test procedures.
- All tests/checks should be made with a VOM or DVM having a sensitivity of 20,000 ohms-per-volt DC, or greater.
- Check all connections before replacing components, looking for broken or loose wires, failed terminals, or wires not pressed into connectors far enough.
- Resistance checks must be made with power cord unplugged from outlet, and with wiring harness or connectors disconnected.



⚠ WARNING

Electrical Shock Hazard

Disconnect power before servicing.

Replace all parts and panels before operating.

Failure to do so can result in death or electrical shock.

HIGH LIMIT THERMOSTAT

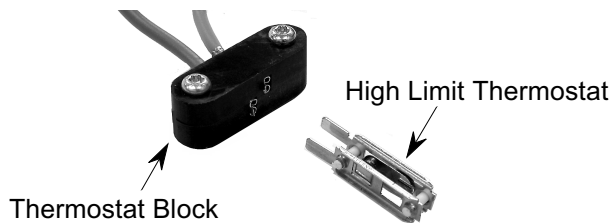

Refer to page 4-3 for the procedure for servicing the high limit thermostat.

1. Disconnect the power to the drying cabinet.
2. Set the ohmmeter to the R x 1 scale.
3. Pull the high limit thermostat out of the thermostat block.
4. Touch the ohmmeter leads to the two contacts on the high limit thermostat. The meter should indicate 0 Ω .

HEATER

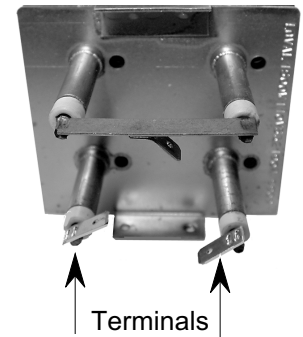
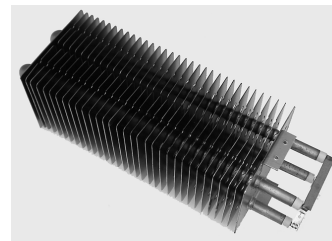

Refer to page 4-3 for the procedure for servicing the heater.

1. Disconnect the power to the drying cabinet.
2. Disconnect the wires from the two bottom terminals of the heater.
3. Set the ohmmeter to the R x 1 scale.
4. Touch the ohmmeter leads to the two bottom heater terminals. The meter should indicate between 20 and 40 Ω .



⚠ WARNING

Electrical Shock Hazard

Disconnect power before servicing.

Replace all parts and panels before operating.

Failure to do so can result in death or electrical shock.

FAN MOTOR

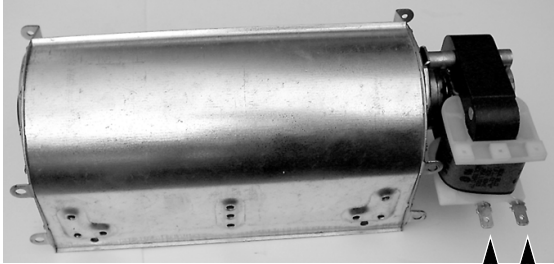

Fan Motor Terminals

Refer to page 4-5 for the procedure for servicing the blower assembly.

1. Disconnect the power to the drying cabinet.
2. Disconnect one of the wires from the fan motor terminals.
3. Set the ohmmeter to the R x 1 scale.
4. Touch the ohmmeter leads to the fan motor terminals. The meter should indicate between 8 and 16 Ω .

THERMOSTAT

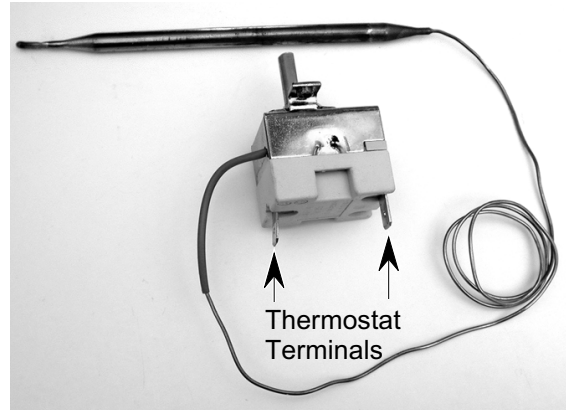

Thermostat Terminals

Refer to page 4-5 for the procedure for servicing the thermostat.

1. Disconnect the power to the drying cabinet.
2. Disconnect the wire from one of the thermostat terminals.
3. Turn the thermostat to 0 (off).
4. Set the ohmmeter to the R x 1 scale.
5. Touch the ohmmeter leads to the thermostat terminals. The meter should indicate an open (infinite) circuit.
6. Turn the thermostat knob clockwise until you hear it click.
7. Touch the ohmmeter leads to the thermostat terminals. The meter should indicate a closed circuit (0 Ω).



⚠ WARNING

Electrical Shock Hazard

Disconnect power before servicing.

Replace all parts and panels before operating.

Failure to do so can result in death or electrical shock.

TIMER

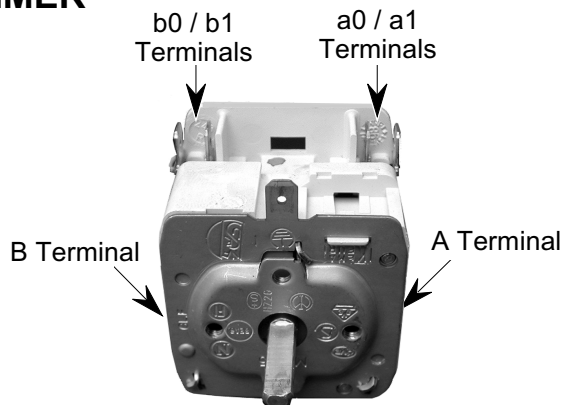

Refer to page 4-4 for the procedure for servicing the timer.

1. Disconnect the power to the drying cabinet.
2. Disconnect the wires from the A and a0/a1 terminals, and the B and b0/b1 terminals.
3. Turn the timer to 0 (off).
4. Set the ohmmeter to the R x 1 scale.
5. Touch the ohmmeter leads to the A and a0/a1 terminals. The meter should indicate an open (infinite) circuit.
6. Touch the ohmmeter leads to the B and b0/b1 terminals. The meter should indicate an open (infinite) circuit.
7. Turn the timer to the 1 (On) position.
8. Repeat steps 5 and 6. The meter should indicate a closed circuit ($0\ \Omega$) in both steps.

DOOR & PUSH-TO-START (PTS) SWITCHES



Door Switch

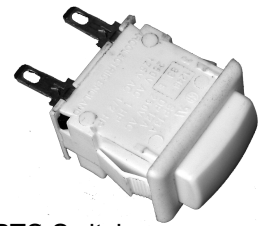

PTS Switch

Refer to page 4-7 for the procedure for servicing the door and push-to-start switches.

1. Disconnect the power to the drying cabinet.
2. Disconnect one of the wires from the door switch or the push-to-start switch terminals.
3. Set the ohmmeter to the R x 1 scale.
4. Touch the ohmmeter leads to the switch terminals. The meter should indicate an open (infinite) circuit.
5. Press the switch actuator.
6. Touch the ohmmeter leads to the switch terminals. The meter should indicate a closed circuit ($0\ \Omega$).

— NOTES —

WIRING DIAGRAM

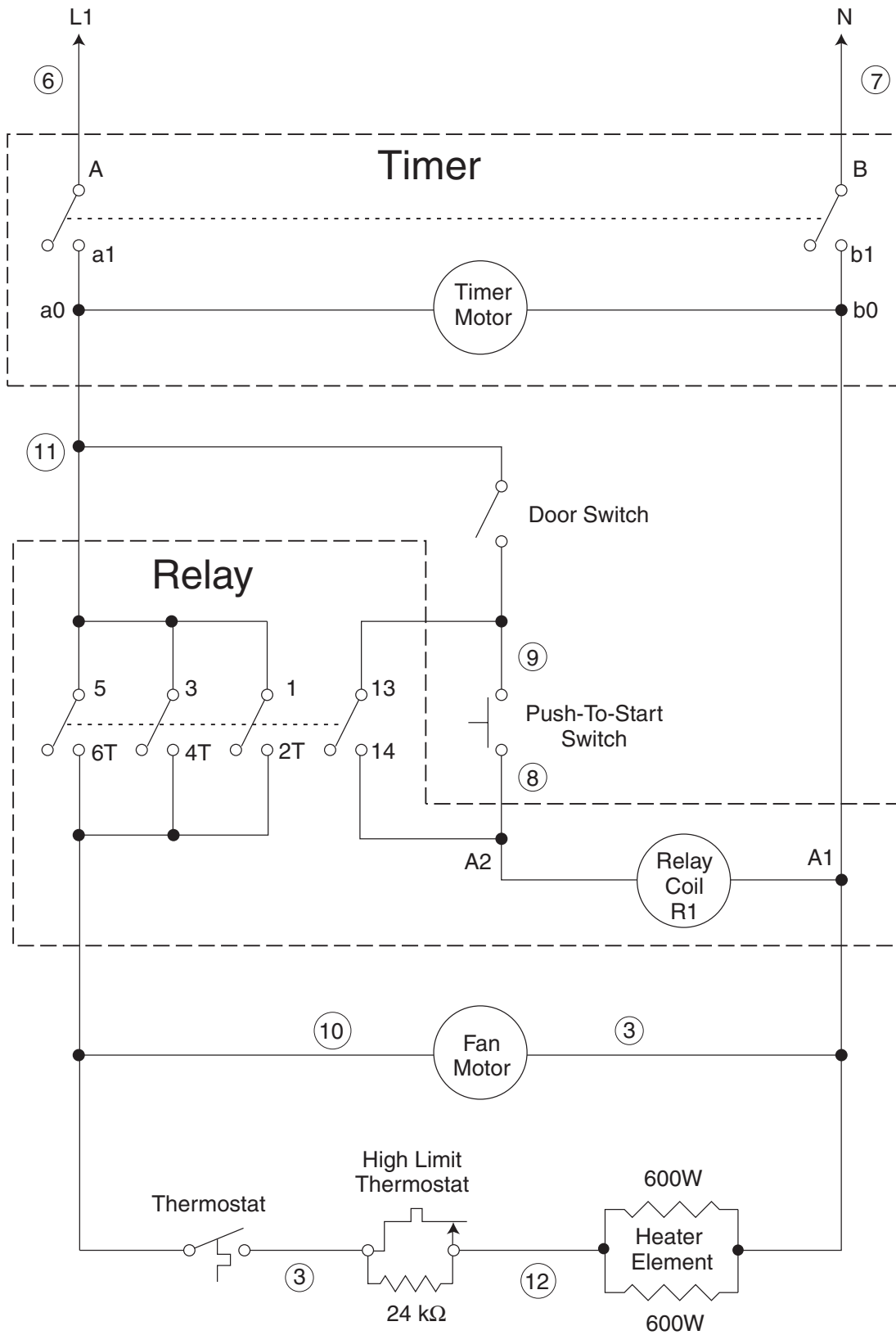

NOTE: (X) indicates wire number.

— NOTES —

PRODUCT SPECIFICATIONS AND WARRANTY INFORMATION SOURCES

IN THE UNITED STATES:

FOR PRODUCT SPECIFICATIONS AND WARRANTY INFORMATION CALL:

FOR WHIRLPOOL PRODUCTS: 1-800-253-1301
FOR KITCHENAID PRODUCTS: 1-800-422-1230
FOR ROPER PRODUCTS: 1-800-447-6737

FOR TECHNICAL ASSISTANCE WHILE AT THE CUSTOMER'S HOME CALL:

THE TECHNICAL ASSISTANCE LINE: 1-800-253-2870

**HAVE YOUR STORE NUMBER READY TO IDENTIFY YOU AS AN
AUTHORIZED SERVICER**

FOR LITERATURE ORDERS:

PHONE: 1-800-851-4605

IN CANADA:

FOR PRODUCT SPECIFICATIONS AND WARRANTY INFORMATION CALL:

1-800-461-5681

FOR TECHNICAL ASSISTANCE WHILE AT THE CUSTOMER'S HOME CALL:

THE TECHNICAL ASSISTANCE LINE: 1-800-488-4791

**HAVE YOUR STORE NUMBER READY TO IDENTIFY YOU AS AN
AUTHORIZED SERVICER**

