



ELECTROLUX MAJOR APPLIANCES OF NORTH AMERICA

SERVICE MANUAL

5.75 Cu. Ft. Dryer

Gas & Electric

6000 and 7000

Models

Frigidaire

TAPPAN

W White-Westinghouse

Gibson

Kelvinator 

SAFE SERVICING PRACTICES - ALL APPLIANCES

To avoid personal injury and/or property damage, it is important that **Safe Servicing Practices** be observed. The following are some limited examples of safe practices:

1. **DO NOT** attempt a product repair if you have any doubts as to your ability to complete it in a safe and satisfactory manner.
2. Before servicing or moving an appliance:
 - Remove the power cord from the electrical outlet, trip the circuit breaker to the OFF position, or remove the fuse.
 - Turn off the gas supply.
 - Turn off the water supply.
3. Never interfere with the proper operation of any safety device.
4. **USE ONLY REPLACEMENT PARTS CATALOGED FOR THIS APPLIANCE. SUBSTITUTIONS MAY DEFEAT COMPLIANCE WITH SAFETY STANDARDS SET FOR HOME APPLIANCES.**
5. **GROUNDING:** The standard color coding for safety ground wires is **GREEN**, or **GREEN** with **YELLOW STRIPES**. Ground leads are not to be used as current carrying conductors. It is **EXTREMELY** important that the service technician reestablish all safety grounds prior to completion of service. Failure to do so will create a hazard.
6. Prior to returning the product to service, ensure that:
 - All electrical connections are correct and secure
 - All electrical leads are properly dressed and secured away from sharp edges, high-temperature components, and moving parts
 - All non-insulated electrical terminals, connectors, heaters, etc. are adequately spaced away from all metal parts and panels
 - All safety grounds (both internal and external) are correctly and securely connected
 - All panels are properly and securely reassembled

ATTENTION!!!

This service manual is intended for use by persons having electrical and mechanical training and a level of knowledge of these subjects generally considered acceptable in the appliance repair trade. Electrolux Home Products cannot be responsible, nor assume any liability, for injury or damage of any kind arising from the use of this manual.

SAFE SERVICING PRACTICES	2
QUICK REFERENCE SHEET	7
Serial nameplate location	7
Serial number breakdown	7
Tech sheet location	7
Function test sequence	8
Specification	9
Component resistance chart	10
Sample wiring diagram for electric models	11
Sample wiring diagram for gas models	12
SECTION A - OPERATING INSTRUCTIONS	13
Before operating your dryer	13
Operating Steps	13
Cycle Selection	13
Auto Dry	13
Towels	14
Heavy Duty	14
Normal	14
Perm Press	14
Delicates	14
Touch Up	14
Timed Dry	14
Cycle Settings	14
Drying Temperature	14
Dryness Level	14
Options	15
Dryer Features	15
Control Lock	15
Start/Pause	15
Cancel	15
Status Lights	15
Error Code Chart	16
Dryer Setting Chart	17
SECTION B - OWNERS GUIDE	18
Product Registration	18
Safety Information	18
What To Do If You Smell Gas	18
Your Safety And The Safety Of Other Is Very Important	18
Pedestal	19
Important Safety Instructions	19
Prevent Fire	19
Protect Children	19
Prevent Injury	19
Drying Procedures	21
Features	22
End Of Cycle Signal	22
Drum Light	22
Reversible Dryer Door	22
Drying Rack	22
Common Drying Problems	23
Care And cleaning	24
Inside	24
Outside	24
Avoid Service Checklist	25
Sample Warranty	27
SECTION C - INSTALLATION INSTRUCTIONS GAS & ELECTRIC DRYER	28

What To Do If You Smell Gas	28
Pre-installation Requirements	29
Tools And Materials Required For Installation	29
Electrical Requirements	29
Electric Dryers	29
Gas Dryers	29
Exhaust System Requirements	29
Exhaust Directions	31
Exhaust Duct Locating Dimensions	31
Location Of Your Dryer	31
Do Not Install Your Dryer	31
Installation In A Recess Or Closet	31
Minimum Installation Clearances	32
This Dryer Must Be Exhausted Outdoors	32
Dryer Installation Dimensions	33
Mobile Home Installation	34
Unpacking	34
Reversing Door Swing	34
Electrical Installation	36
Electric Dryers	36
Grounding Requirements Non Canadian Electric Dryers	36
For A Grounded, Cord-connected Dryer	36
For A Permanently Connected Dryer	36
Canadian Electric Dryer	36
All Gas Dryer	37
Electrical Connections For 3-wire System Non Canadian Electric Dryers	37
Electrical Connections For 4-wire System Non Canadian Electric Dryers	37
Gas Connection	38
General Installation	38
Replacement Parts	39
SECTION D - Pedestal Installation Instructions	40
Washer Installation	40
Dryer Installation	42
Warranty	44
SECTION E - HOW THE COMPONENTS WORK	45
The Basic Components	45
Drum	45
Heat Source	45
Electric	45
Gas	45
Drive Motor And Blower	45
Control Thermistor	46
Electronic Control Board	46
Airflow	46
Airflow Electric Dryers	46
Airflow Gas Dryers	47
Airflow Problems	47
Restrictions	48
Air Leaks	48
Short Unrestricted Vents	48
Electrical Operation (Electric Dryers Models)	48
Electronic Control Board Circuits	48
Drive Motor Circuit	49
Temperature Sensing Circuit	49
The Heating Circuit	49
Drying Time	50

Electrical Operation (Gas Dryers Models)	50
Electronic Control Board Circuits	50
Drive Motor Circuit	51
Temperature Sensing Circuit	51
The Heating Circuit	51
Drying Time	52
SECTION F - TROUBLESHOOTING	53
Reading Error Codes	53
Failure Code Chart	53
Troubleshooting Flow Charts Index	55
Electric Dryer Completely Inoperative	56
Gas Dryer Completely Inoperative	57
Electric And Gas Dryers; Blower Motor Runs But Drum Does Not Turn	58
Electric And Gas Dryers; Longer Than Normal Drying Times	56
Electric Dryer Not Heating Properly	59
Gas Dryer Not Heating Properly	60
Electric and Gas Dryers; Dryer Over Heating	60
Electric Dryers; Blower Motor Runs But Dryer Does Not Heat	61
Gas Dryers; Blower Motor Runs But Dryer Does Not Heat	62
Electric And Gas Dryers; Clothes Not Dry In Auto Cycle	63
Electric And Gas Dryers; Selector LEDs Do Not Light.	64
SECTION G - TEARDOWN	65
Removing The Top Panel	65
Removing The Console	65
Removing The Control Board	66
Removing The Control Board's Rear Cover	66
Removing The Interface Board	66
Removing The Selector Knob	66
Removing The Button Spring	67
Removing The Buttons	67
Removing The Loading Door	67
Disassembling The Loading Door	68
Removing The Catch Plate	69
Removing The Catch	69
Removing The Door Switch	70
Removing The Front Panel	70
Replacing The Sensor Bars	71
Replacing The Front Panel Air Duct	71
Replacing The Drum Light Bulb	72
Replacing The Drum Light Housing	72
Replacing The Drum Light Socket	72
Replacing The Felt Seal	72
Replacing The Foam Seal	72
Removing The Rear Access Panel	73
Releasing The Dryer Belt	73
Removing The Vane From The Drum	73
Removing The Drum	73
Removing The Belt	74
Removing The Hitch Ball From The Drum	74
Removing The Teflon Glides	74
Removing The Drum Heat Shield (Electric Dryers)	74
Removing The Hitch	75
Removing The High Limit Thermostat	75
Removing The Thermal Limiter (Electric Dryers)	75
Removing The Heating Element Assembly (Electric Dryers)	75

Removing The Control Thermistor _____	76
Removing The Blower Housing And Fan Blade _____	76
Removing The Idler Pulley _____	77
Removing The Idler Pulley Assembly _____	77
Removing The Drive Motor _____	77
Removing The Burner (Gas Dryers) _____	78
Removing The Ignitor (Gas Dryers) _____	78
Removing The Gas Valve Assembly (Gas Dryers) _____	78
Removing The Gas Valve Coils (Gas Dryers) _____	79
Removing The Sensor (Gas Dryers) _____	79
Removing The Combustion Chamber (Gas Dryers) _____	79
Removing The Duct And Heat Shield (Gas Dryers) _____	80
Removing The Manifold Pipe (Gas Dryers) _____	80
Removing The Vent Pipe (Gas Dryers) _____	81
Removing The Gasket Between The Vent Pipe And Blower Housing _____	81

QUICK REFERENCE SHEET

1. Serial nameplate location: on the front panel at the left side of the dryer door opening.



2. Serial number breakdown.

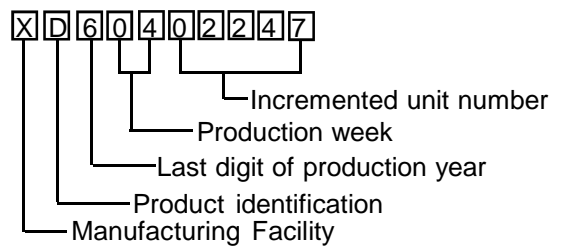

3. Tech sheet location:

On the right-hand bodyside behind the front panel and inside rear access panel.

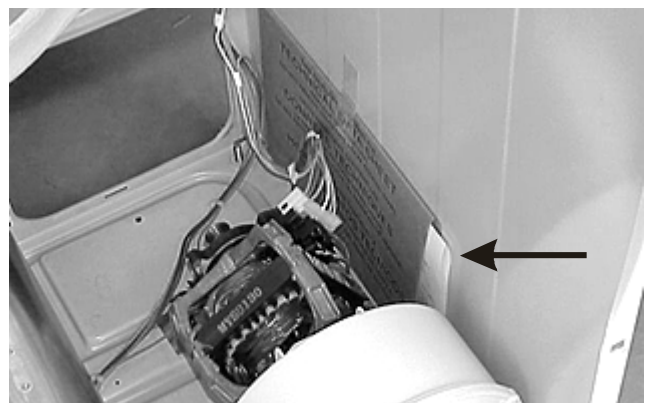

FUNCTION TEST SEQUENCE

1. Press and hold **Select** and **Cancel** buttons simultaneously for 6 seconds to reset the control. The buzzer will sound 1 time and “*rES*” will be shown briefly in the display.
2. Immediately after, rotate cycle selector knob 5 turns counterclockwise to the second position from the bottom. Press and hold the **Options** and **Cancel** buttons simultaneously for 2 seconds. The control will enter test mode, the buzzer will sound 3 times and all LED’s will rapidly flash.

After entering the test mode, the cycle selector knob can now be rotated to select the following tests:

Rotate the cycle selector knob clockwise from the starting position:

- 0 turns: All LED’s will flash.
- 1 turn: Drive motor runs; heat source is on. **Drying** LED is lit. “*H*” and the control thermistor reading will toggle back and forth in the display.
- 2 turns: Drive motor runs; heat source is off. **Cool Down** LED is lit and “*AF*” (Air Fluff) is displayed.
- 3 turns: Drive motor runs; heat source is off. **Drying** and **Cool Down** LED’s are lit and numbers appear in the display showing moisture sensor readings. Opening the door (press in on door switch plunger) and placing a finger on the both moisture sense bars at the same time will make the numbers decrease. In controls that do not have a digit display, the **More Dry** LED should be ON. Opening the door (press in on door switch plunger) and placing a finger on the both moisture sense bars at the same time will make the **Damp** LED come on.
- 4 turns: Drive motor runs; heat source is off.
Key test:
a. When the **Temperature** key is pressed, all the temperature LED’s should light.
b. When the **Dryness** key is pressed, all the dryness level LED’s should light.
c. When the **Options** or **Select** key is pressed, all the Option LED’s should light.
d. When the **Start/Pause** key is pressed, all the cycle status LED’s should light.
e. When the **Cancel** key is pressed, all the cycle status LED’s should light.
- 5 turns: Drive motor runs; heat source is off. **Cool Down** LED is lit. Control thermistor reading is displayed.
- 6 turns: Drive motor runs; heat source is on. **Drying** LED is lit. Control thermistor reading is displayed.
- 7-11 turns: All LED’s will flash.

To **EXIT** test mode, press and hold the **Select** and **Cancel** buttons simultaneously for 6 seconds or disconnect power from dryer. Dryer will be reset for regular operation.

QUICK REFERENCE SHEET

SPECIFICATION	ELECTRIC MODELS	GAS MODELS
Electrical		
Volts 120/208 or 120/240	120/208 or 120/240	120
Amps (circuit)	30	15
Motor wattage	160-350 Watts	160-350 Watts
Heat input (Watts @ 240 VAC)	3200/4500	---
Heat input (BTU/Hr.)	---	20,000
Auto. Elec. Ignition	---	Yes
Drum		
Size (Cu. Ft.)	5.75	5.75
Finish	Powder Paint Epoxy	Powder Paint Epoxy
R.P.M.	48 - 54	48 - 54
Airflow CFM	200	200
DRUM TEMPERATURES (Max. opening on 1st cycle)		
Maximum	138° - 190°	145° - 190°
High	134° - 180°	140° - 180°
Medium	130° - 170°	130° - 170°
Low	120° - 165°	120° - 165°
Dimension (Inches)		
Height	36"	36"
Width	27"	27"
Depth	28.5"	28.5"
Vent Capability**	4-Way	3-Way
Top Finish	Powder Paint Enamel	Powder Paint Enamel
Port Opening (Sq. In.)	235	235

** Electric dryers can be vented four ways: through back, bottom, right or left side.

** Gas dryers can be vented three ways: through back, bottom, or right side.

QUICK REFERENCE SHEET

Component Resistances*	Electric Models	Gas Models
Drive motor (120 volt, 60 Hz, 1/4 h.p. 1725 rpm)		
Motor Start Winding	4.5 Ohms	4.5 Ohms
Motor Run Winding	3.8 Ohms	3.8 Ohms
Heating Element	12.8 Ohms	
Control Thermistor	50K Ohms +/- 5% @ 77° F	50K Ohms +/- 5% @ 77° F
Burner Assembly		
Ignitor	---	50 - 400 Ohms
Secondary Coil	---	1200 Ohms
Booster Coil	---	1320 Ohms

* +/- 10% @ 77° F

SAMPLE WIRING DIAGRAM FOR ELECTRIC MODELS

CAUTION: DISCONNECT ELECTRIC CURRENT BEFORE SERVICING. LABEL ALL WIRES PRIOR TO DISCONNECTION WHEN SERVICING CONTROLS. WIRING ERRORS CAN CAUSE IMPROPER AND DANGEROUS OPERATION. VERIFY PROPER OPERATION AFTER SERVICING.

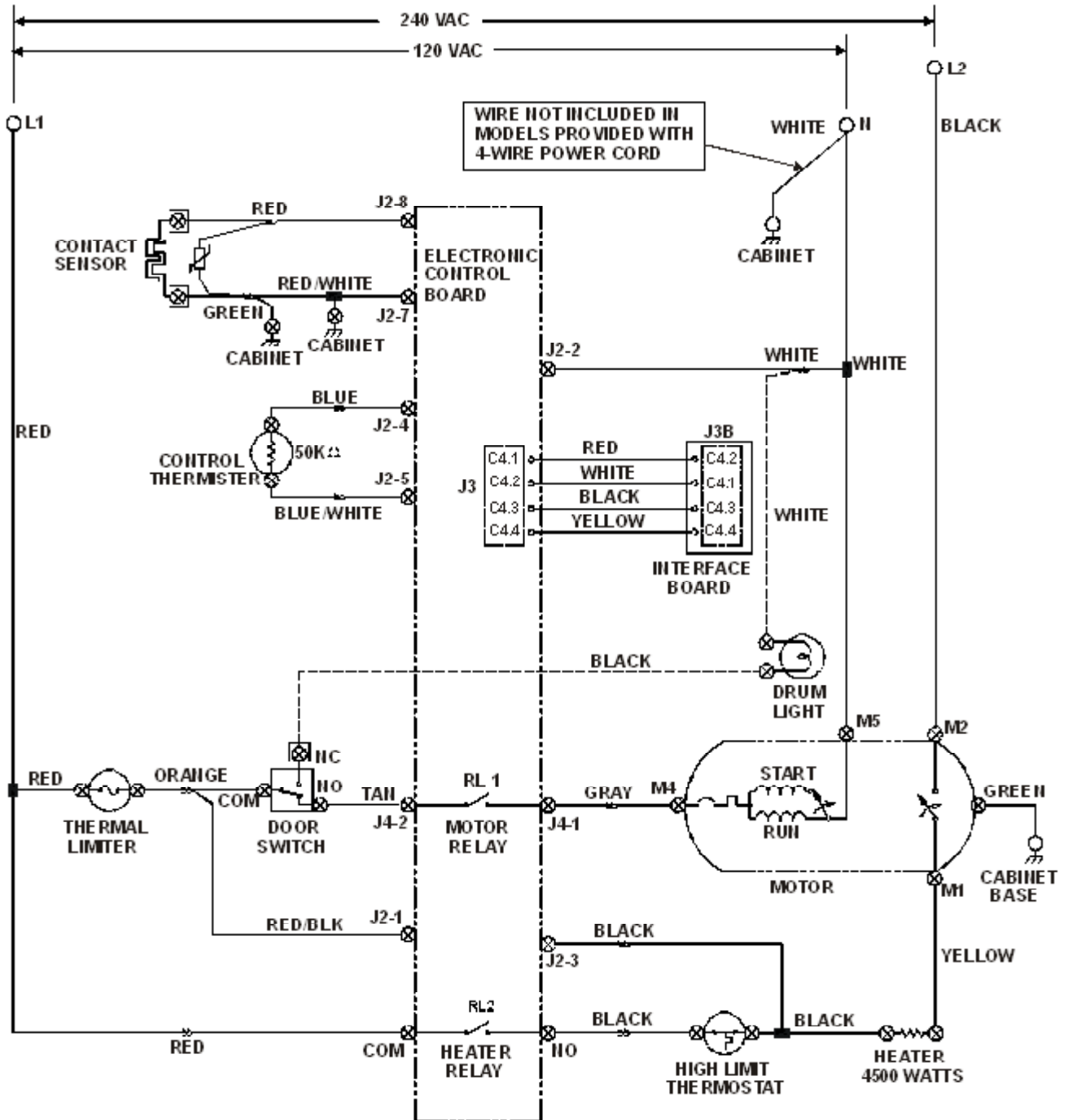

WIRING CODES	
	QUICK DISCONNECT TERMINALS
	CONNECTION
	NO CONNECTION
	MOTOR SWITCH
	SPLICE
	MOTOR PROTECTOR
	CHASSIS (CABINET) GROUND
	SCREW TERMINAL
	HARNESS CONNECTOR TERMINAL
	INSULATED TERMINAL
	TRANSIENT VOLT SUPPRESSOR

NOTES:

1. ALL WIRING MUST CONFORM TO LOCAL ELECTRICAL CODES.
2. CONNECT DRYER TO A 30 AMPERE INDIVIDUAL BRANCH CIRCUIT.
3. CONTROL SHOWN IN THE OFF POSITION, DOOR SWITCH CLOSED & MOTOR AT REST.

NOTE: DASHED LINES INDICATE CIRCUITS THAT ARE NOT IN ALL MODELS

SAMPLE WIRING DIAGRAM FOR GAS MODELS

CAUTION: DISCONNECT ELECTRIC CURRENT BEFORE SERVICING. LABEL ALL WIRES PRIOR TO DISCONNECTION WHEN SERVICING CONTROLS. WIRING ERRORS CAN CAUSE IMPROPER AND DANGEROUS OPERATION. VERIFY PROPER OPERATION AFTER SERVICING.

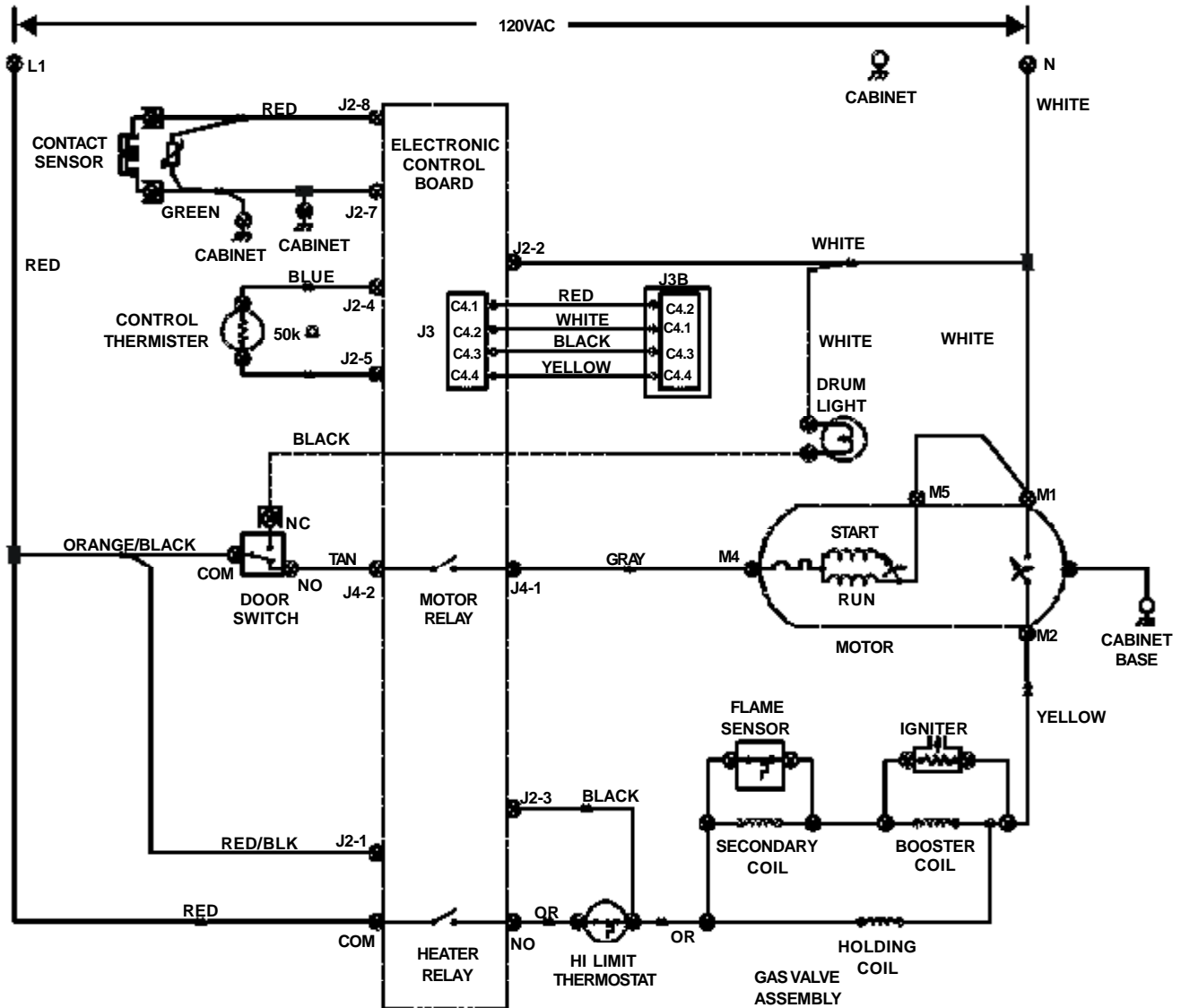

WIRING CODES	
	QUICK DISCONNECT TERMINALS
	CONNECTION
	NO CONNECTION
	MOTOR SWITCH
	SPLICE
	MOTOR PROTECTOR
	CHASSIS (CABINET) GROUND
	SCREW TERMINAL
	HARNESS CONNECTOR TERMINAL
	INSULATED TERMINAL
	TRANSIENT VOLT SUPPRESSOR

NOTES:

1. ALL WIRING MUST CONFORM TO LOCAL ELECTRICAL CODES.
2. CONNECT DRYER TO A 30 AMPERE INDIVIDUAL BRANCH CIRCUIT.
3. CONTROL SHOWN IN THE OFF POSITION, DOOR SWITCH CLOSED & MOTOR AT REST.

NOTE: DASHED LINES INDICATE CIRCUITS THAT ARE NOT IN ALL MODELS

SECTION A - OPERATING INSTRUCTIONS

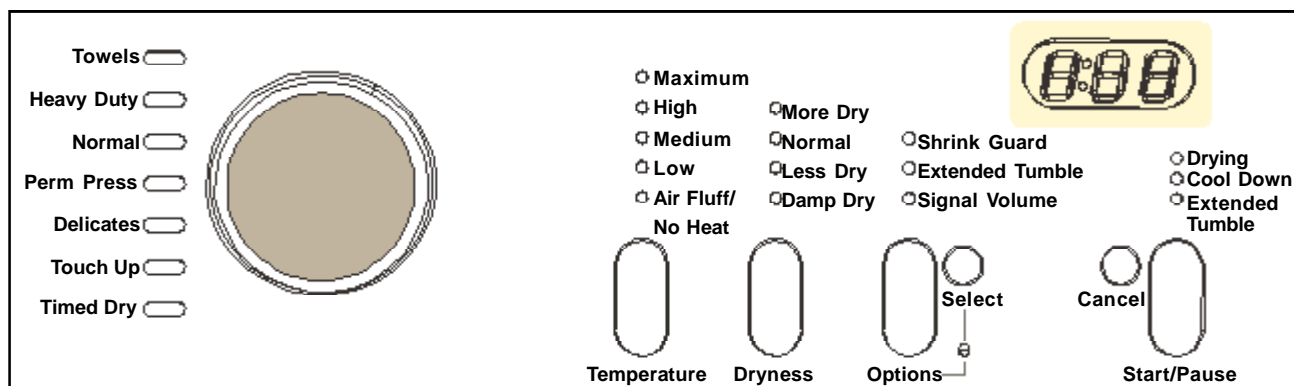

Before Operating Your Dryer

Read your dryer Use and Care Guide. It has important safety and warranty information. It also has many suggestions for best drying results.

⚠ WARNING To reduce the risk of fire, electric shock or injury to persons, read the IMPORTANT SAFETY INSTRUCTIONS in your dryer Use and Care Guide before operating this appliance.

Operating Steps

Read “Drying Procedures” in your Owners Guide. It explains these operating steps in detail.

1. Prepare items for drying.
2. Check that lint screen is clean and in place.
3. Load the dryer. If desired, add a dryer fabric softener sheet. Close the door.
4. Select the appropriate cycle and settings for each load.
 - Turn the Cycle Selector knob to select the cycle. The estimated drying time will be displayed.
 - A suitable drying temperature, dryness level and options will automatically be indicated for each cycle. See the “Dryer Setting Chart” for more details.
 - To change the temperature and dryness level, press Temperature or Dryness until the desired selections are made.
 - To select or delete an option, press Options; then, while the indicator is blinking, press Select. The indicator will light when the option has been selected. It will no longer be lighted when the

option has been deleted.

- If a temperature, dryness level or option is not available for a cycle, it will not light.
- Adjustments to the cycle will be remembered each time that cycle is selected in the future.
- To return to factory settings, press Start/Pause and Select at the same time and hold until the signal sounds.

5. Press Start/Pause to begin the cycle.

- To pause the cycle press Start/Pause. To resume the cycle, press Start/Pause again.
- To stop or change the cycle, press Cancel.

6. A signal will sound at the end of the cycle and periodically during Extended Tumble when the Signal option is selected. When the cycle ends, remove items immediately and hang or fold.

7. Clean the lint screen after every load.

Cycle Selection

Turn the Cycle Selector knob to the desired cycle. For best results, follow the fabric care label instructions on items to be dried. If the selection is changed after the cycle starts, the indicator lights will blink, the signal will beep and “ERR” will be displayed. To change the selection after the cycle has begun, press Cancel before making another choice. Just turning the knob to another selection will not change the cycle. The signal will beep and the status lights will flash, but the original cycle will continue.

Auto Dry

Auto Dry cycles take the guesswork out of drying time. Loads dried using the Towels, Heavy Duty, Normal, Perm Press, and Delicates cycles will dry automatically at

the selected temperature to the desired dryness level.

The dryer uses sensing bars to sense the moisture level of the load as it tumbles through heated air. Auto Dry cycles save time and energy and protect fabrics.

The estimated drying time will be displayed for about 5 minutes. Then the display will change to “Ad” to indicate drying time is automatically being determined by the sensors. When the load has reached the selected dryness level, it will continue to tumble, unheated, during a Cool Down period. This helps reduce wrinkling and makes items easier to handle during unloading. The estimated Cool Down time will be displayed.

Drying time varies depending on size and dampness of load and fabric type. If the load is too small or almost dry, the sensing bars may not detect enough moisture to continue the cycle and the cycle may end after a few minutes. Select a Timed Dry setting to dry such loads.

Room temperature and humidity, type of installation and electrical voltage or gas pressure can also affect drying time.

Towels

Select this Auto Dry cycle for towel loads.

Heavy Duty

Select this Auto Dry cycle for sturdy work clothes.

Normal

Select this Auto Dry cycle for cotton items.

Perm Press

Select this Auto Dry cycle to dry cotton items and blends with a no-iron finish.

Delicates

Select this Auto Dry cycle for knit and delicate items.

Touch Up

Select Touch Up to help remove wrinkles from clean dry items that may have been left in the dryer, have been stored in crowded closets or drawers or unpacked from luggage following a trip. The load will tumble for 15 minutes at low heat.

Timed Dry

To manually select the drying time for any load, turn the knob to Timed Dry. Drying times from 15 to 90 minutes can be selected by continuing to turn the knob. Drying time will be displayed. You will not be able to select a dryness level. Timed Dry is recommended when using the Air Fluff/No Heat setting. **Note:** To change cycles, press Cancel.

⚠ WARNING To avoid fire hazard, do not use heat to dry items containing feathers or down, foam rubber, plastic, or similarly textured, rubber-like materials. Use the Air Fluff/No Heat setting only.

Cycle Settings

Appropriate drying Temperature, Dryness Level and Options will automatically be displayed for each cycle. The settings can be changed before the cycle is started. Those adjustments will automatically be remembered each time that cycle is selected. If a temperature, dryness level or option is not recommended for a cycle, the indicator will not light.

If changes are attempted after the cycle starts, the lights will blink, the signal will beep and “Err” will be displayed. To change a setting after the cycle starts, press Start/Pause, adjust the setting and press Start/Pause to resume the cycle. See the “Dryer Settings Chart” for more details.

Drying Temperature

For best results, follow the fabric care label instructions on items to be dried. To change the drying temperature, press Temperature to scroll to the desired heat. To protect your wardrobe, not all temperatures are available with every cycle.

Maximum heat is recommended for sturdy fabrics.

High heat is recommended for most cotton fabrics.

Medium heat is recommended for wrinkle free, permanent press and lightweight fabrics.

Low heat is recommended for delicate fabrics.

Air Fluff/No Heat should only be used with a Timed Dry setting to dry items containing feathers, down, foam rubber, plastics or rubber-like materials; to freshen clothing, pillows or blankets; or to dust draperies.

Note: Using Air Fluff/No Heat in any Auto Dry cycle will result in long drying times and /or wet loads at the end of the cycle.

Dryness Level

To change the dryness level, press Dryness until the desired selection is made. Select **Normal** for most loads.

Occasionally a load may seem too damp or over-dried at the end of the cycle. To increase drying time for similar loads in the future, select **More Dry**. For loads requiring less drying time, select **Less Dry**.

Select **Damp Dry** for items you wish to partially dry before hanging or ironing.

<p>Note: To prevent over-drying, not every dryness level is available with every cycle.</p>
--

Status Lights

The following indicators may be lighted during the cycle:

- Drying
- Cool Down
- Extended Tumble

Options

To select an option, press Options until the indicator for the desired option flashes, then press Select. If an option is not available for a cycle, the indicator will not light. Follow the same steps to delete an option.

A **Signal** will sound at the end of the cycle and periodically during Extended Tumble. The signal has an adjustable volume level or can be turned off.

Select **Shrink Guard** to lower the initial drying temperature to protect fabrics from overdrying.

Select **Extended Tumble** if the dried load might not be removed promptly at the end of the cycle. The dry load will continue tumbling without heat for 30 minutes to help reduce wrinkling. When the Signal is selected, a beep will be heard periodically. The load may be removed any time during Extended Tumble.

Dryer Features

Control Lock

To avoid having someone accidentally start or stop the dryer, press Options and Select at the same time and hold for 10 seconds. "**LOC**" will be displayed. To remove the control lock, press Options and Select again.

Start/Pause

Press Start/Pause to start, pause or restart a cycle. "**PAU**" will be displayed alternately with the estimated time remaining when the cycle is paused.

Cancel

Press Cancel to stop the cycle.

ERROR CODE CHART

If the dryer stops, the status lights flash, the signal beeps and a code is displayed, an error has occurred. Press CANCEL. Consult the Error Code Chart below or the "Avoid Service Checklist" in the Owner's Guide for the possible cause and solution. Make necessary corrections, then select a cycle and press START. If the dryer stops, the status lights flash again, the beeping continues and the code reappears, please contact service for assistance.

Error Code	Error	Possible Causes	Solutions
4 beeps/E4A	Dryer runs to long	Lint filter blocked. Ventilation system clogged. Dryer overloaded.	Remove lint; wash lint filter to remove the softener sheet residue. Clean out ventilation system. Reduce load size.
9 beeps/E9E	Line voltage problem.	Low voltage. Intermittent voltage.	Press Cancel.
6 beeps/E68	Push button does not function.	Pushbutton held too long or wedged in the control panel.	Press buttons lightly and release. Disengage button.

DRYER SETTINGS CHART

AVAILABLE CYCLE SETTINGS - These temperatures, dryness levels and options are available with the following cycles:

	Towels	Heavy Duty	Normal	Perm Press	Delicate	Touch Up	Timed Dry
Estimated Drying Time	60 minutes	45 minutes	50 minutes	40 minutes	20 minutes	15 minutes	15 to 90 minutes

Temperatures

Maximum	X	*X	*X				X
High	X	X	X	X			*X
Medium		X	X	*X	X		X
Low		X	X	X	*X	*X	X
Air Fluff/ No Heat							X

Dryness Level

More Dry	*X	X	X				
Normal Dry	X	*X	*X	*X	X		
Less Dry		X	X	X	*X		
Damp Dry		X	X	X	X		

Options

Shrink Guard		X	X	X	*X		X
Extended Tumble		X	X	*X	*X	X	X
Signal Volume	*X	*X	*X	*X	*X	*X	*X

*Factory setting

X Available settings

**Estimated cycle duration is based on normal dryness level and factory settings.

SECTION B - OWNERS GUIDE

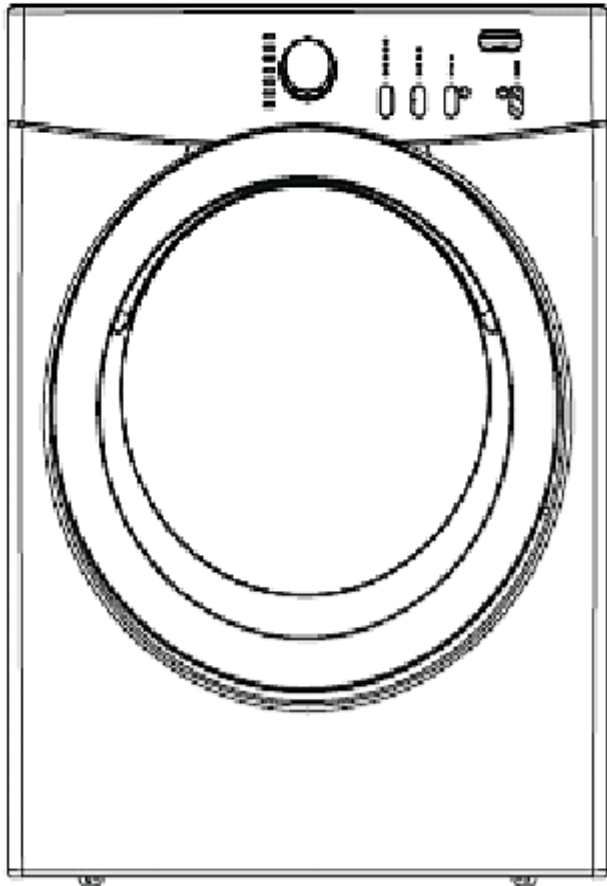

Product Registration

Thank you for choosing this dryer. This owner's guide will explain proper operation and care.

Register Your Product

The self-addressed **PRODUCT REGISTRATION CARD** should be filled in completely, signed and returned.

Record Your Model and Serial Numbers

Record below the model and serial numbers found on the dryer serial plate located on the left side of the door opening. Keep these numbers for future reference.

Model Number: _____

Serial Number: _____

Purchase Date: _____

Read and Save These Instructions

⚠ WARNING For your safety, the information in this

manual must be followed to minimize the risk of fire or explosion or to prevent property damage, personal injury or loss of life.

- Do not store or use gasoline or other flammable vapors and liquids in the vicinity of this or any other appliance.
- **WHAT TO DO IF YOU SMELL GAS:**
 - Do not try to light any appliance.
 - Do not touch any electrical switch; do not use any phone in your building.
 - Clear the room, building or area of all occupants.
 - Immediately call your gas supplier from a neighbor's phone. Follow the gas supplier's instructions.
 - If you cannot reach your gas supplier, call the fire department.

Installation and service must be performed by a qualified installer, service agency or the gas supplier.

This Use and Care Guide provides general operating instructions for your dryer. It also contains information about features for several other models. Your dryer may not have every feature included.

Use the dryer only as instructed in this Use & Care Guide and the Operating Instructions included with your dryer.

Your safety and the safety of others is very important.

We have provided many important safety messages in the Use and Care Guide, Operating Instructions, Installation Instructions and on your appliance. Always read and obey all safety messages.

⚠ This is the safety alert symbol. This symbol alerts you to hazards that can kill or hurt you or others. All safety messages will be preceded by the safety alert symbol and the word "DANGER" or "WARNING". These words mean:

⚠ DANGER You will be killed or seriously injured if you don't follow instructions.

⚠ WARNING You can be killed or seriously injured if you don't follow instructions.

All safety messages will identify the hazard, tell you how to reduce the chance of injury, and tell

you what can happen if the instructions are not followed.

Pedestal

A pedestal accessory, **Model No. APWD15W**, specifically designed for this dryer may be used when elevating the dryer for ease of use.

Failure to use accessories certified by the manufacturer could result in personal injury, property damage or damage to the dryer.

Important Safety Instructions

SAVE THESE INSTRUCTIONS

Read all instructions before using this dryer.

⚠ WARNING To reduce the risk of fire, electrical shock, or injury to persons when using this dryer, comply with the basic warnings listed below.

Failure to comply with these warnings could result in serious personal injuries.

Prevent Fire

⚠ WARNING Do not dry items that have been previously cleaned in, soaked in, or spotted with gasoline, cleaning solvents, kerosene, waxes, etc. Do not store these items on or near the dryer. These substances give off vapors that could ignite or explode.

⚠ WARNING Do not place items exposed to cooking oils in your dryer. Items contaminated with cooking oils may contribute to a chemical reaction that could cause a load to catch fire.

⚠ WARNING To prevent fire, do not use heat to dry items containing plastic, foam rubber or similarly textured rubber-like materials, or items containing feathers or down. Use Air Fluff (No Heat) only.

⚠ WARNING Clean the lint screen before or after each load. The interior of the dryer, lint screen housing and exhaust duct should be cleaned approximately every 18 months by qualified service personnel. An excessive amount of lint buildup in these areas could result in inefficient drying and possible fire. See **Care and Cleaning**.

⚠ WARNING Do not operate the dryer if the lint screen is blocked, damaged or missing. Fire hazard, overheating and damage to fabrics can occur. If your dryer has a

drying rack, always replace the lint screen when finished using the drying rack.

⚠ WARNING Keep area around the exhaust opening and surrounding areas free from the accumulation of lint, dust and dirt.

⚠ WARNING Do not obstruct the flow of ventilating air. Do not stack or place laundry or throw rugs against the front or back of the dryer.

⚠ WARNING Do not spray any type of aerosol into, on or near dryer at any time.

⚠ WARNING Do not use fabric softeners or products to eliminate static unless recommended by the manufacturer of the fabric softener or product.

Failure to comply with these warnings could result in fire, explosion, serious bodily injury and/or damage to the rubber or plastic parts of the dryer.

Protect Children

⚠ WARNING Do not allow children to play on or in the dryer. Close supervision of children is necessary when the dryer is used near children. As children grow, teach them the proper, safe use of all appliances.

⚠ WARNING Destroy the carton, plastic bag and other packing materials after the dryer is unpacked. Children might use them for play. Cartons covered with rugs, bedspreads or plastic sheets can become airtight chambers.

⚠ WARNING Keep laundry products out of children's reach. To prevent personal injury, observe all warnings on product labels.

⚠ WARNING Before the dryer is removed from service or discarded, remove the dryer door to prevent accidental entrapment.

Failure to comply with these warnings could result in serious personal injuries.

Prevent Injury

⚠ WARNING To prevent shock hazard and assure stability during operation, the dryer must be installed and electrically grounded by a qualified service person in accordance with local codes. Installation instructions

are packed in the dryer for the installer's reference. Refer to INSTALLATION INSTRUCTIONS for detailed grounding procedures. If the dryer is moved to a new location, have it checked and reinstalled by a qualified service person.

⚠ WARNING To prevent personal injury or damage to the dryer, the electrical power cord of a gas dryer must be plugged into a properly grounded and polarized 3-prong outlet. **The third grounding prong must never be removed. Never ground the dryer to a gas pipe. Do not use an extension cord or an adaptor plug.**

⚠ WARNING **ALWAYS disconnect** the dryer from the electrical supply before attempting any service or cleaning. Failure to do so can result in electrical shock or injury.

⚠ WARNING Do not use any type spray cleanser when cleaning dryer interior. Hazardous fumes or electrical shock could occur.

⚠ WARNING To prevent injury, do not reach into the dryer if the drum is moving. Wait until the dryer has stopped completely before reaching into the drum.

⚠ WARNING To prevent injury and damage to the dryer:

- **All repairs and servicing must be performed by an authorized servicer** unless specifically recommended in this Owner's Guide. Use only authorized factory parts.
- **Do not** tamper with controls.
- **Do not** install or store the dryer where it will be exposed to the weather.

⚠ A thermal limiter switch automatically turns off the motor in the unlikely event of an overheated situation (electric dryers only). A service technician must replace the thermal limiter switch after correcting the fault.

⚠ Failure to comply with these warnings could result in serious personal injuries.

⚠ WARNING Avoid fire hazard or electrical shock. Do not use an adaptor plug or extension cord or remove grounding prong from electrical power cord. Failure to follow this warning can cause serious injury, fire or death.

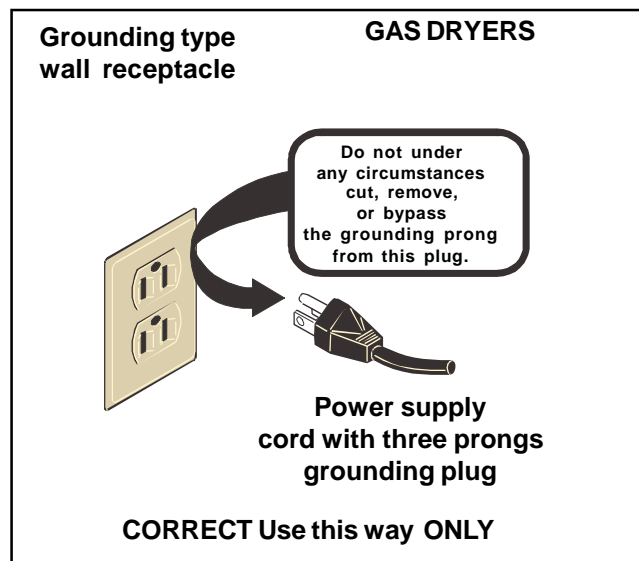
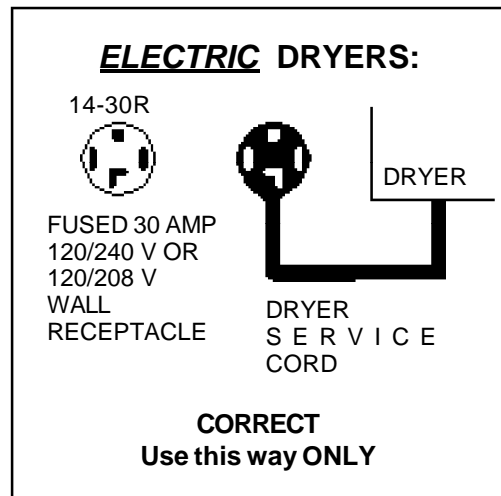

Note: The instructions appearing in this Owner's Guide are not meant to cover every possible condition and situation that may occur. Common sense and caution must be practiced when installing, operating and maintaining any appliance.

Drying Procedures

- Follow the guidelines below for preparing the load for drying.
- Read the **Operating Instructions** card for operating your specific model.
- **Always read and follow fabric care labels and laundry product labels.**

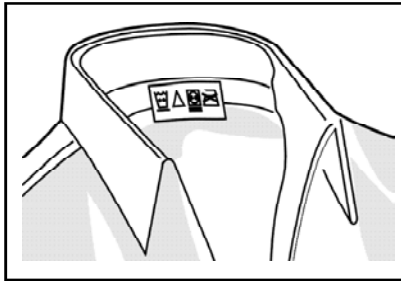

⚠ WARNING To reduce the risk of fire, electrical shock, or injury to persons, read **Important Safety Instructions** before operating this dryer.

1. Prepare items for drying.

- Dry items of similar fabric, weight and construction in the same load.
- Separate dark items from light-colored items. Separate items that shed lint from those that attract lint. If an item sheds lint, turn it inside out.
- Be sure buckles, buttons and trim are heatproof and won't damage the drum finish. Close zippers, fasten hooks and Velcro®-like fasteners. Tie strings and sashes to prevent snagging and tangling.
- If possible, turn pockets inside out for even drying.
- Check for stains which may not have been removed in washing. Dryer heat may permanently set some stains. Repeat stain removal process before drying.

- Place small items in a mesh bag to prevent tangling and for easy removal.

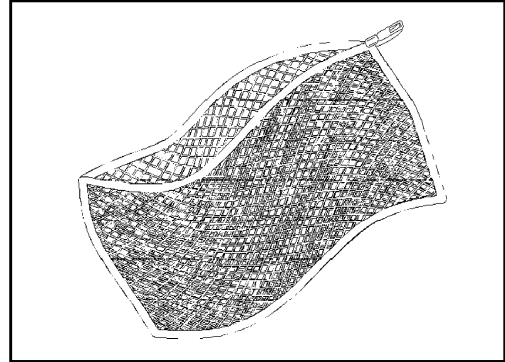

2. Check that lint screen is clean and in place.

3. Load the dryer.

- The average load will fill the drum 1/3 to 1/2 full. Items need room to tumble freely for even drying and less wrinkling. **Do not overload dryer.**

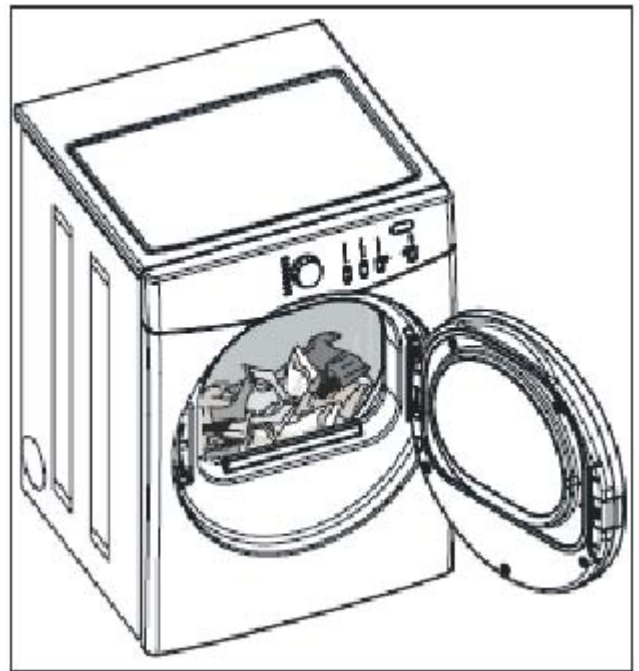

- When drying large items, dry only 2 or 3 at a time. Fill out the load with small and medium sized items.
- For delicate or very small loads, add 2 lint-free towels for better drying, less wrinkling, and to prevent grease stains caused by fabric softener sheets.
- Do not overdry items. Overdrying can cause wrinkling, shrinkage, harshness, and a buildup of static electricity, which can produce more lint.

- If desired, add a dryer fabric softener sheet.
4. Close the dryer door and select the cycle, temperature, dryness level and options desired.

See Operating Instructions card for your specific model information.

5. Press START to begin the cycle.
 - To add or remove items when the dryer is running open the door. The dryer will stop when the door is opened. Allow the drum to come to a complete stop before reaching inside.
 - Close the door and press START to resume the cycle.
6. When the cycle ends, remove items immediately and hang or fold.

Features

End of Cycle Signal

A signal will sound at the end of the cycle and periodically during Press Saver at the volume level selected. (Some models)

Drum Light (some models)

A drum light will come on whenever the door is opened to illuminate the dryer drum during loading and unloading. Closing the door turns off the light.

Reversible Dryer Door

Your dryer is equipped with a reversible door. The door can be hinged on the right or left side. Refer to the INSTALLATION INSTRUCTIONS for directions on changing the door.

Drying Rack (some models)

Use the drying rack to dry items which should not be tumble dried.

1. Open the dryer door and remove the lint screen.
2. Insert drying rack into the dryer drum. Place the front bar under the lip of the lint screen opening.

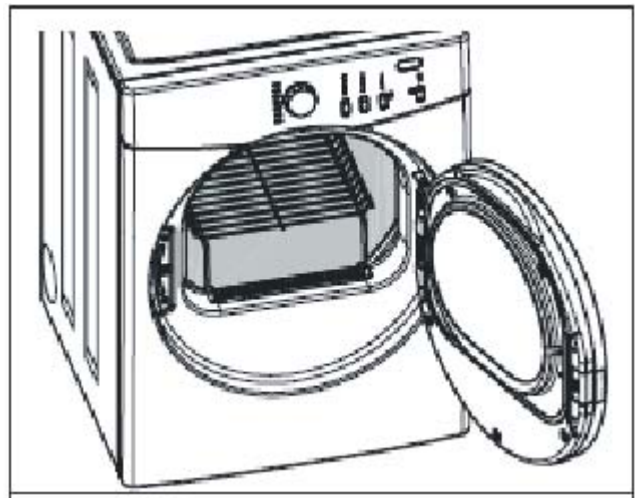

3. Place items to be dried on top of the rack. Weight should not exceed 10 lbs. Leave space between items, but do not let items hang over the sides or through the grids. Do not tumble other items when using the drying rack.
4. Select a timed dry. Use only the Air Fluff (no heat) temperature setting for items containing plastic, foam rubber, rubber-like materials, feathers or down.
5. When items are dry, remove the rack and replace the lint screen. If lint screen is not in place, tumbling items could enter the exhaust system and cause damage to the dryer.

Common Drying Problems

Many drying problems involve poor cleaning results, poor soil and stain removal, residues of lint and scum, and fabric damage. For satisfactory drying results, follow these suggestions provided by The Soap and Detergent Association.

PROBLEM	POSSIBLE CAUSES	SOLUTIONS	PREVENTIVE MEASURES
Greasy, oily stains	<ul style="list-style-type: none"> Fabric softener sheet. 	<ul style="list-style-type: none"> Rub fabric softener stains with bar soap. Rinse and rewash. 	<ul style="list-style-type: none"> Add a few bath towels to small loads for proper tumbling. Some "silk-like" fabrics should be air dried. Use proper drying temperature. Place fabric softener sheet on top of load before starting the dryer.
Lint	<ul style="list-style-type: none"> Overloading. Overdrying causes static electricity. Lint screen not clean when cycle began. Lint is attached to "pills." 	<ul style="list-style-type: none"> Reduce load size and rewash using liquid fabric softener in the final rinse. Or, add a fabric softener sheet and tumble without heat. Use lint brush or roller to remove lint. 	<ul style="list-style-type: none"> Do not overload dryer. Use fabric softener in washer or dryer to reduce static electricity. Remove items when they are slightly damp to avoid overdrying. Check that lint screen is clean and in place.
Pilling (Fibers break off, ball up and cling to fabric.)	<ul style="list-style-type: none"> Pilling is normal with synthetic and permanent press fabrics. This is due to abrasion from normal wear. 	<ul style="list-style-type: none"> Use a lint brush or shaver to remove pills. 	<ul style="list-style-type: none"> Use fabric softener to lubricate fibers. When ironing, use spray starch or fabric finish on collars and cuffs. Turn items inside out to reduce abrasion.
Shrinking	<ul style="list-style-type: none"> Overdrying. 	<ul style="list-style-type: none"> Irreversible condition. 	<ul style="list-style-type: none"> Follow fabric care label directions. If shrinking is a concern, check load often. Remove items while slightly damp and hang or lay flat to complete drying. Block knits into shape.
Wrinkling	<ul style="list-style-type: none"> Overloading. Leaving items in dryer after cycle ends. 	<ul style="list-style-type: none"> Reduce load size and tumble at medium or low heat for 5-10 minutes. Remove items immediately. Hang or fold. 	<ul style="list-style-type: none"> Do not overload dryer. Remove items as soon as cycle ends.

Care and Cleaning

⚠️ WARNING To reduce risk of fire or serious injury to persons or property, comply with the basic warnings listed in **Important Safety Instructions** and those listed below.

- Before cleaning the dryer interior, **unplug the electrical power cord** to avoid electrical shock hazards.
- Do not use any type spray cleanser when cleaning dryer interior. Hazardous fumes or electrical shock could occur.

Inside

- Clean the lint screen after every load. Lint buildup in the screen restricts air flow, which causes longer drying times. The screen is located at the bottom of the door opening. Remove by pulling straight up. Remove the lint and replace the screen.

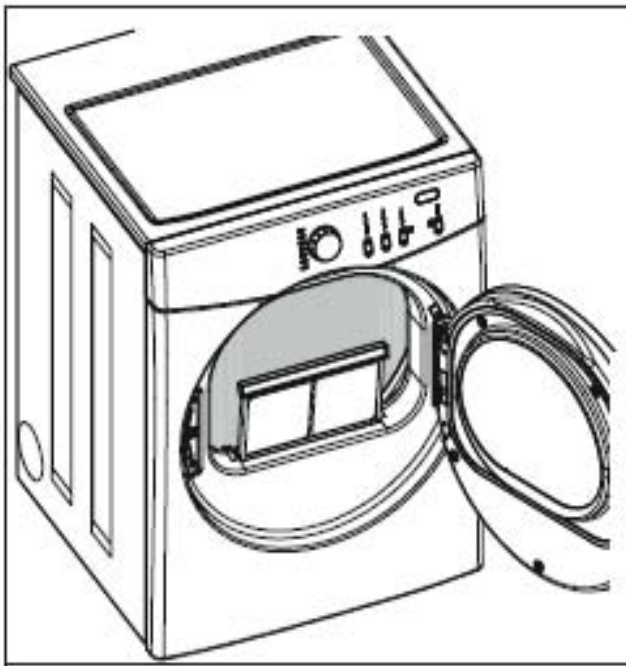

- Occasionally a waxy buildup may form on the lint screen from using dryer-added fabric softener sheets. To remove this buildup, wash the lint screen in warm, soapy water. Dry thoroughly and replace. Do not operate the dryer without the lint screen in place.
- If the dryer drum becomes stained from noncolorfast fabrics, clean the drum with a damp cloth and a mild liquid household cleanser. Remove cleanser residue before drying the next load.

- Every 18 months an authorized servicer should clean the dryer cabinet interior and exhaust duct. These areas can collect lint and dust over time. An excessive amount of lint buildup could result in inefficient drying and possible fire hazard.

Outside

- Clean the cabinet with mild soap and water. **Never use harsh, gritty or abrasive cleansers.**
- If the cabinet becomes stained, clean with diluted chlorine bleach [1/2 cup (120 ml) in 1 quart (.95 liter) water]. Rinse several times with clear water.
- Remove glue residue from tape or labels with a mixture of warm water and mild detergent. Or, touch residue with the sticky side of the tape or label.
- **Before moving the dryer**, place a strip of cardboard or thin fiberboard under the front leveling legs to prevent damage to floor.

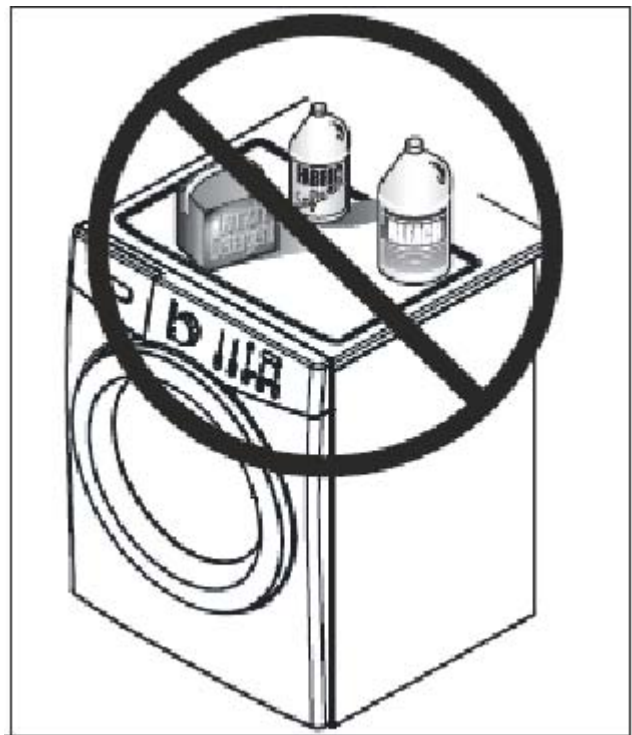

Do not store or place laundry products on top of dryer at any time. They can damage the finish or controls.

Avoid Service Checklist

Before calling for service, review this list. It may save both time and expense. The list includes common occurrences that are not the result of defective workmanship or materials in this dryer.

OCCURRENCE	POSSIBLE CAUSE	SOLUTION
Dryer does not start.	Electrical power cord is not securely plugged in or plug may be loose.	Make sure the plug fits tightly in wall outlet.
	House fuse blown or circuit breaker tripped.	Reset circuit breaker or replace fuse. Make sure electrical line is not overloaded and the dryer is on a separate circuit.
	Thermal limiter tripped.	Call authorized service person for replacement.
Dryer runs but won't heat.	There are 2 house fuses in the house fusebox. If 1 of the 2 fuses is blown, the drum may turn but the heater will not operate.	Replace fuse.
	Gas supply valve is not open (gas models).	Check to make sure supply valve is open. See INSTALLATION INSTRUCTIONS for procedure.
	Dryer does not have enough air supply to support the burner flame (gas models).	See INSTALLATION INSTRUCTIONS .
	LP gas supply tank is empty or there has been a utility interruption of natural gas (gas models).	Refill or replace tank. Dryer should heat when utility service is restored.
Drying cycle takes too long, outside of the dryer feels too hot or smells hot.	Lint screen is clogged with lint or fabric softner.	Make sure all lint has been removed from the dryer lint screen before starting each cycle.
	Exhaust duct requirements have not been met.	Exhaust duct must be at least 4 inches in diameter and made of rigid or flexible metal. When in place, the duct must have no more than two 90° bends and must not exceed length listed in INSTALLATION INSTRUCTIONS .
	Electric dryer is connected to a 208 volt circuit.	Drying time will be 20% longer than drying on a 240 volt circuit.
	Drying procedures have not been followed.	See Drying Procedures .
	Outside exhaust hood or exhaust duct may be clogged or restricted.	Clean out any obstruction.
	High humidity.	Use a dehumidifier near the dryer.
Excessive wrinkling.	Dryer is overloaded.	Do not overload. See Drying Procedures .
	Items left in dryer too long.	Remove items as soon as cycle ends.
	Insufficient sorting of items.	See Drying Procedures .
	Drying temperature too high.	Follow fabric care label instructions.

Avoid Service Checklist

Before calling for service, review this list. It may save both time and expense. The list includes common occurrences that are not the result of defective workmanship or materials in this dryer.

OCCURRENCE	POSSIBLE CAUSE	SOLUTION
Scratching or chipping of the drum finish.	Foreign objects such as coins, pins, clips or buttons are inside the dryer. Permanently attached items such as belt buckles, zippers and fasteners may be hitting the inside of the drum.	Always remove foreign objects from pockets before laundering. Remove objects from drum and restart dryer. It may be necessary to baste a scrap of material securely around ornaments before drying to prevent scratching and damage to the dryer. Drum damage caused by foreign objects or permanently attached items is not covered by the warranty.

FRIGIDAIRE DRYER WARRANTY

Your Frigidaire product is protected by this warranty

Sample warranty - always check warranty with product

	WARRANTY PERIOD	FRIGIDAIRE, THROUGH ITS AUTHORIZED SERVICERS, WILL:	THE CONSUMER WILL BE RESPONSIBLE FOR:
FULL ONE-YEAR WARRANTY	One year from original purchase date.	Pay all costs for repairing or replacing any parts of this appliance which prove to be defective in materials or workmanship.	Costs of service calls that are listed under IMPORTANT RESPONSIBILITIES OF THE CONSUMER.*
LIMITED WARRANTY (Applicable to the State of Alaska)	Time period listed above.	All of the provisions of the full warranty above and the exclusions listed below apply.	Costs of the technician's travel to the home and any costs for pick up and delivery of the appliance required because of service.

Your appliance is warranted by Frigidaire Home Products, a division of White Consolidated Industries, Inc. We authorize no person to change or add to any of our obligations under this warranty. Our obligations for service and parts under this warranty must be performed by Frigidaire or an authorized Frigidaire servicer.

This warranty applies only to products in ordinary household use, and the consumer is responsible for the items listed below:

***IMPORTANT RESPONSIBILITIES OF THE CONSUMER**

1. Proper use of the appliance in accordance with instructions provided with the product.
2. Proper installation by an authorized servicer in accordance with instructions provided with the appliance and in accordance with all local plumbing, electrical and/or gas codes.
3. Proper connection to a grounded power supply of sufficient voltage, replacement of blown fuses, repair of loose connections or defects in house wiring.
4. Expenses for making the appliance accessible for servicing, such as removal of trim, cupboards, shelves, etc., which are not a part of the appliance when it was shipped from the factory.
5. Damages to finish after installation.
6. Replacement of light bulbs and/or fluorescent tubes (on models with these features).

EXCLUSIONS

This warranty does not cover the following:

1. CONSEQUENTIAL OR INCIDENTAL DAMAGES SUCH AS PROPERTY DAMAGE AND INCIDENTAL EXPENSES RESULTING FROM ANY BREACH OF THIS WRITTEN OR ANY IMPLIED WARRANTY.
Note: Some states do not allow the exclusion or limitation of incidental or consequential damages, so this limitation or exclusion may not apply to you.
2. Service calls which do not involve malfunction or defects in workmanship or material, or for appliances not in ordinary household use. The consumer shall pay for such service calls.
3. Damages caused by services performed by servicers other than Frigidaire or its authorized servicers; use of parts other than genuine Frigidaire Home Products parts; obtained from persons other than such servicers; or external causes such as abuse, misuse, inadequate power supply or acts of God.
4. Products with original serial numbers that have been removed or altered and cannot be readily determined.

IF YOU NEED SERVICE

Keep your bill of sale, delivery slip, or some other appropriate payment record. The date on the bill establishes the warranty period should service be required. If service is performed, it is in your best interest to obtain and keep all receipts. This written warranty gives you specific legal rights. You may also have other rights that vary from state to state. Service under this warranty must be obtained by contacting Frigidaire Home Products:

800 • 944 • 9044
 Frigidaire Home Products
 P.O. Box 212378
 Augusta, GA 30917



Product features or specifications as described or illustrated are subject to change without notice. All warranties are made by White Consolidated Industries, Inc. This warranty applies only in the 50 states of the U.S.A. and Puerto Rico.

SECTION C - INSTALLATION INSTRUCTIONS GAS & ELECTRIC DRYER

Before beginning installation, carefully read these instructions. This will simplify the installation and ensure the dryer is installed correctly and safely. Leave these instructions near the Dryer after installation for future reference.

NOTE: The electrical service to the Dryer must conform with local codes and ordinances and the latest edition of the National Electrical Code, ANSI/NFPA 70, or in Canada, the Canadian electrical code C22.1 part 1.

NOTE: The gas service to the Dryer must conform with local codes and ordinances and the latest edition of the National Fuel Gas Code ANSI Z223.1, or in Canada, CAN/ACG B149.1-2000.

NOTE: The Dryer is designed under ANSI Z 21.5.1 or ANSI/UL 2158 - CAN/CSA C22.2 (latest editions) for HOME USE only. This Dryer is not recommended for commercial applications such as restaurants **or beauty salons, etc.**

⚠ WARNING For your safety the information in this manual must be followed to minimize the risk of fire or explosion or to prevent property damage, personal injury or loss of life.

- Do not store or use gasoline or other flammable vapors and liquid in the vicinity of this or any other appliance.

- **WHAT TO DO IF YOU SMELL GAS**

- Do not try to light any appliance.
- Do not touch any electrical switch; do not use any phone in your building.
- Clear the room, building or area of all occupants.
- Immediately call your gas supplier from a neighbor's phone. Follow the gas supplier's instructions.
- If you cannot reach your gas supplier, call the fire department.

Installation and service must be performed by a qualified installer, service agency or the gas supplier.

PRE-INSTALLATION REQUIREMENTS

Tools and Materials Required for Installation:

1. Phillips head screwdriver.
2. Channel-lock adjustable pliers.
3. Carpenter's level.
4. Flat or straight blade screwdriver.
5. Duct tape.
6. Rigid or flexible metal 4 inch (10.2 cm) duct.
7. Vent hood.
8. Pipe thread sealer (Gas).
9. Plastic knife

ELECTRICAL REQUIREMENTS

ELECTRIC Dryer

CIRCUIT - Individual 30 amp. branch circuit fused with 30 amp. minimum time delay fuses or circuit breakers.

POWER SUPPLY - 3 or 4 wire, 240 volt, single phase, 60 Hz, Alternating Current.

POWER SUPPLY CORD KIT - The dryer **MUST** employ a 3-conductor power supply cord NEMA 10-30 type SRDT rated at 240 volt AC minimum, 30 amp., with 3 open end spade lug connectors with upturned ends or closed loop connectors **OR** a 4-conductor power supply cord NEMA 14-30 type SRDT or ST (as required) rated at 240 volt AC minimum, 30 amp., with 4 open end spade lug connectors with upturned ends or closed loop connectors and marked for use with clothes dryers. If being installed in a **manufactured (mobile) home**, the dryer **MUST** employ a 4-conductor power supply cord NEMA 14-30 type SRDT or ST (as required) rated at 240 volt AC minimum, 30 amp., with 4 open end spade lug connectors with upturned ends or closed loop connectors and marked for use with clothes dryers. See ELECTRICAL CONNECTIONS FOR for additional instructions

OUTLET RECEPTACLE - NEMA 10-30R (3wire) receptacle or NEMA 14-30R (4wire) receptacle to be located so the power supply cord is accessible when the dryer is in the installed position.



NEMA 10-30R



NEMA 14-30R

Gas Dryer

CIRCUIT - Individual 15 amp. branch circuit fused with a 15 amp. maximum time delay fuse or circuit breaker.

POWER SUPPLY - 3 wire, 120 volt single phase, 60 Hz, Alternating Current.

POWER SUPPLY CORD - The dryer is equipped with a 120 volt 3-wire power cord.

Use separately fused circuits for washers and dryers, and **DO NOT** operate a washer and a dryer on the same circuit.

NOTE: Do not under any circumstances remove grounding prong from plug.

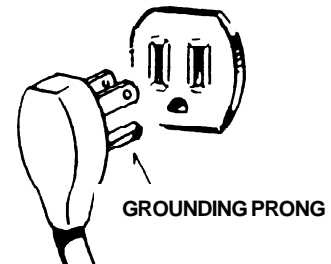

EXHAUST SYSTEM REQUIREMENTS

Use only 4 inch (10.2 cm) diameter (minimum) rigid or flexible **metal** duct and approved vent hood which has a swing-out damper(s) that open when the dryer is in operation. When the dryer stops, the dampers automatically close to prevent drafts and the entrance of insects and rodents. To avoid restricting the outlet, maintain a minimum of 12 inches (30.5 cm) clearance between the vent hood and the ground or any other obstruction.

! WARNING The following are specific requirements for proper and safe operation of your dryer. Failure to follow these instructions can create excessive drying times and fire hazards.

! WARNING Do not use plastic flexible duct to exhaust the dryer. Excessive lint can build up inside

exhaust system and create a fire hazard and restrict air flow. Restricted air flow will increase dryer times. If your present system is made up of plastic duct or metal foil duct, **replace it** with a rigid or flexible metal duct. **Ensure the present duct is free of any lint prior to installing dryer duct.**

WARNING If the dryer is not exhausted outdoors, some fine lint will be expelled into the laundry area. An accumulation of lint in any area of the home can create a health and fire hazard. **The dryer exhaust system MUST be exhausted to the outside of the dwelling!**

WARNING Do not allow combustible materials (for example: clothing, draperies/curtains, paper) to come in contact with exhaust system. The dryer **MUST NOT** be exhausted into a chimney, a wall, a ceiling, or any concealed space of a building which can accumulate lint, resulting in a fire hazard.

WARNING Exceeding the length of duct pipe or number of elbows allowed in the "MAXIMUM LENGTH" charts can cause an accumulation of lint in the exhaust system. Plugging the system could create a fire hazard, as well as increase drying times.

WARNING Do not screen the exhaust ends of the vent system, nor use any screws or rivets to assemble the exhaust system. Lint can become caught in the screen, on the screws or rivets, clogging the duct work and creating a fire hazard as well as increasing drying times. Use an approved vent hood to terminate the duct outdoors, and seal all joints with duct tape. All male duct pipe fittings **MUST** be installed downstream with the flow of air.

WARNING Explosion hazard. Do not install the dryer where gasoline or other flammables are kept or stored. If the dryer is installed in a garage, it must be a minimum of 18 inches (45.7 cm) above the floor. Failure to do so can result in death, explosion, fire or burns.

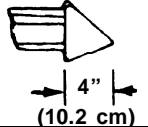
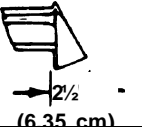
MAXIMUM LENGTH of 4" (10.2 cm) Dia. Rigid Metal Duct			
VENT HOOD TYPE			
(Preferred)			
Number of 90° Turns		Louvered	
	0	60 ft. (18.28 m)	
1	52 ft. (15.84 m)		40 ft. (12.19 m)
2	44 ft. (13.41 m)		32 ft. (9.75 m)
3	32 ft. (9.75 m)		24 ft. (7.31 m)
4	28 ft. (8.53 m)		16 ft. (4.87 m)

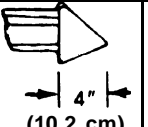
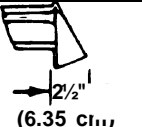
MAXIMUM LENGTH of 4" (10.2 cm) Dia. Flexible Metal Duct			
VENT HOOD TYPE			
(Preferred)			
Number of 90° Turns		Louvered	
	0	30 ft. (9.14 m)	
1	22 ft. (6.71 m)		14 ft. (4.27 m)
2	14 ft. (4.27 m)		10 ft. (3.05 m)
3	NOT RECOMMENDED		

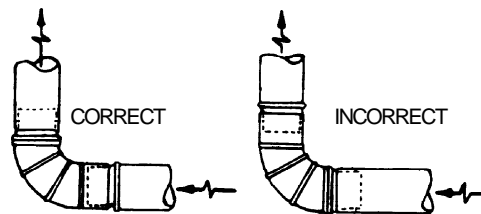

INSTALL MALE FITTINGS IN CORRECT DIRECTION

In installations where the exhaust system is not described in the charts, the following method must be used to determine if the exhaust system is acceptable:

1. Connect an inclined or digital manometer between the dryer and the point the exhaust connects to the dryer.
2. Set the dryer timer and temperature to air fluff (cool down) and start the dryer.
3. Read the measurement on the manometer.
4. The system back pressure **MUST NOT** be higher than 0.75 or lower than .10 inches of water column. If the system back pressure is less than 0.75 inches and more than .10 inches of water column, the system is acceptable. If the manometer reading is

higher than 0.75 inches of water column, the system is too restrictive and the installation is unacceptable.

Although vertical orientation of the exhaust system is acceptable, certain extenuating circumstances could affect the performance of the dryer:

- Only the rigid metal duct work should be used.
- Venting vertical through a roof may expose the exhaust system to down drafts causing an increase in vent restriction.
- Running the exhaust system through an uninsulated area may cause condensation and faster accumulation of lint.
- Compression or crimping of the exhaust system will cause an increase in vent restriction.

The exhaust system should be inspected and cleaned a minimum of **every 18 months** with normal usage. The more the dryer is used, the more often you should check the exhaust system and vent hood for proper operation.

EXHAUST DIRECTION

All dryers shipped from the factory are set up for rear exhausting. However, on electric dryers, exhausting can be to the right or left side of the cabinet or the bottom of the dryer. On gas dryers, exhausting can be to the right side of the cabinet or the bottom of the dryer. Directional exhausting can be accomplished by installing Exhaust Kit, P/N 131456800, available through your parts distributor. Follow the instructions supplied with the kit.

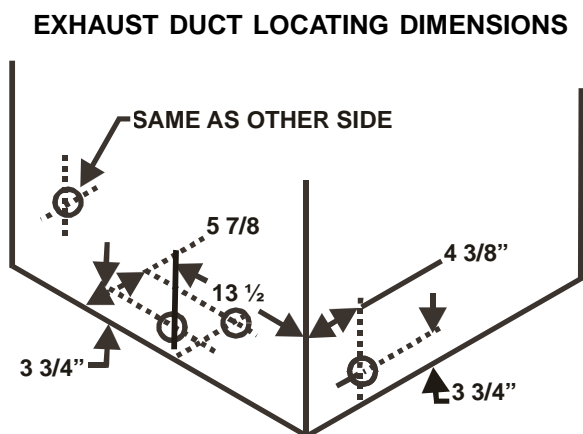

GAS SUPPLY REQUIREMENTS

⚠ WARNING Replace copper connecting pipe that is not plastic-coated. Stainless steel or plastic-coated brass **MUST** be used.

1. Installation **MUST** conform with local codes, or in the absence of local codes, with the National Fuel Gas Code, ANSI Z223.1 (latest edition)
2. The gas supply line should be of 1/2 inch (1.27 cm) pipe.
3. If codes allow, flexible metal tubing may be used to connect your dryer to the gas supply line. The tubing **MUST** be constructed of stainless steel or plastic-coated brass.
4. The gas supply line **MUST** have an individual shutoff valve.
5. A 1/8 inch (0.32 cm) N.P.T. plugged tapping, accessible for test gauge connection, **MUST** be installed immediately upstream of the gas supply connection to the dryer.
6. The dryer **MUST** be disconnected from the gas supply piping system during any pressure testing of the gas supply piping system at test pressures in excess of 1/2 psig (3.45 kPa).
7. The dryer **MUST** be isolated from the gas supply piping system during any pressure testing of the gas supply piping system at test pressures equal to or less than 1/2 psig (3.45 kPa).

LOCATION OF YOUR DRYER

DO NOT INSTALL YOUR DRYER:

1. In an area exposed to dripping water or outside weather conditions.
2. In an area where it will come in contact with curtains, drapes, or anything that will obstruct the flow of combustion and ventilation air.
3. On carpet. Floor **MUST** be solid with a maximum slope of 1 inch (2.54 cm).

INSTALLATION IN RECESS OR CLOSET

1. A dryer installed in a bedroom, bathroom, recess or closet, **MUST** be exhausted outdoors.
2. No other fuel burning appliance shall be installed in the same closet as the Gas dryer.
3. Your dryer needs the space around it for proper ventilation.

DO NOT INSTALL YOUR DRYER IN A CLOSET WITH A SOLID DOOR.

4. A minimum of 120 square inches (774.2 square cm) of opening, equally divided at the top and bottom of the door, is required. Air openings are required to be unobstructed when a door is installed. A louvered door with equivalent air openings for the full length of the door is acceptable.

MINIMUM INSTALLATION CLEARANCES (Inches)

	SIDES	REAR	TOP	FRONT
Alcove	0 (0 cm)	0 (0 cm)	15 (38.1 cm)	
Closet	0 (0 cm)	0 (0 cm)	15 (38.1 cm)	1 (2.54 cm)

Closet door ventilation required: 2 louvered openings each 60 square inches (387 square centimeters) — 3 inches (7.6 cm) from bottom and top of door.

NOTE: Under counter and stack models - 0 inches (0 cm) for sides, rear, and top.

THIS DRYER MUST BE EXHAUSTED OUTDOORS.

5. The following illustrations show minimum clearance dimensions for proper operation in a recess or closet installation.

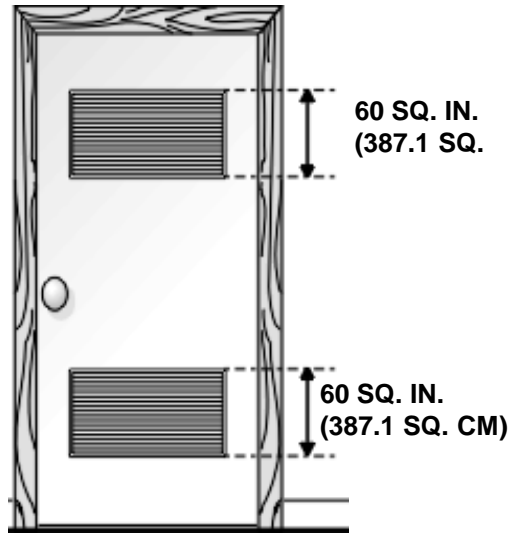

CLOSET DOOR

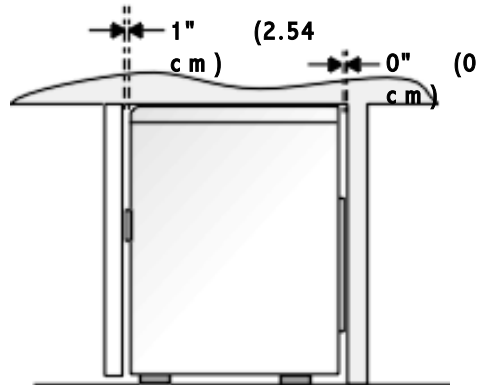
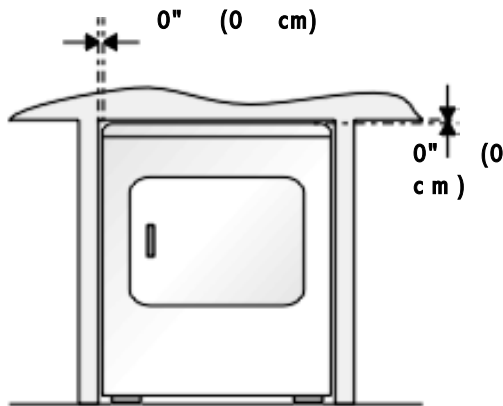

Dryer Installation Dimensions

Free-Standing & Under Counter

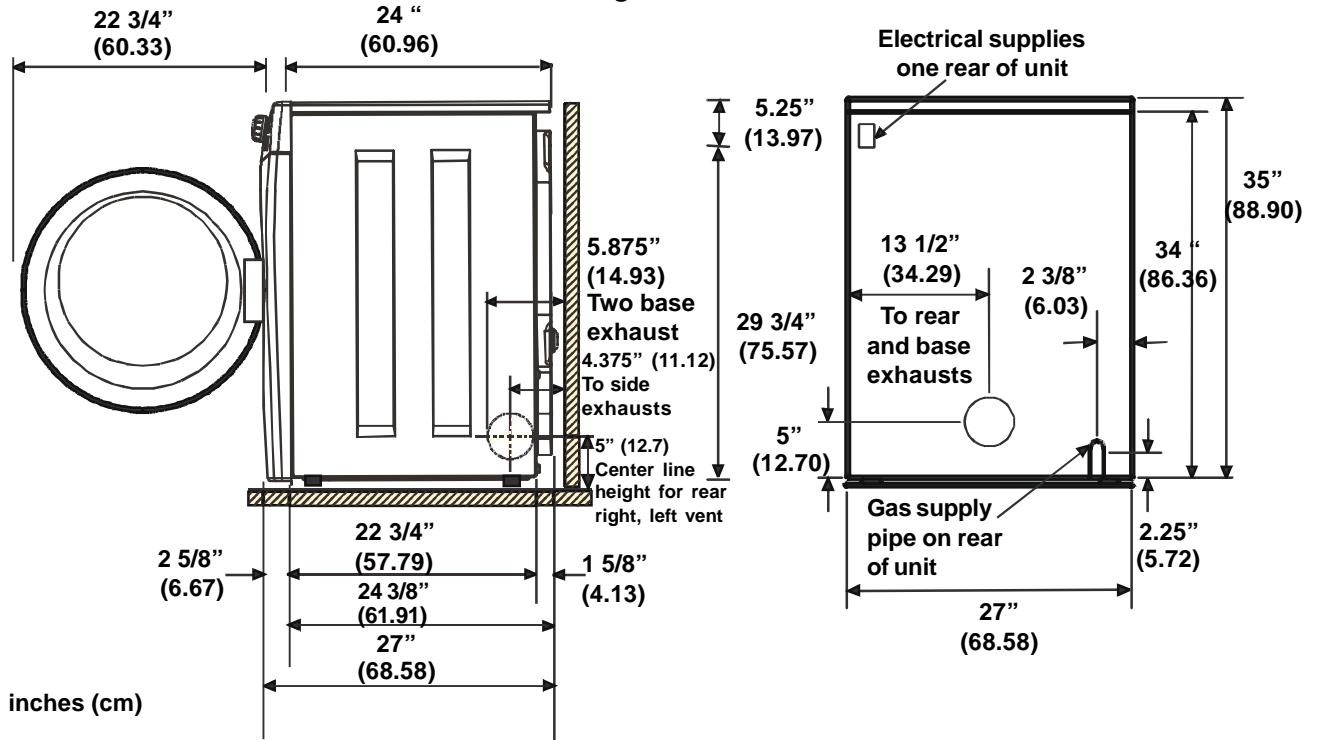

Stacked Dryer Installation Dimensions

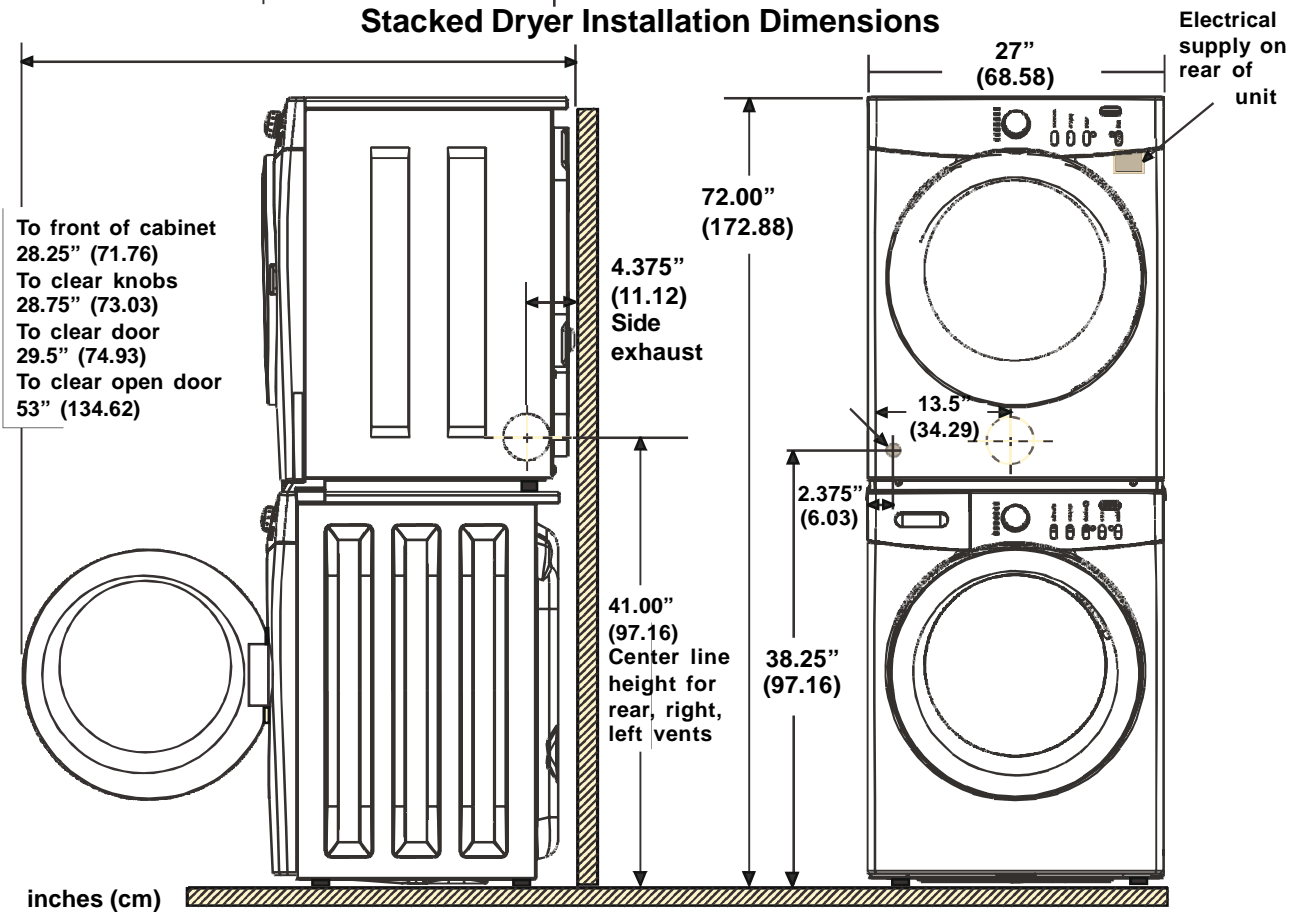

MOBILE HOME INSTALLATION

1. Dryer **MUST** be exhausted outside (outdoors, not beneath the mobile home) using metal ducting that will not support combustion. Metal ducting must be 4 inches (10.16 cm) in diameter with no obstructions. Rigid metal duct is preferred.
2. If dryer is exhausted through the floor and area beneath the mobile home is enclosed, the exhaust system **MUST** terminate outside the enclosure with the termination securely fastened to the mobile home structure.
3. When installing a gas dryer into a mobile home, a provision must be made for outside make up air. This provision is to be not less than twice the area of the dryer exhaust outlet.
4. This dryer **MUST** be fastened to the floor. Mobile Home Installation Kit No. 346764 is available from your dealer.
5. Refer to other important venting requirements.
6. Installation **MUST** conform to current Manufactured Home Construction & Safety Standard (which is a Federal Regulation Title 24 CFR-Part 32-80) or when such standard is not applicable, with American National Standard for Mobile Homes.

WARNING The dryer is designed under ANSI Z 21.5.1 or ANSI/UL2158 - CAN/CSA C22.2 (latest editions) for **HOME USE** only.

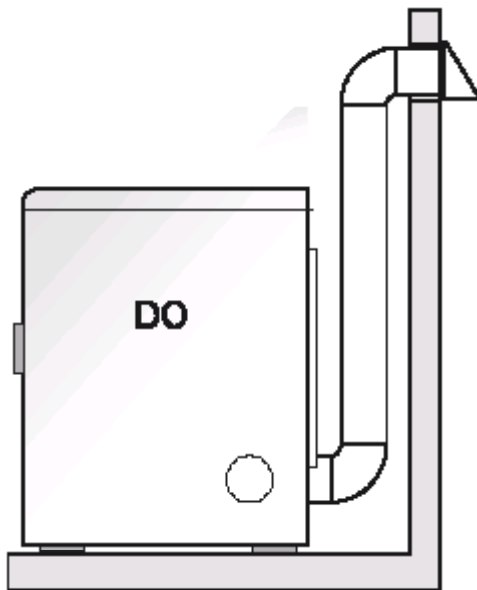

Correct

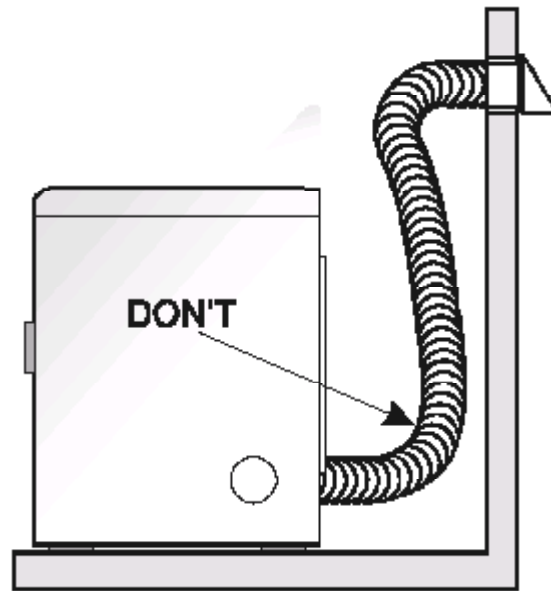

Incorrect

UNPACKING

1. Using a rug, blanket or a piece of cardboard packing to protect the floor, carefully lay the dryer on its left side and remove the foam shipping base.

CAUTION To prevent damage, do not use the control panel as a means to pick up or move the dryer.

2. Return the dryer to an upright position.

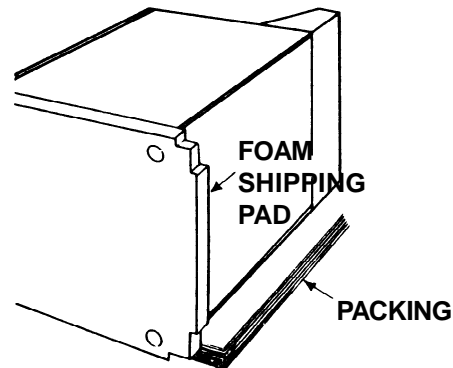

DRYER DOOR REVERSAL INSTRUCTIONS

1. Open the dryer door.

2. Remove the two screws that secure the hinge to the front panel. **NOTE:** Remove the bottom screw first. Support the door assembly firmly before removing the top screw.

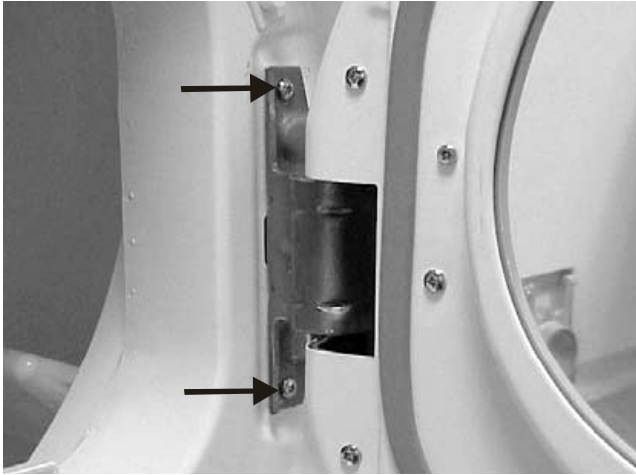

3. Remove the door assembly by lifting and pulling outward from unit.
4. Place door assembly face down on a soft flat surface.
5. Remove the catch plate from the front panel. Rotate and reinstall it in the position vacated by the hinge.

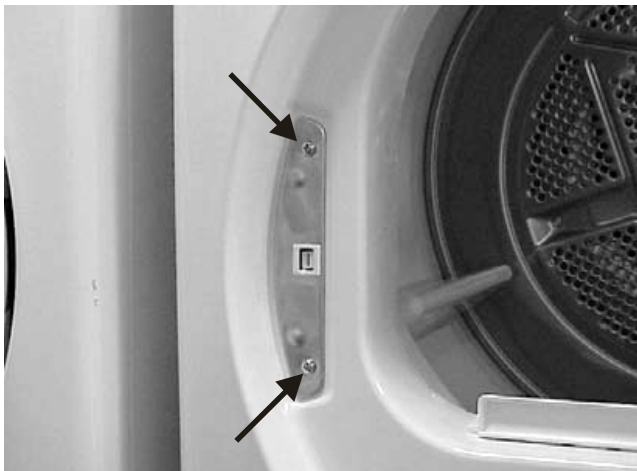

6. Remove the five screws (black arrows) and the two screws (white arrows) that attach the inner door assembly to the outer door assembly. Lift the inner door assembly out of the outer door assembly.

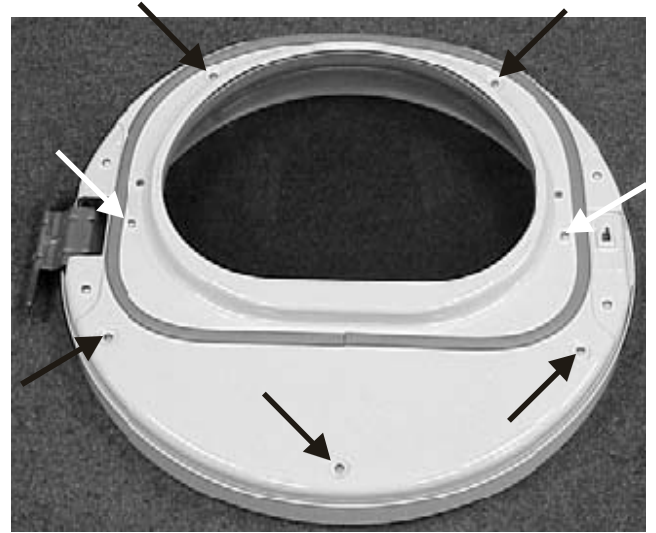

7. Remove the screws that attach the hinge (white arrows) and strike plate (black arrows).



8. Rotate the hinge and strike plate and reattach them to the opposite sides of the inner door.

- Remove the hinge cutout plug. Rotate it and install it in the opposite side of the outer door.

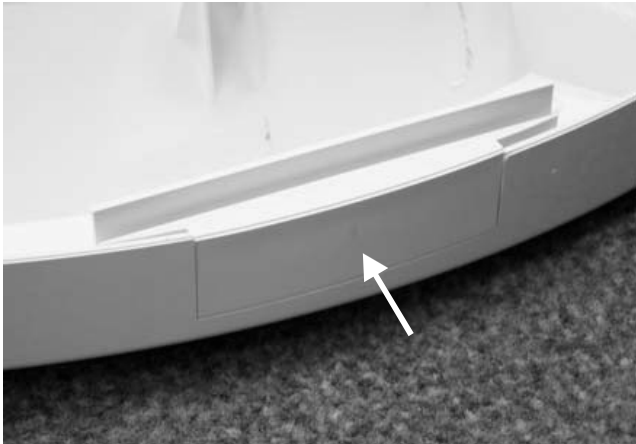

- Reposition the inner door assembly in the outer door assembly.
- Reinstall the five screws and the two screws that attach the inner door assembly to the outer door assembly.
- Support the door assembly firmly, insert the hinge hook into the hole in the front panel and lift to align the screw holes.
- While supporting the door assembly, install the mounting screws.
- Close the door.

ELECTRICAL INSTALLATION

ELECTRIC Dryers

⚠ WARNING The following are specific requirements for proper and safe electrical installation of your dryer. Failure to follow these instructions can create electrical shock and/or a fire hazard.

⚠ This appliance **MUST** be properly grounded. Electrical shock can result if the dryer is not properly grounded. Follow the instructions in this manual for proper grounding.

⚠ Do not use an extension cord with this dryer. Some extension cords are not designed to withstand the amounts of electrical current this dryer utilizes and can melt, creating electrical shock and/or fire hazard. Locate the dryer within reach of the receptacle for the length power cord to be purchased, allowing some slack in the cord. Refer to the pre-installation requirements in

this manual for the proper power cord to be purchased.

⚠ A U.L. approved strain relief must be installed onto power cord. If the strain relief is not attached, the cord can be pulled out of the dryer and can be cut by any movement of the cord, resulting in electrical shock.

⚠ Do not use an aluminum wired receptacle with a copper wired power cord and plug (or vice versa). A chemical reaction occurs between copper and aluminum and can cause electrical shorts. The proper wiring and receptacle is a copper wired power cord with a copper wired receptacle.

NOTE: Dryers operating on 208 volt power supply will have longer drying times than operating on 240 volt power supply.

GROUNDING REQUIREMENTS

NON-CANADIAN ELECTRIC Dryer

⚠ WARNING Improper connection of the equipment grounding conductor can result in a risk of electrical shock. Check with a licensed electrician if you are in doubt as to whether the appliance is properly grounded.

For a grounded, cord-connected dryer:

- The dryer **MUST** be grounded. In the event of a malfunction or breakdown, grounding will reduce the risk of electrical shock by a path of least resistance for electrical current.
- If your dryer is equipped with a power supply cord having an equipment-grounding conductor and a grounding plug, the plug **MUST** be plugged into an appropriate, copper wired receptacle that is properly installed and grounded in accordance with all local codes and ordinances. If in doubt, call a licensed electrician. **Do not modify plug provided with the appliance.**

For a permanently connected dryer:

- The dryer **MUST** be connected to a grounded metal, permanent wiring system; or an equipment grounding conductor must be run with the circuit conductors and connected to the equipment-grounding terminal or lead on the appliance.

Canadian ELECTRIC Dryer

⚠ DANGER Improper connection of the equipment grounding conductor can result in a risk of electrical shock. Check with a licensed electrician if you are in doubt as to whether the appliance is properly grounded. For a grounded, cord-connected dryer:

1. The dryer must be grounded. In the event of a malfunction or breakdown, grounding will reduce the risk of electrical shock by a path of least resistance for electrical current.
2. Since your dryer is equipped with a power supply cord having an equipment-grounding conductor and a grounding plug, the plug must be plugged into an appropriate outlet that is properly installed and grounded in accordance with all local codes and ordinances. If in doubt, call a licensed electrician.
Do not modify plug provided with the appliance.

ALL GAS Dryers

This dryer is equipped with a three-prong (grounding plug) for your protection against shock hazard and should be plugged directly into a properly grounded three-prong receptacle. Do not cut or remove the grounding prong from this plug.

ELECTRICAL CONNECTIONS FOR 3-WIRE SYSTEM

NON-CANADIAN ELECTRIC Dryer

1. Remove the screws securing the terminal block access cover and the strain relief mounting bracket located on the back of the dryer upper corner.
2. Install a U.L. approved strain relief into the power cord entry hole of the mounting bracket. Finger tighten the nut only at this time.
3. Thread a U.L. approved 30 amp. power cord, NEMA 10-30 type SRDT, through the strain relief.
4. Attach the power cord neutral (center wire) conductor to the silver colored center terminal on the terminal block. Tighten the screw securely.
5. Attach the remaining two power cord outer conductors to the outer brass colored terminals on the terminal block. Tighten both screws securely.

⚠ WARNING Do not make a sharp bend or crimp wiring/conductor at connections.

6. Reattach the strain relief mounting bracket to the back of the dryer with two screws. Tighten screws securely.
7. Tighten the screws securing the cord restraint firmly against the power cord.

8. Tighten the strain relief nut securely so that the strain relief does not turn.
9. Reinstall the terminal block cover.

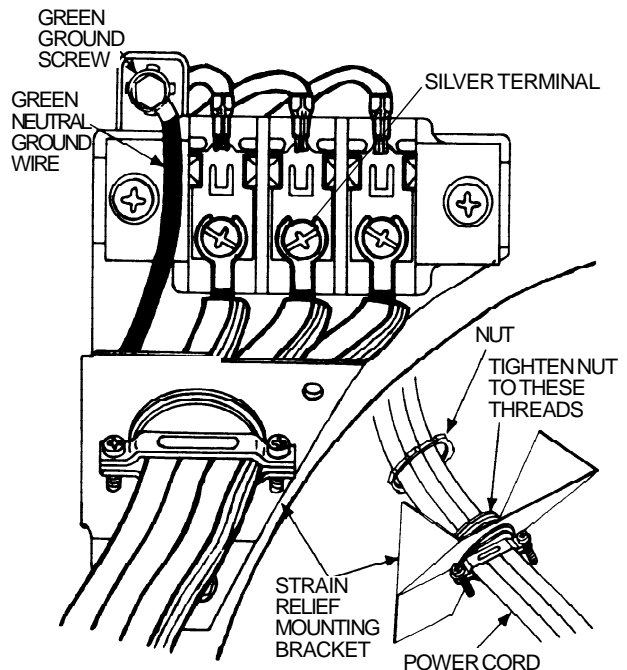

This dryer is equipped with a three-prong (grounding) plug for your protection against shock hazard and should be plugged directly into a properly grounded three-prong receptacle. Do not cut or remove the grounding prong from this plug.

ELECTRICAL CONNECTIONS FOR 4-WIRE SYSTEM

NON-CANADIAN ELECTRIC Dryer

1. Remove the screws securing the terminal block access cover and the strain relief mounting bracket located on the back of the dryer upper corner.
2. Install a U.L. approved strain relief in the entry hole of the mounting bracket. Finger tighten the nut only at this time.

- Remove the green neutral ground wire from the green ground screw located above the terminal block.

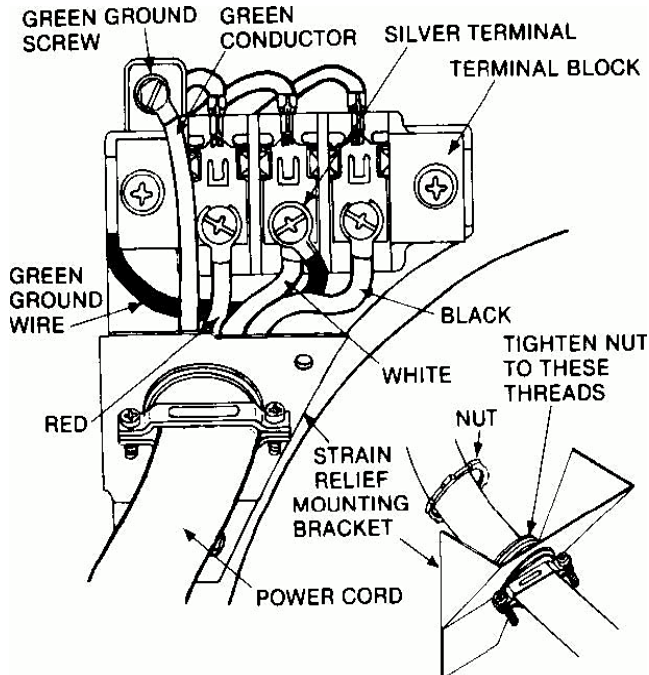

- Thread a U.L. approved 30 amp power cord, NEMA 14-30 type ST or SRDT through the strain relief.

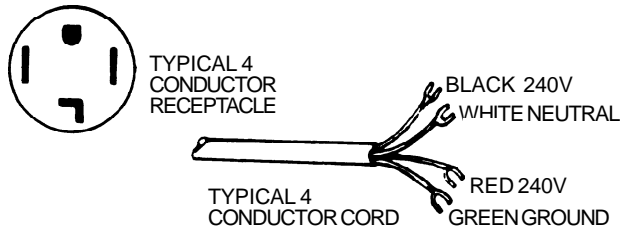

30 AMP NEMA 14-30 TYPE SRDT OR ST

- Attach the green power cord ground wire to the cabinet with the green ground screw.
- Attach the white (neutral) power cord conductor from the power cord and the green ground wire from the dryer harness to the silver-colored center terminal on the terminal block. Tighten the screw securely.
- Attach the red and black power cord conductors to the outer brass-colored terminals on the terminal block.

⚠ WARNING Do not make a sharp bend or crimp wiring/ conductor at the connections.

- Tighten the screws securing the cord restraint firmly against the power cord.
- Tighten the strain relief nut securely so the strain relief does not turn.
- Reinstall the terminal block access cover.

GAS CONNECTION

- Remove the shipping cap from gas pipe at the rear of the dryer.

NOTE: DO NOT connect the dryer to L.P. gas service without converting the gas valve. An L.P. conversion kit must be installed by a qualified gas technician.

- Connect a 1/2 inch (1.27 cm) I.D. semi-rigid or approved pipe from gas supply line to the 3/8 inch (0.96 cm) pipe located on the back of the dryer. Use a 1/2 inch to 3/8 inch (1.27 cm to 0.96 cm) reducer for a connection. Apply an approved thread sealer that is resistant to the corrosive action of liquefied gases on all pipe connections.

- Open the shutoff valve in the gas supply line to allow gas to flow through pipe.

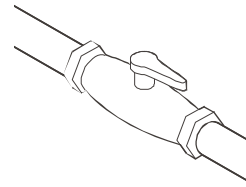

VALVE OPEN/GAS FLOW POSITION

- Test all connections by brushing on a soapy water solution. **NEVER TEST FOR GAS LEAKS WITH AN OPEN FLAME.**

GENERAL INSTALLATION

- Connect the exhaust duct to outside exhaust system. Use duct tape to seal all joints.

- With the dryer in its final position, adjust one or more of the legs until the dryer is resting solid on all four legs. Place a level on top of the dryer. **THE DRYER MUST BE LEVEL AND RESTING SOLID ON ALL FOUR LEGS.**

- Plug the power cord into a grounded outlet.

NOTE: Check to ensure the power is off at circuit breaker/ fuse box before plugging the power cord into the outlet.

- Turn on the power at circuit breaker/fuse box.

⚠ CAUTION Before operating the dryer, make sure the dryer area is clear and free from combustible materials, gasoline, and other flammable vapors. Also see that nothing (such as boxes, clothing, etc.) obstructs the flow of combustion and ventilation air.

5. Run the dryer through a cycle check for proper operation.

NOTE: On gas dryers, before the burner will light, it is necessary for the gas line to be bled of air. If the burner does not light within 45 seconds the first time the dryer is turned on, the safety switch will shut the burner off. If this happens, turn the timer to "OFF" and wait 5 minutes before making another attempt to light.

6. If your dryer does not operate, please review the "Avoid Service Checklist" located in your Use and Care Guide before calling for service.

7. Place these instructions in a location near the dryer for future reference.

NOTE: A wiring diagram/tech sheet is on the right-hand bodyside behind the front panel and inside rear access panel.

REPLACEMENT PARTS

If replacements parts are needed for your dryer, contact the source where you purchased your dryer, call 1-800-944-9044, or visit our website, www.frigidaire.com, for the Frigidaire Company Authorized Parts Distributor nearest you.

⚠ CAUTION Label all wires prior to disconnection when servicing controls. Wiring errors can cause improper and dangerous operation. Verify proper operation after servicing.

⚠ WARNING Destroy the carton and plastic bags after the dryer is unpacked. Children might use them for play. Cartons covered with rugs, bedspreads, or plastic sheets can become airtight chambers causing suffocation. Place all materials in a garbage container or make materials inaccessible to children.

⚠ WARNING The instructions in this manual and all other literature included with this dryer are not meant to cover every possible condition and situation that may occur. Good safe practice and caution **MUST** be applied when installing, operating and maintaining any appliance.

SECTION D - Washer & Dryer 15" Drawer Pedestal Installation Instructions

IMPORTANT: Read and save these instructions.

NOTICE! This kit is intended to be installed by persons having electrical and mechanical training and a level of knowledge considered acceptable in the appliance repair trade.

Your safety and the safety of others are very important. Many important safety messages are provided in these instructions and on your appliance. Always read and obey all safety messages.

WARNING
EXCESSIVE WEIGHT HAZARD
 Two or more people may be required to move and install the washer & dryer onto pedestals. Failure to comply may cause back or other injury.

- Tools needed:**
- level
 - 9/16" open end wrench
 - #2 Phillips screwdriver

Washer/Dryer Installation Kit

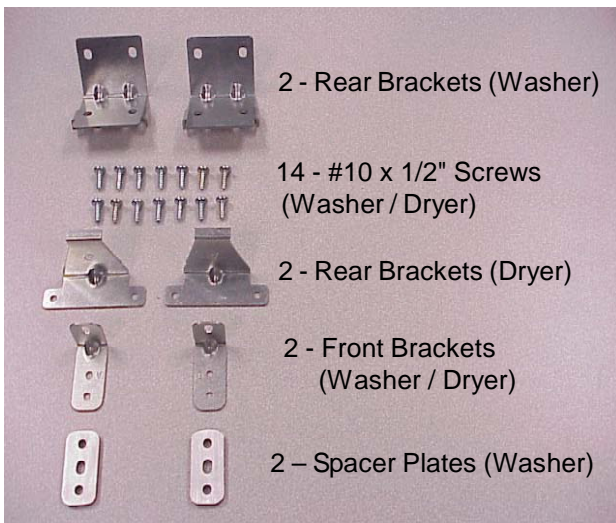

Picture 1

WASHER INSTALLATION

1. Remove the washer installation hardware from the plastic bag as shown in Picture 1.
2. Attach the rear brackets to the pedestal with four #10 screws (2 per bracket) as shown in Picture 2.

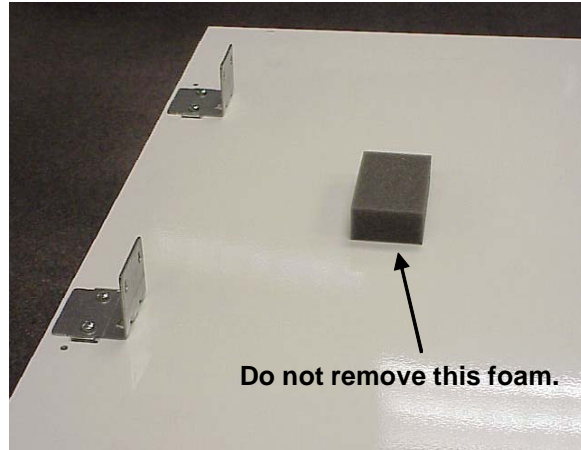

Picture 2

3. Attach the front brackets and spacer plates to the pedestal with four #10 screws (2 per bracket) as shown in Picture 3 and 4.

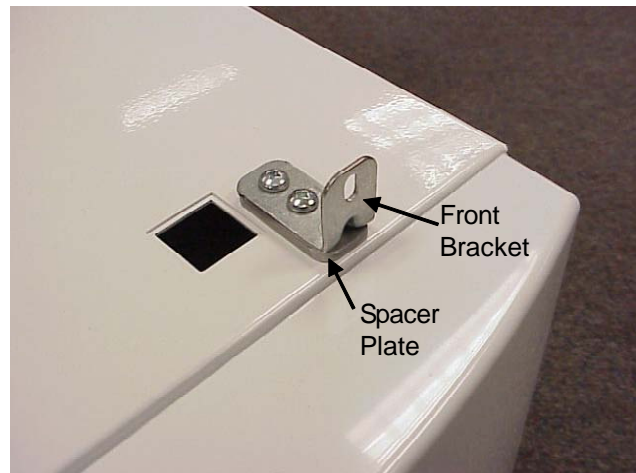

Picture 3



Picture 4



Picture 6

NOTE: If washer was previously installed, disconnect the power cord, remove the inlet hoses from the water faucets and tape the drain hose to the top of the washer to eliminate excess water on the floor.

- Using two or more people, carefully lift the washer onto the pedestal, tilting the washer back slightly to align the holes in the rear of the washer with the slots of the rear brackets on the pedestals. See Pictures 5 and 6.

NOTE: If the mounting holes do not align, make sure the washer leveling legs are adjusted fully into the washing machine. Turn each leg tight to the base.

- Set the washer down onto the pedestal making sure the washer base is behind the front brackets of the pedestal. See Picture 7.



Picture 7



Picture 5

- Align the sides of the washer with the sides of the pedestal and attach the washer to the rear brackets using four #10 screws (2 per bracket) as shown in Picture 8.



Picture 8

- With the pedestal drawer open for better access, install the two #10 screws through the front brackets in the pedestal into the washer base as shown in Picture 9.



Picture 9

- After closing the pedestal drawer, carefully move the washer/pedestal assembly into position.

NOTE: Because of the increased weight caused by the addition of the pedestal, two or more people may be required.

- Excessive noise and vibration can be prevented by properly leveling the washer/pedestal assembly on a SOLID floor and tightening the leveling leg lock nuts.**

With the washer/pedestal assembly in its' final position, place a level on top of the washer. Adjust the pedestal leveling legs so the washer/pedestal assembly is level front-to-rear and side-to side, and stable corner-to-corner.

Press down on alternate corners and sides and feel for the slightest movement. Adjust the appropriate leg so the washer/pedestal assembly is SOLID on the floor on ALL four pedestal legs.

After leveling the washer/pedestal assembly, adjust the lock nut on each pedestal leveling leg against the pedestal base and tighten with a wrench. Keep the leg extension at a minimum to prevent excessive vibration.

- Refer to the Installation Instructions that came with the washer to properly complete electrical, water, and drain connections. If questions arise, please refer to the Owner's Guide that came with the washer for contact information.

DRYER INSTALLATION

- Remove the dryer installation hardware from the plastic bag as shown in Picture 1.
- Attach the rear brackets to the pedestal with four #10 screws (2 per bracket) as shown in Picture 10.

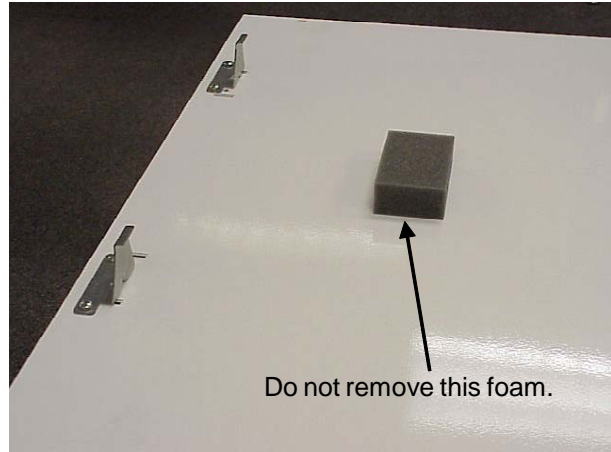

Picture 10

- Attach the front brackets to the pedestal with four #10 screws (2 per bracket) as shown in Picture 11.

NOTE: The spacer plates shown in Pictures 1 and 3 are not required for the Dryer installation.



Picture 11

NOTE: If the dryer was previously installed, disconnect the power cord and the vent hose. Also make sure the leveling legs are adjusted fully into the dryer.

- Using two or more people, carefully lift the dryer onto the pedestal, tilting the dryer back slightly to engage the slots in the rear of the dryer with the tabs of the rear brackets on the pedestal. See Pictures 12 and 13.



Picture 12



Picture 13

- Set the dryer down onto the pedestal making sure the service panel bracket on the dryer is behind the front brackets of the pedestal. See Picture 14.



Picture 14

- With the pedestal drawer open for better access, install two #10 screws through the front brackets in the pedestal into the service panel bracket of the dryer as shown in Picture 15.



Picture 15

- After closing the pedestal drawer, carefully move the dryer/pedestal assembly into position.

NOTE: Because of the increased weight caused by the addition of the pedestal, two or more people may be required.

- Excessive noise and vibration can be prevented by properly leveling the dryer/pedestal assembly on a SOLID floor and tightening the leveling leg lock nuts.**

With the dryer/pedestal assembly in its' final position, place a level on top of the dryer. Adjust the pedestal leveling legs so the dryer/pedestal assembly is level front-to-rear and side-to side, and stable corner-to-corner.

Press down on alternate corners and sides and feel for the slightest movement. Adjust the appropriate leg so the dryer/pedestal assembly is SOLID on the floor on ALL four pedestal legs.

After leveling the dryer/pedestal assembly, adjust the lock nut on each pedestal leveling leg against the pedestal base and tighten with a wrench. Keep the leg extension at a minimum to prevent excessive vibration.

- Refer to the Installation Instructions that came with the dryer to properly complete electrical and venting connections. If questions arise, please refer to the Owner's Guide that came with the dryer for contact information.

6. With the pedestal drawer open for better access, install the two #10 screws through the front brackets in the pedestal into the service panel bracket of the dryer.



7. After closing the pedestal drawer, carefully move the dryer/pedestal assembly into position.

NOTE: Because of the increased weight caused by the addition of the pedestal, two or more people may be required.

NOTE: The dryer/pedestal assembly MUST be on a solid floor and level for proper operation. After leveling the dryer/pedestal assembly, adjust the lock nut on each leveling leg against the pedestal base and tighten with a wrench. Keep the leg extension at a minimum to prevent excessive vibration.

8. Refer to the installation instructions that came with the dryer to properly complete electrical and venting connections. If questions arise, please refer to the Owner's Guide that came with the dryer for contact information.

WARRANTY

Full One Year Warranty on Mechanical Parts

Sample warranty - always check warranty with product

For one year from date of purchase, when this pedestal is installed with the listed washer or dryer (see owners manual for specific model) and operated according to the information in the Use and Care Guide, Operating Instructions and Installation Instructions, the supplier will replace any of its mechanical parts if they are defective in workmanship or material. Keep your bill of sale. The date of the bill establishes the warranty period should parts be required. This written warranty gives you specific rights. You may also have other rights which vary from state to state.

Warranty Restriction

If the pedestal is used for any other purpose than private family use or used with any product that requires modification for installation, the warranty is null and void.

Warranty Parts

Warranty parts are available by contacting the supplier where the pedestal was purchased or refer to the Use and Care Guide that came with the washer or dryer that is installed on the pedestal for contact information.

SECTION E - HOW THE COMPONENTS WORK

Clothes dryers remove moisture from clothes by pulling air, either warmed or room temperature, through the clothes while they are being tumbled by a turning drum. The moisture from the clothes is exhausted through the dryer vent system to the outside of the house.

The basic components are :

Drum



Heat Source

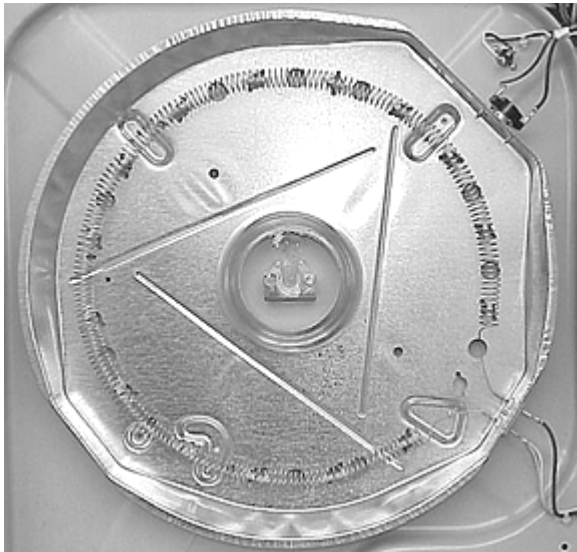

Electric

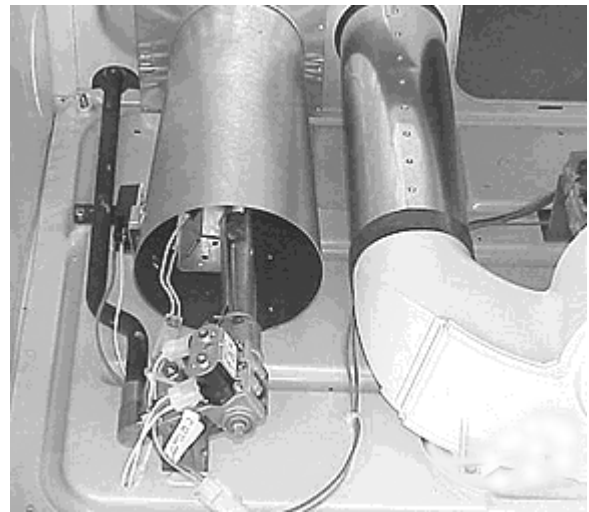

Gas

Drive motor and blower

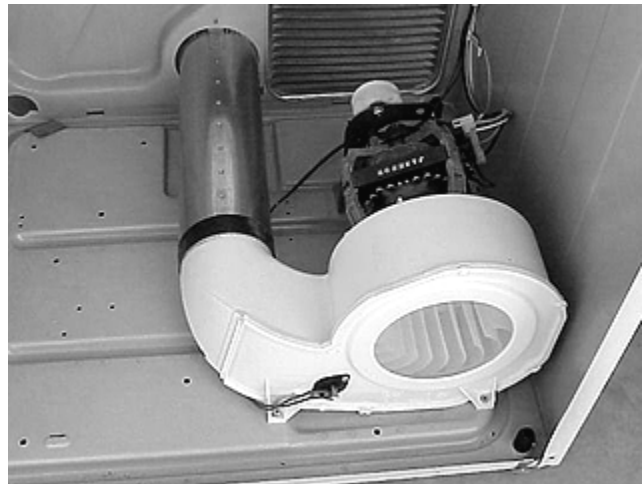

Control thermistor

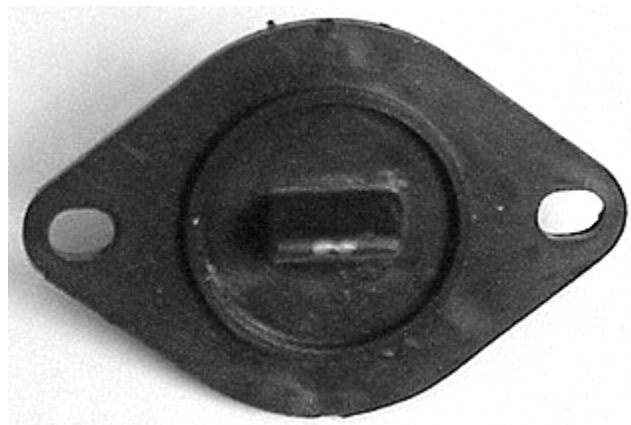

Electronic control board

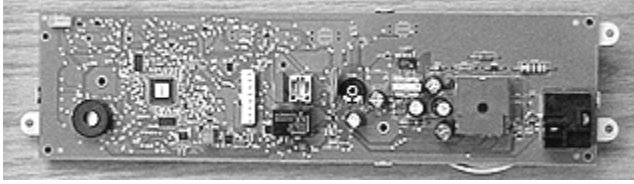

Airflow

Since the moisture in the clothes is removed by air moving through the drum, it is important to understand the complete air flow system.

Airflow electric dryers:

Room air enters the dryer through a louvered panel in the rear right-hand corner of the dryer.

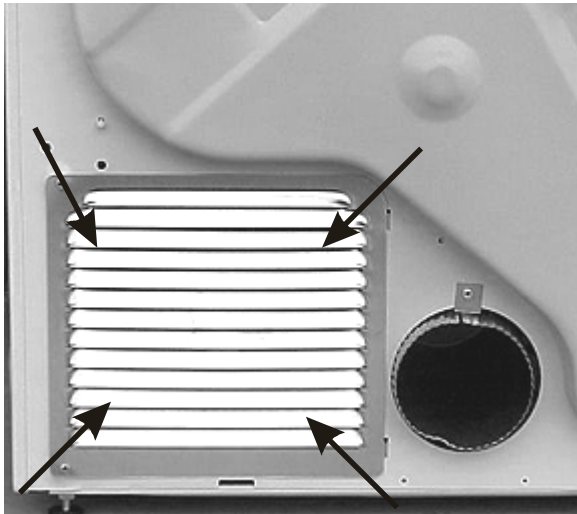

Once inside the dryer cavity the air is drawn between the rear wall of the dryer and the plenum. The holes in

the plenum allow the air to be drawn across the heating element. In any cycle, other than Air Fluff, the heating element heats the air as it passes through.

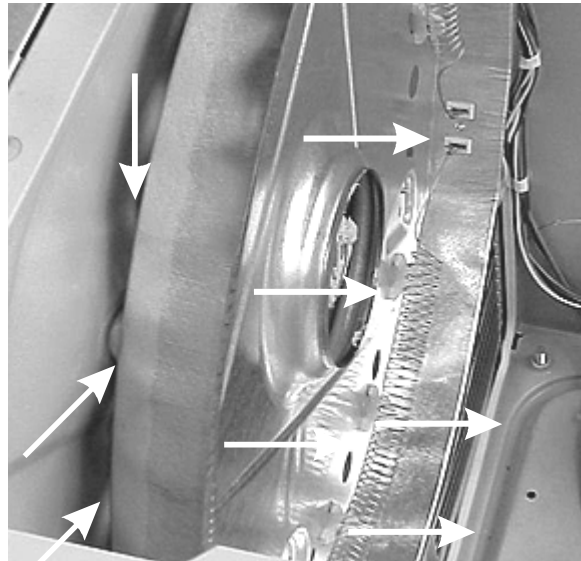

The air then is drawn into the drum through the holes in the rear of the drum.

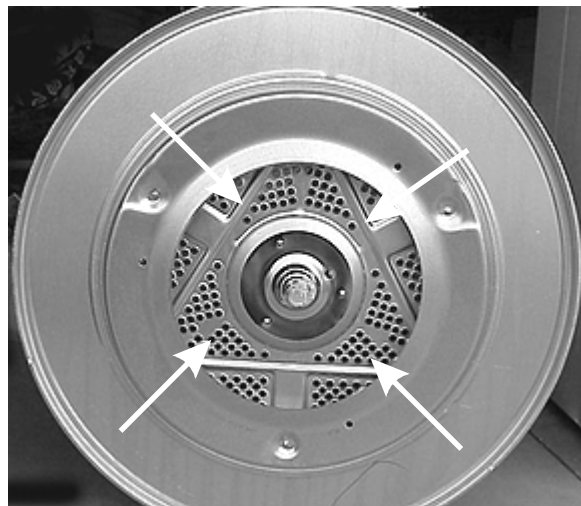

The air passes through the drum picking up moisture and is drawn through the lint filter into the ductwork at the

front of the dryer.

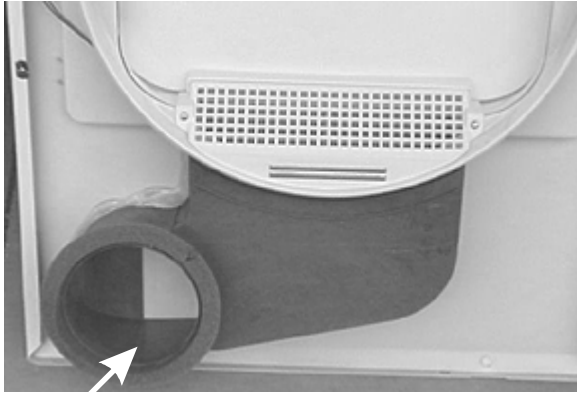

The air enters the fan housing and is pushed out the exhaust vent to the outside of the house.

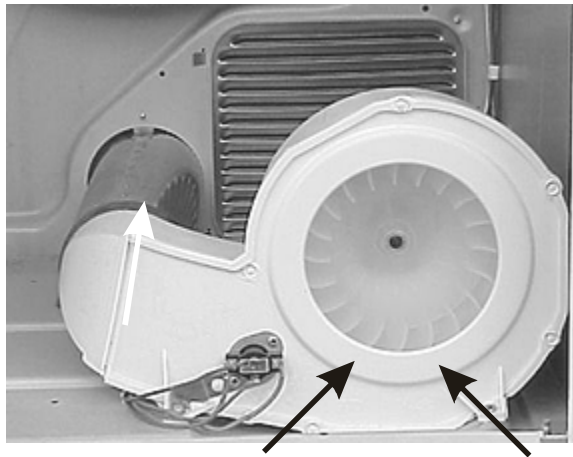

Airflow gas dryers:

The airflow in gas dryers is similar to electric dryers except for the heat source and the rear of the drum. The air enters the cavity through the louvered opening in the right rear corner of the dryer. The air is pulled across the gas burner, through the burner chamber and is ducted to the rear of the drum.

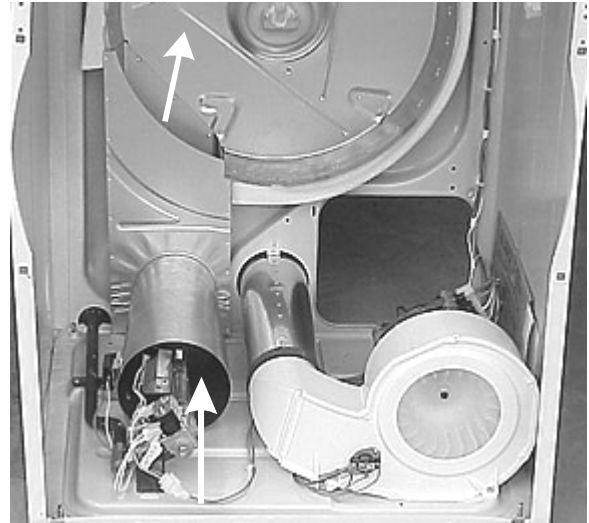

The drum is the same as in the electric dryer, except it does not have a heat baffle on it.

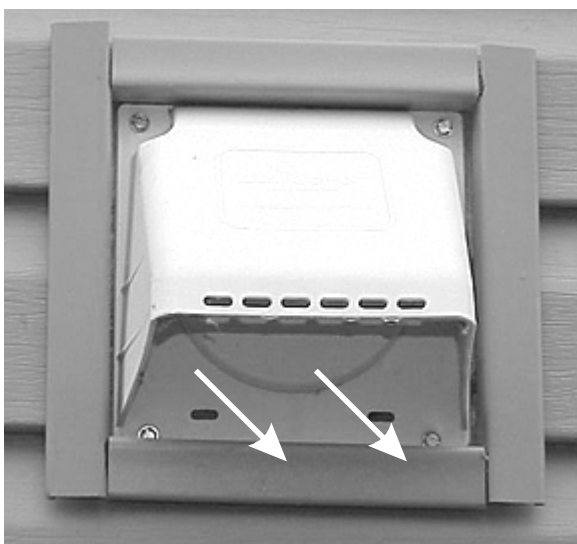

Airflow problems:

Airflow problems are usually caused by restrictions, leaks or short unrestricted vents resulting in longer drying times, hotter dryer surfaces and in extreme cases causing the thermal limiter to open on electric dryers.

Restrictions:

Restrictions can occur any place in the airflow system, but the most common are:

1. Installing the dryer in a small inclosed area; such as a closet without a louvered door that reduces the intake air.
2. Fan problems caused by either a slow running motor, a broken or deformed fan blade or a deformed fan housing.
3. A lint restriction in the lint screen area. Operator may not be cleaning the lint screen before using.
4. A restriction in the exhaust system in the house caused by the design of the vent, such as; the diameter of the vent pipe being too small, too long, too many right angles, or a collapsed or lint restricted vent pipe.

Note: Problems caused by the vent pipe in the house are not covered under the product warranty.

Air leaks:

Two types of air leaks may occur:

1. Air being drawn in around the door opening, between the drum and the front panel, or around the foam seal between the front duct and the blower housing, replaces some of the air being drawn through the drum and lowers the efficiency of the dryer.

Note: An air leak that occurs around the door opening or between the drum and the front panel usually will cause lint to build up on the inner panel of the door.

2. Air being pushed out around the blower housing or vent pipe inside the dryer, allows some of the moisture that has been removed from the clothes to be recirculated.

Short unrestricted vents:

The venting system in the dryer is designed to operate under some back pressure. This back pressure is needed to slow the airflow and allow the air to be heated before it passes through the clothes.

Note: With short direct vent runs; such as you have when the dryer is installed against an outside wall, use a 2 1/2" vent cap rather than a 4" vent cap.

Electrical Operation (Electric Dryers Models)

Note: Always refer to the wiring diagram or schematic with the product.

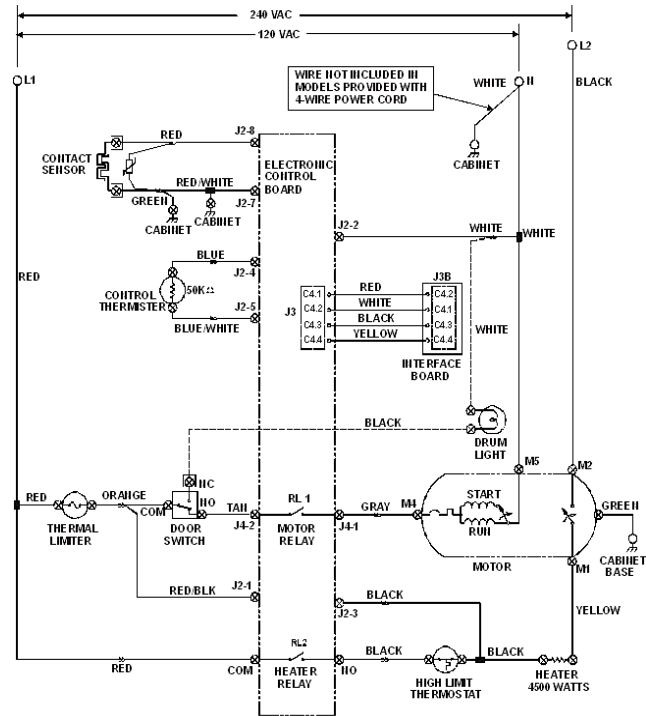

When the dryer is connected to electrical power, line 1 is connected to one side of the thermal limiter and the COM terminal of the heater relay RL 2 that is mounted on the electronic control board. Power is applied to the control board through thermal limiter to pin 1 of the eight pin plug. The electronic control board controls the operating temperature of the dryer and the length of the cycle by either sensing the amount of moisture in the clothes or a fixed amount of time when timed dry is used.

Note: For information on programming the electronic control and the cycles refer to section A.

Electronic Control Board Circuits:

Line 1 is applied to the control board at pin 1 of the eight pin plug and neutral on pin 2 of the eight pin plug. The control board receives inputs from the selector knob and push buttons which programs the control, the contact sensors that senses the amount of moisture in the clothes and the control thermistor which senses the temperature in the dryer. The control board uses these inputs to signal the interface board, control the drive motor circuit by opening and closing the contacts of relay RL 1 and the heater circuit by opening and closing the contracts of relay RL 2.

Drive Motor Circuit:

When power is connected to the dryer, line 1 is applied through the thermal limiter (a non-resettable fuse mounted on the rear wall of the dryer) to the COM. terminal of the door switch.

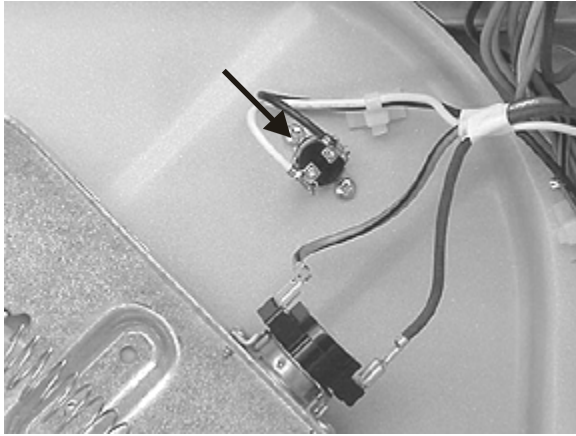

When the door is closed, the COM terminal is connected to terminal NO of the door switch. From terminal NO, power is applied to terminal J4-2 of the motor relay RL 1 on the control board. When the control board closes relay RL 1, power is applied through terminal J4-1 to terminal M4 of the drive motor.

Terminal M4 is connected inside the motor to one side of the thermal overload (The thermal overload protects the motor from being damaged by overheating.) The other side of the thermal overload is connected to one end of both the run winding and the start winding of the drive motor. When the motor is not turning, the other end of the start winding is connected internally to terminal M5 of the motor through the NC contact of the motor centrifugal switch. The other end of the run winding is also connected internally to terminal M5 which is connected to neutral.

When the motor is not turning, the start winding and the run winding are connected in parallel. When the contacts of relay RL 1 are closed, with the dryer door closed, line 1 and neutral voltage are applied across both the start and run windings of the drive motor. With power applied to both the start and run windings, the motor starts to turn.

When the speed of the motor reaches about 80% of its normal run speed, the contacts of the centrifugal switch remove power from the start winding thus removing the start winding from the circuit.

The drive motor performs two tasks in the dryer. A pulley, attached to one end of the motor shaft, uses a belt to drive the dryer drum. The blower wheel is attached to

the other end of the motor shaft to pull the air through the clothes and force it out the exhaust vent.

Temperature Sensing Circuit:

The temperature in the dryer is controlled by the control thermistor and the electronic control board. The control thermistor, mounted in the blower fan housing, is a negative coefficient thermistor that decreases in resistance as the temperature increases.

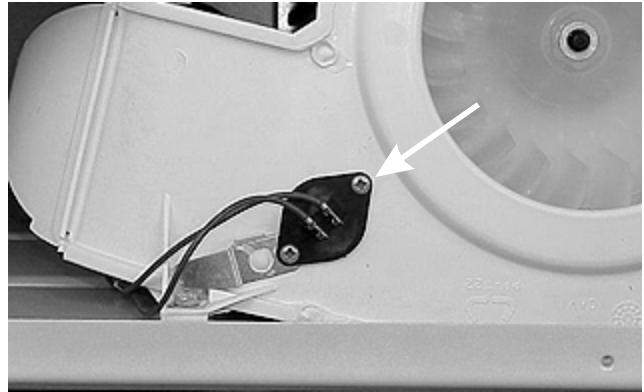

The electronic control board reads the resistance of the thermistor and converts it into temperature. It compares the reading from the thermistor to the temperature setting for the cycle.

The Heating Circuit:

The electronic control board applies power to the heating circuit through the contacts of heater relay RL 2. When the electronic control senses the temperature in the drum is below the programmed temperature, it closes the contact of RL 2. This applies line 1 power through the high limit thermostat that is mounted on the heating element assembly.

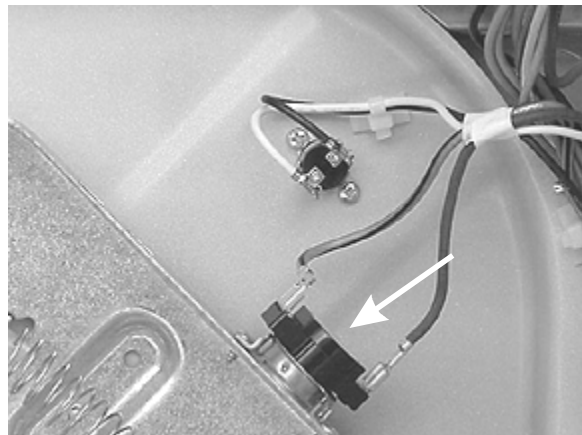

The high limit thermostat is a safety device that prevents the dryer from overheating if the contacts of the RL 2 fail closed. The contacts of the high limit thermostat, normally closed and are set to open at a temperature above the preset temperature specifications of the electronic control board. From the output terminal of the high limit thermostat, line 1 is connected to one side of the element and to pin 3 of the eight pin plug. The other side of the heating element is connected to line 2 through the contacts of the second centrifugal switch in the drive motor. This switch prevents power from being applied to the element if the motor is not running. The connection to pin 3 allows the control to monitor the contacts of the high limit thermostat. An error code will show if contacts open above a preset number of times in a cycle.

Drying Time:

The amount of drying time is determined in one of two ways: 1) A fixed amount of drying time may be set by turning the SELECTOR knob to one of the fixed drying times. 2) The AUTO DRY cycles a variable amount of time by the size of the load, the amount of moisture in the clothes and the dryness setting selected.

In the AUTO DRY cycles, the electronic control reads the capacitance between the two sensor bars located in the vent cover.



When wet clothes are placed in the dryer, the clothes touch the sensor bars and the moisture lowers the capacitance between the bars. As the dryer runs, moisture is removed from the clothes and capacitance between the bars increases. When the increase in capacitance satisfies the electronic control, the cycle status will change from "Auto Dry" to "Cool Down" and the load is tumbled without heat. At the end of cycle, the electronic control will turn the dryer off and the end of cycle signal will sound.

Electrical Operation (Gas Dryer Models)

Note: Always refer to the wiring diagram or schematic with the product.

Sample wiring diagram.

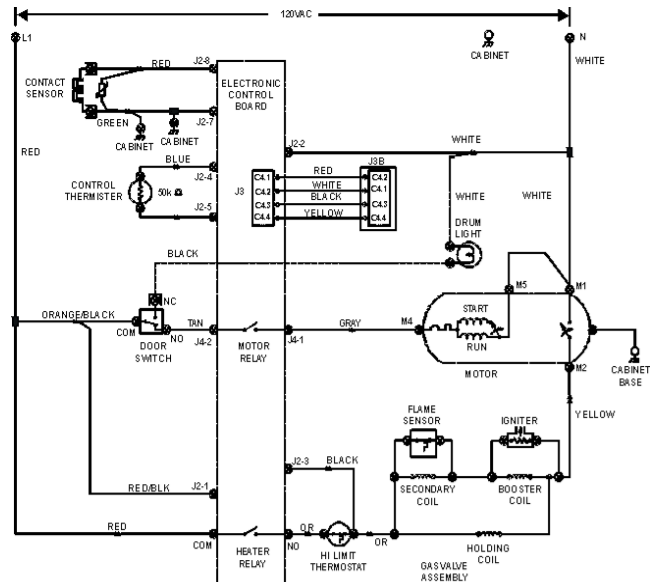

When the dryer is connected to electrical power, line 1 is connected to pin (1) of the eight pin plug of the control board, the terminal marked COM on the door switch and the COM terminal of the heater relay that is mounted on the electronic control board. Pin 1 of the eight pin plug provides power to the electronic control board. The electronic control board controls the operating temperature of the dryer and length of the cycle by either sensing the amount of moisture in the clothes or a fixed amount of time when time dry is used.

Note: For information on programming the electronic control and the cycles, refer to section A.

Electronic Control Board Circuits:

Line 1 is applied to the control board at pin (1) of the eight pin plug and neutral is connected on pin 2 of the eight pin plug. The control board receives inputs from the selector knob and push buttons which program the control, the contact sensors that senses the amount of moisture in the clothes and the control thermistor which senses the temperature in the dryer. The control board use these inputs to signal the interface board, control the drive motor circuit by opening and closing the contacts of relay RL 1 and the heater circuit by opening and closing the contracts of relay RL 2.

Drive Motor Circuit:

When power is connected to the dryer, line 1 is applied to the COM terminal of the door switch. When the door is closed, the COM terminal is connected to terminal NO of the door switch. From terminal NO, power is applied to terminal J4-2 of the control board to the motor relay RL 1 on the control board. When the control board closes relay RL 1, power is applied through terminal J4-1 to terminal M4 of the drive motor.

Terminal M4 is connected inside the motor to one side of the thermal overload (The thermal overload protects the motor from being damaged by overheating.) The other side of the thermal overload is connected to one end of both the run winding and the start winding of the drive motor. When the motor is not turning, the other end of the start winding is connected internally to terminal M5 of the motor through the NC contact of the motor centrifugal switch. The other end of the run winding is also connected internally to terminal M5 which is connected to neutral.

When the motor is not turning, the start winding and the run winding are connected in parallel. When the contacts of relay RL 1 are closed, with the dryer door closed, line 1 and neutral voltage are applied across both the start and run windings of the drive motor. With power applied to both the start and run windings, the motor starts to turn.

When the speed of the motor reaches about 80% of its normal run speed, the contacts of the centrifugal switch remove power from the start winding thus removing the start winding from the circuit.

The drive motor performs two tasks in the dryer. A pulley, attached to one end of the motor shaft, uses a belt to drive the dryer drum. The blower wheel, attached to the other end of the motor shaft, pulls the air through the clothes and forces it out the exhaust vent.

Temperature Sensing Circuit:

The temperature in the dryer is controlled by the control thermistor and the electronic control board. The control thermistor is mounted in the blower fan housing. The thermistor is a negative coefficient thermistor that decrease in resistance as the temperature increases.

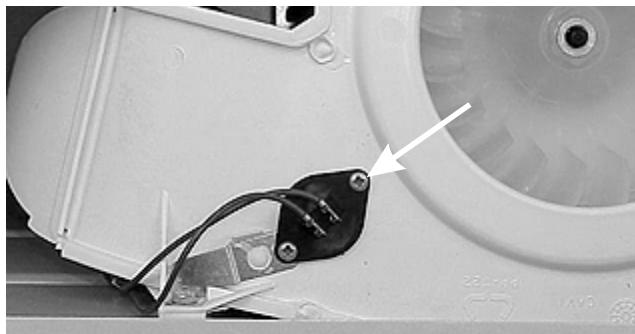

The electronic control board reads the resistance of the thermistor and converts it into temperature. The electronic control compares the reading from the thermistor to the temperature setting for the cycle and cycles the heating circuit accordingly.

The Heating Circuit:

The electronic control board applies power to the heating circuit through the contacts of relay RL 2. When the electronic control senses that the temperature in the drum is below the programmed temperature, it closes the contact of heater relay RL 2 applying line 1 to the high limit thermostat. The high limit thermostat is a safety device that prevents the dryer from overheating if the contacts of the relay RL 2 fail closed. The contacts of the high limit thermostat, normally closed, are set to open at a temperature above the preset temperature specifications of the electronic control board. From the output terminal of the high limit thermostat, line 1 is connected to pin 3 of the eight pin plug, one side of the holding coil of the gas valve, the secondary coil of the gas valve and the sensor that is mounted on the burner chamber.

The connection to pin 3 allows the control to monitor the contacts of the high limit thermostat and An error code will show if contacts open above a preset number of times in a cycle.

The holding coil, secondary coil, booster coil, sensor and igniter circuits interact with one another to assure safe operation of the dryer gas burner.

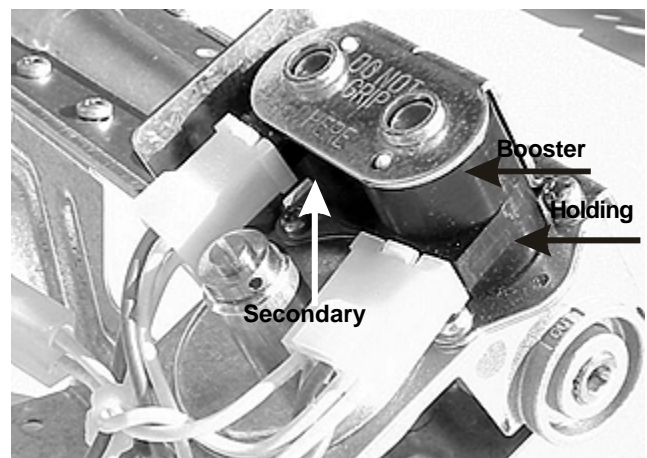

The gas valve has two chambers in series, both must be opened before gas will flow into the burner. The solenoid that controls the gas flow through the first chamber has two coils: the booster coil and the holding coil. The solenoid that controls the second chamber has one coil, the secondary coil.

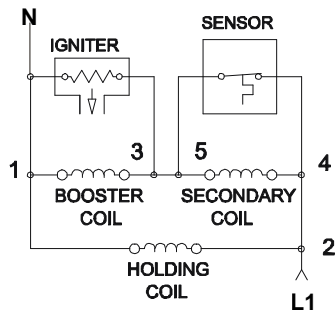

The other side of the holding coil, booster coil and igniter are connected to neutral through the second centrifugal switch in the motor (closed when the motor is running). When power is applied across these circuits, current flows through the holding coil, but the holding coil does not have enough magnetic force to open the solenoid by itself. At the same time, current flows through sensor contacts providing power to the booster coil and the igniter. When current flows through both the holding and booster coils, the first chamber opens. The contacts of the sensor are in parallel with the secondary coil. As long as the contacts of the sensor remain closed, current flow bypasses the secondary coil, and gas is prevented from flowing through the second chamber of the valve to the burner.

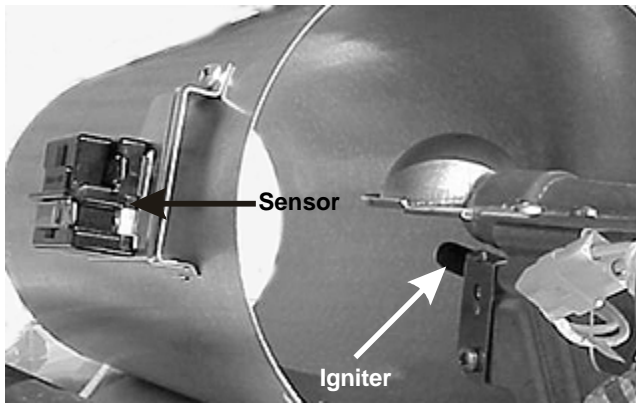

It is necessary to raise the temperature above 1100° F to ignite gas. As current flows through the igniter, the temperature of igniter raises from room temperature to approximately 1800° F within 30 seconds. The contacts of the sensor are heat sensitive and set to open above the ignition temperature of gas. When the sensor contacts open, current flows through the secondary coil, opening the second chamber, allowing gas to the burner, and is ignited by the heat of the igniter. When the contacts of the sensor are open, the parallel circuit formed by the igniter and the booster coil are in series with the secondary coil which lowers the current flow through the igniter and booster coil. Since it takes less magnetic force to hold a solenoid open than it does to open it, the

first solenoid remains open when the current through the booster coil is reduced. The reduction of current flow through the igniter reduces heat from the igniter but the sensor contacts are held open by the heat of the burner flame.

Drying Time:

The amount of drying time is determined in one of two ways: 1) A fixed amount of drying time may be set by turning the SELECTOR knob to one of the fixed drying times. 2) The AUTO DRY cycles a variable amount of time by the size of the load, the amount of moisture in the clothes and the dryness setting selected.

In the AUTO DRY cycles, the electronic control reads the capacitance between the two sensor bars located in the vent cover.

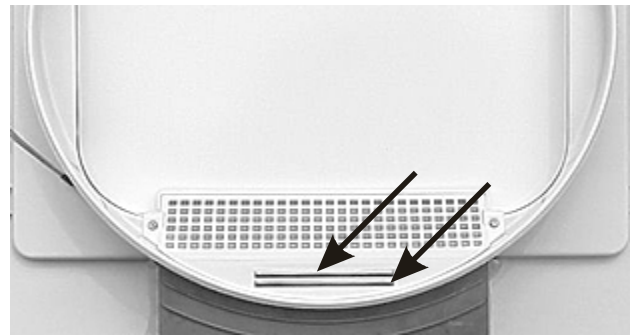

When wet clothes are placed in the dryer, the clothes touch the sensor bars and the moisture lowers the capacitance between the bars. As the dryer runs, moisture is removed from the clothes and capacitance between the bars increases. When the increase in capacitance satisfies the electronic control, the cycle status will change from "Auto Dry" to "Cool Down" and the load is tumbled without heat. At the end of cycle, the electronic control will turn the dryer off and the end of cycle signal will sound.

SECTION F - TROUBLESHOOTING

READING ERROR CODES

1. Press and hold the **Select** and **Cancel** buttons simultaneously for 6 seconds to reset control. The buzzer will sound 1 time and “*rES*” will be shown briefly in the display.
2. Immediately after, rotate cycle selector knob 2 turns counter-clockwise to the third position from the top, and then press and hold the **Select** and **Cancel** buttons simultaneously for 6 seconds. The control will enter Field Test Mode, the buzzer will sound 3 times, and the digital display will alternate between “*Fld*” and the firmware revision number (ex. “*r03*”).
3. Rotate the cycle selector knob 2 turns counterclockwise. The error code will appear in the digit display.

Troubleshoot problem by using chart below.

To move on to the next code, press the **Options** button.

To clear code, press the **Select** button. Code will be cleared when mode is exited.

To exit this mode, simultaneously press and hold the **Select** and **Cancel** buttons for 6 seconds.

NOTE: During normal operation, the display may show:

“*ad*” - dryer is in an auto dry cycle.

“*dn*” - cycle is done in auto dry.

“*PF*” - a power failure to the board has occurred.

“*Err*” - an error has been detected.

“*LOC*” - control lock is activated.

“*PAU*” - cycle has been interrupted.

Failure code chart

Failure code	Fault condition	Action
E 10	Communication failure.	Clear code, exit mode and start dryer. If the error persists, replace the control board.
E 11	Communication failure.	Clear code, exit mode and start dryer. If the error persists, replace the control board.
E 12	Communication failure.	Clear code, exit mode and start dryer. If the error persists, replace the control board.
E 24	Shorted control thermistor.	Remove wires from the control thermistor. Measure resistance of the thermistor. If the reading is not 50K (+/- 10%), replace thermistor. If the reading is within 50K (+/-10%) check wiring between thermistor and electronic control. If good, replace electronic control.
E 25	Open control thermistor.	Remove wires from the control thermistor. Measure resistance of the thermistor. If the reading is not 50K (+/- 10%), replace thermistor. If the reading is within 50K (+/-10%) check wiring between thermistor and electronic control. If good, replace electronic control.

Failure code chart

Failure code	Fault condition	Action
E4A	The drying time has exceeded program time for cycle.	Press Pause Cancel and SELECT buttons for 6 seconds to exit test modes. Position cycle selector to NORMAL, temperature selector to HIGH HEAT and touch START. Check for any thing that would extend dry times such as: no heat, restricted vent, blower fan blade broken or loose, dryer installed in closet with solid door, or bad connection in moisture sensor bar circuit or dirty bars. If dryer operates normally but code returns, replace electronic control.
E 5B	No heat.	Refer to flow chart dryer does not heat.
E 68	One of the keys (buttons) is stuck closed (active).	Enter function test mode and perform key (button) test to determine which button is at fault. Carefully free the and perform the test again. If button is free but the key struck code still exists, replace electronic control.
E 8C	High limit thermostat has trip to many times in a certain amount of time.	Check for blocked lint filter, blocked exhaust, air leaks around air duct, broken blower fan blades, worn or loose drum seals, dryer installed in closet with solid doors or door seal not correctly seated.
E AF	Microcontroller has been reset by Watchdog timer.	Clear code, exit mode and start dryer. If problem persists, replace electronic control.

TROUBLESHOOTING FLOW CHARTS

NOTE: Always check the wiring and pin/plug connectors before replacing any component.

NOTE: If a fault code is displayed the dryer will not operate.
Refer to page 8 for information on fault codes.

Electric dryer completely inoperative. _____	56
Gas dryer completely inoperative. _____	57
Electric and Gas dryers; blower motor runs but drum does not turn. _____	58
Electric and Gas dryers; longer than normal drying times. _____	58
Electric dryer not heating properly. _____	59
Gas dryer not heating properly. _____	60
Electric and Gas dryers; dryer over heating. _____	60
Electric dryers; blower motor runs but dryer does not heat. _____	61
Gas dryers; blower motor runs but dryer does not heat. _____	62
Electric and Gas dryers; clothes not dry in auto cycle. _____	63
Electric and Gas dryers; selector LEDs do not light. _____	64

Electric dryer completely inoperative.

Note: Always check wiring to the components.

Note: If a fault code is displayed, the dryer will not operate.

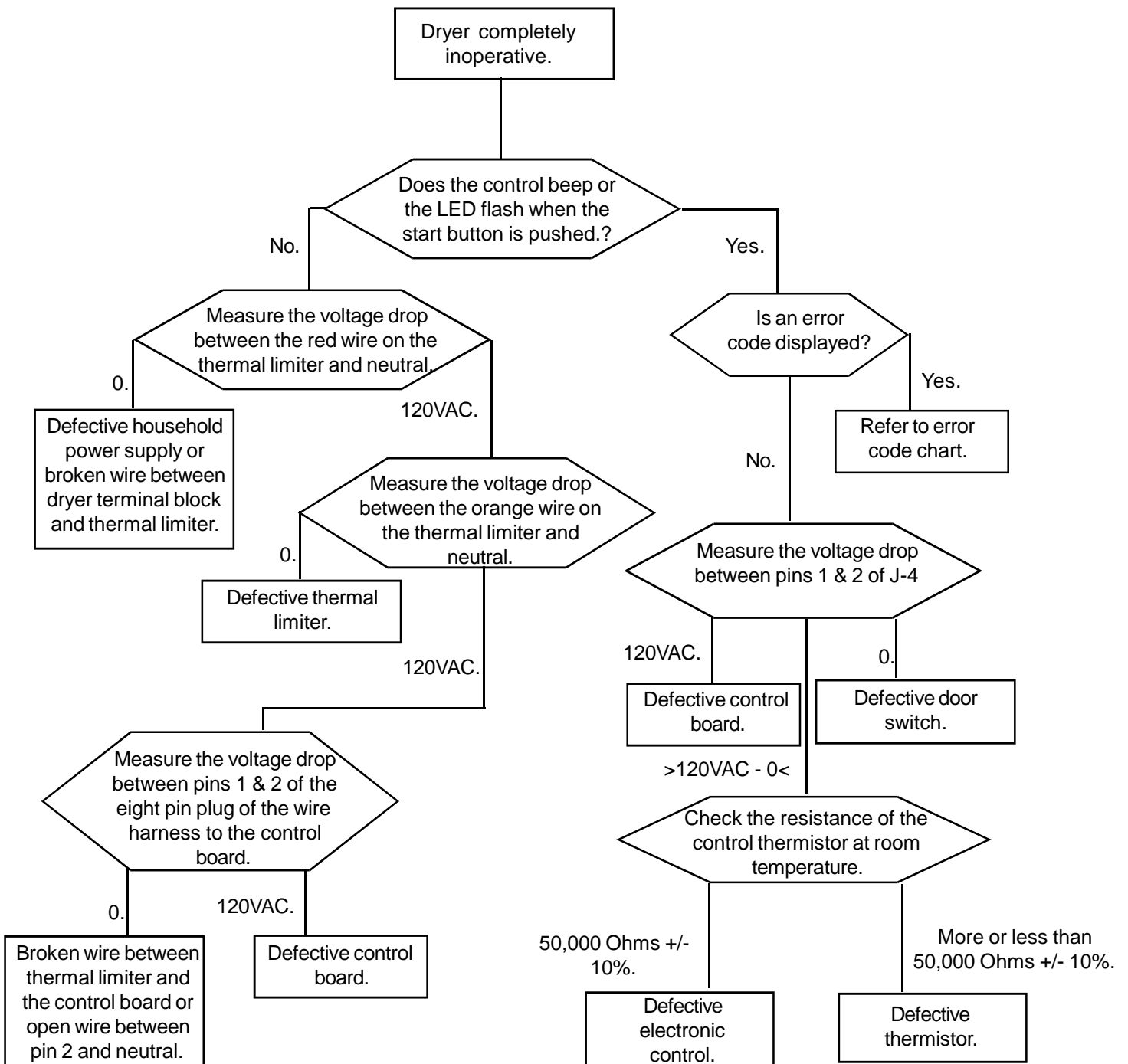

Gas dryer completely inoperative.

Note: Always check wiring to the components.

Note: If a fault code is displayed, the dryer will not operate.

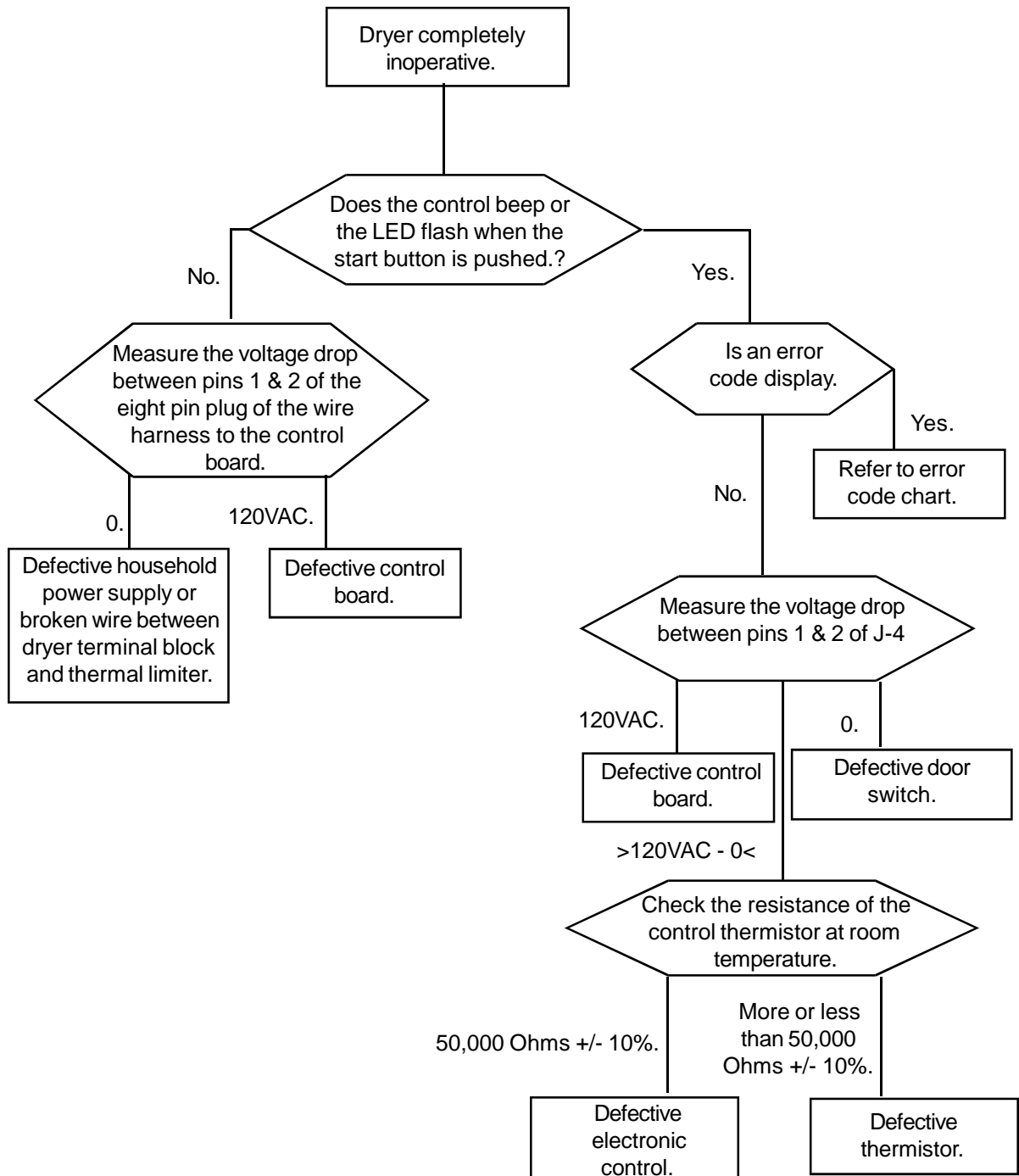

Electric and Gas dryers; blower motor runs but drum does not turn.

Note: Always check wiring to the components.

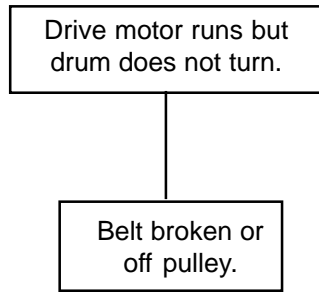

Electric and Gas dryers; longer than normal drying times. (Possible E 4A)

Note: Always check wiring to the components.

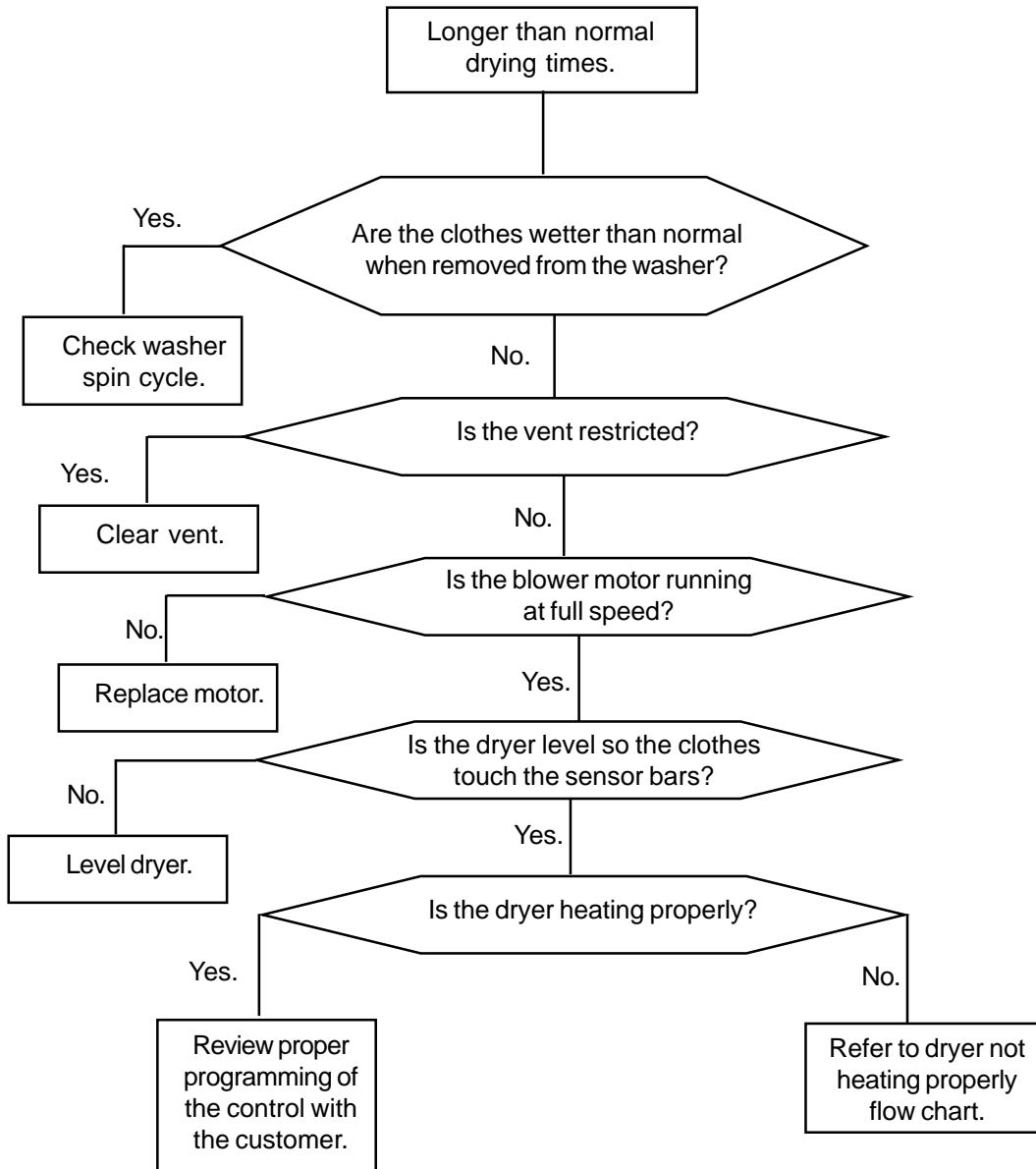

Electric dryers not heating properly (Possible E 5b)

Note: Always check wiring to the components.

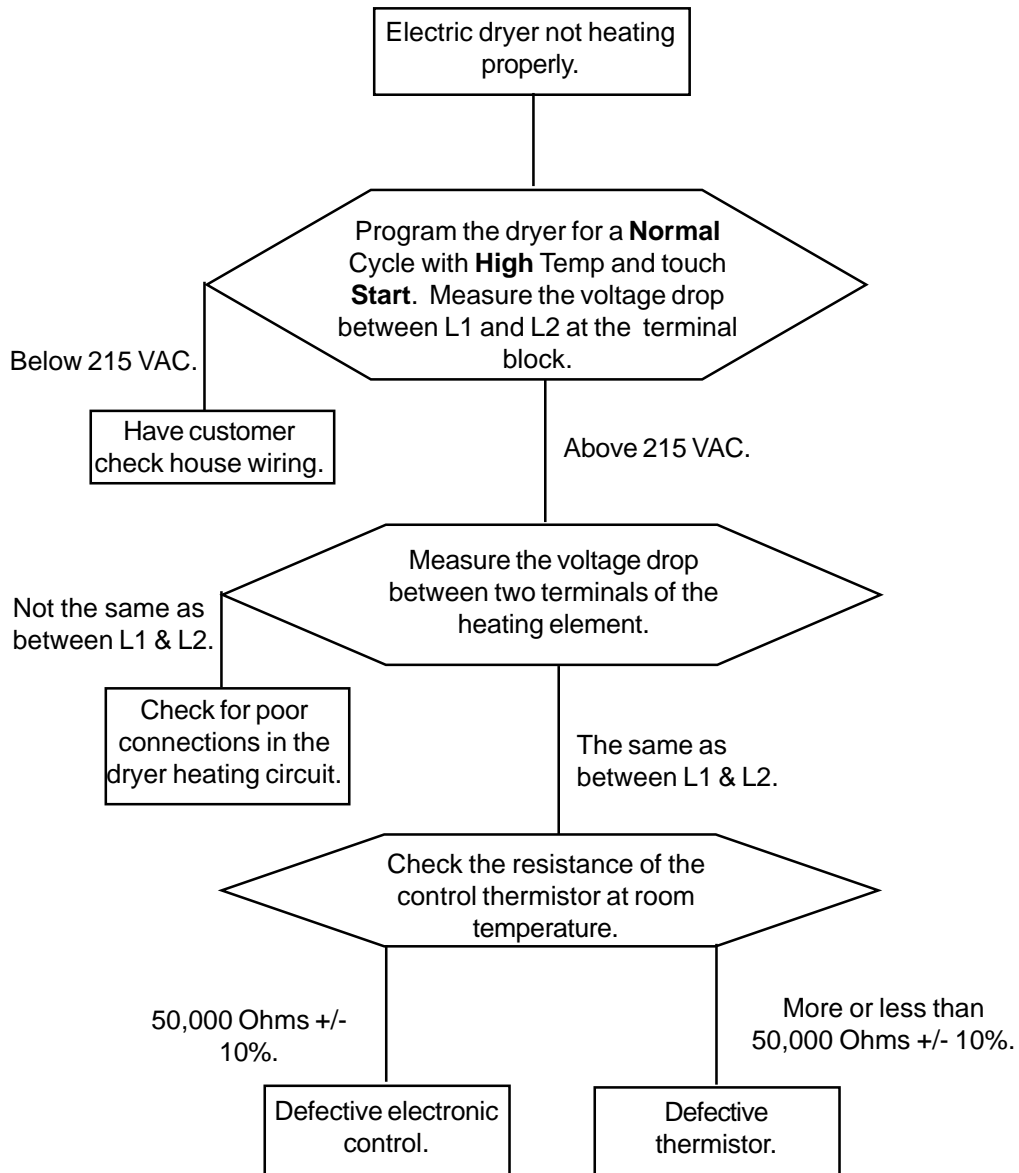

Gas dryers not heating properly. (Possible E 5b)

Note: Always check wiring to the components.

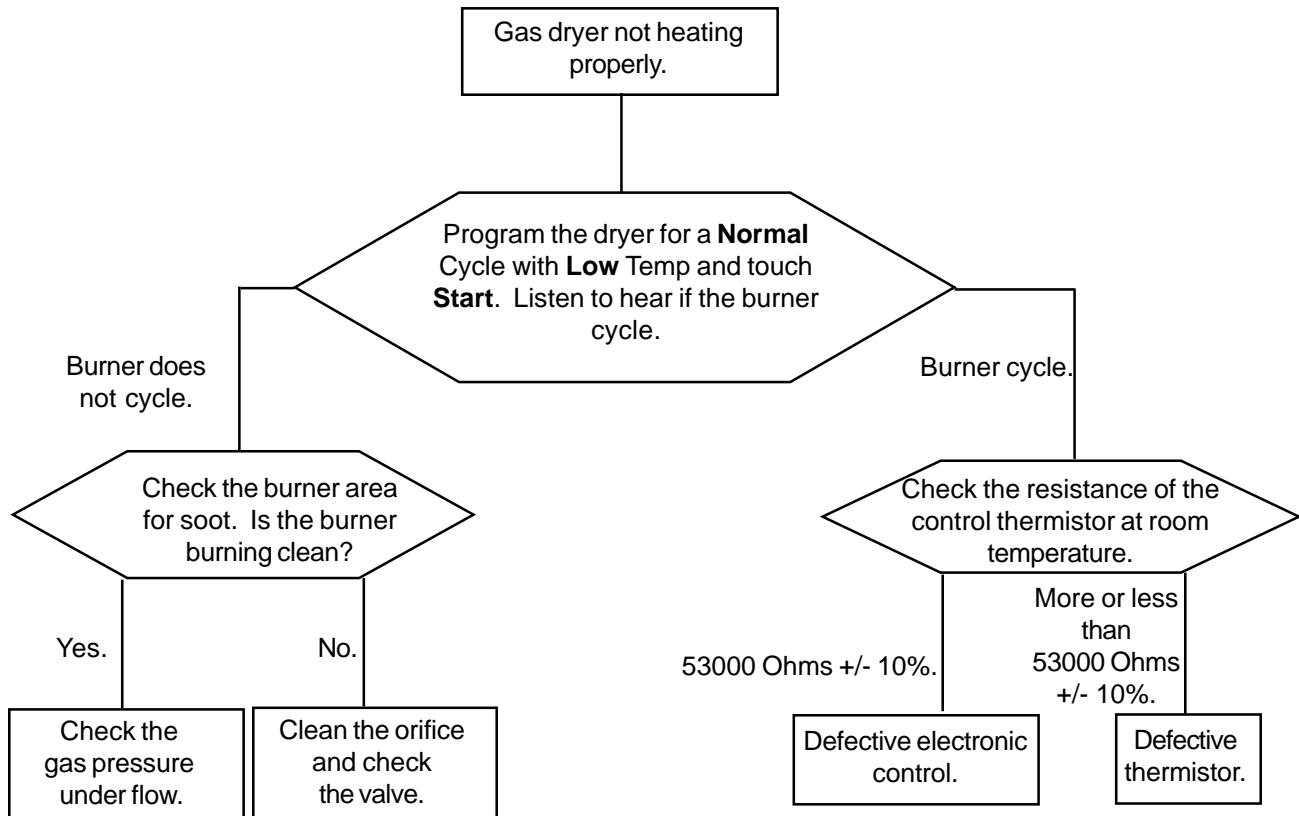

Electric and Gas dryers; dryer over heating. (Possible E 8C)

Note: Always check wiring to the components.

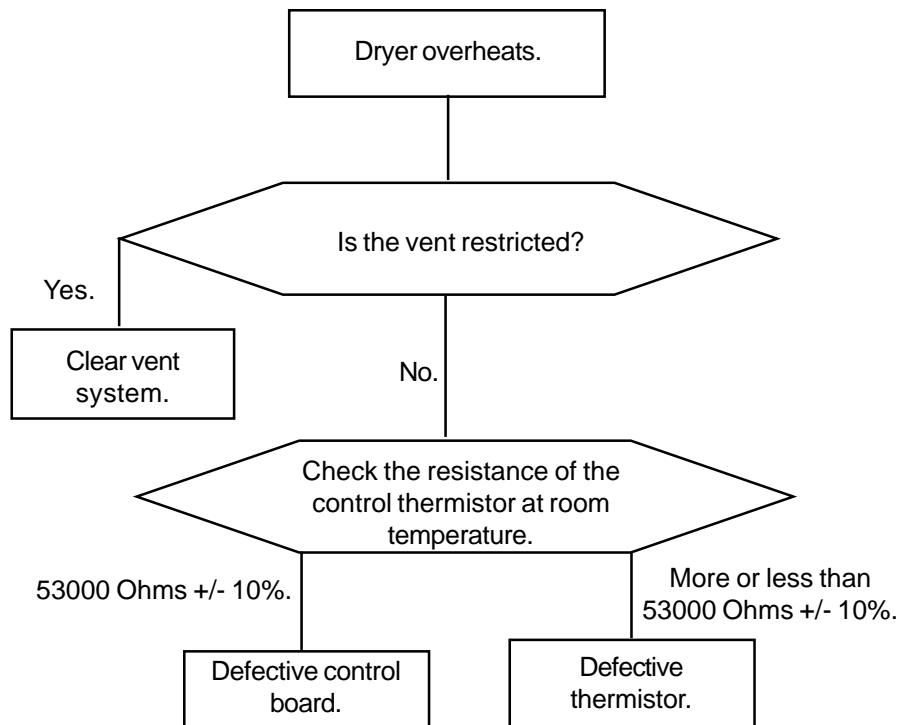

Electric dryers; drive motor runs but dryer does not heat.

Note: Always check wiring to the components.

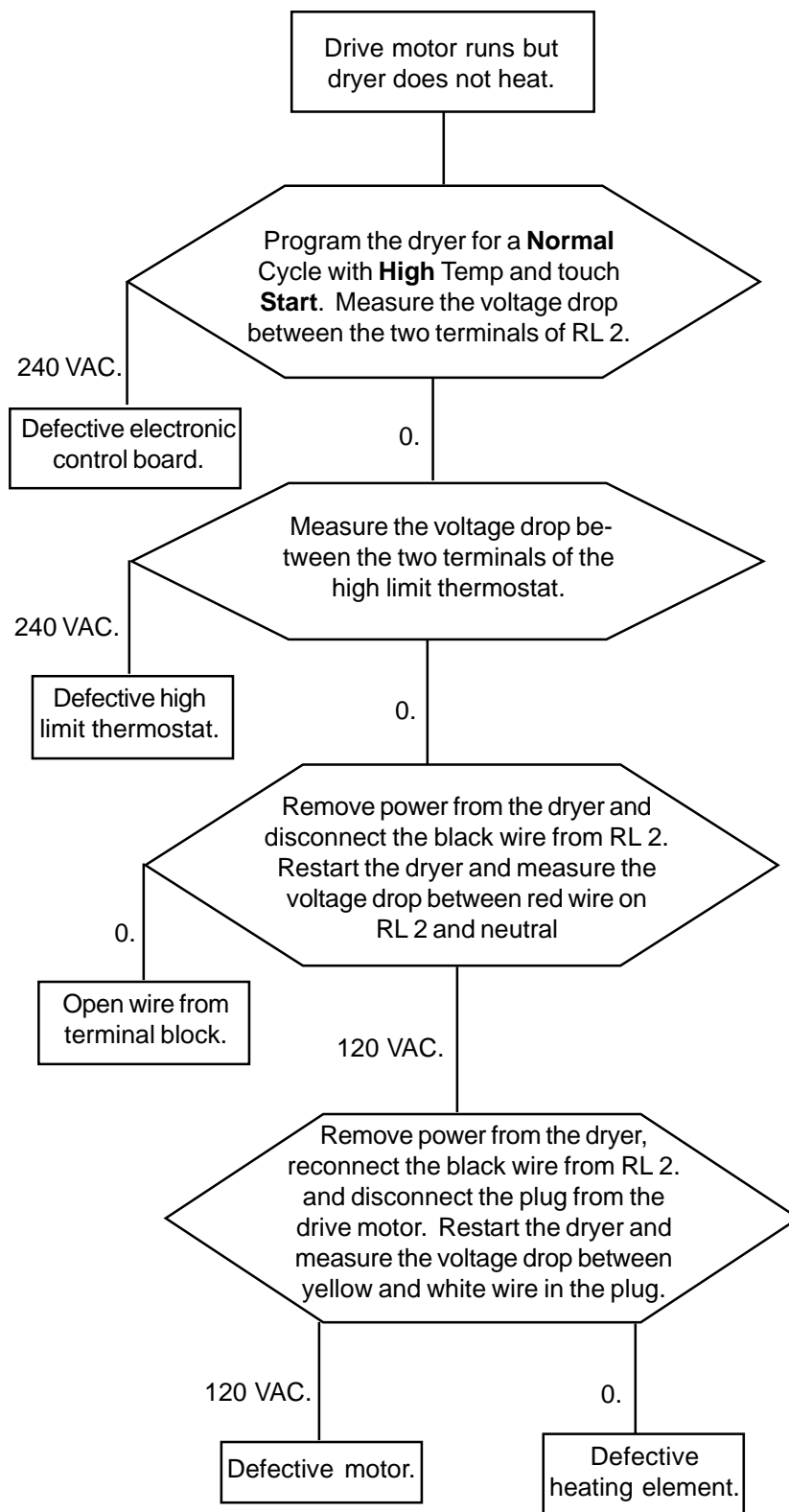

Gas dryers; drive motor runs but dryer does not heat.

Note: Always check wiring to the components.

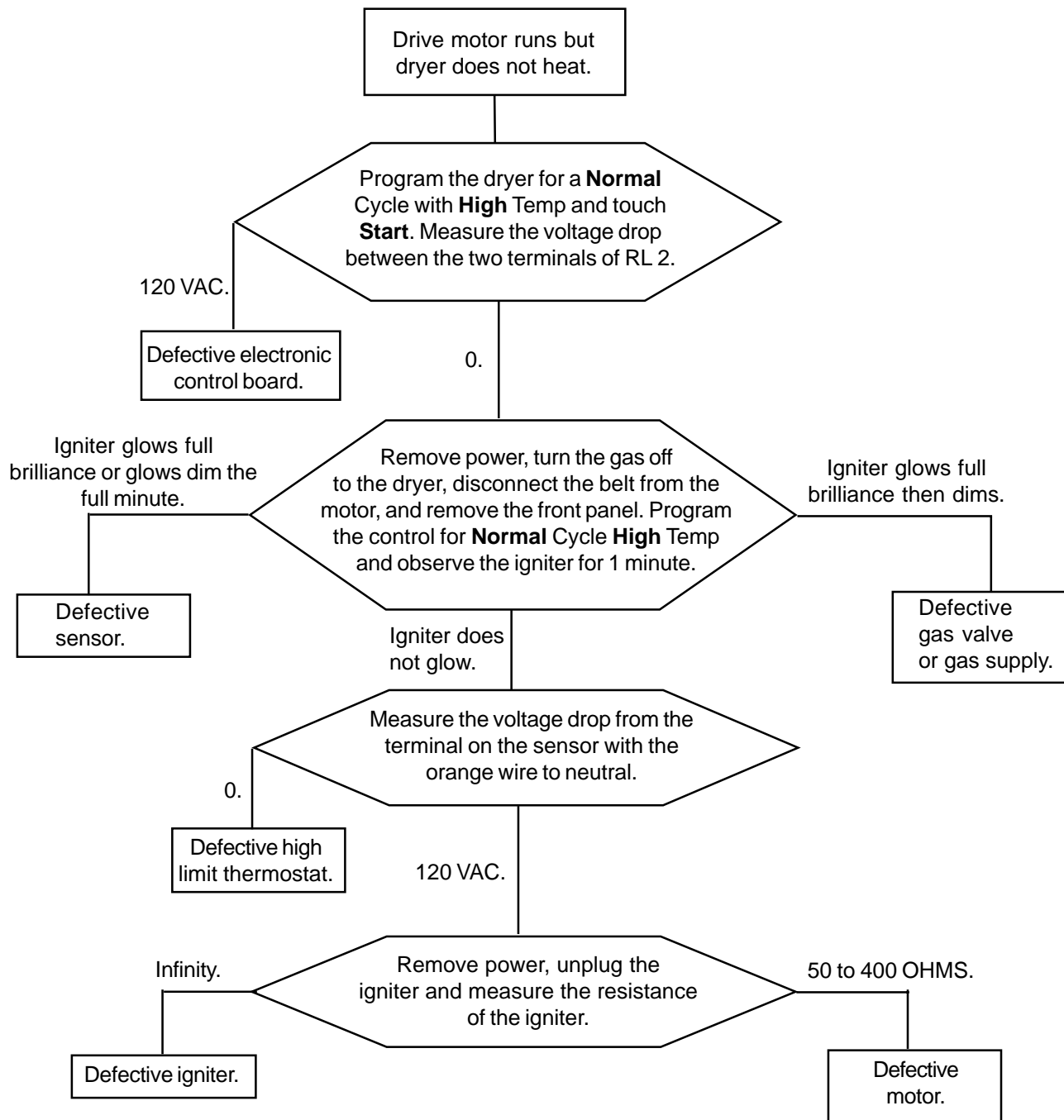

Electric and Gas dryers; clothes not dry in auto cycle.

Note: Always check wiring to the components.

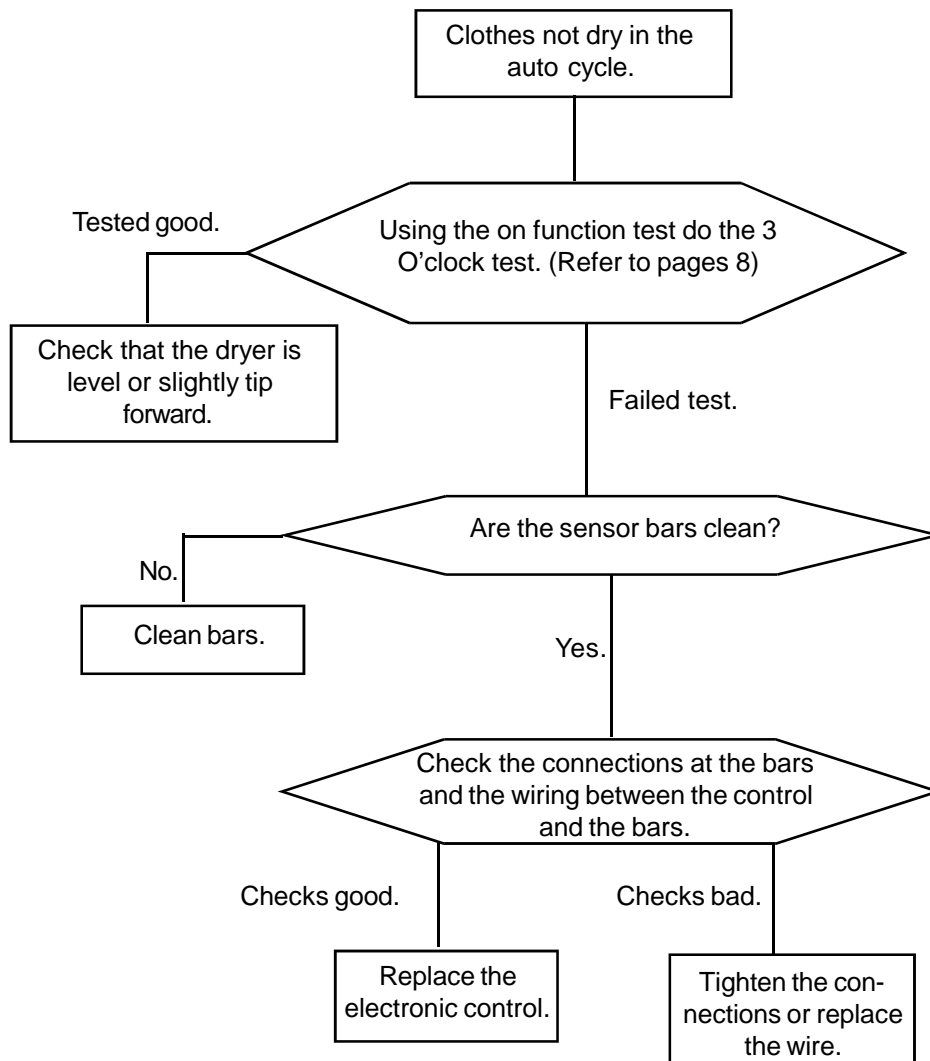

Electric and Gas dryers; selector LEDs do not light.

Note: Always check wiring to the components.

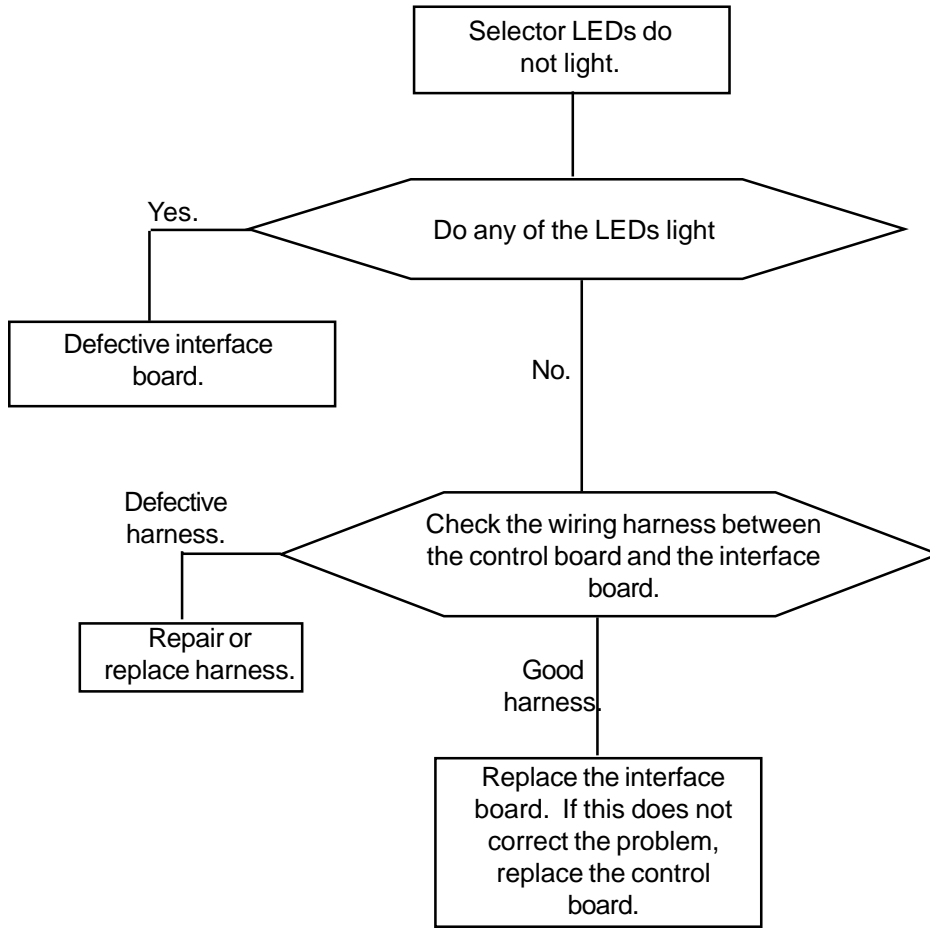

SECTION G - TEARDOWN

This section will describe how to remove components from both gas and electric dryers. Unless stated, the procedure will be the same on all dryers. Unless stated, reverse the procedure to reinstall the component.

⚠ WARNING Always remove electrical power from the dryer when working in an area where electrical power is present.

⚠ WARNING Always turn the gas off to the dryer before opening any gas piping.

Removing the top panel:

1. The top panel is held in place in the front by (3) plastic tabs on the console,



(2) metal tabs (one on each side),



and (2) screws in the rear.

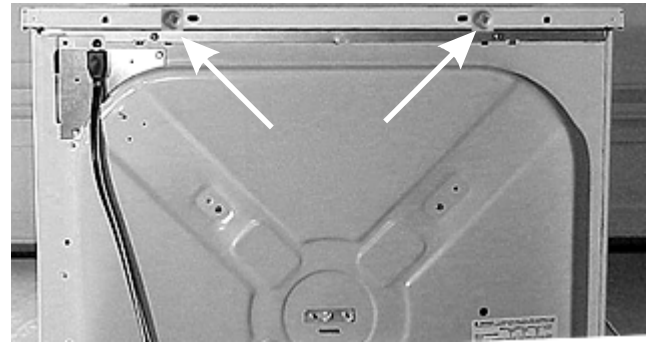

2. Remove the (2) screws, slide the top back about 1/2 inch and lift the top off.

Removing the console:

1. Disconnect the dryer from electrical supply and remove the top panel.
2. Remove the (4) screws, (2) on each side, holding the console to the front panel and roll the console forward.

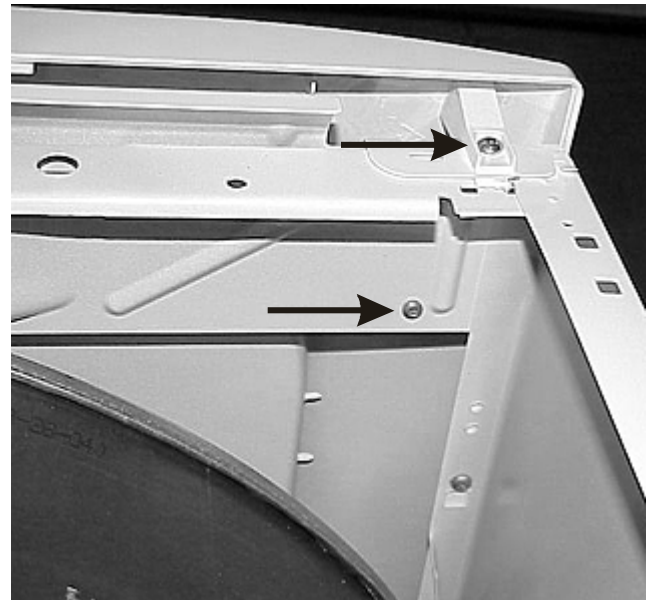

3. Disconnect the wiring from the control board and lift the console off.

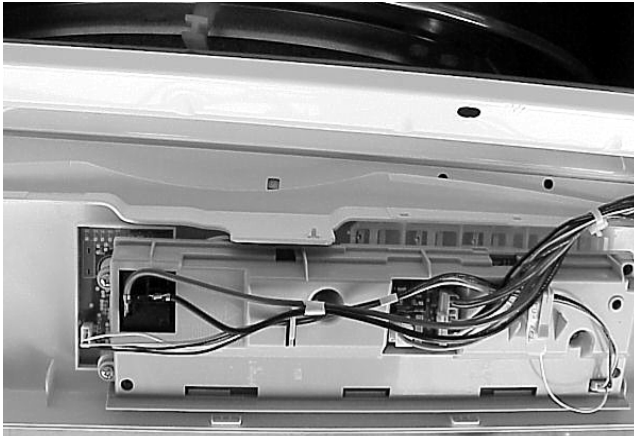

Removing the control board:

1. Disconnect the dryer from electrical supply and remove the top panel.
2. Remove the console.
3. Remove the (5) screws holding the control board to the console and lift to control off.

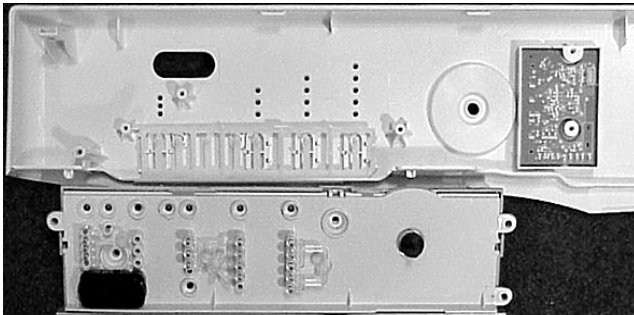
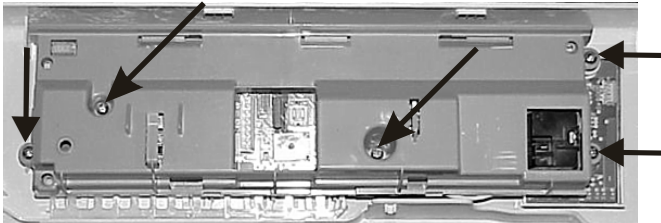

Removing the control board's rear cover:

1. Disconnect dryer from the electrical supply and remove the control board.

2. Release the two locking tabs and roll the cover off of the control.

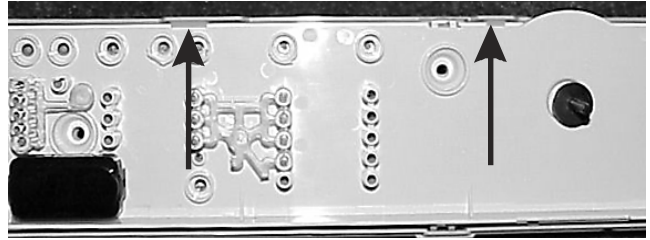

Removing the interface board:

1. Disconnect dryer from the electrical supply and remove the control board.
2. With the control board removed, the interface board will lift out.

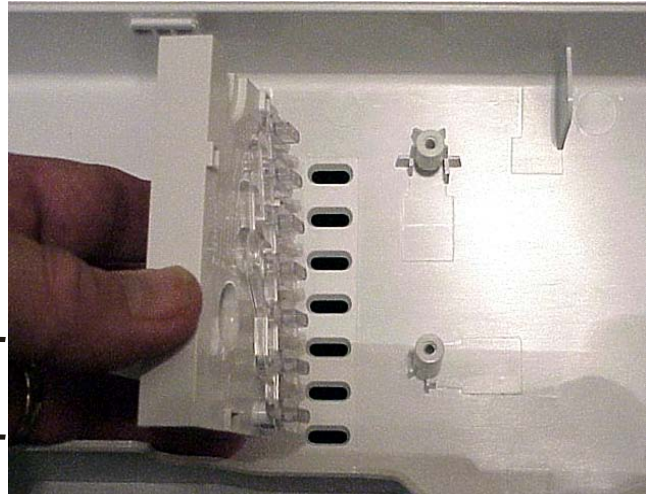

Removing the selector knob:

1. Disconnect dryer from the electrical supply and remove the control board.
2. Using a pair of needle-nose pliers, squeeze the shaft of the selector knob and pull it out the front.



Removing the button spring:

1. Disconnect dryer from the electrical supply and remove the control board.
2. Release the locking tab and lift the spring up and out.

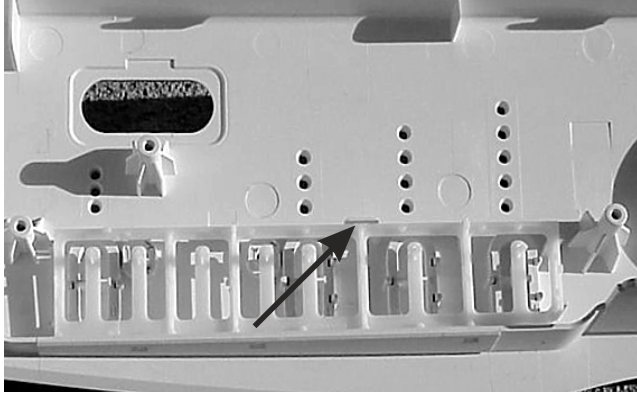

Removing the buttons:

1. Disconnect dryer from the electrical supply and remove the control board and the button spring.
2. With the button spring removed, the buttons will lift out.

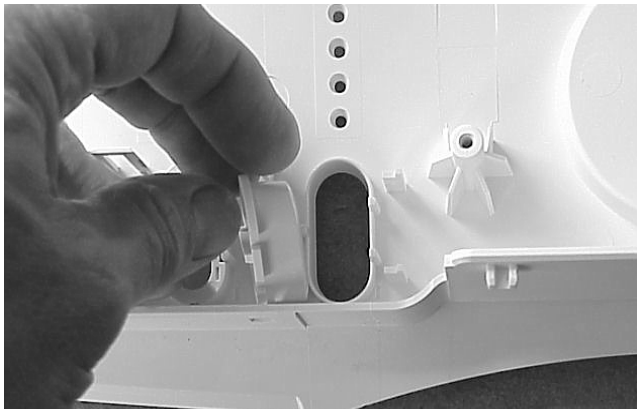

Removing the loading door:

Note: To remove the two screws holding the hinge of the door to the front panel, use a small ratchet with a #2 square bit or a right angle Phillips screwdriver.

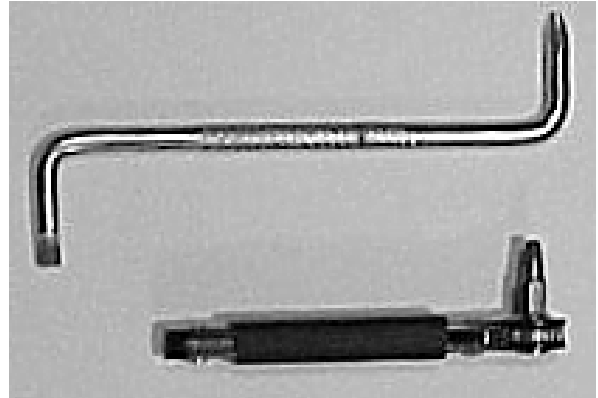

1. Open the dryer door.
2. Remove the (2) screws that secure the hinge to the front panel. **NOTE:** Remove the bottom screw first. Support the door assembly firmly before removing the top screw.

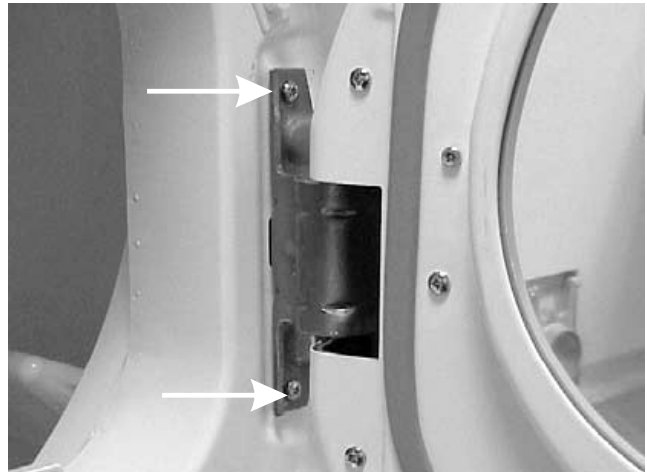

3. Remove the door assembly by lifting and pulling outward from unit.
4. Place door assembly face down on a soft flat surface.

Disassembling the loading door:

1. Remove the (7) screws that attach the inner door assembly to the outer door assembly. Lift the inner door assembly out of the outer door assembly.

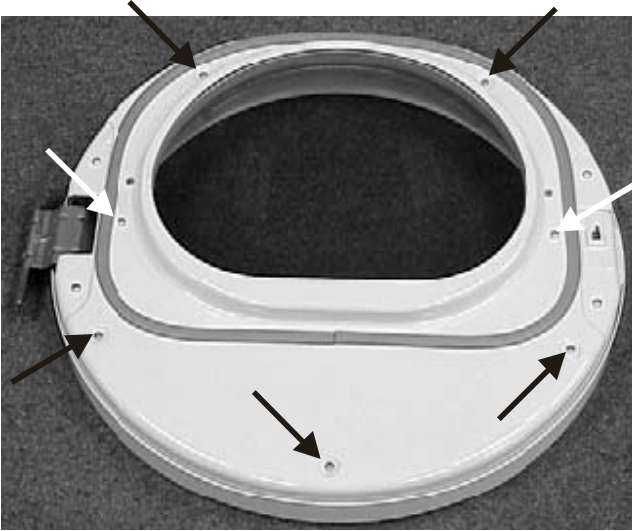

2. To remove the frame holding the outer lens in place, release the three locking tabs holding the frame to the outer door panel and lift the frame off.



3. With the frame removed, lift the outer lens out.

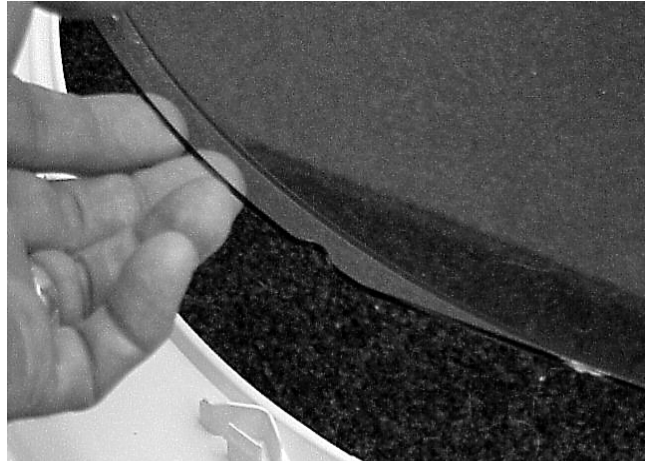

4. To remove the hinge assembly, remove the (3) screws holding the hinge assembly to the inner door panel and lift the hinge assembly out.

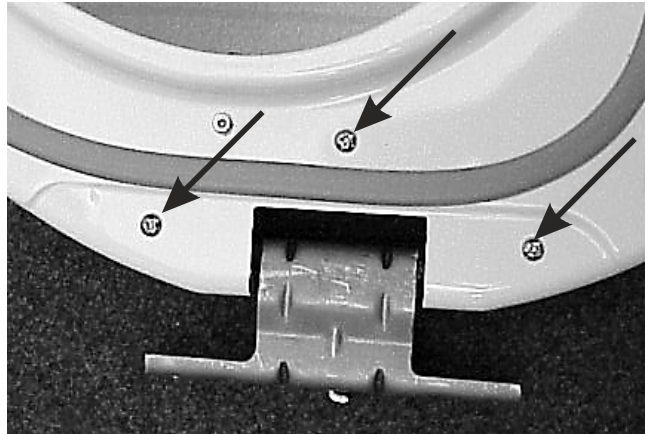

5. To remove the door seal, use a small common screw driver from the back of the inner door panel and work the locking tabs of the door seal through the panel.

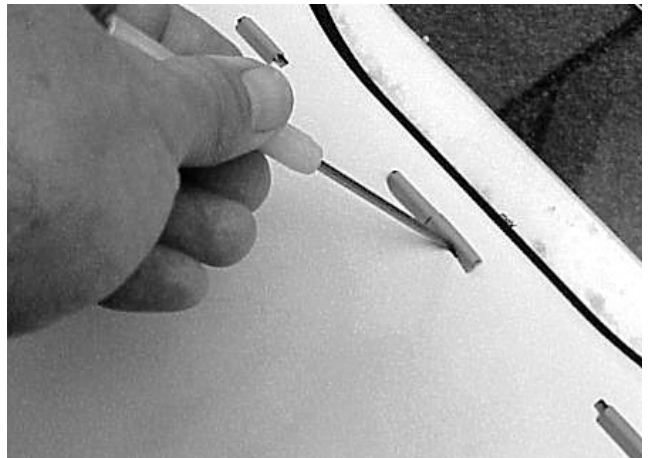

Note: If the door seal is to be replaced, the door seal can be pulled off from the front and the new door seal can be installed without taking the door part.

6. To remove the door strike, squeeze the rear of the strike with a pair of pliers and push the strike out the front of the inner door liner.

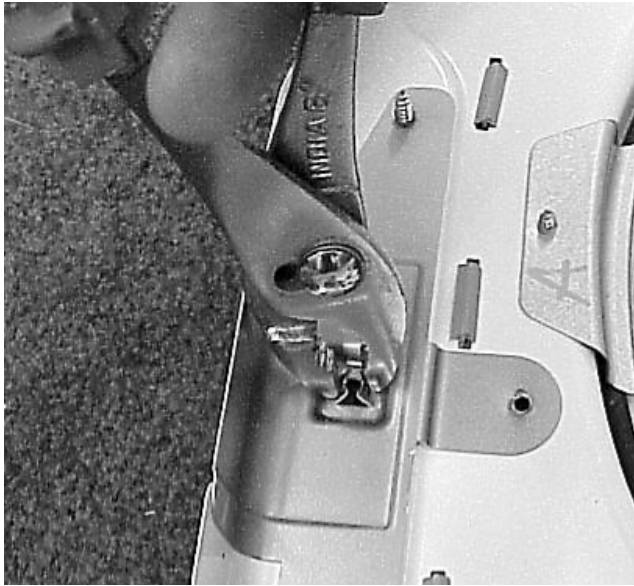

To remove the inner door glass, remove the (2) tamperproof screws one at each end of the glass and lift the glass out.

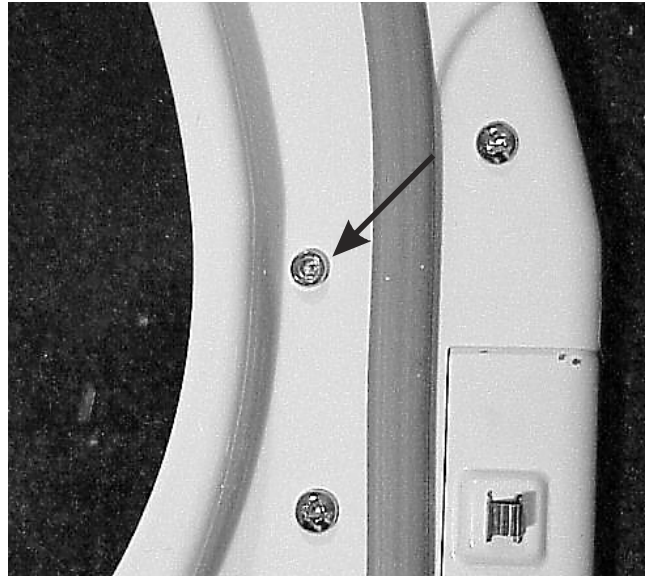

7. To remove the door strike bracket, remove the three screws holding the bracket to the inner liner and lift the bracket out.

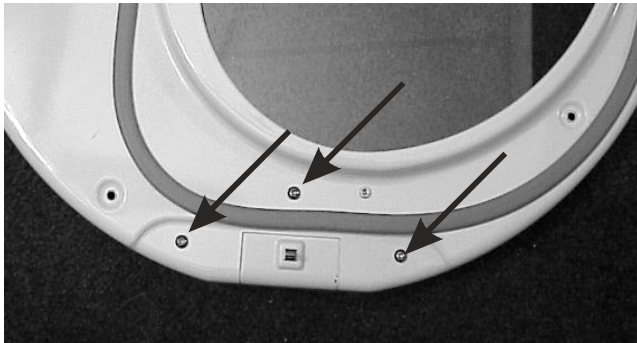

9. The rubber seal around the glass will lift off. When reinstalling the glass, be sure that the rubber seal does not roll.

Removing the catch plate:

1. Open the loading door and remove the (2) Phillips screws holding the door latch assembly to the front panel.

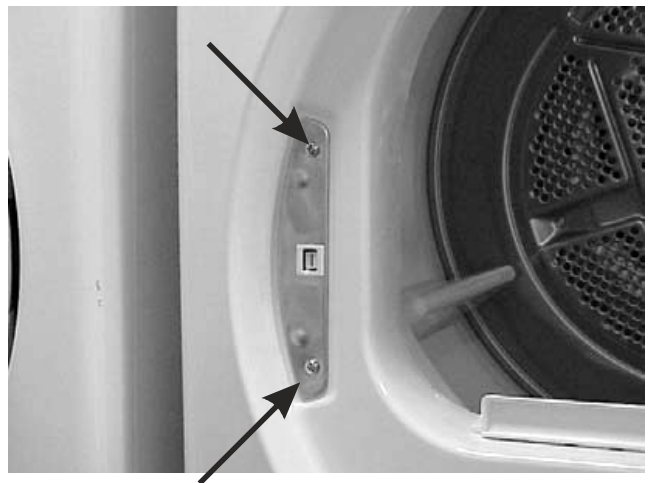

8. The inner door glass is held to the inner liner by (2) metal clamps, (1) at each end.

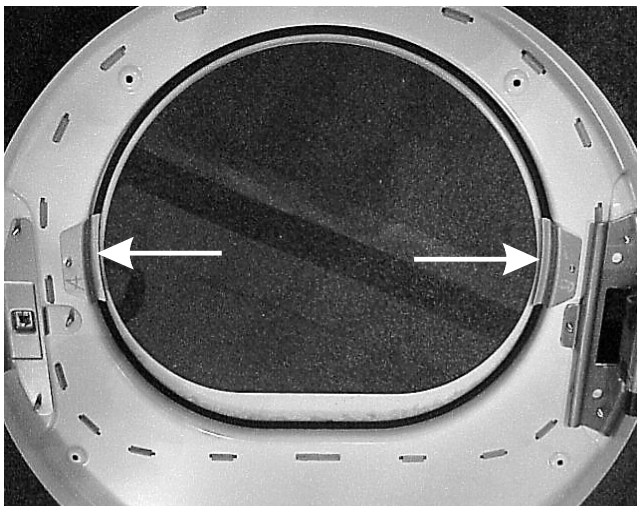

Removing the catch:

1. Open the loading door and remove the catch plate.

2. Use a pair of pliers and push the catch forward until the two metal prongs on the catch hits the catch plate.

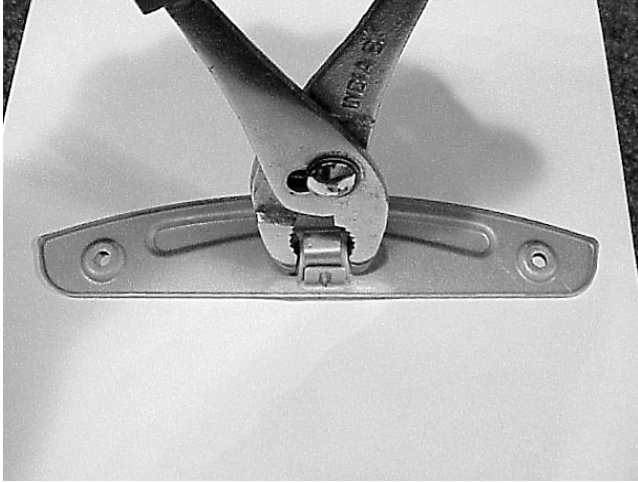

3. Using a small screwdriver, push down on the metal prongs to release the catch out the front.

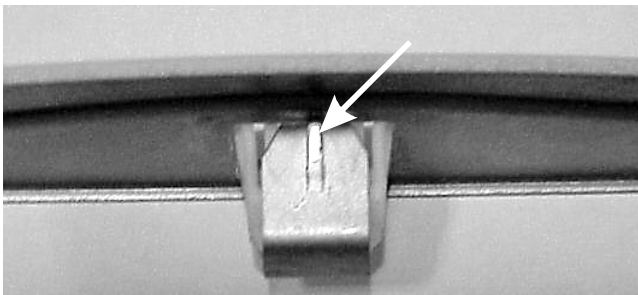

Removing the door switch:

1. Disconnect the dryer from electrical supply, open the door and remove the top.
2. Disconnect the wires from the door switch.
3. Squeeze the release tabs on the ends of the switch and push it out the front.

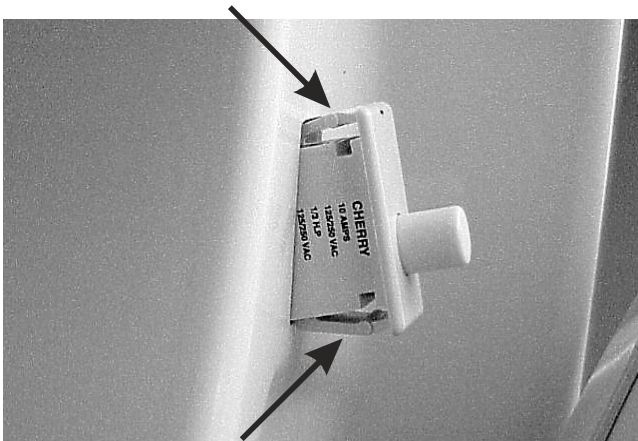

Removing the front panel:

1. Disconnect the dryer from electrical supply and remove the console.
2. Remove the (2) screws, one on each side, at the bottom holding the front panel to the bodysides.

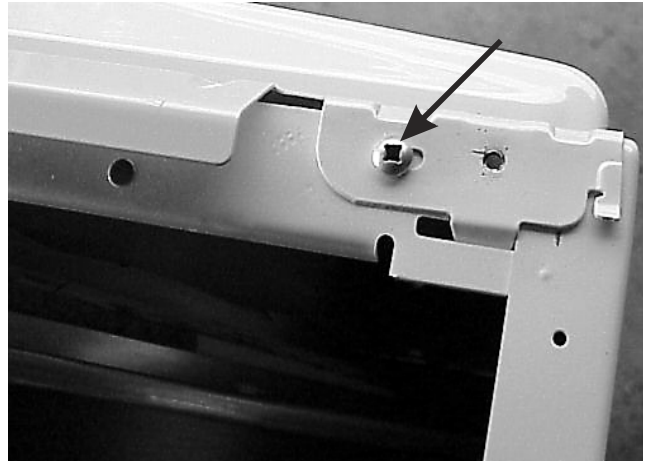

3. Raise the front of the dryer and remove the (2) screws holding the bottom of front panel to the dryer base.

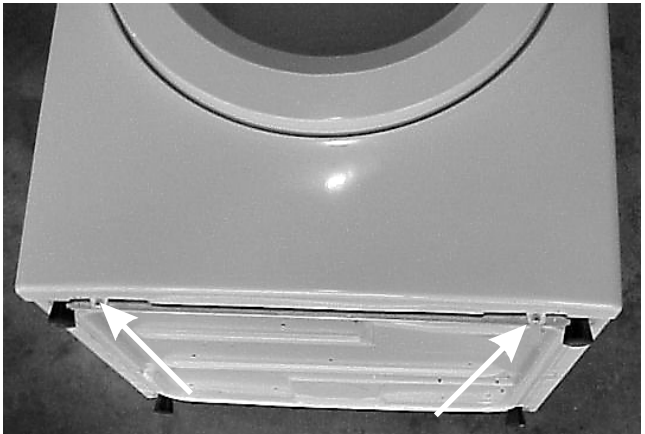

4. Pull out on the bottom of the front panel to release the spring loaded tabs.



5. Lift up on the front panel to release the (2) tabs at the top, one on each end, and swing the panel out.

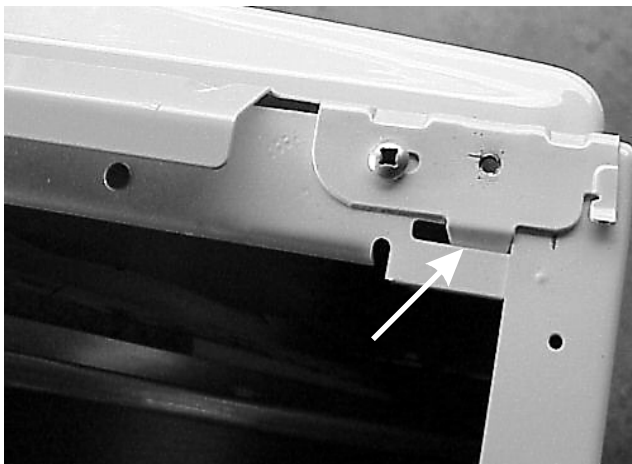

6. Disconnect the wiring from the drum light, door switch, the ground wire, and unplug the wiring harness from the sensor bars.

Replacing the sensor bars:

1. Disconnect the dryer from electrical supply.
2. Open the dryer door and remove the lint screen.

3. Remove the (2) screws holding the vent grill to the front panel.

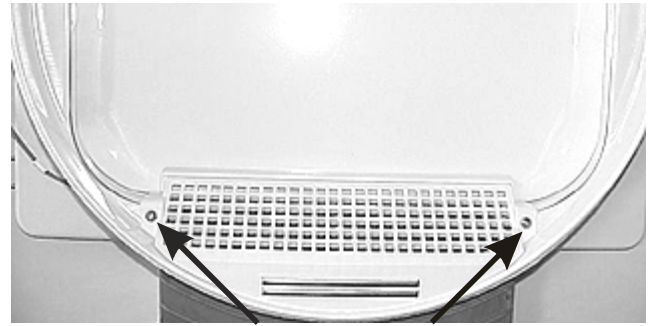

4. Pull the grill into the drum and disconnect the wires.

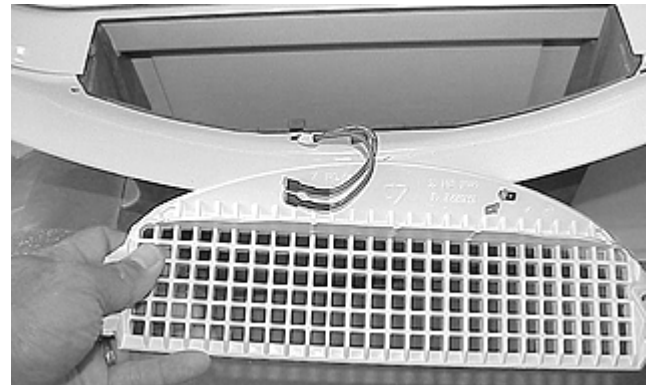

Replacing the front panel air duct:

1. Disconnect the dryer from electrical supply and remove the front panel.
2. Remove the (2) screws holding the vent grill to the front panel.
3. Release the sensor wire harness and pull down to remove the air duct.

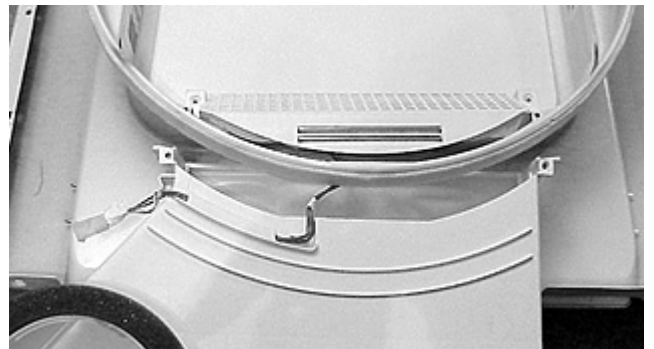

Replacing the drum light bulb:

1. Open the dryer door, release the clip holding the light shield by pushing up, and unscrew the 7 watt incandescent bulb.

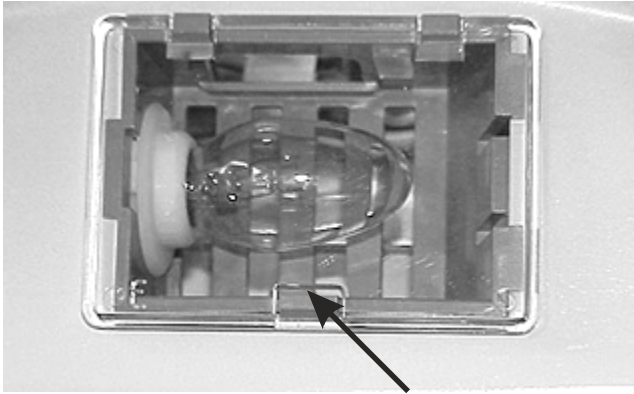

Replacing the drum light housing:

1. Disconnect the dryer from electrical supply.
2. Remove the top, lean the top of the front panel forward and disconnect the wires from the light socket.
3. Push in to release the tab at the end of the housing and push the housing into the drum.

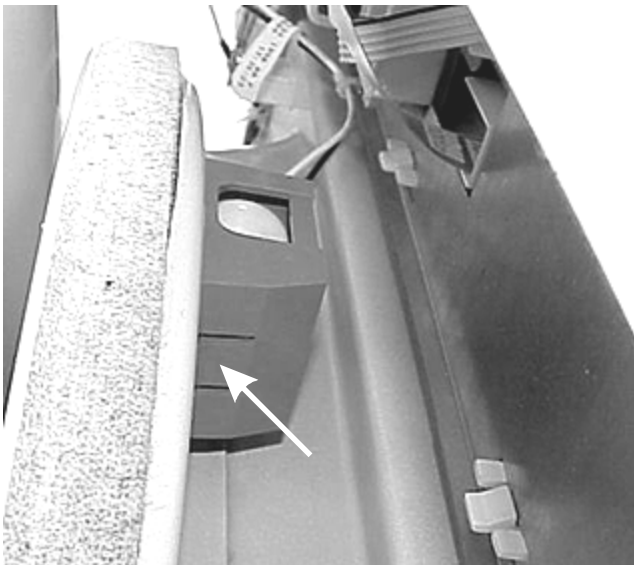

Replacing the drum light socket:

1. Disconnect the dryer from electrical supply.

2. Remove the top and disconnect the wires from the light socket.
3. Remove the light bulb, squeeze the tabs on the side of the socket and push the socket into the housing.

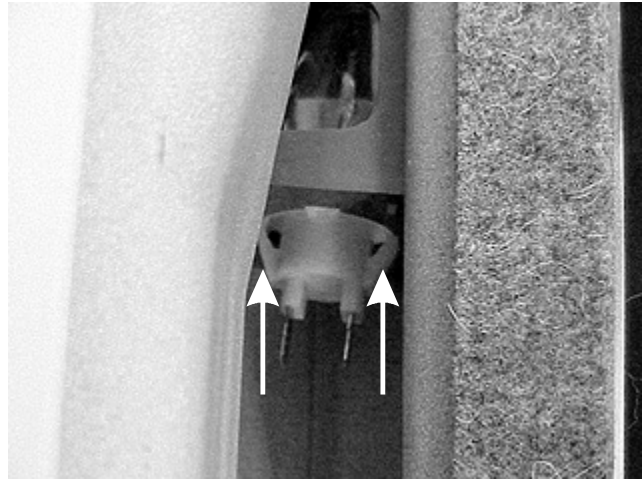

Replacing the felt seal:

1. Disconnect the dryer from electrical supply.
2. Remove the front panel.
3. The felt seal, a (2) piece seal that is glued to the front panel rim, is what the drum rides on.
4. To replace the seal, pull the old seal off and glue the replacement to the rim.

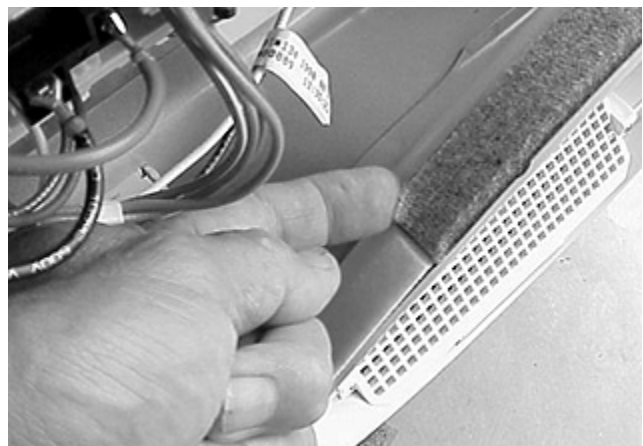

Replacing the foam seal:

1. Disconnect the dryer from electrical supply.

2. Remove the front panel.

3. The foam seal, glued to front panel duct, provides a seal between the front panel duct and the blower.
4. To replace the seal, pull the old seal off and glue the replacement to the duct.

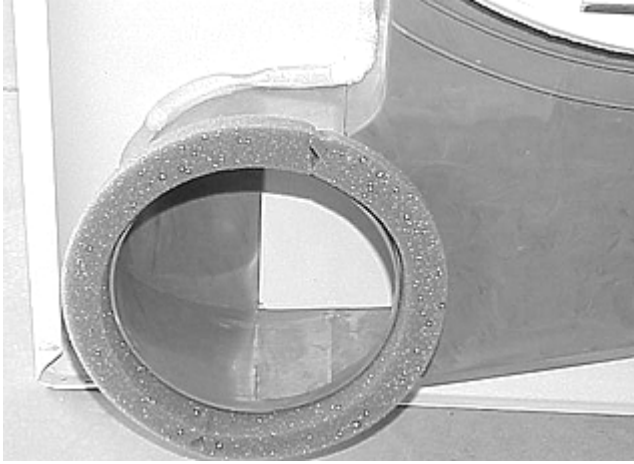

2. Push the idler pulley to the right and slip the belt off the motor pulley.

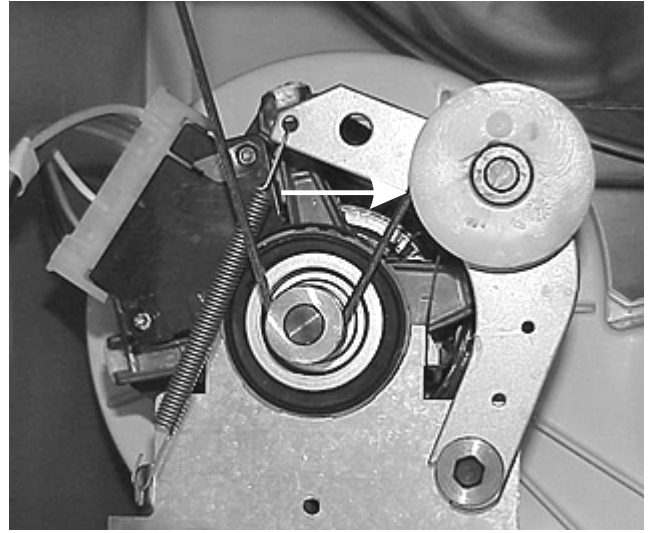

Removing the rear access panel:

1. Remove the (2) screws holding the access panel to the rear panel and swing the left side of the panel out to disengage the tabs.

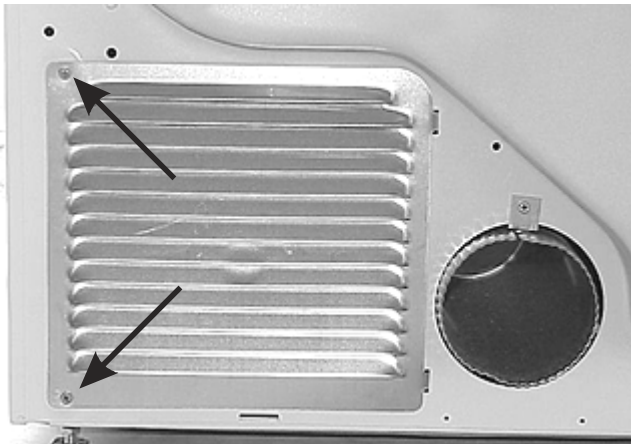

Removing the vane from the drum:

1. Disconnect the dryer from electrical supply.
2. Open the door, remove the top panel, remove the (2) screws holding the vane to the drum and drop the vane into the drum.

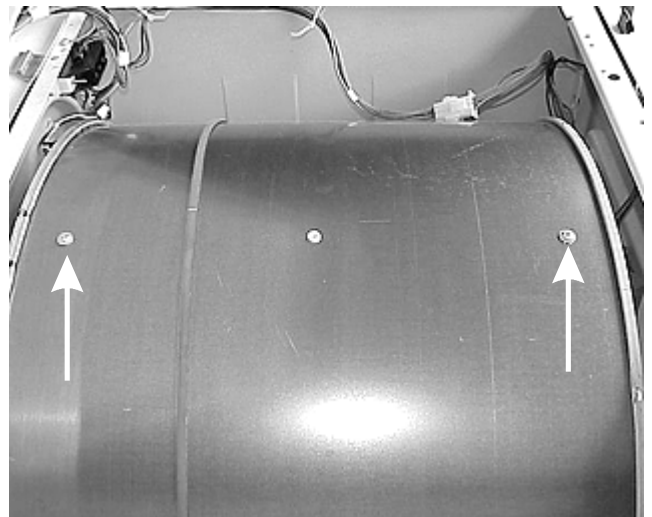

Releasing the dryer belt:

1. Remove the access panel.

Removing the drum:

1. Disconnect the dryer from electrical supply.
2. Remove the top and the front panels.
3. Release the belt from the motor.

- Using the belt to raise rear of the drum, release the ball from the hitch and move the drum out the front.



Removing the ball hitch from the drum:

- Disconnect the dryer from electrical supply and remove the drum.
- Remove the (3) screws from inside the drum holding the ball to the drum.

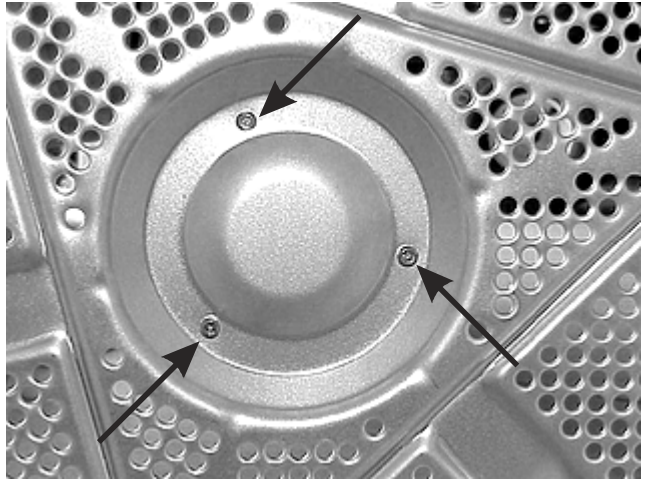

Removing the belt:

- Disconnect the dryer from electrical supply.
- Remove the top and the front panels.
- Release the belt from the motor.
- From the front, slightly raise the front of the drum and slide the belt off the drum.

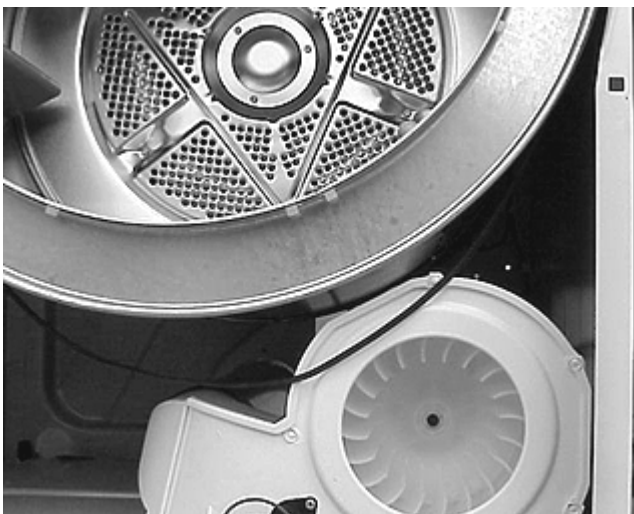

Removing the teflon glides:

- Disconnect the dryer from electrical supply and remove the front panel.
- Squeeze the tabs, holding the glides to the rim of the drum, to release the glides.

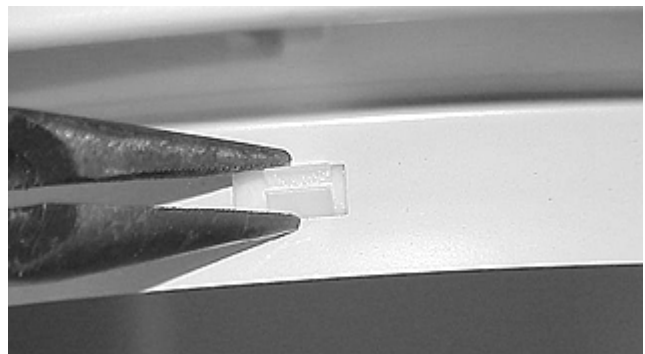

Removing the drum heat shield: (Electric dryers)

- Disconnect the dryer from electrical supply and remove the drum.

2. Remove the (3) screws holding the shield to the rear of the drum.

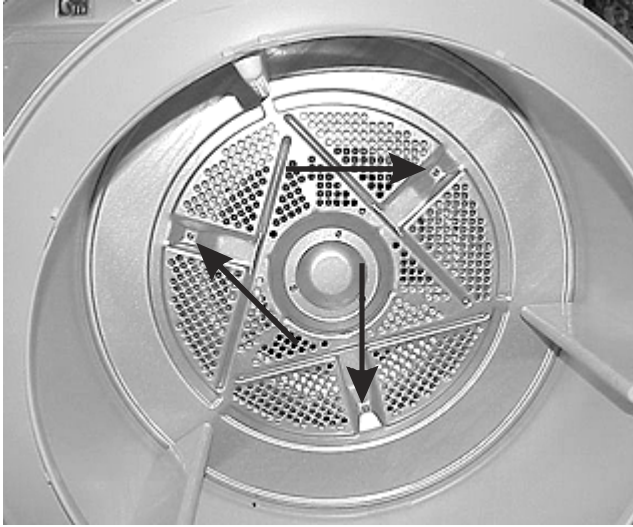

Removing the hitch:

1. Disconnect the dryer from electrical supply and remove the drum.
2. Using a 5/16" nut driver, remove the (2) screws holding the hitch to the rear panel while holding the large tinnerman clip from the rear of the dryer.



Note: Do not lose the grounding ball or the tinnerman mounting clip from the rear of the dryer.

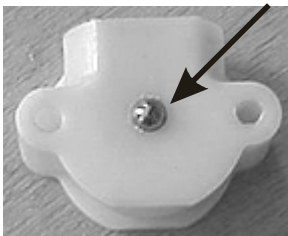

Removing the high limit thermostat:

1. Disconnect the dryer from electrical supply and remove the top panel.
2. Disconnect the (2) wires and remove the (2) screws holding thermostat to the heating element assembly.

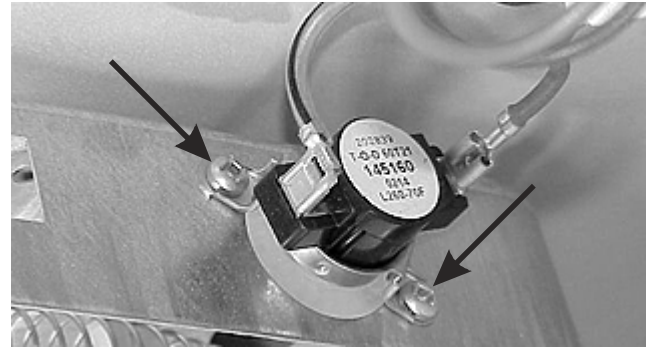

Removing the thermal limiter: (Electric dryers)

1. Disconnect the dryer from electrical supply and remove the top panel.
2. Disconnect the (2) wires and remove the (2) screws holding limiter to the rear panel.

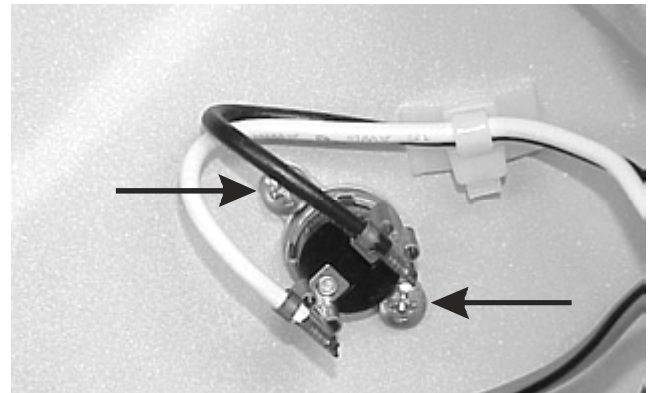

Removing the heating element assembly: (Electric dryers)

1. Disconnect the dryer from electrical supply and remove the drum.
2. Disconnect the (2) wires from the heating element.

3. Remove the high limit thermostat.

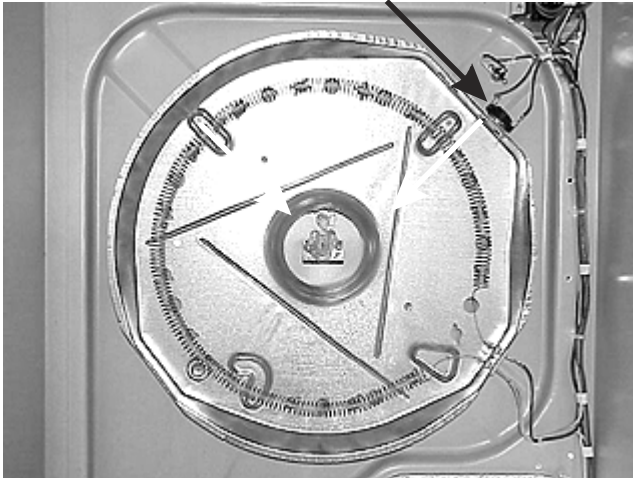

2. Disconnect the wires from the thermistor and remove the (2) screws holding the thermistor to the blower housing.

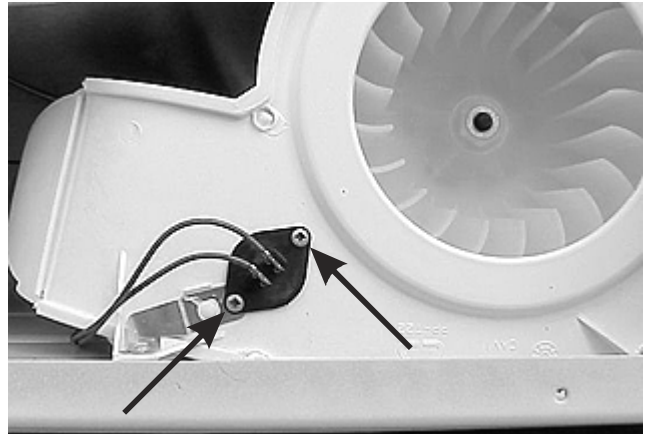

4. From the rear of the dryer, remove the (4) screws securing the heating element assembly to the rear of the cabinet.

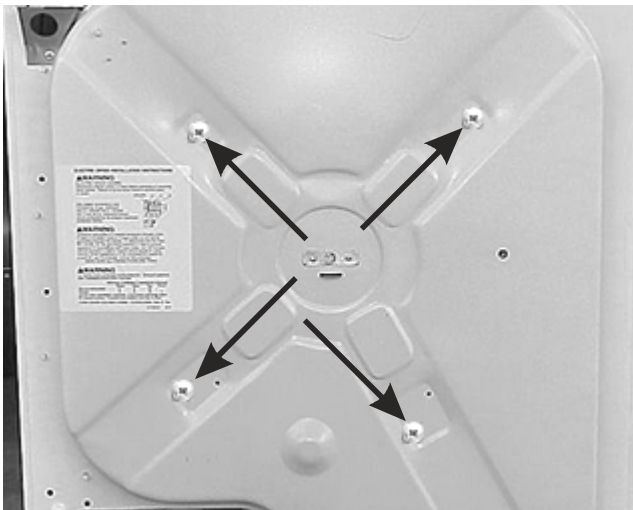

Removing the blower housing and fan blade:

1. Disconnect the dryer from electrical supply and remove the drum.
2. Remove the control thermistor.
3. Using a 7/8" socket, turn the fan blade clockwise while holding the motor shaft to remove the fan blade from the motor shaft.

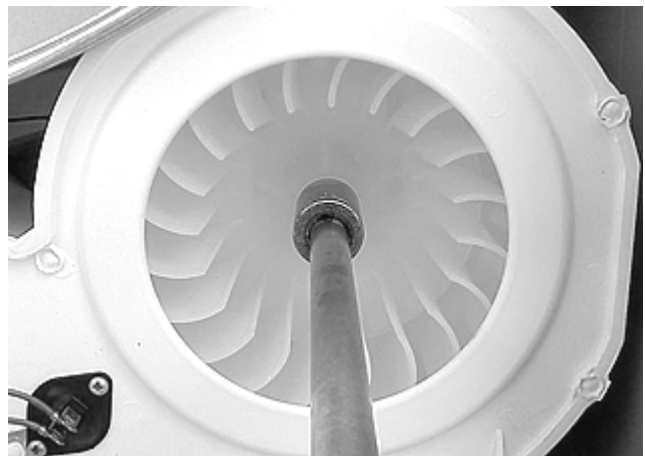

Removing the control thermistor:

1. Disconnect the dryer from electrical supply and remove the front panel.

- Remove (2) screws holding the housing to the dryer base.

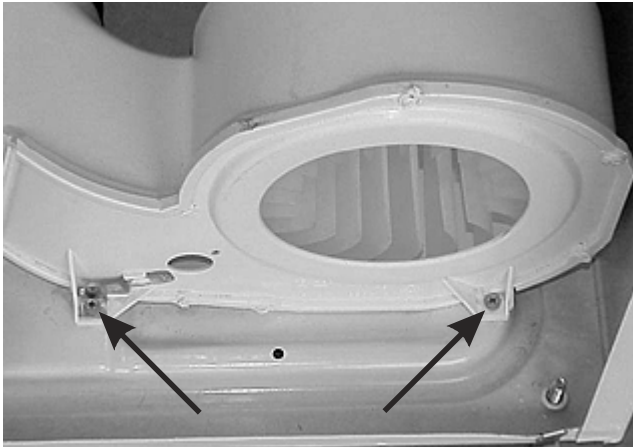

- Remove the front motor lock by inserting a screwdriver at the rear of the housing to release the housing from the motor.



- Raise the front of the motor and pull the housing forward.

Removing the idler pulley:

- Disconnect the dryer from electrical supply and remove the rear access panel.

- Release the belt from the motor pulley, remove the "C" clip from the shaft and slide the idler pulley off.



Removing the idler pulley assembly:

- Disconnect the dryer from electrical supply and remove the rear access panel.
- Release the belt from the motor pulley.
- Release the idler spring from the motor and lift the assembly off the motor.

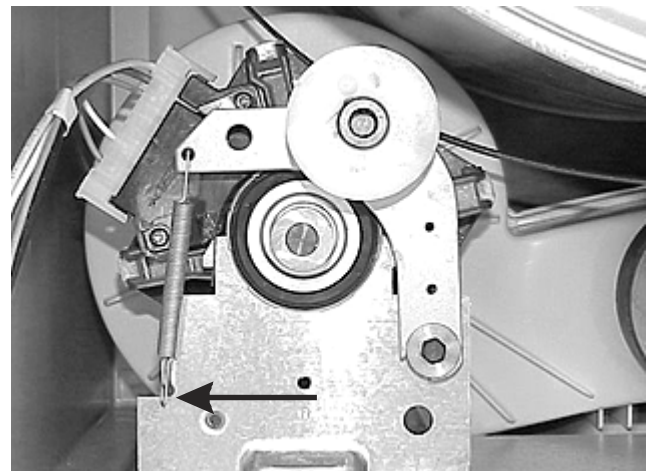

Removing the drive motor:

- Disconnect the dryer from electrical supply and remove the drum.
- Unplug the harness from the motor and remove the idler assembly.
- Unscrew the blower wheel from motor shaft.

4. Release the front motor lock from the blower housing.
5. Release the spring clip holding down on the rear of the motor and lift the motor out.

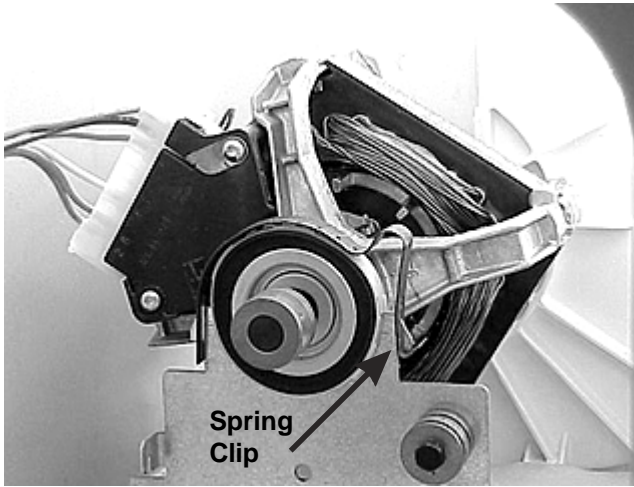

Removing the burner: (Gas dryers)

1. Disconnect the dryer from electrical supply and remove the front panel.
2. Unplug the igniter, remove the (2) screws holding the burner to the valve assembly bracket, and slide the burner into the combustion chamber to release burner from the valve.

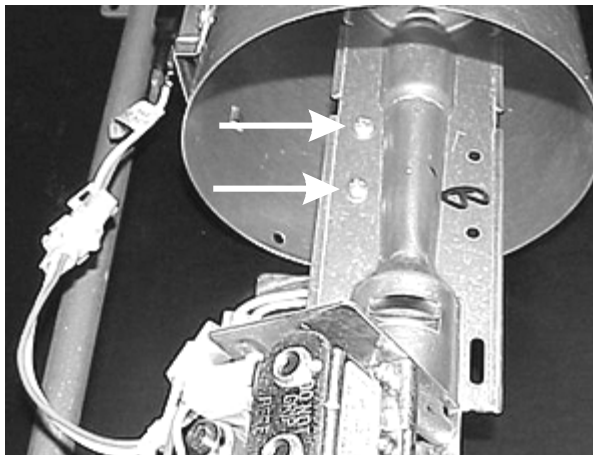

Removing the igniter: (Gas dryers)

1. Disconnect the dryer from electrical supply and unplug the igniter harness.

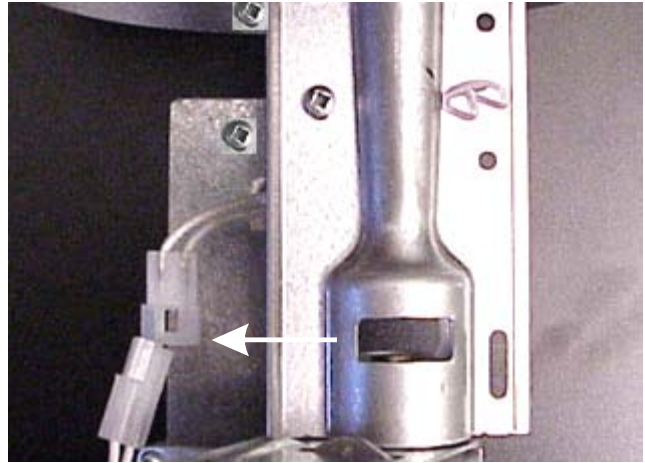

2. The igniter is held to the burner mounting bracket by a screw and a tab. Remove the screw and lift the igniter up to release the tab, then slide the igniter forward.

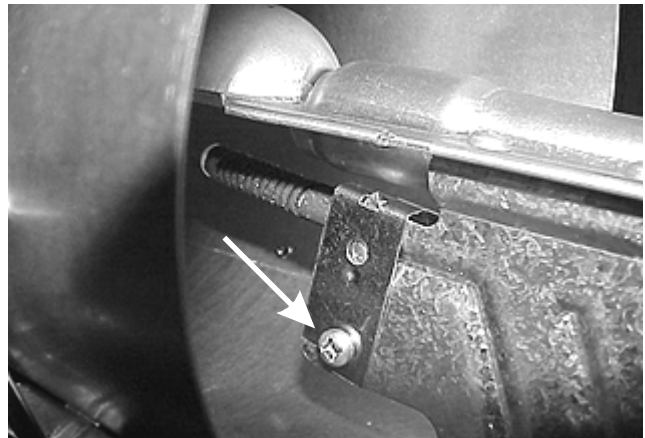

Removing the gas valve assembly: (Gas dryers)

1. Turn the gas supply off and disconnect the dryer from electrical supply.
2. Unplug the wires from the valves.

- Using a 15/16" open end wrench, disconnect the manifold pipe from the valve.

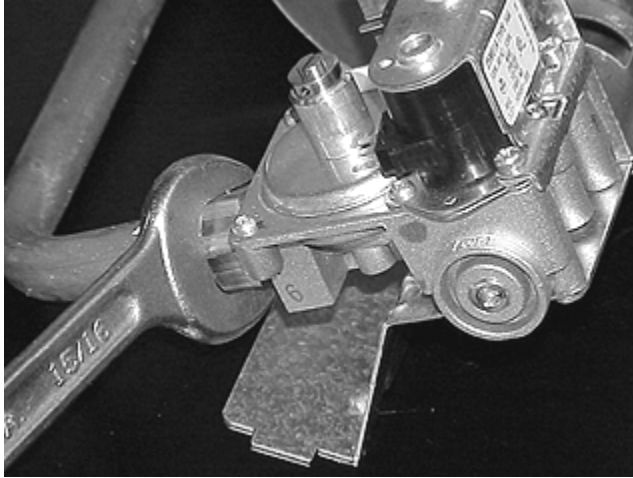

- Remove the (1) screw securing the gas valve assembly bracket to the base, slide the gas valve assembly forward and lift the gas valve assembly out.

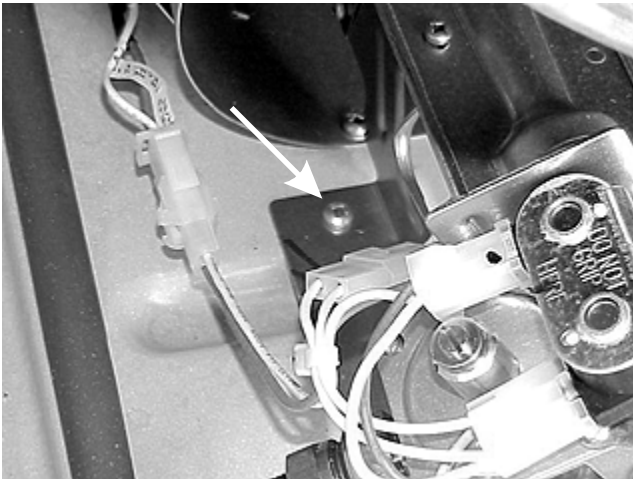

- Remove the (2) screws holding the valve to the bracket.

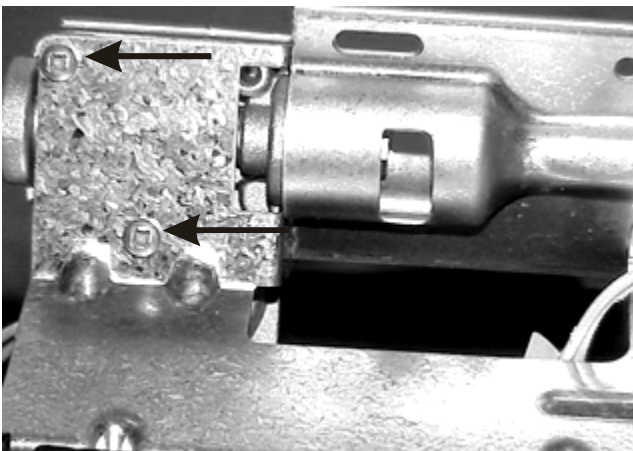

Removing the gas valve coils: (Gas dryers)

- Disconnect the dryer from electrical supply and remove the front panel.
- Disconnect the wires from the coils, remove the (2) screws holding the coil bracket to the valve base and lift the coils off.



Removing the sensor: (Gas dryers)

- Disconnect the dryer from electrical supply and remove the front panel.
- Disconnect the (2) wires from the sensor.
- Remove the (1) screw holding the sensor to the combustion chamber.

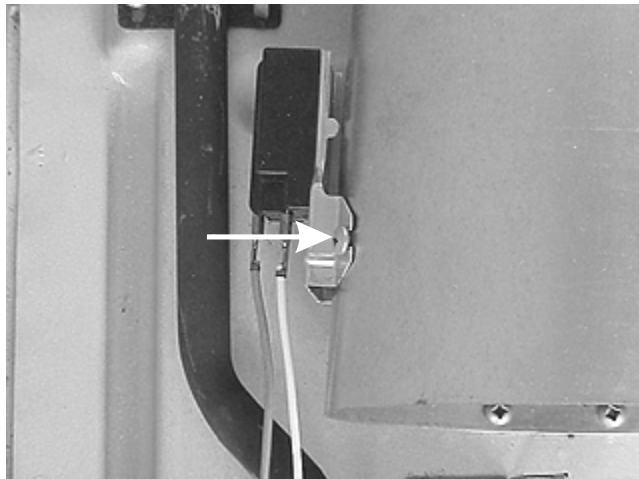

Removing the combustion chamber: (Gas dryers)

- Disconnect the dryer from electrical supply, remove the sensor and gas valve assembly.

- Remove the (2) screws holding the combustion chamber to the base, raise the end and pull the chamber out of the duct.

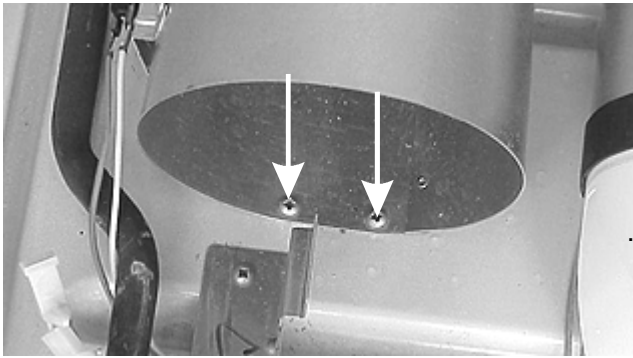

- Lift the shield and duct out of the dryer and remove the (3) screws holding duct to the heat shield.

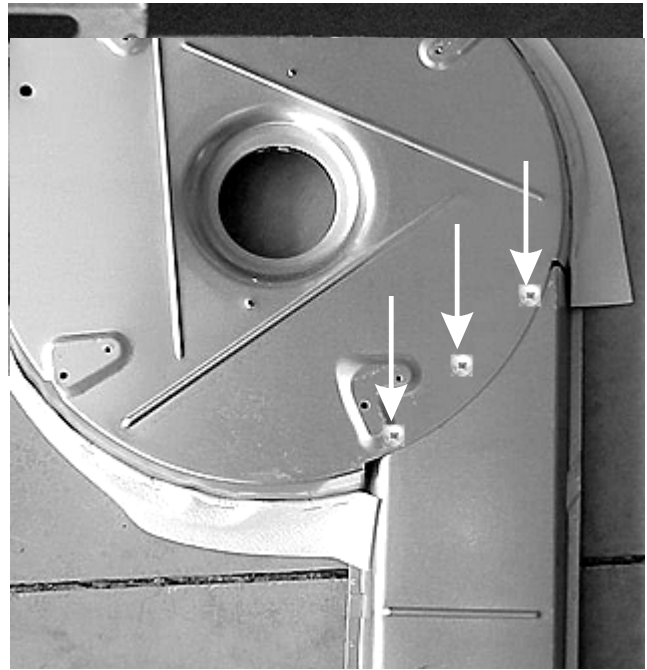

Removing the duct and heat shield: (Gas dryers)

- Disconnect the dryer from electrical supply, remove the drum.
- Remove (4) screws holding the heat shield to the rear panel.

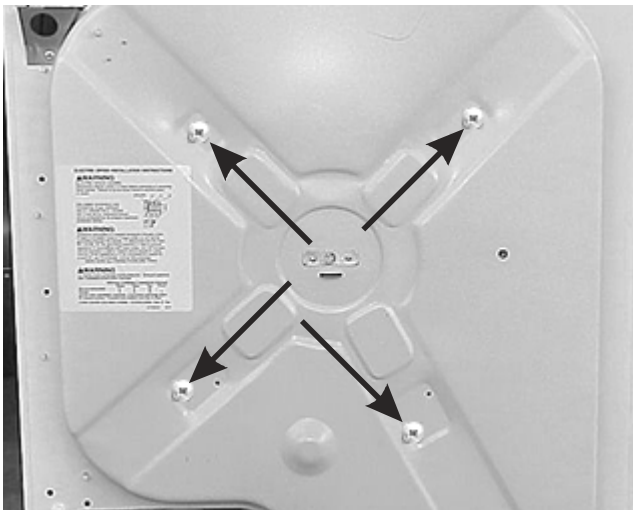

Removing the manifold pipe: (Gas dryers)

- Disconnect the dryer from electrical supply.
- Turn the gas supply off and disconnect the gas supply from the dryer.
- Remove dryer front panel.
- Using a 15/16" open end wrench disconnect manifold pipe from the valve.



5. Remove the (2) screws holding the manifold pipe to the base and lift the pipe out.



3. Remove the vent pipe out the rear of the dryer and remove the gasket from the vent pipe.

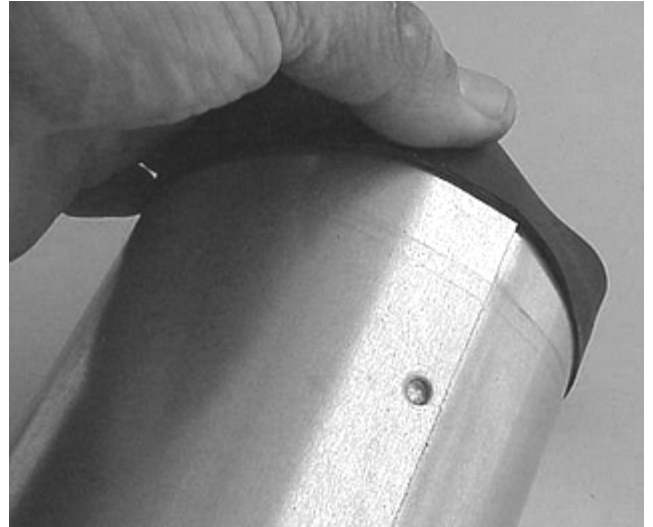

Removing the vent pipe: (Gas dryers)

1. Remove the (1) screw holding vent to the rear panel and pull the vent pipe out the back.

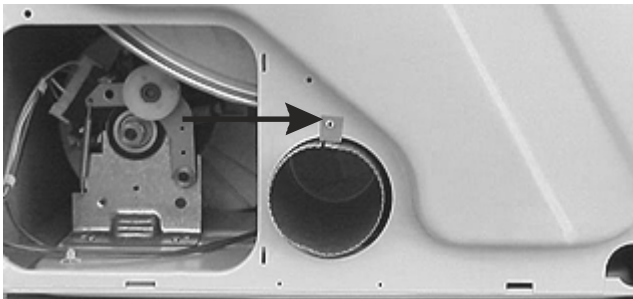

4. When reinstalling, install the gasket on the vent pipe, install the vent pipe in the dryer and slide half of the gasket on to the blower housing from the front of the dryer.

Removing the gasket between the vent pipe and blower housing : (Gas dryers)

1. Disconnect the dryer from electrical supply.
2. Remove front panel and slide the gasket completely on to the vent pipe.

