

INDEX

DISHWASHERS DW95

Asko Cylinda AB / After Sales

Box 344 • Axvällagatan 3 • SE-532 24 SKARA

Content

	Page
Dishwashers	
DW950, 951 952 95C	1-7
DW953, 354 955, 95FI	8-16

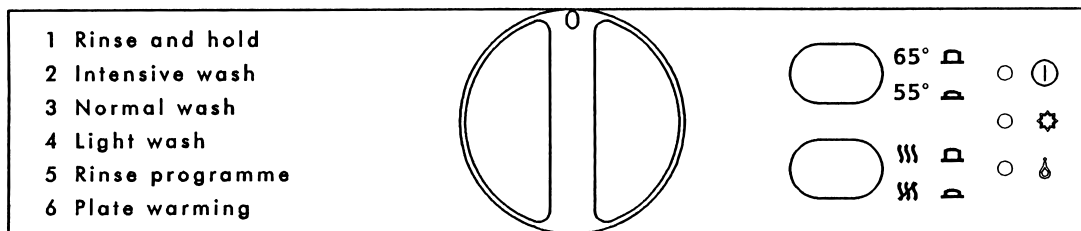

- 1 Rinse and hold
- 2 Intensive wash
- 3 Normal wash
- 4 Light wash
- 5 Rinse programme
- 6 Plate warming

1. PROGRAMS DW 950, 951, 952, 95C

Rinse & Hold program

One rinse without heat.

Intensive wash program

3 pre-washes, main wash, 2 rinses and drying.
Basic temperature: 65°C in first pre-wash, main wash and last rinse. 30°C in second pre-wash . 70°C in drying.

Normal wash program

Two pre-washes, main wash, 2 rinses and drying.
Basic temperature: 30°C in pre-wash, 55°C in main wash and last rinse. 70°C in drying.

Light wash program

One pre-wash, main wash, 2 rinses and drying.
Basic temperature: 55°C in main wash and last rinse. 70°C in drying.

Rinse program

One rinse and drying.
Basic temperature: 55°C in rinse. 70°C in drying.

Plate heating

One drying sequence.
Basic temperature: 65°C.

2. PROGRAM OPTIONS BUTTONS

The dishwasher can have 1, 2 or 3, option pushbuttons and 1 rotary switch for water softener setting.

Drying heat

You can select drying with or without heat.

Temperature

Selection between 55°C and 65°C in main wash, last rinse and in pre-wash in the Intensive wash program.

Program without heat (Pika pesu)

You can get a program without heat.

Setting of water softener (just softener machines)

The opening time for the softener inlet valve can be adjusted to suit different degrees of water hardness.

(3 settings which can be set with screw driver).

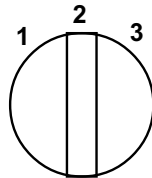

Pos 1	Water hardness < 20°dH .
Pos2	Water hardness 20—35 °dH
Pos3	Water hardness > 35 °dH

ELECTRICAL FUNCTION

CONTROL UNIT

DW951, 952, 95C has an electro-mechanical timer.

CIRCULATION PUMP

The circulation pump consists of an asynchronous motor and pump, constructed in an integrated unit. A 4 μ F capacitor is fitted to ensure reliable starting of the circulation pump.

OUTLET PUMP

The outlet pump consists of a synchronous motor and pump, constructed in an integrated unit.

INLET VALVE

Depending on model, there are three types of inlet valves:

1. With safety valve: Two solenoids independent from each other or valve seats are connected to a unit.
2. Single-unit type: A solenoid and valve seat.
3. Softener valve: Two valves in shunt, one for the regeneration of the softener and the other for normal inlet.

HEATING ELEMENT

Heating elements with the following capacities: 1800 W alt. , 2500 W

THERMOSTAT

Different thermostats are mounted, depending on model:

- 30/70°C Thermostat with two switch-off functions with the temperatures 30°C (reset at 22°C) and 70°C (reset at 62°C) for temperature stop in pre-wash or drying, respectively.
- 64/53°C Thermostat with two switch-off functions with the temperatures 64°C (reset at 56°C) and 53°C (reset at 45°C) for temperature stop in main wash and last rinse at high, or low temperature, alternately.
- 60°C Thermostat with one switch-off functions with the temperatures 60°C (reset at 52°C) for temperature stop in main-wash and last rinse on models without temperature selection.

HIGH TEMPERATURE CUTOUT

Thermostat with switch-off-function at 88°C, 190°F prevents the heating element from remaining continuously energised if the control unit or the timer should fail.

DOOR SWITCH

A microswitch senses that the door has been opened. This interrupts the program and cuts the power to all control components (motor, valves etc.). See fault indications on page 7.

LEVEL SWITCH

The level switch provides protection against overfilling, interrupting the power supply to the inlet valve and starting the outlet pump.

OVERFILL SWITCH

A float influences a micro switch which shuts the inlet valve and starts the outlet pump.

COMBI DISPENSER

The combi doser doses both detergent and rinse aid .

In the doser there is an adjustable volume chamber for setting of the desired amount of rinse aid. On certain models there is a sensor for rinse aid level mounted on the doser.

MAIN SWITCH

The main switch is a 2-pole switch, interrupting both the phase and neutral supplies.

ELECTRICAL CORD

The machines are fitted with 3x1,0mm² connection cords and earthed plugs. Variations occur for different markets.

ELECTRICAL SUPPLY

As delivered , the machines are wired for connection to a single-phase, 230 V, 10 A supply, with a heater MAIN SWITCH

The main switch is a 2-pole switch, interrupting both the phase and neutral supplies. power of 1800 W, giving a total power requirement of 2000 W.

Alternative:single-phase, 230 V, 16 A, heater power 3000 W total power requirement 3200 W . Alternative: 2-phase, 400 V, 10 A, heater power 3000 W total power requirement 3200 W.

SOFTNER

On certain models sensor for rinse aid level is mounted on the softner. This indicates by lack of salt.

FAN

Evacuates the moist air from the machine during the drying phase of the program.

The fan system consists of a fan motor which runs a two part impeller. Dry air is sucked in from the door into one of the impeller halves. A vax motor opens a valve, and the moist air streams into the other part of the impeller. Dry and moist air are mixed and led into a channel to the lower part of the door, where it is let out.

WATER SOFTENING

The water softener operates as follows:

During rinse, pre-wash and main wash:

1. Inlet valve 1 opens and admits water.
2. The water flows
 - through hose 3 to air-break device, no 1
 - passes an airgap
 - leaves the air-break device through no. 3
 - passes hose 7 to the resin container of the softener, no 3.

There the water is softened and the soft water flows

- out through no. 4
- through hose 8 back to the air-break device no. 4
- enters the machine through no. 6.

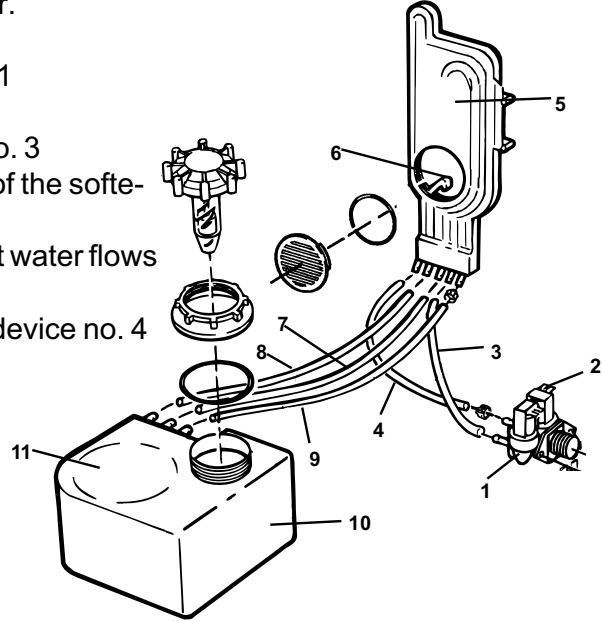

1. Inlet valve 1
2. Inlet valve 2 (regeneration valve)
3. Hose IV1 - air-break device
4. Hose IV2 - air-break device
5. Air-break device
6. Inlet opening
7. Hose air-break device no. 3- resin container no. 3
8. Hose air-break device no. 4 – resin container no. 4
9. Hose air-break device no. 5 - salt container no. 5
10. Salt container
11. Resin container

Resin container

Hard water, containing lime, $\text{Ca}(\text{HCO}_3)_2$ flows into the resin container. The Ca ions are replaced by Na. Soft water, containing $\text{Na}(\text{HCO}_3)$ flows into the machine.

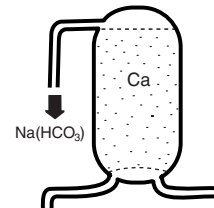
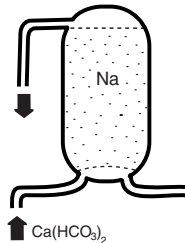

Regeneration during the main wash:

3. When the machine has admitted water, as described above, for the main wash, inlet valve 2 opens for 20,30 or 50 seconds, depending on the setting. The water flows through hose 4 to the air-break device 5, on through hose 9 and into salt container no. 5. The salt-saturated water flows into the resin container, where it regenerates the resin, so that it can soften further water.

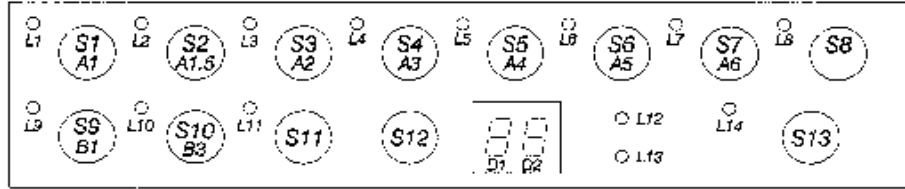
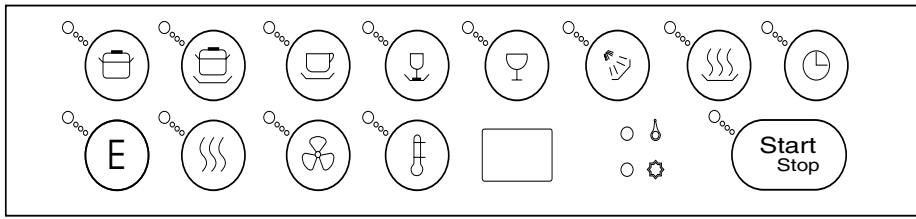

DW 955

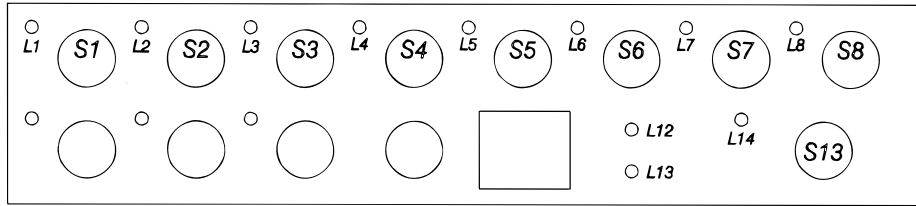

DW 954

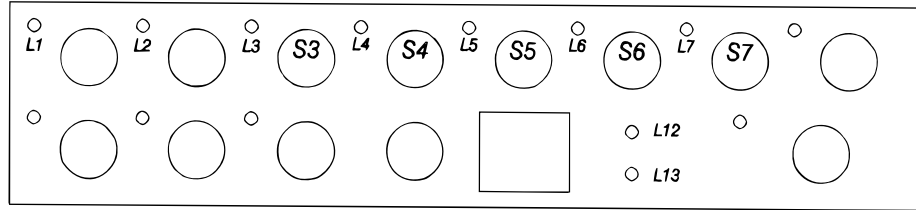

DW 953

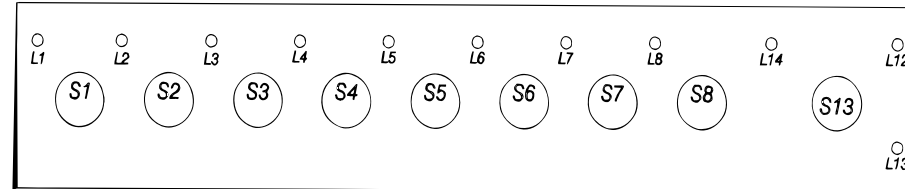

DW 95.FI

PROGRAMS DW 953, 954, 955, 95FI

Pots & Pans program

Two pre-washes, main wash, 4 rinses and drying.
Basic temperature: 45°C in first pre-wash 70°C in main wash, 65°C in last rinse.

Strong wash program

Two pre-washes, main wash, 3 rinses and drying.
Basic temperature: 45°C in first pre-wash, 65°C in main wash and last rinse.

Normal wash program

Two pre-washes, main wash, 2 rinses and drying.
Basic temperature: 30°C in pre-wash, 65°C in main wash and last rinse.

Light wash program

One pre-wash, main wash, 2 rinses and drying.
Basic temperature: 65°C in main wash and last rinse.

Quick wash program

One pre-wash, short main wash and 2 rinses.
Basic temperature: 55°C in main wash and last rinse.

Rinse & Hold program

One pre-wash without heat.

Plate heating

Consists of a dry sequence.

OPTIONS



Delayed start

DW 955: You can select 1-12h's delay.
DW 954/95.FI: Just 5h's delay.



EKO/BIO-function.

Lowers the temperature in pre wash and main wash to 50° C, 122°F and prolonges the washing time in main wash with 15 minutes.



Drying heat

The heating element can be selected "On" or "Off" during the drying period.



Fan drying

A cooling down period of 30 minutes is added before the program ends.



Temperature selection.

DW 955: In Intensive, Strong and Normal programs the temperatures 55, 65, 70 75°C, can be selected (70 and 75°C respectively just in last rinse).
Other programs: 45, 55 and 65°C.

DW 953/4/95.FI: Intensive wash; Temperature selection between 70 and 55°C.
Normal wash; between 65 and 55°C
Quick wash; between 55 and 45°C.



START/STOP

DW954/5: You start a program by a press on this button, and stop it by pressing the same button for 3 seconds.

DW953: The programs are started directly by pressing the program button and are stopped by pressing one of the program buttons for 3 second

EXTRA FAN COOLING (just DW954)

The fan cool the dishware for 30 minutes after drying

Press SI five times.

Press S5 to get an extra cooling

press S4 to get a normal cooling

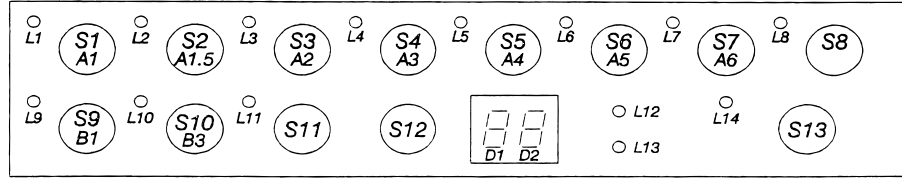

EXTRA RINSE (Not DW 953) ==

An extra rinse can be added in programs Intensive, Strong, Normal and Lightwash.

Press S2 five times

Press S5 to get an extra rise or
press S4 to get a normal number of rinses.

SETTING OF PUMPING-OUT TIME

The pumping-out time can be changed depending on bad pumping-out conditions.

Press S3 five times.

Press S3 to get an outlet time of	20 seconds or
press S4	" 25 seconds or
press S5	" 35 seconds or
press S6	" 45 seconds or
press S7	" 85 seconds

PROLONGED START FUNCTION

The start function can be re-programmed so that the button must be pressed in for 3 seconds to start the programs.

Press S4 five times.

Press S5 to get a prolonged start function or
press S4 to get a normal start function.

SETTING OF INLET TIME

There is a possibility to re-programme the inlet time on level controlled and time controlled inlets.

Press S5 five times.

Press S3 to get a normal inlet time or	
press S4 to get a prolonged time of	25% or
press S5	" 50% or
press S6	" 100% or
press S7	" 150% or
press S8	" 200% .

FAULT-TRACING PROGRAM

The functions of the electrical components can be tested:

Press S6 five times.

Press S2 for inlet valve 2.

Press S3 for inlet valve 1.

Press S4 for combi doser.

Press S5 for the heating element

Press S6 for the circulation pump.

Press S7 for the outlet pump.

Press S8 for fan motor and vax motor.

Stop the fault-tracing program by pressing S13 on DW 954 / 955, or one of the program buttons for 3 seconds on DW 953.

WATER HARDNESS SETTING (just machines with softener).

Press S7 five times within 15 seconds.

Press S2	for a water hardness of	0–9	°dH	
" S3	"	10–14	"	Normal setting
" S4	"	15–19	"	
" S5	"	20–24	"	
" S6	"	25–34	"	
" S7	"	35–49	"	
" S8	"	50–70	"	

COOL DOWN (Just DW955 without softener)

A Cool down period after the first pre-wash and main wash can be added on cold water connected machines (< 25°C, 77°F) and high wash temperatures (< =65°C, 149°F).

Press S9 five times.

Press S5 to get cool-down or

press S4 to get normal temperature.

LINKS ON THE PROCESSOR BOARD (for program variations)

Link 953: DW953 processor board layout

Link 955: DW955, processor board layout.

Link Europe: Europa processor board layout.

Link USA: USA processor board layout.

Link Soft: Machine with softener

Link SSP: Quick wash is replaced by "Pika Pesu" = a cold program, 15 minutes long.

Link 230V: Machine for 230V (hardware).

FAULT INDICATIONS

L3 and L7 and display "F1" (DW955) is blinking: Heating element fault.

L1-L8 and display "F2" (DW955) is blinking: Overfill.

L4 and L5 and display "F3" (DW955) is blinking: Sensor fault.

L6 and L7 and display "F4" (DW955) is blinking: Water inlet fault. (Just machines with level sensor).

L1-L4 together with L5-L8: The door is open during machine operation.

CONTROL UNIT

The control unit contains a microprocessor for control of programs, circulation pump, inlet valves etc.

CIRCULATION PUMP

The circulation pump consists of an asynchronous motor and pump, constructed in an integrated unit. A 4 μ F capacitor is fitted to ensure reliable starting of the circulation pump.

OUTLET PUMP

The outlet pump consists of a synchronous motor and pump, constructed in an integrated unit.

INLET VALVE

Depending on model, there are three types of inlet valves:

1. With safety valve: Two solenoids independent from each other or valve seats are connected to a unit.
2. Single-unit type: A solenoid and valve seat.
3. Softener valve: Two valves in shunt, one for the regeneration of the softener and the other for normal inlet.

HEATING ELEMENT

Heating elements with the following capacities: 1800 W, 2500 W and 1800 W + 1200 W alternatively.

THERMISTOR

The thermistor controls the water temperature to give the required temperature. The heater will be disconnected if the thermistor is short-circuited or loosened from the circuit board. See fault indications. The normal resistance of the thermistor is between 25 and 15 Kohm at 20°C, or 30°C alternately.

HIGH TEMPERATURE CUTOUT

Thermostat with switch-off-function at 88°C, 190°F prevents the heating element from remaining continuously energised if the control unit or the timer should fail.

DOOR SWITCH

A microswitch senses that the door has been opened. This interrupts the program and cuts the power to all control components (motor, valves etc.).

LEVEL SWITCH

The level switch provides protection against overfilling, interrupting the power to the inlet valve and starting the outlet pump.

If the water level has not dropped within 30 seconds or if overfill has occurred twice during the same program, the program will be terminated. The overfill protection operates during all programs, including fault-tracing, and even if the microprocessor is faulty.

OVERFILL SWITCH

A float influences a micro switch which disconnects the inlet valve and starts the outlet pump. Function: See "Level switch" above.

COMBI DISPENSER

The combi dispenser doses both detergent and rinse aid.

In the doser there is an adjustable volume chamber for setting of the desired amount of rinse aid.

On certain models there is a sensor for rinse aid level mounted on the doser.

MAIN SWITCH

The main switch is a 2-pole switch, interrupting both the phase and neutral supplies.

ELECTRICAL CORD

The machines are fitted with 3x1,0mm² connection cords and earthed plugs. Variations occur for different markets.

ELECTRICAL SUPPLY

As delivered, the machines are wired for connection to a single-phase, 230 V, 10 A supply, with a heater power of 1800 W, giving a total power requirement of 2000 W.

Alternative: single-phase, 230 V, 16 A, heater power 3000 W total power requirement 3200 W

Alternative: 2-phase, 400 V, 10 A, heater power 3000 W total power requirement 3200 W.

SOFTENER

If softener is used, link "Soft" must be taken away from the control unit. This means connecting of the softener valve. On certain models sensor for rinse aid level is mounted on the softener. This indicates by lack of salt.

FAN

Evacuates the moist air from the machine during the drying phase of the program.

The fan system consists of a fan motor which runs a two part impeller. Dry air is sucked in from the door into one of the impeller halves. A wax motor opens a valve, and the moist air streams into the other part of the impeller. Dry and moist air are mixed and led into a channel to the lower part of the door, where it is let out.

**ASKO
DISHWASHER
FAULT
TRACING**

1500

Fault tracing

Press the **Pots and Pans** button five times within fifteen seconds.

Press the **Pots and Pans** button once to test soap dispenser.

Press the **Normal Wash** button once to test rinse aid solenoid.

Press the **Delicate Wash** button once to test the vent solenoid.

Press the **P** button once to test the inlet valve.

Press the **Start** button once to advance to second level of test sequence.

Press the **Normal Wash** button once to test drain pump.

Press the **Delicate Wash** button once to test circulation pump.

Press the **P** button once to test the heating element.

Inlet time adjustment

Press the **Rinse and Hold** button five times within fifteen seconds.

Press the **Rinse and Hold** button once to adjust by minus five seconds.

Press the **Pots and Pans** button once to adjust by minus ten seconds.

Press the **Normal Wash** button once to adjust by minus fifteen seconds.

Press the **Dry** button once to adjust by minus twenty seconds.

Press the **Temperature** button once to reset back to normal.

Press the **Delicate Wash** button once to adjust by plus five seconds.

Press the **Light Wash** button once to adjust by plus ten seconds.

Press the **Plate Warm** button once to adjust by plus fifteen seconds.

Press the **E** button once to adjust by plus twenty seconds.

1502

Fault tracing

Press the **Heated Dry** button five times within fifteen seconds.

Press the **Rinse and Hold** button once to test the detergent solenoid.

Press the **Normal Wash** button once to test the rinse aid solenoid.

Press the **Delicate Wash** button once to test the vent solenoid.

Press the **Quick Wash** button once to test the inlet valve.

Press the **Heated Dry** button once to advance to part two of the test program.

Press the **Normal Wash** button once to test the drain pump.

Press the **Delicate Wash** button once to test the circulation pump.

Press the **Quick Wash** button once to test the heating element.

Inlet time adjustment

Press the **Pots and Pans** button five times within fifteen seconds.

To much water

Press the **Rinse and Hold** button once to decrease by five seconds.

Press the **Rinse and Hold** button twice to decrease by ten seconds.

Press the **Rinse and Hold** button three times to decrease by fifteen seconds.

To little water

Press the **Quick Wash** button once to increase by five seconds.

Press the **Quick Wash** button twice to increase by ten seconds.

Press the **Quick Wash** button three times to increase by fifteen seconds.

Press the **Normal Wash** button once to reset to normal fill time.

1473 and 1474

Fault tracing

Press the **Rinse and Hold** button five times within fifteen seconds.

Press the **Rinse and Hold** button once to test the detergent solenoid.

Press the **Pots and Pans** button once to test the rinse aid solenoid.

Press the **Normal Wash** button once to test the inlet valve.

Press the **Delicate Wash** button once to test the vent solenoid.

Press the **Quick Wash** button once to test the heating element.

Press the **Temperature** button once to test the circulation pump.

Press the **Heated Dry** button once to test the drain pump.

Inlet time adjustment

Press the **Pots and Pans** button five times within fifteen seconds.

Press the **Heated Dry** button one time to increase by ten seconds.

Press the **Heated Dry** button twice to increase by twenty seconds.

Press the **Heated Dry** button three times to increase by forty seconds.

Press the **Heated Dry** button four times to increase by sixty seconds.

Press the **Heated Dry** button five times to increase by one hundred twenty seconds.

Press the **Temperature** button once to reset back to normal inlet time.

1503 and 1504

Fault tracing

Press the **Heated Dry** button five times within fifteen seconds.

Press the **Rinse and Hold** button once to test detergent solenoid.

Press the **Pots and Pans** button once to test the rinse aid solenoid.

Press the **Normal Wash** button once to test the inlet valve.

Press the **Delicate Wash** button once to test softener inlet valve. (not on all machines)

Press the **Quick Wash** button once to test the drain pump.

Press the **Extra Rinse** button once to test the circulation pump.

Press the **Plate Warm** button once to test the heating element.

Press the **Heated Dry** button once to test the vent solenoid.

Inlet time adjustment

Press the **Pots and Pans** button five times within fifteen seconds.

Press the **Extra Rinse** button once to increase by ten seconds.

Press the **Extra Rinse** button twice to increase by twenty seconds.

Press the **Extra Rinse** button three times to increase by forty seconds.

Press the **Extra Rinse** button four times to increase by sixty seconds.

Press the **Extra Rinse** button five times to increase by eighty seconds.

Press the **Extra Rinse** button six times to increase by one hundred seconds.

Press the **Extra Rinse** button seven times to increase by one hundred twenty seconds.

Press the **Quick Wash** button once to reset to normal inlet time.

1475/1485/1776/1796FI

Fault tracing

Press the **Rinse and Hold** button five times within fifteen seconds.

Press the **Pots and Pans** button once to test inlet valve.

Press the **Normal Wash** button once to test detergent dispenser.

Press the **Normal Wash** button again to test rinse aid dispenser.

Press the **Quick Wash** button once to test heating element.

Press the **Rinse and Hold** button once to test circulation pump.

Press the **Heated Dry** button once to test drain pump and fan motor.

Inlet time adjustment

Press the **Quick Wash** button five times within fifteen seconds.

Press the **Pots and Pans** button to reset to normal fill time.

Press the **Normal Wash** button once to increase by fifteen seconds.

Press the **Quick Wash** button once to increase by thirty seconds.

Press the **Rinse and Hold** button once to increase by sixty seconds.

Press the **Heated Dry** button once to increase by one hundred twenty seconds.

Drain time adjustment

Press **Pots and Pans** button five times within fifteen seconds.

Press the **Pots and Pans** button once to decrease drain time by five seconds.

Press the **Normal Wash** button once to reset to normal drain time.

Press the **Quick Wash** button once to increase by ten seconds.

Press the **Rinse and Hold** button once to increase by twenty seconds.

Press the **Heated Dry** button once to increase by sixty seconds.

Protected start

Press the **Normal Wash** button five times within fifteen seconds.

Press the **Quick Wash** button once to a three second protected start.

Press the **Normal Wash** button once for a normal start.

1555

Fault tracing

Press the **Temperature Boost** button five times within fifteen seconds.

Press the **Super Wash** button once to test the water softener inlet valve. (not on all machines)

Press the **Normal Wash** button once to test the inlet valve.

Press the **Quick Wash** button once to test the detergent dispenser.

Press the **Quick Wash** button again to test the rinse aid dispenser.

Press the **Rinse and Hold** button once to test the heating element.

Press the **Temperature Boost** once to test the circulation pump.

Press the **Heated Dry** button once to test the drain pump.

Press the **Delayed Start** (clock) button once to test the fan motor.

Inlet time adjustment

Press the **Rinse and Hold** button five times within fifteen seconds.

Press the **Normal Wash** button once to reset to normal fill.

Press the **Quick Wash** button once to increase by fifteen seconds.

Press the **Rinse and Hold** button once to increase by thirty seconds.

Press the **Temperature Boost** once to increase by sixty seconds.

Press the **Heated Dry** button once to increase by ninety seconds.

Press the **Delayed Start** (clock) button once to increase by one hundred twenty seconds.

Drain time adjustment

Press the **Normal Wash** button five times within fifteen seconds.

Press the **Normal Wash** button once to decrease by five seconds.

Press the **Quick Wash** button once to reset to normal drain time.

Press the **Rinse and Hold** button once to increase by ten seconds.

Press the **Temperature Boost** once to increase by twenty seconds.

Press the **Heated Dry** button once to increase by sixty seconds.

Protected start

Press the **Quick Wash** button five times within fifteen seconds.

Press the **Rinse and Hold** button once to get protected start. (3 sec)

Press the **Quick Wash** button once for normal start.

1585

Fault tracing

Press the **Temperature** button five times within fifteen seconds.

Press the **Pots and Pans** button once to test the softener inlet valve. (not on all machines)

Press the **Normal Wash** button once to test the inlet valve.

Press the **Quick Wash** button once to test the detergent solenoid.

Press the **Quick Wash** button again to test the rinse aid solenoid.

Press the **Rinse and Hold** button to test the heater.

Press the **Temperature** button once to test the circulation pump.

Press the **Heated Dry** button once to test outlet pump and fan motor.

Inlet time adjustment

Press the **Rinse and Hold** button five times within fifteen seconds.

Press the **Normal Wash** button once to reset to normal fill time.

Press the **Quick Wash** button once to increase by fifteen seconds.

Press the **Rinse and Hold** button once to increase by thirty seconds.

Press the **Temperature** button once to increase by sixty seconds.

Press the **Heated Dry** button once to increase by ninety seconds.

Drain time adjustment

Press the **Normal Wash** button five times within fifteen seconds.

Press the **Normal Wash** button once to decrease by five seconds.

Press the **Quick Wash** button once to reset to normal drain time.

Press the **Rinse and Hold** button once to increase by ten seconds.

Press the **Temperature** button once to increase by twenty seconds.

Press the **Heated Dry** button once to increase by sixty seconds.

Protected start

Press the **Quick Wash** button five times within fifteen seconds.

Press the **Rinse and Hold** button once for protected start. (3 seconds)

Press the **Quick Wash** button once for normal start.

1595/1876

Fault tracing

Press the **Temperature** button five times within fifteen seconds.

Press the **Quick Wash** button once to test inlet valve.

Press the **Rinse and Hold** button once to test soap dispenser solenoid.

Press the **Rinse and Hold** button again to test rinse aid dispenser.

Press the **E** button once to test heating element.

Press the **Temperature** button once to test circulation pump.

Press the **Heated Dry** button once to test drain pump.

Press the **Delayed Start** (clock) button to test fan motor.

Inlet time adjustment

Press the **E** button five times within fifteen seconds.

Press the **Quick Wash** button once to reset to normal fill time.

Press the **Rinse and Hold** button once to increase by fifteen seconds.

Press the **E** button once to increase by thirty seconds.

Press the **Temperature** button once to increase by sixty seconds.

Press the **Heated Dry** button once to increase by ninety seconds.

Press the **Delayed Start** (clock) button once to increase by one hundred and twenty seconds.

Drain time adjustment

Press the **Quick Wash** button five times within fifteen seconds.

Press the **Quick Wash** button once to decrease by five seconds.

Press the **Rinse and Hold** button once to reset to normal fill time.

Press the **E** button once to increase by ten seconds.

Press the **Temperature** button once to increase by twenty seconds.

Press the **Heated Dry** button once to increase by sixty seconds.

Protected start program

Press the **Rinse and Hold** button five times within fifteen seconds.

Press the **E** button once for protected start. (3 seconds)

Press the **Normal Wash** button once for normal start.

1805/1996

Fault tracing-for the FI unit, open the door, press the desired buttons and close the door and the corresponding component should come on.

Press the **Temperature** button five times within five seconds.

Press the **Normal Wash** button once and close door to test softener inlet valve. (not on all machines)

Press the **Quick Wash** button once and close door to test inlet valve.

Press the **Rinse and Hold** button once and close the door to test detergent solenoid.

Press the **Rinse and Hold** button again and close door to test rinse aid solenoid.

Press the **E** button once and close door to test heater.

Press the **Temperature** button once and close door to test circulation pump.

Press the **Heated Dry** button once and close door to test drain pump.

Press the **Delayed Start** (clock) button and close door to test the fan.

Inlet time adjustment

Press the **E** button five times within fifteen seconds.

Press the **Quick Wash** button once to reset to normal fill time.

Press the **Rinse and Hold** button once to increase by fifteen seconds.

Press the **E** button once to increase by thirty seconds.

Press the **Temperature** button once to increase by sixty seconds.

Press the **Heated Dry** button once to increase by ninety seconds.

Press the **Delayed Start** (clock) button once to increase by one hundred twenty seconds.

Drain time adjustment

Press the **Quick Wash** button five times within fifteen seconds.

Press the **Quick Wash** button once to decrease by five seconds.

Press the **Rinse and Hold** button once to reset to normal drain time.

Press the **E** button once to increase by ten seconds.

Press the **Temperature** button once to increase by twenty seconds.

Press the **Heated Dry** button once to increase by sixty seconds.

Protected start

Press the **Rinse and Hold** button once within fifteen seconds.

Press the **E** button once for protected start. (3 seconds)

Press the **Rinse and Hold** button once for normal start.

1885/1895/1976/1976CUS

Fault tracing

Press the **Rinse and Hold** button five times within fifteen seconds.

Press the **Super Wash** button once to test softener inlet valve. (not on all machines)

Press the **Normal Wash** button once to test inlet valve.

Press the **Light Wash** button once to test detergent solenoid.

Press the **Light Wash** button again to test rinse aid solenoid.

Press the **Quick Wash** button once to test heater.

Press the **Rinse and Hold** button once to test circulation pump.

Press the **Plate Warm** button once to test drain pump.

Press the **Delayed Start (clock)** button once to test fan.

Inlet time adjustment

Press the **Quick Wash** button five times within fifteen seconds.

Press the **Normal Wash** button once to reset to normal fill time.

Press the **Light Wash** button once to increase by fifteen seconds.

Press the **Quick Wash** button once to increase by thirty seconds.

Press the **Rinse and Hold** button once to increase by sixty seconds.

Press the **Plate Warm** button once to increase by ninety seconds.

Press the **Delayed Start (clock)** button once to increase by one hundred twenty seconds.

Drain time adjustment

Press the **Normal Wash** button five times within fifteen seconds.

Press the **Normal Wash** button once to decrease by five seconds.

Press the **Light Wash** button once to reset to normal drain time.

Press the **Quick Wash** button once to increase by ten seconds.

Press the **Rinse and Hold** button once to increase by twenty seconds.

Press the **Plate Warm** button once to increase by sixty seconds.

Protected start

Press the **Light Wash** button five times within fifteen seconds.

Press the **Quick Wash** button once for protected start (3 seconds).

Press the **Light Wash** button once for normal start.