

MAYTAG

Maytag

**Dishwasher
Service Manual**

16000374
Issued 3/93
Revised 3/98



Contents

SECTION 1. ELECTRICAL EQUIPMENT & TESTING	1-1
APPLIANCE TEST METER	1-1
CLAMP-ON AMMETER	1-3
MOTOR TEST CORD	1-4
WATER VALVE TEST	1-4
WAX MOTORS - DETERGENT AND RINSE AID DISPENSERS	1-5
DRIVE MOTOR TEST	1-5
VOLTAGE CHECKS	1-7
WATTAGES	1-7
GROUNDING & POLARITY	1-7
SECTION 2. ELECTRICAL-MECHANICAL TROUBLESHOOTING	2-1
TRUBLESHOOTING - ALL MODELS	2-1
DISHWASHER WON'T FILL	2-1
DISHWASHER OVERFLOWS	2-1
SLOW FILL	2-2
WILL NOT WASH	2-2
DISHWASHER WILL NOT DRAIN	2-3
DISHES WILL NOT DRY	2-4
DISHWASHER LEAKS	2-5
DISHWASHER NOISY	2-5
WATER PIPES VIBRATING (WATER HAMMER)	2-5
TRUBLESHOOTING - MICROPROCESSOR MODELS	2-6
WILL NOT PROGRAM (MODELS WITH DISPLAY WINDOW)	2-6
WILL NOT FILL	2-6
WILL NOT WASH	2-7
DETERGENT CUP WILL NOT TRIP	2-7
RINSE DISPENSER WON'T WORK	2-7
DISHWASHER WILL NOT DRAIN	2-8
DISHWASHER WILL NOT DRY	2-8
ELECTRICAL TEST - MICROPROCESSOR MODELS	2-9
DWU9920	2-11
DWU9905/DWU8890	2-14
ELECTRICAL TROUBLESHOOTING - MICROPROCESSOR MODELS	2-16
TRANSFORMER	2-16
MICROPROCESSOR BOARD	2-19
CONTROL RELAYS	2-20
RELAY BOARD	2-21
THERMOSTAT (BOOST)	2-22
LIMITING THERMOSTAT	2-22
DETERGENT & RINSE AID DISPENSERS	2-23
SECTION 3. SERVICE PROCEDURES	3-1

OUTER DOOR PANEL	3-1
ACCESS AND TOE PANELS	3-1
INNER DOOR PANEL	3-1
DOOR SWITCH HOUSING AND BRACKET ASSEMBLY	3-2
DOOR GASKET	3-4
CONTROL PANEL (CONSOLE)	3-4
TRANSFORMER - MICROPROCESSOR MODELS	3-6
VARISTOR - MICROPROCESSOR MODELS	3-7
CONTROL SWITCH	3-8
TIMER	3-9
DOOR HINGES - SPRINGS	3-10
HINGE SPRINGS	3-11
DOOR SPRING ADJUSTMENT	3-12
UPPER WASH ARM	3-13
UPPER WASH ARM HOSE	3-13
POWER MODULE	3-16
JUNCTION BOX COVER	3-24
THERMOSTATS	3-25
WATER VALVE	3-26
BLOWER ASSEMBLY	3-30
START RELAY	3-31
FLOAT ASSEMBLY	3-31
VENT COVER	3-35
HEATING ELEMENT	3-36
WATTAGE READING	3-38
WOOD TOP	3-39
CABINET	3-39
CASTERS	3-41
RETAINER FOR FAUCET COUPLER	3-42
FAUCET COUPLER	3-43
SECTION 4. GENERAL INFORMATION	4-1
SPECIFICATIONS	4-1
WARRANTY	4-3
MODELS AND FEATURES	4-4
CYCLES	4-5
SCHEMATICS	4-6

INTRODUCTION

Model numbers covered in this manual:

Built-in Models:

DWU9920 DWU9905 DWU9200 DWU8890 DWU8860 DWU8750 DWU8530
DWU8460 DWU8450 DWU8330 DWU8270 DWU8260 DWU8250 DWU8240
DWU7910 DWU7600 DWU7550 DWU7500 DWU7450 DWU7400 DWU7300
DWU5910 DWU4910

Convertible/Portable Model:

DWC8330 DWC8240 DWC7400 DWC4910

This service manual is intended to assist you in diagnosing conditions which may develop in the MAYTAG Jetclean™ dishwasher. Electrical component testing is for the most part, made with an appliance test meter and consists of checking for open or closed circuits. Mechanical checks are made through sight and sound, along with the use of a clamp-on ammeter.

This manual is designed for the technician who is familiar with the operation and construction of Maytag products. Information contained in this manual is intended for use by a qualified service technician, familiar with proper and safe procedures to be followed when repairing an electrical appliance. All tests and repairs should be performed by a qualified service technician equipped with proper tools and measuring devices. All component replacements should be made by a qualified service technician, using only MAYCOR replacement parts.

Improper assembly or adjustment may occur if service or repair is attempted by persons other than qualified service technicians or if parts other than MAYCOR replacement parts are used. Improper assembly or adjustment can cause hazardous conditions.

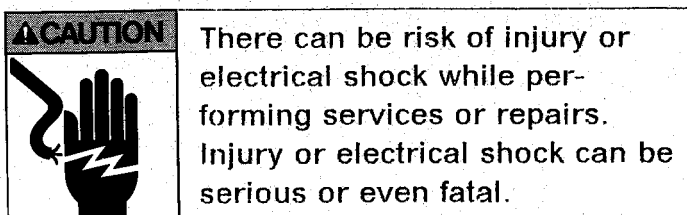

The first and most important step of any service call is to accurately determine what the complaint is. This is best accomplished by questioning the customer, finding out what the product is or isn't doing and why they feel a problem exists.

SECTION 1 covers **Electrical Test Equipment** for use on the dishwasher. This section also covers general use of the equipment, in addition to providing specific information on amperage, wattage and resistance readings which should be seen.

SECTION 2 covers **Electrical-Mechanical Troubleshooting** and provides a list of possible complaints. Find the complaint which you feel best matches that provided by the customer and turn to the appropriate page(s). You will find a list of possible electrical and mechanical problems for the complaint, which have been listed in order of:

1. Ease in checking.
2. Probability.

Systematically eliminating these possibilities will allow you to find and correct the problem.

SECTION 3 covers **Service Procedures**. This section will provide information on location of components, disassembly and/or reassembly procedures, the purpose and/or function of the part and in some instances specific checks to be made.

SECTION 4 covers **General Information** such as brief specifications, cycle descriptions and schematics.

SECTION 1. ELECTRICAL EQUIPMENT & TESTING

The equipment required to service Maytag products depends largely upon the condition encountered. Locating a malfunction will often require the use of electrical testing equipment such as:

Appliance Test Meter

Clamp-on Ammeter

Motor Test Cord

APPLIANCE TEST METER

An Appliance Test Meter is a multi-purpose tester combining an AC-DC voltage tester with a multi-range ohmmeter.



Probably the easiest means of testing electrical components is "continuity testing" with an appliance test meter. Continuity is a complete or continuous path from one point in an electrical circuit to another point.

The obvious advantages of being able to check electrical components and circuits without power applied is one of the features of the ohmmeter. Multiple ranges allow accurate determination of resistances of both single components and entire circuit paths. Resistance is measured in "ohms".

SET METER FOR USE AS FOLLOWS:

1. Calibrate meter by touching test probes together and turning adjusting dial until meter reads "0" on the ohm scale. Recheck calibration whenever adjusting dial for ohms settings is changed. (Replace battery if adjustment will not bring meter reading to "0".)
2. Select the scale most easily read and place test probes on respective terminals. When checking a switch, the reading would normally be either open or closed. A reading of 70 on the R x 10 scale would for example be 700 ohms resistance.

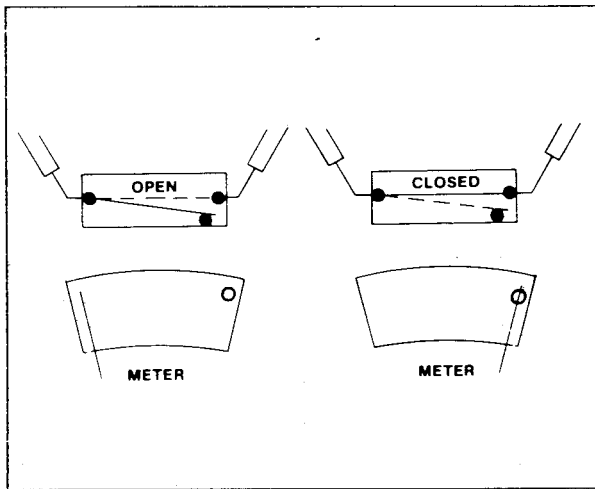

Note: *Always be sure the power has been disconnected before making resistance measurements. Failure to do so will result in damage to your meter! Internal batteries provide all the power needed to make resistance checks. They should be checked at least once a year and replaced as needed.*

For the most part, we will only be concerned with continuity. Is there a path or not? References are made between a "closed" (continuity) reading and an "open" (no continuity) reading. One note, when you get an "open" reading, try a higher resistance range (setting). A very high resistance appears as an "open" on the lower ranges. For best accuracy always "re-zero" meter when changing ranges and/or the physical position of the meter.

Continuity testing, as related to an electrical component, is the check of a part for an "open" or "closed" circuit.

Electrical components fall into two general categories.

1. **Loads** - Devices that **use** or consume electricity. Examples would include drive motor, heating elements, lamps, timer and solenoid coils.
2. **Switches** - Devices that **control** the supply of electricity to the load or loads in a circuit. Examples include door switches, timer contacts, selector switch and relay contacts.

Continuity tests of "load" devices will show varying levels of resistance from very low for some transformer and motor windings to very high for some timer motors and components on electronic control boards. Usually it is more important to know if there is a path for current flow through a device (continuity) than to know the exact resistance (ohms) of the device.

Continuity tests of switches will show virtually no resistance across closed contacts. Resistance, even low values indicates burned or dirty contacts in a switch.

Continuity testing is a process of eliminating those electrical components involved in a given function of the appliance, until the inoperative part is found. By reviewing the list of possible electrical problems under a given condition, and then performing appropriate continuity checks of the parts involved, you should be able to locate the electrical component which is inoperative.

When checking components or circuit paths for continuity, external wiring should be disconnected to eliminate false readings through external paths. Isolate what you want to test.

COMPONENT	OHMS
Heating Element	22
Timer Motor	2700-3000
Advance Relay Coil	350
120 Volt AC Water Valve Solenoid Coil	900
24 Volt DC Water Valve Solenoid Coil	140-160
Wax Motors - Detergent and Rinse Aid Dispensers	1900

These values are provided so that you may have an idea of the resistance that you can see in testing. These resistances are not meant to be used as the exact values to determine whether a component should be replaced. They are provided so that you may have an idea of the resistance that you can see in testing components.

cation of the performance of that circuit. Current draw levels, less than or more than normal, give clues to malfunctions. The clamp-on ammeter measures these currents without breaking the circuit by measuring the strength of the magnetic field developed around each conductor. Current is read by separating the conductors and clamping the jaws of the ammeter around each conductor on which current is to be read. Low amperage readings indicate problems such as damaged heating elements, etc. High amperage readings indicate the unit being tested is operating under an increased mechanical or electrical load.

Note: Overloads on a circuit breaker or fuse can be traced to the product being tested or the circuit breaker (or fuse) by checking the product's current draw. If the amperage reading is less than the breaker reading, the breaker or fuse box is at fault.

CLAMP-ON AMMETER

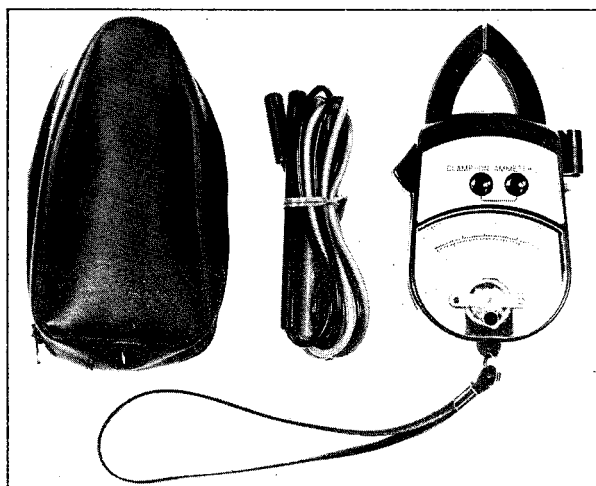

Each circuit in an appliance has a "normal" current draw which is an indi-

USE OF AMMETER ON DISHWASHER

- Motor Current** - The reading can be taken at the leads on the motor start relay or at the molex connector.
- Heating Element Current** - The reading can be taken using either lead to the element.

AMPERAGE CHART

CYCLE	AMPS
Wash	5 1/2
Drain (Start)	6 1/2
Circulate Heat	11
Heat Only	5 - 5.4
Heater and Blower	5 1/2

MOTOR TEST CORD

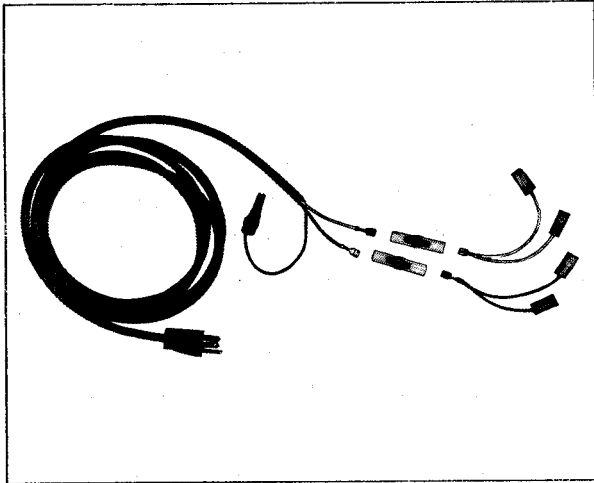

A motor test cord may be used to electrically check operation of the various electrical components without removing them from the unit. Testing in this manner merely determines whether or not the part will function independently of other electrical components. In order to make accurate tests, proper connection of the motor test cord is important. With the aid of the drawings under Drive Motor Test, installation of the motor test cord may be done quickly and accurately.

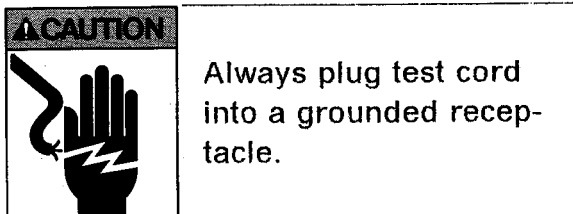

WATER VALVE TEST

The water valve may be checked without removing it from the dishwasher.

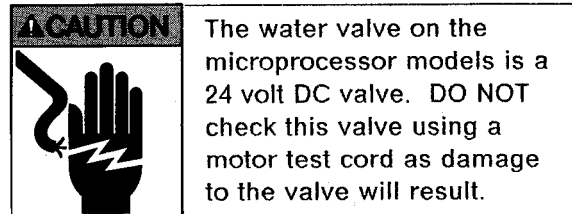

To check the water valve for operation hook up the test cord as follows.

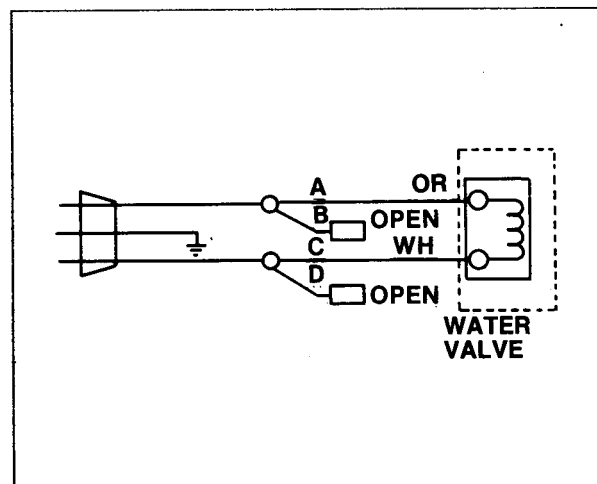

WAX MOTORS - DETERGENT AND RINSE AID DISPENSERS

Both "Wax Motors" used to operate dispensers may be checked without removing from mounting bracket and dishwasher.

Connect power cord as shown, to the two terminals on wax motor. Plug power cord into 120 receptacle. Plunger in center of wax motor should "push out" and actuate dispenser in approximately 45-60 seconds.

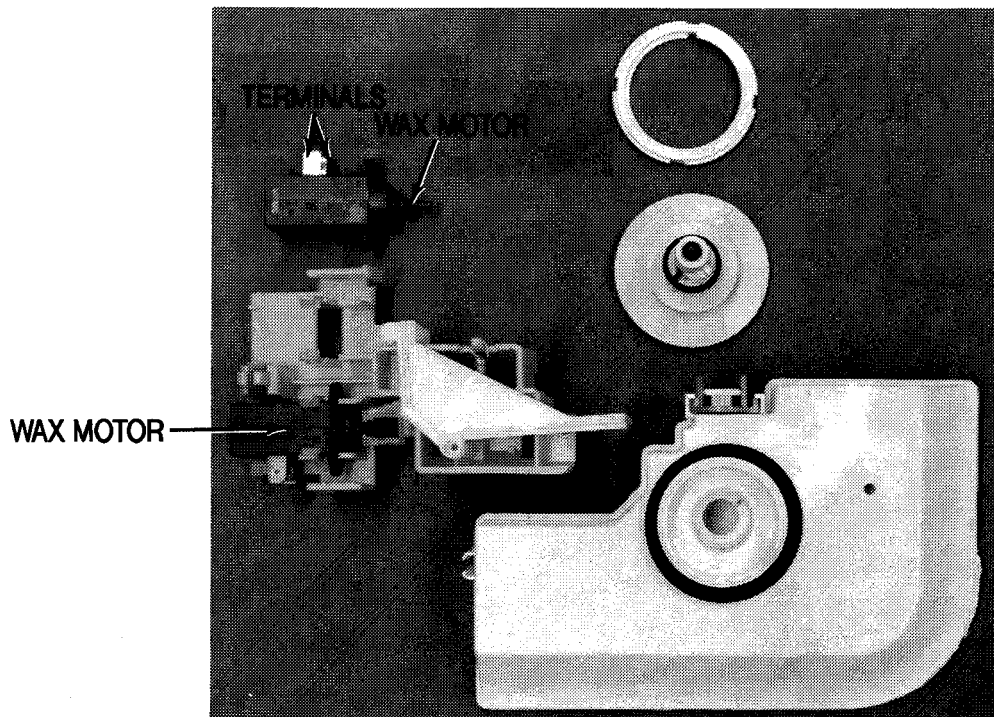

DRIVE MOTOR TEST

An external start relay and molex connector is used to couple the wire harness to the motor wires.

The start relay is mounted on the Blower Housing and consists of a coil and a switch. The coil is in series with the main winding in the motor. When the motor is first energized, the current draw in this series circuit is enough to close the switch in the start relay. This closed switch provides a path for neutral to the wash or drain start winding and depending on what part of the cycle the dishwasher is in, starts the motor in that direction. Once the motor is up to speed, the current draw decreases and the coil can no longer hold the switch closed. When the switch opens, the wash or drain start winding drops out of the circuit.

Note: The relay has to be in an upright position to work properly.

To test the motor we need to separate the molex connector. This can be done by twisting the connector side to side and pulling at the same time. The following drawings will help in making the proper connections for testing.

Note: Because of different vendors, the wires on the motor side of the molex connector may not be the same color as the wires on the wire harness side of the molex connector.

Plug test cord into properly polarized and grounded receptacle.

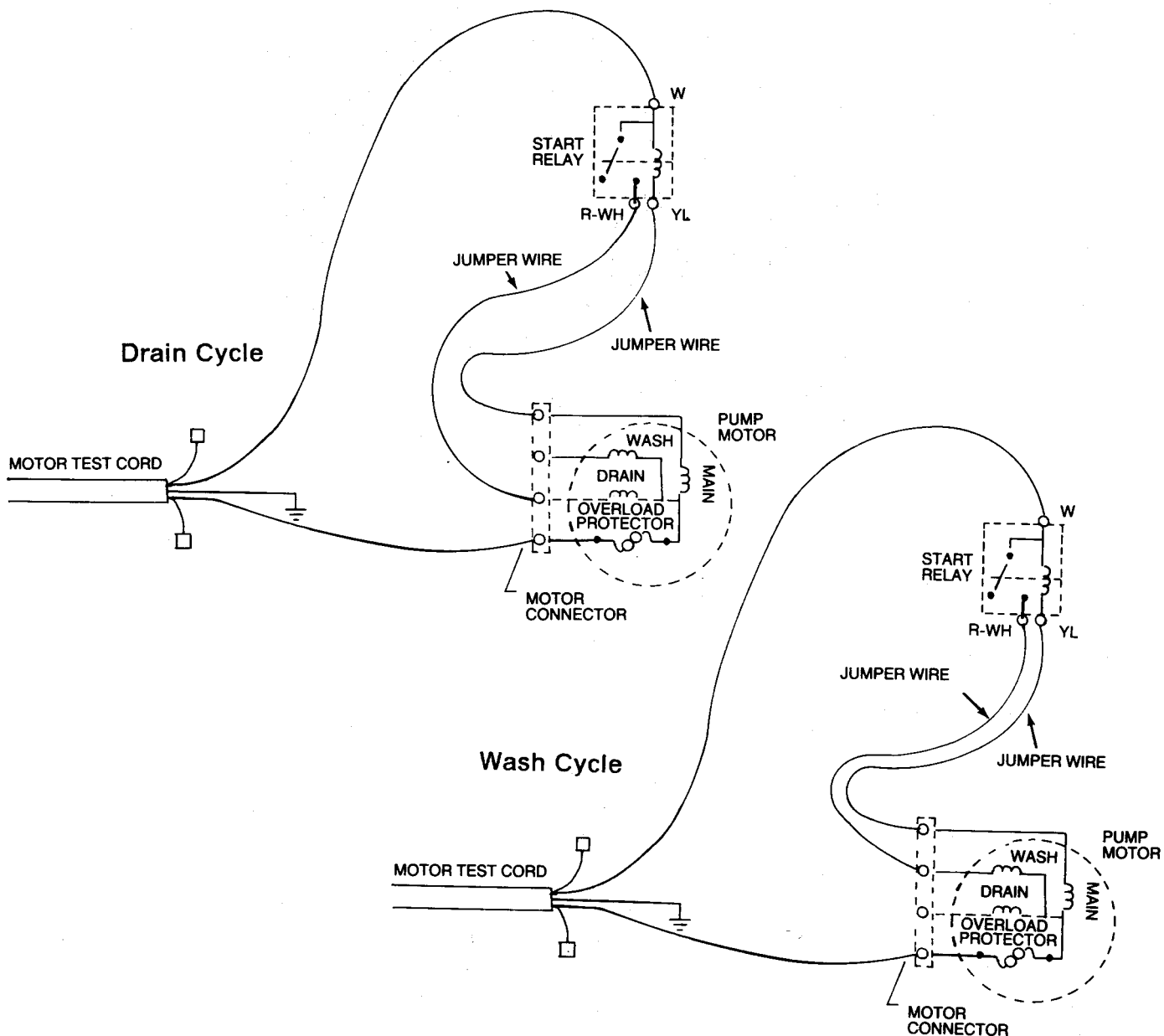

Note: DAMAGE TO THE MOTOR WILL RESULT IF THE START RELAY IS BYPASSED AND THE TEST CORD IS CONNECTED DIRECTLY TO THE MOTOR CONNECTOR.

VOLTAGE CHECKS

For the most part these checks will consist of taking readings at the wall receptacle in order to determine the availability of voltage to the product. Voltage checks on individual components of a product are not recommended due to the possibility of electrical shock. Component part testing is best accomplished through continuity checks with an **Appliance Test Meter**.

Note: Use of the meter on voltage higher than the indicated range may cause permanent damage to the meter. To prevent damage, first select highest range and then lower the range for readings which fall within the lower scale.

SET UP METER FOR USE AS FOLLOWS:

1. Turn selector knob to desired meter function and appropriate range.
2. Plug black lead into socket marked - (black).
3. Plug red lead into socket marked + (red).
4. Place test leads into receptacle in order to determine voltage available.

WATTAGES

CYCLE	WATTAGE
Circulate (Wash)	500-600
Drain	700 dropping to 200
Dry*	620-680
Power Scrub	1100-1250

*Add an average of 39 watts when blower is operating. Range 35-42.

GROUNDING & POLARITY

The receptacle used for all Maytag products operating on 120 volt AC must be properly grounded and polarized.

The power cord used on the appliances should be equipped with a three (3) prong polarized grounding plug for protection against shock hazard and should be plugged directly into a properly grounded and polarized receptacle.

Do not cut or remove the grounding prong from this plug.

It is the responsibility of the person installing the appliance to assure it is adequately grounded and polarized at the point of installation taking into consideration local conditions and requirements. In cases where only a two (2) prong receptacle is available, it is the personal responsibility of the customer to have it replaced with a properly grounded and polarized 3 prong receptacle. All grounding and wiring should be done in accordance with national and local codes. **USE OF ADAPTERS IS NOT RECOMMENDED.**

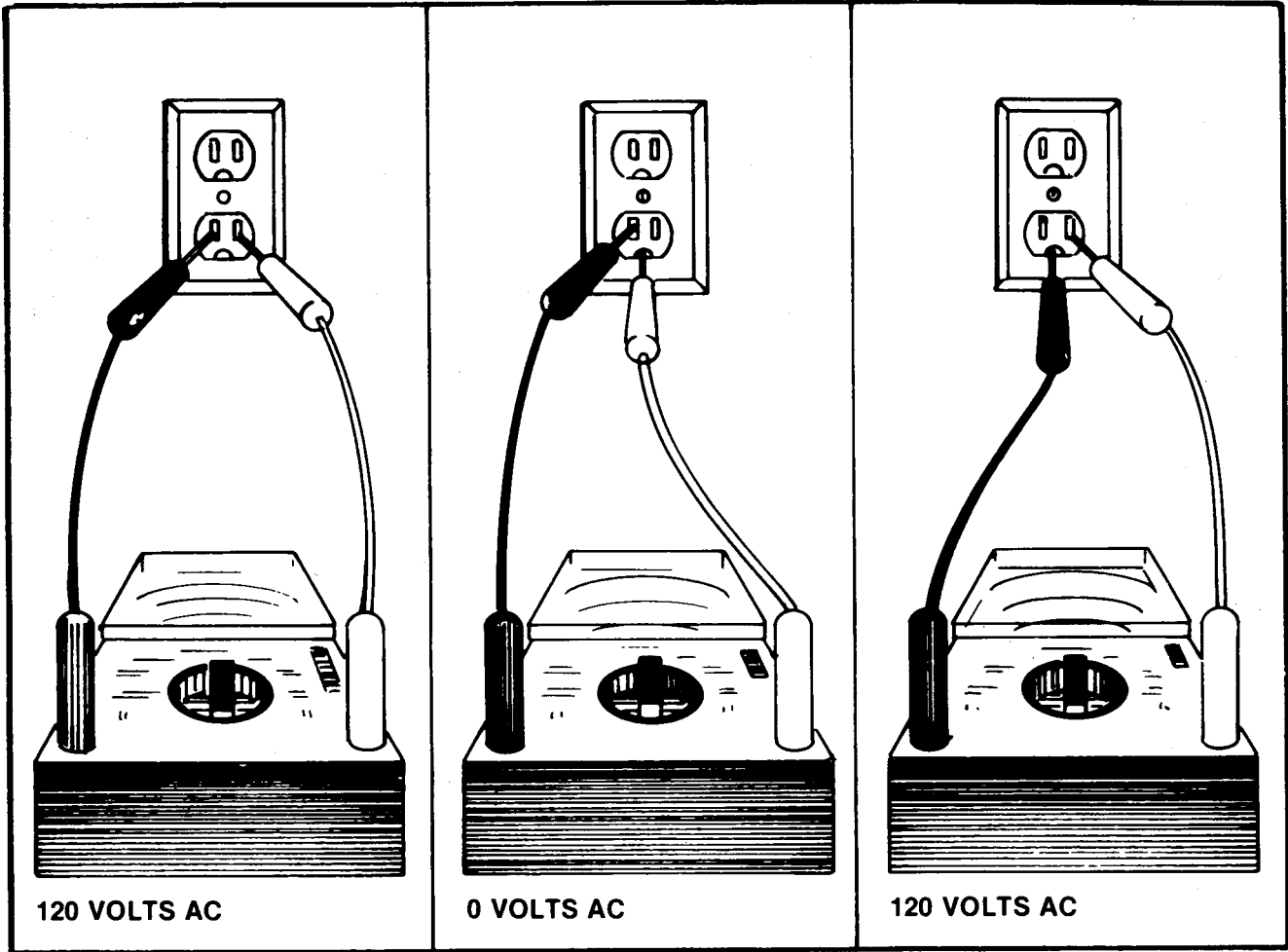

CAUTION

For your safety and to protect the test equipment, be sure that the wall outlet is properly polarized and grounded.

SECTION 2. ELECTRICAL-MECHANICAL TROUBLESHOOTING

TROUBLESHOOTING - ALL MODELS

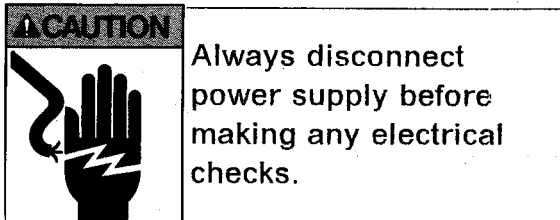

DISHWASHER WON'T FILL

Check for blown fuse or circuit breaker with voltmeter.

Be sure water is turned on and available.

Is door latched?

Check for restricted water valve screen. If screen is restricted, replace screen.

Low water pressure. Water pressure should be between 18 and 120 psi.

Check for a float stuck in the full position. Clean or replace float and float stem.

Check between door switch terminals for continuity with door closed and latched. No continuity, replace door switch.

Check between float switch terminals for continuity. No continuity, replace float switch.

Check for continuity between water valve terminals. No continuity, replace water valve.

Fill hose kinked. Remove kink.

Selector switch. Check continuity per schematic. Replace if necessary.

Timer. Check continuity per schematic. No continuity, replace timer.

DISHWASHER OVERFLOWS

Sediment build-up on float stem and float. Clean or replace float stem and float.

Float switch. With float in raised position, check for continuity between float switch terminals. If you receive continuity and float is not sticking, replace float switch.

Float switch bracket. Make sure actuator on bracket is not sticking. Clean or replace float switch bracket.

Turn electrical power on and allow dishwasher to begin to fill. While filling, turn power off. If dishwasher continues to fill with electrical power turned off, water valve is stuck open. Replace water valve.

Note: Low water pressure may result in failure of the valve to close properly.

SLOW FILL

Sediment on water valve filter screen. Clean or replace screen.

Fill hose kinked. Straighten kinked hose.

Low water pressure. Water pressure should be between 18 and 120 psi.

Water Won't Stay in Dishwasher (Siphoning)

Be sure drain hose is elevated 32". If drain hose is not elevated, elevate hose.

Drain and upper spray arm hoses are reversed. The left outlet (facing dishwasher) on the power module is for the drain hose.

Slow draining. When water is not completely drained from unit during allotted time and the next fill begins, the dishwasher will continue to drain.

Not Enough Water in Dishwasher

Dishwasher is filling too slow. See "Slow Fill".

Water is being siphoned from dishwasher. See "Water Won't Stay in Dishwasher".

WILL NOT WASH

Dishwasher Won't Circulate - Wash

Drive motor. Hook up motor test cord. If motor does not run when hooked to test cord, replace motor.

Module assembly. Repair or replace module assembly.

Selector switches. Check continuity between selector switch terminals as per schematic. No continuity, replace switch.

Timer. Check for continuity between the timer terminals required as per schematic. No continuity, replace timer.

Timer Won't Advance From Wash to Drain

Timer motor not running. Replace timer motor.

Timer. Replace timer.

Drive motor. Check for bad drain winding by operating motor on motor test cord. If dishwasher will not drain with motor test cord, replace motor and power module.

Poor Circulation

Clogged upper or lower spray arms. Clean jets. Clogged spray arms may indicate food particles are getting by the filter screen. Reseal filter if required.

Upper or lower spray arm binding.
Repair as necessary.

Low water level. Water level should be at the level of the heating element. If not, see "Dishwasher Won't Fill".

Filter screen plugged. Clean or replace screen. Also, check for binding lower spray arm.

Foreign object lodged in power module. Remove object.

Power module inoperative. Repair or replace module.

Dishes Not Coming Clean

Check to be sure dishwasher is circulating properly. If dishwasher is not circulating as intended, see "Poor Circulation".

Check to be sure detergent cup is opening. If detergent cup is not opening, see "Detergent Cup Will Not Trip".

Rinse dispenser. Check to be sure the dispenser is full. If dispenser is full, continue to next step.

Detergent Cup Will Not Trip and Rinse Additive Will Not Dispense

Make sure wires are connected to wax motors.

Be sure actuator brackets and springs are positioned correctly.

With motor test cord, check operation of wax motors as described in Electrical Test Equipment Section. Note: When

connected to 120 service direct, wax motor plunger should push out in 45-60 seconds. If wax motors work, check for circuit loss from:

Timer and wires leading to wax motors.

Or, microprocessor and wiring to wax motors.

Then check both door switches and wiring to these switches. Be sure switches are in "closed" position.

DISHWASHER WILL NOT DRAIN

Won't Drain, Will Circulate Properly

Check to be sure drain and upper spray arm hoses are not reversed. Drain hose should be at left power module outlet (facing dishwasher).

Drive motor. Hook up motor test cord. If motor will not operate with test cord, replace drive motor and power module.

Timer. Check for continuity with timer set in drain cycle between timer terminals as per schematic. No continuity, replace timer.

Selector switch. Check for continuity between switch terminals as per schematic. No continuity, replace switch.

Check for an object lodged between drain impeller and power module. Remove object and replace any damaged components.

Drain hose kinked or restricted. Remove restrictions and reroute drain hose.

Hose drain is plugged. Have drain cleaned.

Module assembly damaged. Repair or replace power module assembly.

Slow Drain

Drain hose kinked or restricted. Reroute drain hose and remove any restrictions.

Inadequate hose drain. House plumbing should be checked and repairs done as recommended.

Dishwasher Tries to Drain, Motor Shuts Off on Overload Protector

Check line voltage when dishwasher begins to drain. If voltage drops below 105 volts, have house wiring checked.

Module assembly locked. Repair or replace power module assembly.

Drive motor. Replace drive motor and power module or start relay.

Dishwasher Won't Advance From Drain to Off

Timer motor. Determine if timer motor is operating. If timer motor is not operating, replace timer motor.

Timer motor is running, but timer will not advance, replace timer.

DISHES WILL NOT DRY

Dishwasher Won't Dry

Low water temperature. Water temperature should be between 140°F and 150°F. If water temperature is below 140°F turn water heater up.

Check for damaged blower and blower impeller. Repair as necessary.

Blower motor. Check for continuity between blower motor terminals. No continuity, replace blower motor.

Check vent flapper to make sure it is moving freely inside vent on door.

Rinse additive. Make sure rinse additive is being used to assist in sheeting of water. Also refer to "Detergent Cup Will Not Trip and Rinse Additive Will Not dispense".

Timer. Check for continuity per electrical schematic checks. No continuity, replace timer.

Selector switch. Check for continuity between selector switch terminals as per electrical schematic. No continuity, replace selector switch.

Heating element. Check for continuity between heating element terminals. No continuity, replace heating element.

Thermostat. On select models check for continuity between thermostat terminals with thermostat in closed position. No continuity, replace thermostat.

DISHWASHER LEAKS

Be sure all hose clamps are tight. Tighten any loose clamps.

Blower. Check for leaks around blower. Make sure blower valve is reseating properly. Replace blower valve if necessary.

Inlet, drain or upper spray arm hose leaking. Replace hose that is leaking.

Weep hole in module leaking. Water leak from weep hole would indicate possible problem with O-ring seal or boot seal in module. Replace seals.

Check to be sure there are no holes in module housing. Replace power module assembly.

Module gasket. Check for leak between module assembly and tub. If gasket is leaking, replace gasket.

Water valve. If water valve body is leaking, replace water valve.

Door gasket. Check for proper door latch adjustment. If latch is adjusted properly, check for torn or damaged door gasket. Replace gasket if torn or damaged.

Check gasket between lower spray arm and module assembly. If out of position or damaged, reposition or replace.

Upper or lower spray arm cracked. Check and replace if necessary.

Check for proper door alignment and door latch adjustment.

Make sure unit is leveled properly. If back is higher than front, water can leak out around door gasket.

DISHWASHER NOISY

Before servicing unit, check to be sure noise is not normal operating sound.

Chattering. Replace water valve.

Banging. Loose upper or lower spray arms. Replace fastener holding upper spray arm to upper spray arm support. Tighten spray nozzle for lower spray arm.

Ticking during dry cycle. Object caught in blower impeller or impeller is loose on shaft. If impeller is loose, secure impeller to shaft with a small amount of Loc-Tite.

Thumping or banging. Object in path of spray arm. Remove object.

Thumping. Object in power module, remove it.

Humming. Water valve solenoid. Replace water valve.

Buzzing timer. Replace timer or timer motor if buzzing is severe.

WATER PIPES VIBRATING (WATER HAMMER)

Water valve. Anti-water hammer device in valve has failed. Replace valve.

Check for loose water pipes. Secure pipes if loose.

TROUBLESHOOTING - MICROPROCESSOR MODELS

Following are Electrical checks for the Microprocessor models. For Mechanical checks refer to respective section covering all dishwashers.

WILL NOT PROGRAM (MODELS WITH DISPLAY WINDOW)

Depress "ON" pad. Display should read flashing "0". Depress cycle selection pad. Display should show correct number of minutes for the cycle selected (see Cycle Chart). If either does not occur check the following.

Varistor If visual inspection shows damage varistor, transformer should be checked. If transformer checks okay the varistor should be replaced.

Transformer Check primary coil, BLK to WHITE and secondary coils RD-BLK to RD-BLK and BLU-BLK to BLU-BLK. No continuity on any check, replace transformer.

Door Switch - 24 volt With door latched should show continuity BROWN to WHITE. No continuity, replace switch.

Microprocessor Replace.

Touch Pad If above components check okay and unit still won't program, replace touch pad.

WILL NOT FILL

Make sure unit is programmed. See "Will Not Program".

Float Switch Check for continuity (OR to OR) between float switch terminals. No continuity, replace switch.

Water Valve Check coil (OR to WHITE) for continuity. No continuity, replace water valve.

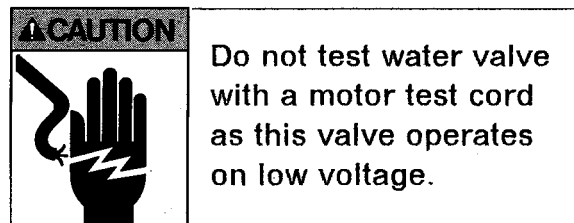

Microprocessor Replace. Refer to respective section covering all dishwashers for mechanical checks.

Hot Water Temperature Too Cool

Thermostat Check for continuity between thermostat terminals. No continuity, replace thermostat.

Heating Element Check for continuity between heating element terminals. No continuity, replace heating element.

Microprocessor Replace.

Touch Pad If LED indicator does not light when "Power Scrub" is selected and microprocessor checks okay, replace touch pad.

Refer to respective section covering all dishwashers for mechanical checks.

Dishwasher Overflows

Float Switch With float in raised position check for continuity, ORANGE to ORANGE, between switch terminals. Continuity should NOT be seen; if noted, replace float switch.

Refer to respective section covering all dishwashers for mechanical checks.

Slow Fill

Refer to respective section covering all dishwashers for checks.

Water Won't Stay in Dishwasher (Siphoning)

Refer to respective section covering all dishwashers for checks.

WILL NOT WASH

Door Switch - 120 volt With door latched check for continuity between switch terminals, BLACK to BLACK. No continuity, replace 120 volt door switch.

Motor Direction Relay Replace microprocessor board.

Motor Relay Replace microprocessor board.

Drive Motor Hook up motor test cord. See section on Electrical Testing Equipment. If motor does not run when hooked to the test cord, replace motor and power module.

Microprocessor Replace.

Refer to respective section covering all dishwashers for mechanical checks.

DETERGENT CUP WILL NOT TRIP

Wax Motor

Refer to respective section covering all dishwashers for mechanical checks.

Microprocessor Replace.

RINSE DISPENSER WON'T WORK

Wax Motor Refer to respective section covering all dishwashers for mechanical checks.

Rinse Dispenser Relay Replace microprocessor board.

Microprocessor Replace.

Refer to respective section covering all dishwashers for mechanical checks.

DISHWASHER WILL NOT DRAIN

Drive Motor Hook up motor test cord, see section on Electrical Testing Equipment. If motor will not operate with test cord, replace motor and module assembly.

Motor Start Relay Replace microprocessor board.

Microprocessor Replace.

Refer to respective section covering all dishwashers for mechanical checks.

Slow Drain

Refer to respective section covering all dishwashers for mechanical checks.

Dishwasher Tries to Drain, Motor Shuts Off on Overload Protector

Refer to respective section covering all dishwashers for mechanical checks.

DISHWASHER WILL NOT DRY

Thermostat Check for continuity between thermostat terminals. No continuity, replace thermostat.

Heating Element Check for continuity between heating element terminals. No continuity, replace heating element.

Blower Motor Check for continuity between blower motor terminals, WHITE to PURPLE. No continuity, replace blower motor.

Blower Relay Replace microprocessor board.

Microprocessor Replace.

Touch Pad If LED indicator does not light when "Power Dry" is selected and microprocessor checks okay, replace touch pad.

Refer to respective section covering all dishwashers for mechanical checks.

ELECTRICAL TEST - MICROPROCESSOR MODELS

The control of the dishwasher is accomplished through the microprocessor board in conjunction with the transformer, control relays and thermostat (boost). The microprocessor board controls the functions of the dishwasher. The transformer provides the necessary voltage(s) to operate the microprocessor board. The control relays function as switches to give the microprocessor board control of the individual components (motor, heater, detergent dispenser, water valve, blower and rinse dispenser). The thermostat (boost) provides the control mechanism for a desired water temperature.

The user programs the dishwasher cycle by pressing the indicated pads on the menu. Behind the menu are actuators (seven or eight depending on the model) that when pushed, input information to the microprocessor board by physically activating switches on the microprocessor board.

Note: The pads are all inactive with the door unlatched.

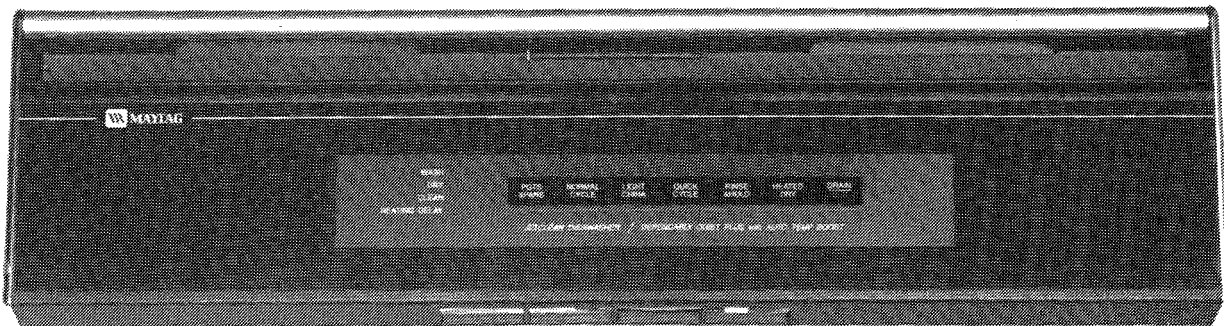
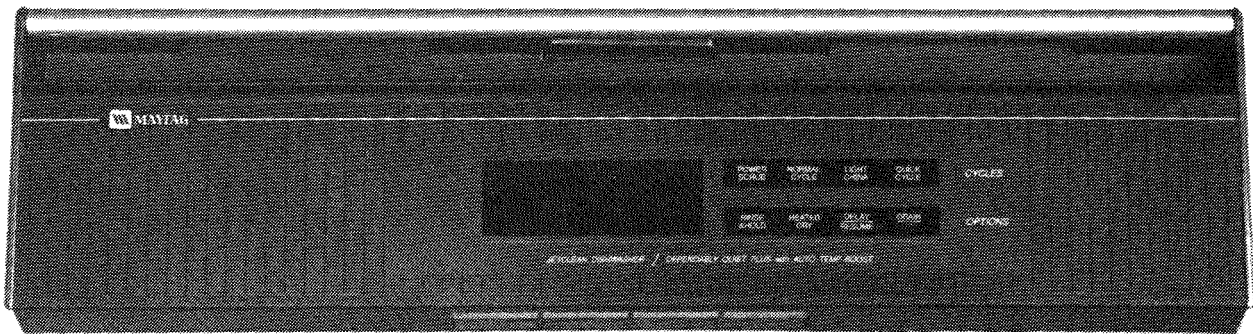

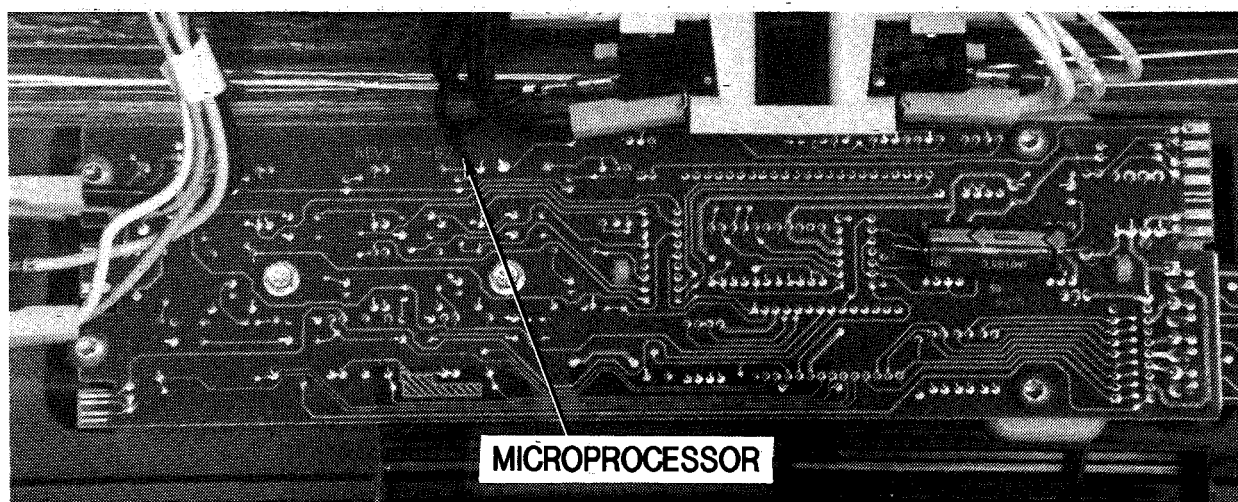
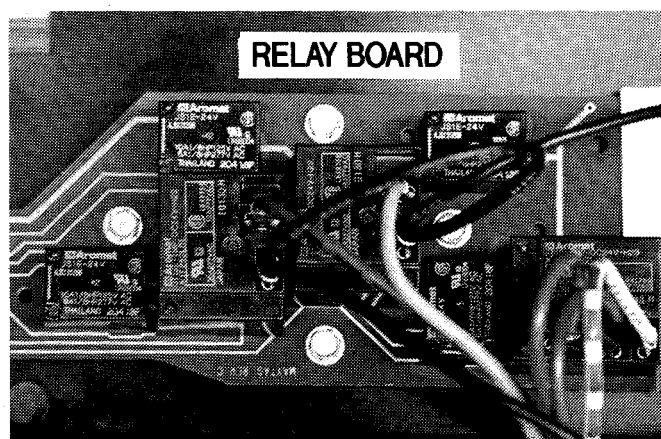
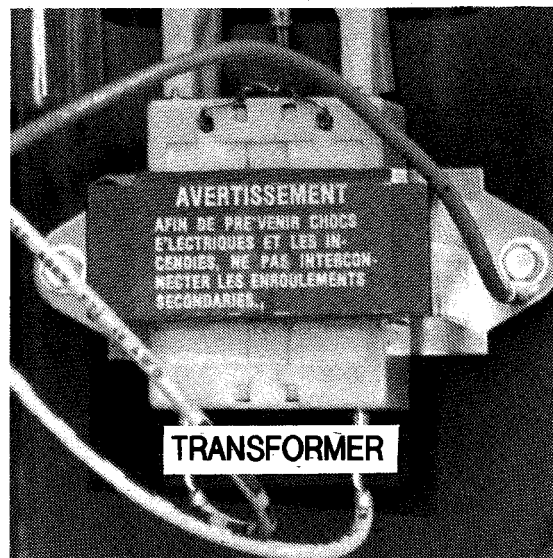
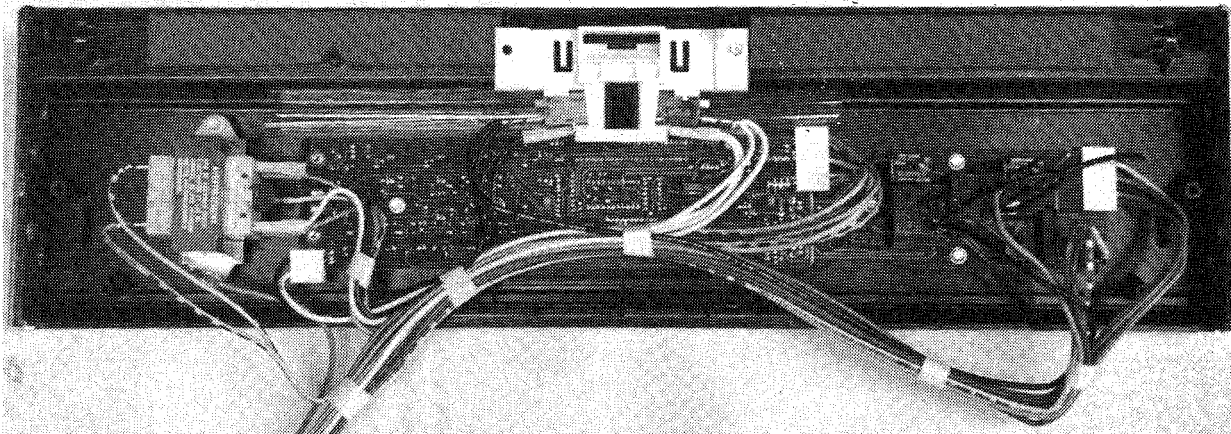

The following operating information about the display window, options and functions is covered by model number.

DWU9920

The dishwasher is activated by pressing any cycle pad on the menu display. All cycles begin with a 5 second pause to allow for selection time. The indicator light above the pad will glow and a short beep will sound indicating the dishwasher control has responded to the selection. When the cycle pad is pressed, the cycle length, in minutes, will appear in the display.

CYCLE SETTING	SEQUENCE	APPROX. CYCLE TIME	WATER USE
RINSE & HOLD: Use to rinse a relatively few soiled dishes which are to be held until the dishwasher is full. Press Rinse & Hold pad.	Rinse	5 Min.	2 Gal.
QUICK CYCLE: Use to quickly wash dusty or very lightly soiled dishes you wish to store or reuse immediately. Press Quick Cycle pad.	Wash 2 Rinses Heat Dry	17 Min. 35 Min.-Heat Dry (Optional)	5 Gal.
LIGHT/CHINA: Use for china and crystal and for loads containing medium to light amounts of soil. Press Light/China pad.	Rinse Main Wash 2 Rinses Dry	41 Min. <u>35 Min.-Dry</u> 76 Min.	7 Gal.
NORMAL CYCLE: Use for washing loads containing normally soiled dishes. This would include dishloads with problem soils. Press Normal Cycle pad.	PreWash Rinse Main Wash 2 Rinses Dry	49 Min. <u>35 Min.-Dry</u> 84 Min. + Heating Delay*	9 Gal.
POWER SCRUB: Use for loads with heavy or dried soils. Press Power Scrub pad.	PreWash 2 Sani Rinses Main Wash 2 Sani Rinses Dry	70 Min. <u>35 Min.-Dry</u> 105 Min. + Heating Delay*	11 Gal.

*The AUTO TEMP BOOST feature may extend the main wash (up to 10 additional minutes) to heat the water to proper temperature. The HEATING DELAY indicator will light when the cycle is being extended due to low water temperatures.

In the display window, the six segment vertical bar and words represent the length of the cycle and what phase of the cycle is in progress; "PRE-WASH, WASH, RINSE or DRY". "CLEAN" will appear in the display from the beginning of the dry phase until the door is unlatched for longer than 30 seconds.

SPECIAL INDICATORS

RINSED ONLY - appears after a Rinse & Hold cycle.

HEATING DELAY - appears only at the end of the main wash of Normal Cycle or Power Scrub when the water temperature is low. The Auto Temp Boost Sensor extends the wash (up to 10 additional minutes) to heat the water.

DELAY - appears when the Delay/Resume pad is pressed to show the time length of the delay.

PF - appears when there has been a power failure. Press any pad to clear.

DRY OPTIONS

HEATED DRY - Select this option to provide heat during the fan dry cycle. A small indicator light above the pad will glow when it is selected.

Cancel Heated Dry by pressing the pad again. No heat will be provided, but the fan will still operate. The dry portion can be changed anytime the dishwasher is on and the door is latched.

Cancelling the Heated Dry option on the Quick Cycle will eliminate the dry portion entirely in order to shorten the cycle. The load will need to be towel dried.

Note: The dishwasher features an option recall which memorizes the option selected with a cycle. If Heated Dry is selected with a particular cycle, it will be recalled automatically the next time that cycle is selected.

SPECIAL FUNCTIONS

DRAIN/OFF - When Drain/Off pad is pressed, "2 MIN." will appear in the display and the dishwasher will drain for approximately 2 minutes.

To cancel a cycle without draining, press the Drain/Off pad twice. This will turn the dishwasher off.

DELAY/RESUME - Pressing the Delay/Resume pad can delay or interrupt any cycle from 10 minutes to 12 hours.

To set up a delay press the Delay/Resume pad, holding it down until the desired amount of delay time appears in the display. When first pressed, 10 MIN. will appear and increase in 10 minute increments until 1 HOUR appears.

Further increases in the display will be in one hour increments until 12 hours is reached. Now select a cycle and dry option. The dishwasher will automatically start as soon as the delay time expires.

DELAY will remain in the display until the clock has counted down. Delay can be cancelled by pressing the Delay/Resume pad a second time. The cycle selected will begin immediately.

This feature can also be used to temporarily interrupt a cycle. The cycle will resume from the point of interruption when the delay time runs out or when the Delay/Resume pad is pressed again.

DWU9905/DWU8890

To start the dishwasher, press the pad corresponding with the chosen cycle on the menu. A small indicator light above the pad will glow to indicate the control has responded to the selection. Cycles or options can be selected in any order; but if a cycle has not been selected within 10 seconds of the last option selection, the options will be cancelled. The cycle will not time out if the door is not latched.

CYCLE SETTING	SEQUENCE	APPROX. CYCLE TIME	WATER USE
RINSE & HOLD: Use to rinse a relatively few soiled dishes which are to be held until the dishwasher is full. Press Rinse & Hold pad.	Rinse	5 Min.	2 Gal.
QUICK CYCLE: Use to quickly wash dusty or very lightly soiled dishes you wish to store or reuse immediately. Press Quick Cycle pad.	Wash 2 Rinses Heat Dry	17 Min. 35 Min.-Heat Dry (Optional)	5 Gal.
LIGHT/CHINA: Use for china and crystal and for loads containing medium to light amounts of soil. Press Light/China pad.	Rinse Main Wash 2 Rinses Dry	41 Min. 35 Min.-Dry 76 Min.	7 Gal.
NORMAL CYCLE: Use for washing loads containing normally soiled dishes. This would include dishloads with problem soils. Press Normal Cycle pad.	PreWash Rinse Main Wash 2 Rinses Dry	49 Min. 35 Min.-Dry 84 Min. + Heating Delay*	9 Gal.
POTS & PANS: Use for loads with heavy or dried soils. Press Pots & Pans pad.	PreWash 2 Sani Rinses Main Wash 2 Sani Rinses Dry	64 Min. 35 Min.-Dry 99 Min. + Heating Delay*	11 Gal.

*The AUTO TEMP BOOST feature may extend the main wash (up to 10 additional minutes) to heat the water to proper temperature. The HEATING DELAY indicator will light when the cycle is being extended due to low water temperatures.

INDICATOR LIGHTS

The **WASH** light will glow during all washes and rinses.

The **DRY** light will be on during the entire dry period (with heat on or off) and goes out when the cycle is completed.

The **CLEAN** indicator light will glow from the beginning of the dry phase and remain on until the door is unlatched for 30 seconds.

The **HEATING DELAY** light will glow only at the end of the main wash of the Normal or Pots & Pans cycles when the water temperature is low. The Auto Temp Boost feature extends the wash (up to 10 additional minutes) to heat the water.

DRY OPTIONS

HEATED DRY Select this option to provide heat during the fan dry cycle. A small indicator light above the pad will glow when it is selected.

Cancel Heated Dry by pressing the pad again. No heat will be provided, but the fan will still operate. The dry option can be changed anytime the dishwasher is on and the door is latched.

Cancelling the Heated Dry option on the Quick Cycle will eliminate the dry portion entirely in order to shorten the cycle. The load will need to be towel dried.

Note: The dishwasher features an option recall which memorizes options selected with a cycle. If options are used with a particular cycle, they will be recalled automatically the next time that cycle is selected.

SPECIAL FUNCTIONS

DRAIN OFF - When the Drain/Off pad is pressed, the dishwasher will drain for approximately 2 minutes.

To cancel a cycle without draining, press the Drain/Off pad twice. This will immediately turn the dishwasher off.

ELECTRICAL TROUBLESHOOTING - MICROPROCESSOR MODELS

The control circuit consists of the transformer, microprocessor board, control relays(s) and the thermostat (boost), if that option is selected. The controlled circuit will contain the components involved with the actual washing, rinsing and drying operations of the dishwasher: the pump motor, heater, detergent dispenser, water valve, rinse dispenser and blower. Refer to the schematic to determine what is involved in each circuit.

The control circuit is the circuit that should be checked first if the dishwasher fails to operate (assuming power is available to the dishwasher). Trouble shooting this circuit is made easier by understanding how each component of the circuit functions: the transformer provides the voltage to operate the microprocessor board, the microprocessor board completes the circuits to the relays for the "control" voltage and the relays provide the mechanism to control the individual components involved in the washing, rinsing and drying operations. The thermostat (boost) provides the control for the desired water temperature in the tub.

TRANSFORMER

Two different transformers are used with these dishwasher models. Refer to the parts catalog to determine which transformer is used on the model in question. The only difference between the two transformers is the number of secondary windings on the secondary side of each transformer. One transformer has two secondary windings and the other transformer has only one secondary winding. Both transformers are step-down transformers and each consists of a varistor, primary side and secondary side. If the dishwasher fails to function, the transformer should be checked first, as it is the component that powers the microprocessor board.

PRIMARY SIDE

The primary side of the transformer contains the varistor and the primary winding. The function of the varistor is to protect the microprocessor board from voltage surges or spikes. It is a semiconductor device designed so its resistance will decrease as the voltage across it increases. If the voltage across the varistor reaches its threshold point, it will act as a short across the primary winding of the transformer and open the circuit breaker or fuse and may destroy itself. If the varistor is damaged, replace the transformer.

The primary winding is the winding on the transformer that receives the input voltage from the power supply, 120 VAC as measured across L1 and Neutral.

Removing The Transformer

The transformer is located behind the control panel. Refer to Control Panel in Service Procedures section.

1. Disconnect the wires from the transformer.
2. Remove the two screws securing the transformer to the control panel.

Checking The Primary Winding

1. Check for continuity across primary winding.

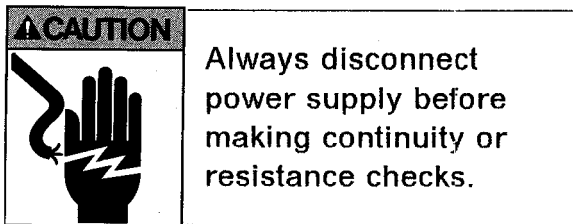

- A. Disconnect dishwasher from power supply.
 - B. Gain access to transformer.
 - C. Remove wires BK and WH from the primary winding.
 - D. Place ohmmeter leads on these two terminals and make check. No continuity, replace transformer.
2. Check for 120 VAC across the primary winding.

USE EXTREME CAUTION WHEN CHECKING VOLTAGE.

- A. Connect dishwasher to power supply.
- B. Place volt meter leads on the BK and WH wires and make check. If reading is suspect, check power supply.

SECONDARY SIDE

The input voltage on the primary winding is stepped-down by the secondary winding(s) to the voltage(s) necessary for the operation of the microprocessor board.

Checking the DWU9920 Transformer (2 secondary windings)

1. Check for continuity across secondary windings.

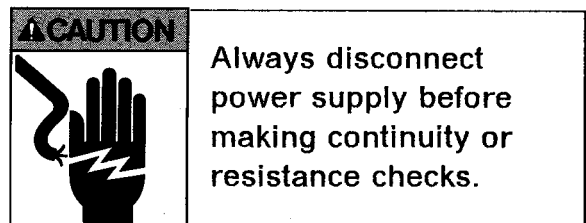

- A. Disconnect dishwasher from power supply.
 - B. Gain access to transformer.
 - C. Remove BU-BK, YL and BU-BK wires from secondary winding.
 - D. Place ohmmeter leads on terminals, BU-BK and BU-BK and make check. Move ohmmeter lead from one of the BU-BK terminals to the YL terminal and make check. No continuity on either check, replace transformer.
 - E. Remove wires Y-BK and Y-BK from secondary winding.
 - F. Place ohmmeter leads on these terminals and make check. No continuity, replace transformer.
2. Check for voltage across secondary windings.

USE EXTREME CARE WHEN CHECKING VOLTAGE.

- A. Connect power supply.
- B. Place volt meter leads on terminals BU-BK and BU-BK. Make check, voltage should read 3.8 VAC.
- C. Check from either of the BU-BK terminals to the YL terminal. Should see about 1.9 VAC (may be difficult to read with analog meter).
- D. Place volt meter leads on terminals Y-BK and Y-BK. Make check, should read 21 VAC. NOTE: Voltages may vary. If voltage readings are suspect, check primary winding or power supply.

B. Place volt meter leads on terminals BU-BK and BU-BK. Make check, should read 21 VAC. Note: Voltage may vary. If voltage reading is suspect, check primary winding or power supply.

Checking The DWU9905/DWU8890 Transformer (1 secondary winding)

1. Check for continuity across secondary winding.

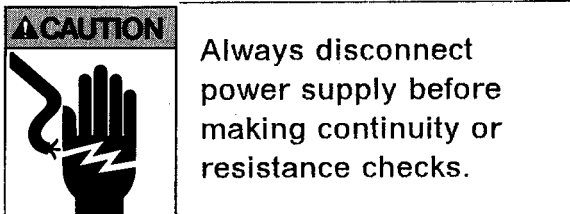

- A. Disconnect dishwasher from power supply.
 - B. Gain access to transformer.
 - C. Place ohmmeter leads on these terminals. Make check, no continuity, replace transformer.
2. Check for voltage across secondary winding.

USE EXTREME CAUTION WHEN CHECKING VOLTAGE.

- A. Connect power supply.

MICROPROCESSOR BOARD

FIELD SERVICE TEST

The following tests can be used to determine if a component is functioning. All of the control relays are energized at some point during the test. Some of the relays are energized long enough to physically verify that the component is functioning correctly. An example of this is the water valve relay which is on for 100 seconds. The test sequence shows when the component in question is energized. Placing an ammeter around one of the wires (from either the L1 or Neutral side) will indicate if that component is energized during the test. If further testing is required, refer to the section in the dishwasher manual covering that component.

Products that have a single row of buttons: the sequence of keys to initiate the field service test starts by pushing the far left key, then pushing every key moving to the right, and ends by pushing the Rinse & Hold key. This equates to the following sequence: Pots & Pans, Normal Cycle, Light/China, Quick Cycle, Rinse & Hold, Heated Dry, Drain/Off and then Rinse & Hold.

Products that have two rows of buttons: the sequence of keys to initiate the field service test starts by pushing the upper far left key, then pushing all of the top row off keys moving to the right, then pushing all of the bottom row of keys from left to right, and ends by pushing the Rinse & Hold key. This equates to the following sequence: Power Scrub, Normal Cycle, Light/China, Quick Cycle, Rinse & Hold, Heated Dry, Delay, Drain/Off and then Rinse & Hold.

The test proceeds as follows:

1	10 secs	HEATER WITH ALL LEDS ON.
2	10 secs	BLOWER WITH POTS & PANS LED ON.
3	100 secs	FILL & RINSE DISPENSER WITH NORMAL CYCLE LED ON.
4	100 secs	WASH & DETERGENT DISPENSER WITH LIGHT/CHINA LED ON.
5	100 secs	DRAIN WITH ALL LEDS OFF.

RAPID TIMEDOWN MODE

The rapid timedown function is entered by holding down the active cycle key for more than two seconds and then simultaneously holding down the heated dry key. Each flash of the LEDs indicates one minute of elapsed cycle time. The relays (except the drain relay) will remain off until the keys are released.

CLEAN/RINSED ONLY INDICATION DEMONSTRATION MODE

By holding down on one of the cycle keys for more than 2 seconds and then pushing the Drain/Off key simultaneously, the cycle will end immediately with "CLEAN" or "RINSED ONLY", as appropriate, in the display.

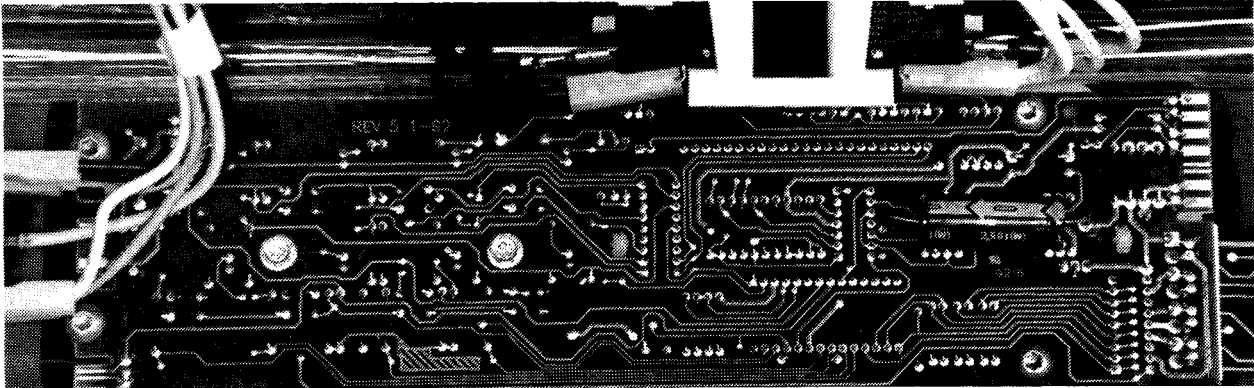

To Remove Microprocessor Board

1. Disconnect dishwasher from power supply.
2. Gain access to microprocessor board (refer to "Removing the Transformer").
3. Remove edgeboard connectors.
4. Remove the four screws securing the microprocessor board to the control panel.
5. Disconnect the microprocessor board from the relay board.

CONTROL RELAYS

There are several control relays used on each of the microprocessor board controlled models. They are mounted on a printed circuit board that is attached to the control panel and connected to the microprocessor board via an edgeboard connector. Two different types of relays are found on each printed circuit board. Four of the relays make direct contact with the printed circuit board for their low voltage circuit (25 VDC) and have external terminal connections on top of the relay for their high voltage circuit (120 VAC). The other three relays make direct contact with the printed circuit board for both their low and high voltage circuits.

Note: If a relay on the board fails, the relay board itself will have to be replaced, as the individual relays are not replaceable.

The relays provide the means of control for the microprocessor board. By placing the switching contacts in the relay in series with a functional component, such as the heater, the microprocessor board is able to control the operation of that component. It does this by closing or opening the control voltage circuit (25 VDC) to the coil in the relay from the microprocessor board. Each of the relays is an electromagnetic relay. When the coil in the relay is energized with 25 VDC from the microprocessor board, it creates a magnetic field that closes the switch contacts in the relay. When these contacts close, the functional component is connected across the controlled voltage (120 VAC) and becomes energized, i.e. the heater comes on.

The exception to this is the Motor Direction Relay. It functions as a S.P.D.T. switch to provide a path for Neutral (assuming polarity is correct) to the Wash or Drain windings of the Pump Motor when the Start Relay is energized. Without 25 VDC applied to the coil in the Motor Direction Relay, the closed set of contacts in the relay is in series with the Wash Winding. When 25 VDC are applied to the coil, the other set of contacts is placed in series with the Drain Winding (refer to schematic). When the Main Winding in the Pump Motor is energized, the current surge through the coil in the Start Relay is enough to close the switch contacts in the Start Relay. In doing so, this completes a path for current flow through the Motor Direction Relay to either the Wash or Drain winding and starts the motor rotating. As the Pump Motor comes up to speed, the current draw decreases to a point where the contacts in the Start Relay are no longer held closed and the Wash or Drain winding drops out of the circuit.

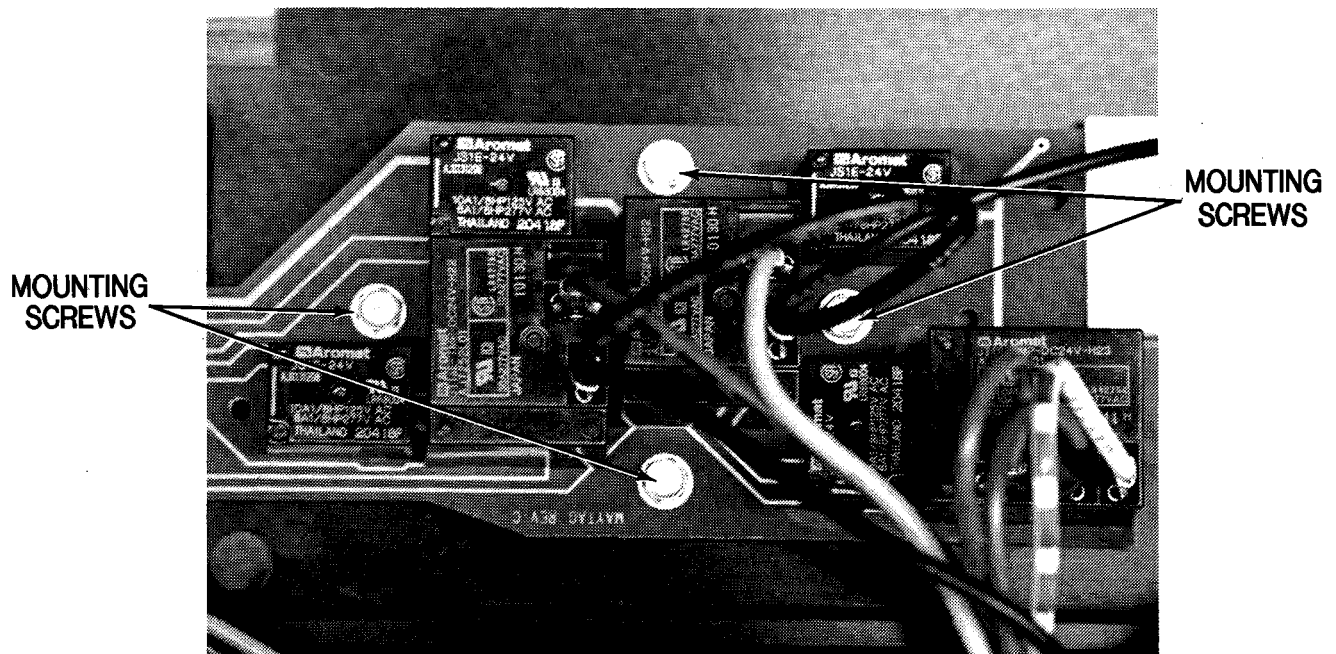

RELAY BOARD

The relays are mounted on the printed circuit board. The relay board is mounted to the control panel. If a dishwasher function fails to operate, such as no water entering the dishwasher, the relay responsible for that function should be checked.

Removing the Relay Board

1. Disconnect the dishwasher from the power supply.
2. Gain access to the relay board.
3. Disconnect the edgeboard connector from the relay board.
4. Disconnect the external wires from the relays.

5. Remove the four screws that secure the relay board to the control panel.
6. Remove the relay board from the edgeboard connector on the micro-processor board.

Check the Relay Board

Check for continuity across relay coil.

1. Remove relay board from dishwasher. Refer to "Removing the Relay Board".
2. Continuity checks can be made at the connection where the relay board is attached to the micro-processor board.
3. Place one of the ohmmeter leads on the 24 VDC connection on the relay board (refer to Relay Board Wiring Guide). The 24 VDC connection is common to all the relays.
4. Attach the other ohmmeter lead to the connection that goes to the other side of the relay coil.
5. Make check. No continuity, replace relay board.

THERMOSTAT (BOOST)

This thermostat is used to control the temperature of the water in the dishwasher tub for the main wash when the Power Scrub or Auto Temp Boost option is selected. The thermostat is mounted so that it senses the temperature of the dishwasher tub and not the temperature of the water inside the tub. It is part of the low voltage circuit. A circuit is made from the 24 VDC connection on the microprocessor board, through the relay board to the thermostat and back to the microprocessor board. Refer to schematic.

To Remove The Thermostat

1. Disconnect the dishwasher from the power supply.
2. Remove the four screws that secure the access panel to the dishwasher. Remove the access and toe panel.
3. The thermostat is secured to a thermostat bracket by a clip. The bracket is located behind the terminal box and is mounted against the tub.

To Check Thermostat

Check for continuity.

1. Remove thermostat.
2. Disconnect GY and BR wires.
3. Attach ohmmeter leads across these terminals.
4. Make check. At room temperature there should not be continuity across the terminals. If check shows continuity, replace thermostat.

LIMITING THERMOSTAT

The Limiting Thermostat is connected in series with the heater (refer to schematic) and will open that circuit if something happens that causes overheating of the water to occur. It also senses the temperature of the dishwasher tub as the water is being heated. The thermostat is secured to a thermostat bracket by a clip. The bracket is located behind and mounted to the terminal box. The procedure for removing this thermostat is the same as the procedure for removing the thermostat boost.

To Check Thermostat

Check for continuity.

1. Remove thermostat.
2. Disconnect Y-BK and R-BK wires from thermostat.
3. Attach ohmmeter leads across these terminals. Make check. At room temperature there should be continuity across terminals. If check indicates no continuity, replace thermostat.

DETERGENT & RINSE AID DISPENSERS

Detergent and Rinse Aid dispensers operate by energizing "Wax Motors" which receives signal from microprocessor board. Relays mounted on microprocessor board control dispenser operation. (See Test Section for Dispensers.)

If power is not supplied to dispenser wax motors from microprocessor, replace microprocessor.

SECTION 3. SERVICE PROCEDURES

OUTER DOOR PANEL

To Change Panels

1. Remove three screws holding the metal trim strip on one side of the door. Take note of how the trim comes off.
2. Grasping the lower part of the door panels, bow panels out carefully at the bottom while sliding panels far enough to clear the flange on the trim strip which was not removed and remove panels.
3. Arrange panels so the desired color is facing out.
4. Place door panels (notched side up) behind the metal trim at the bottom of the door. Bow the panels so they fit behind the control panel at the top.
5. Slide the panels under the side metal trim which was not removed. To do this, it will be necessary to compress the backing behind the colored panels.
6. Reinstall the metal trim which was removed earlier. To do this, start by inserting the tip end of the trim strip behind the control panel. Align the holes and replace the three screws.
7. The lower access panel is held by four screws (two above the panel and two below). With these removed, the panel may be removed to make it easy to change panel colors.
8. With the lower access panel removed, remove the four screws

along the bottom of panel and remove the trim which holds the panels. Once the desired panel is facing out, replace the trim and reinstall the panel to the dishwasher.

ACCESS AND TOE PANELS

Remove access and toe panels by taking out (4) hex head screws.



INNER DOOR PANEL

For access to dispensers and wiring, it is necessary to remove the inner door panel. The door latch assembly is also located behind this panel.

To Remove

1. Open the dishwasher door.
2. Remove torx screws from outer frame of door. Also, remove screw securing switch and latch assembly in position.

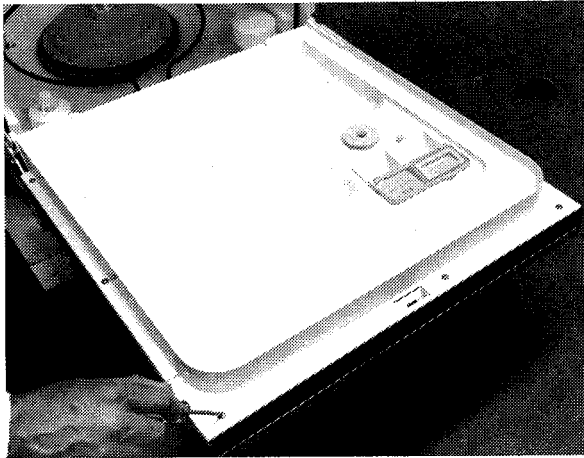

3. Unscrew rinse aid cap and set aside.
4. Remove retainer nut holding rinse aid dispenser to inner panel.

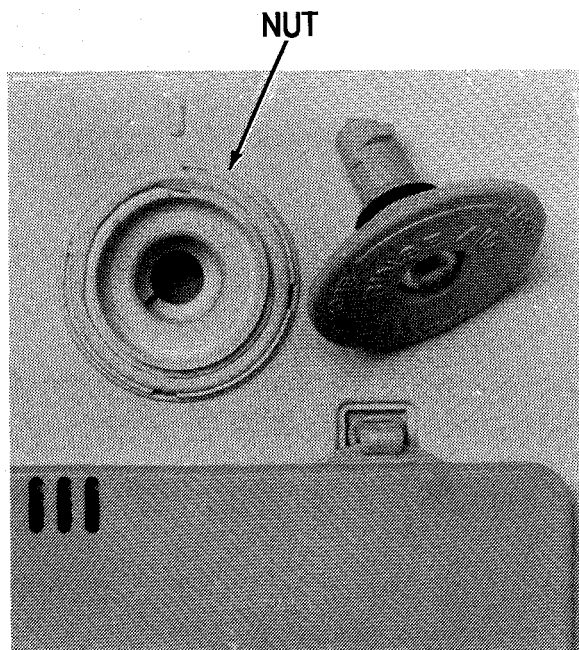

5. Separate inner door panel from complete door assembly.



Note: If you want to leave dispenser with inner panel, disconnect wire from detergent dispenser solenoids before pulling panel away from dishwasher.

DOOR SWITCH HOUSING AND BRACKET ASSEMBLY

Two door switches are used. These switch both lines of the 120V-60Hz electrical operation; Hot and Neutral.

To Remove

1. Open dishwasher door.
2. Remove the 6 screws securing the inner door to the outer door. Also remove one screw (right side of inner panel) hold switch and latch assembly in position. Unscrew rinse aid cap and set aside.



3. Separate the inner door panel from complete door assembly.
4. Remove plastic cover from control panel components.
5. Remove 1 screw (left side of switch bracket) securing the door switch handle and bracket assembly to control panel.

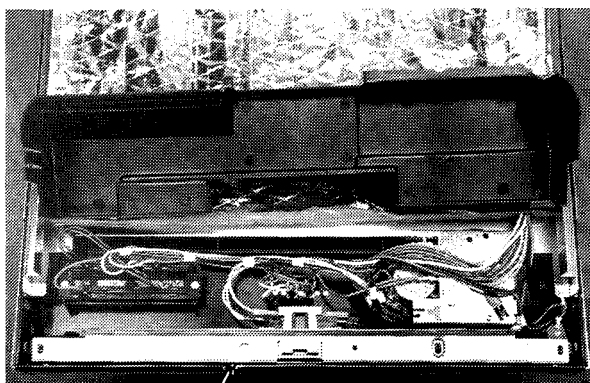

REMOVE

GENERAL

Door Switches require no field adjustment. If required, door switches may be pushed out of bracket housing and replaced.

Door Strike and Latch The door strike serves as a "TENSION" lever for proper door seal. It also provides the mechanical actuator for door switch operation.

To adjust door strike

Loosen hex screw securing strike assembly to tub. Slide strike "in" to increase tension on door and door seal. Moving strike "out" will decrease tension.

Note: Before moving strike, mark location of strike as it sits in tub flange. This will provide a guide to make accurate "in" or "out" adjustment.

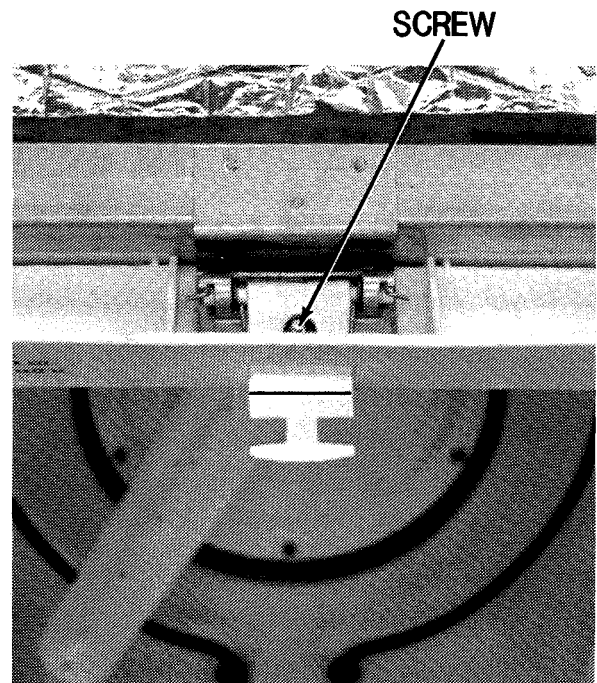

DOOR GASKET

The door gasket provides a seal between the door and tub.

To Remove A Door Gasket

1. Open door.
2. From lower corner, pull gasket up and out of tub recess. Note excess gasket in both left and right hand lower corners.

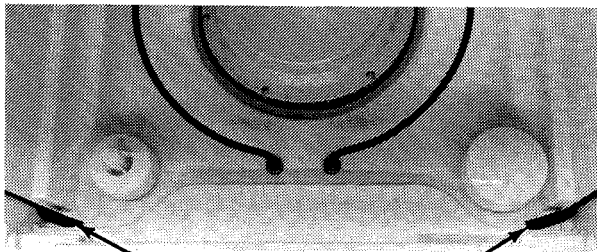

DOOR SEAL

To Replace Door Gasket

1. Locate center line of gasket by holding 2 cut ends together and grasping opposite center with thumb and forefinger.
2. Start at top center of tub recess. Insert gasket into recess in U shape configuration of tub.

Note: The two "ribbed" sides of gasket go back into recess first and will be positioned at right angles to sealing surface.

When properly installed, gasket will have excess length (approximately 1") folded over in each lower corner of tub. This permits seal between inner door panel and lower corner of tub.

CONTROL PANEL (CONSOLE)

The inner door panel must be removed to obtain access to screws securing control panel to door panel.

Access To Control Panel - Facia

1. Remove torx screws securing inner door panel to outer door panel and 1 screw holding door switch mechanism.

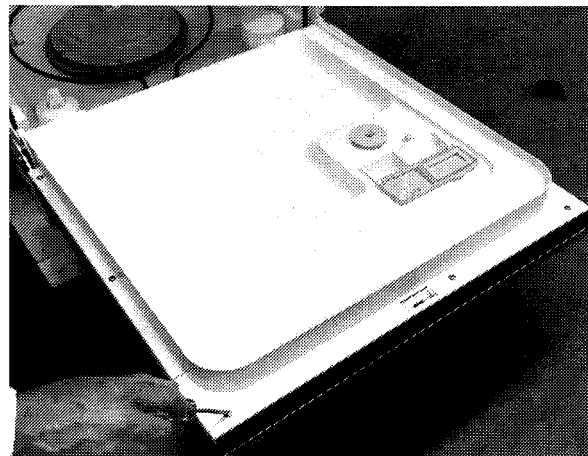

2. Remove plastic shield.
3. Remove hex screws (2) in each corner of door panel, securing control panel to outer door.

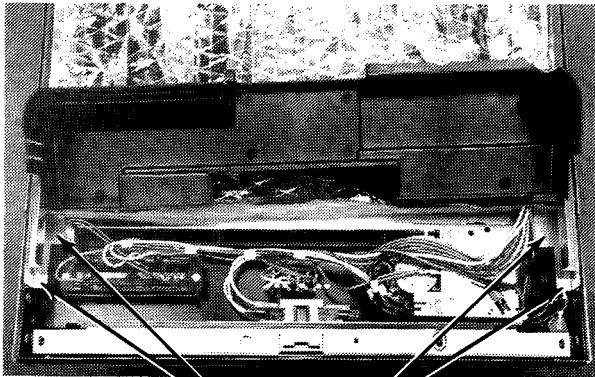

**REMOVE
HEX SCREWS**

4. Disconnect wiring to electrical components in the control panel area.
5. Remove electrical components

Note: Pull timer knob off from front.

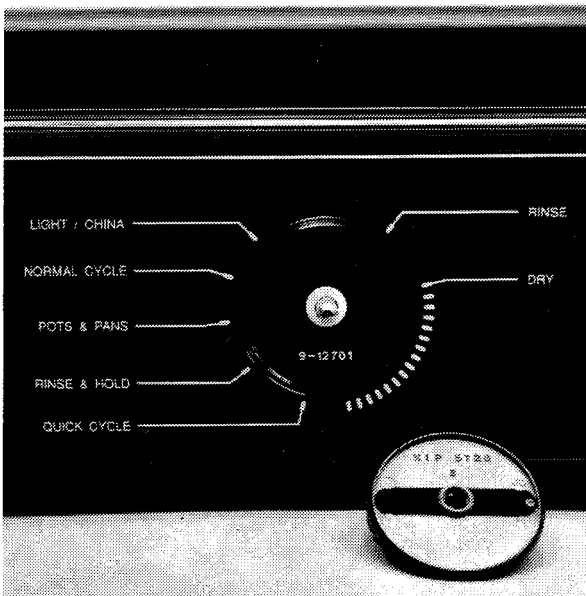

6. Bend up 8 retainer tabs which hold the control panel facia to the control panel itself. Note position of ground wire attached to tab.

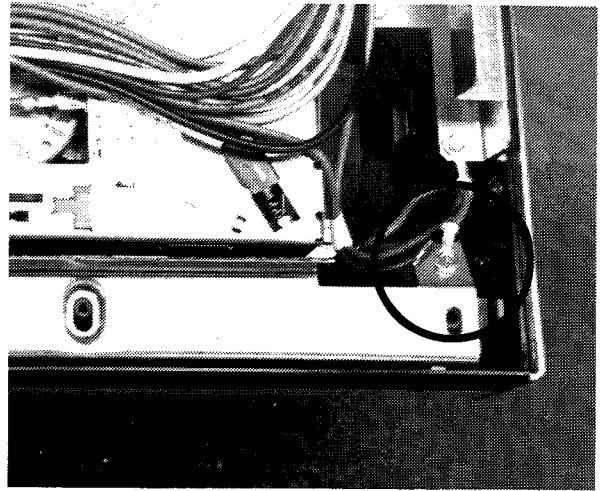

7. Carefully separate facia from panel by prying the tabs loose. **THIS PANEL CAN BE BENT OR SCRATCHED IF CAUTION IS NOT USED IN DISASSEMBLY.**
8. As facia separates, 2 mounting pegs secure the "heater and delay lamps" to facia. These will fall out. Note position of these pegs to the lamp body when separating the facia for reassembly purposes. Push the lamp bodies down to disengage pins from panel.

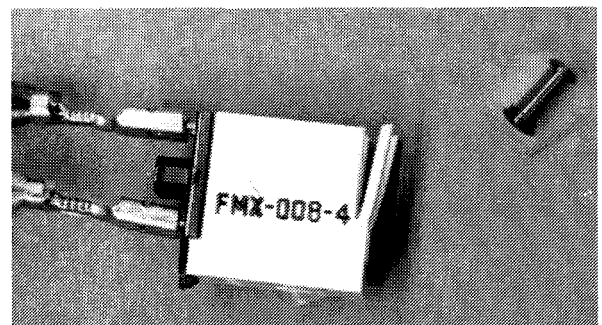

TRANSFORMER - MICROPROCESSOR MODELS

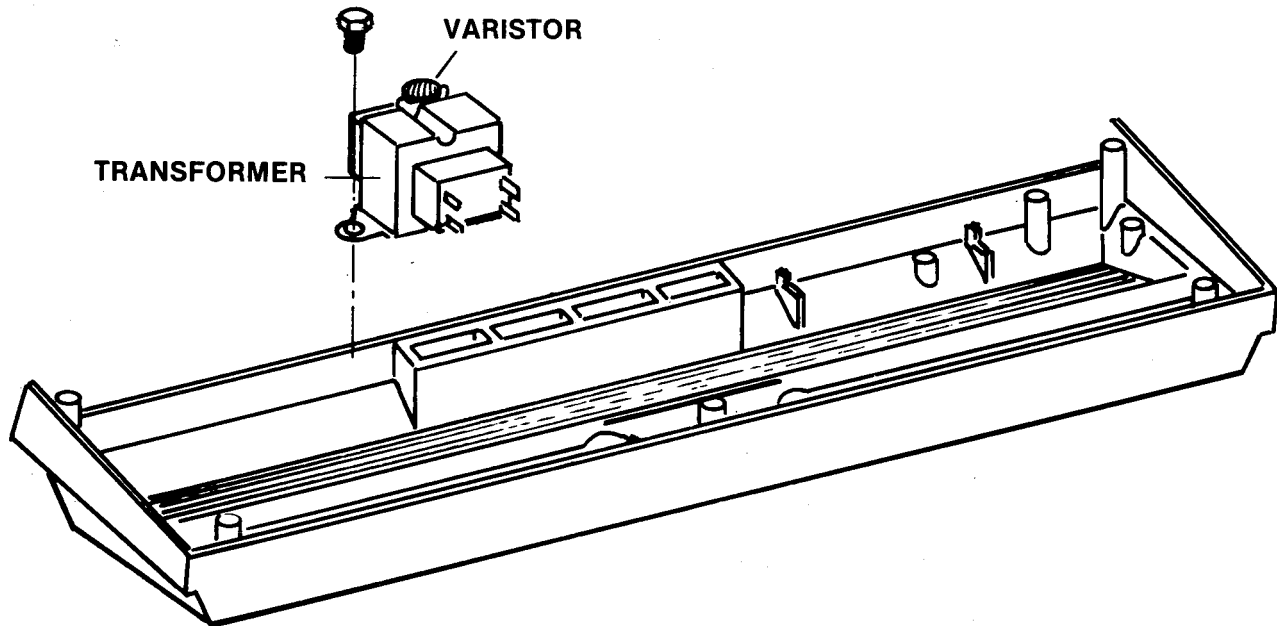

The transformer is used to provide the proper operating voltages to the microprocessor board. The transformer is mounted to the control panel. Removal of the control panel is therefore necessary in order to service the transformer.

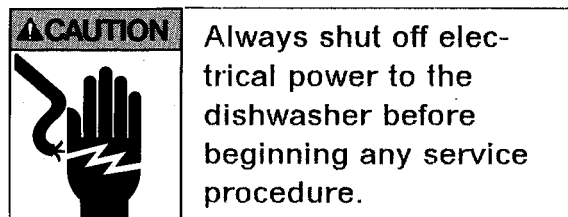

To Remove Transformer

1. Remove wires.
2. Remove 2 screws securing transformer to control panel.

To Check Transformer

Because of the low resistance readings found on both the primary and secondary coils of the transformer, a continuity check across the transformer coils with an ohmmeter is recommended. A closed circuit (continuity) should be seen. If an open circuit (no continuity) is noted, the transformer should be replaced. Should you have questions on an ohmmeter or performing continuity checks, refer to the Electrical Test Equipment section.

CAUTION



Live voltage checks on the transformer are not recommended due to the potential of electrical shock.

VARISTOR - MICROPROCESSOR MODELS

The varistor is designed to protect the microprocessor board from excess voltage. At normal line voltage, the varistor shows extremely high resistance. When the line voltage exceeds the threshold of the varistor, its resistance decreases to a point of providing a voltage “bleed-off” path. This will prevent line voltage surges or “spikes” from reaching the microprocessor board.

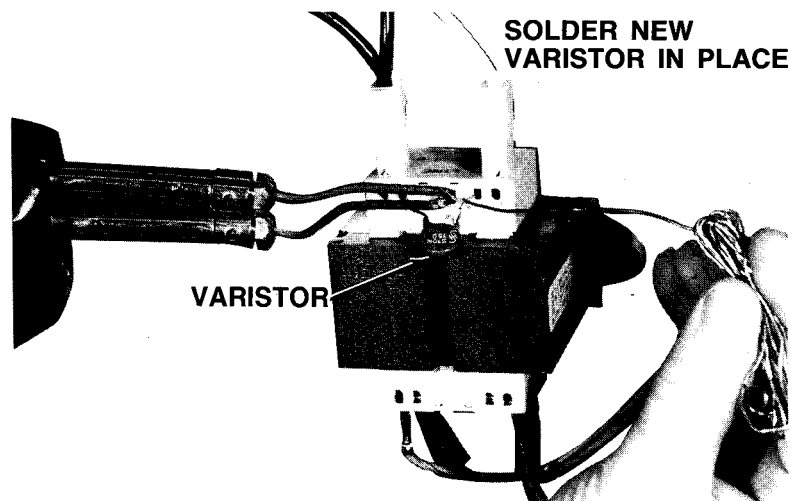

The varistor is actually a part of the transformer. Because of this, if visual inspection shows damage to the varistor, the transformer and microprocessor board should be checked. If no damage to the transformer or microprocessor board is detected, the varistor may be cut out and a replacement varistor soldered in place.

CONTROL SWITCH

For removal, take out 2 cross head screws at the right and left ends of this switch. Disconnect wire leads. Refer to electrical schematic for electrical testing.

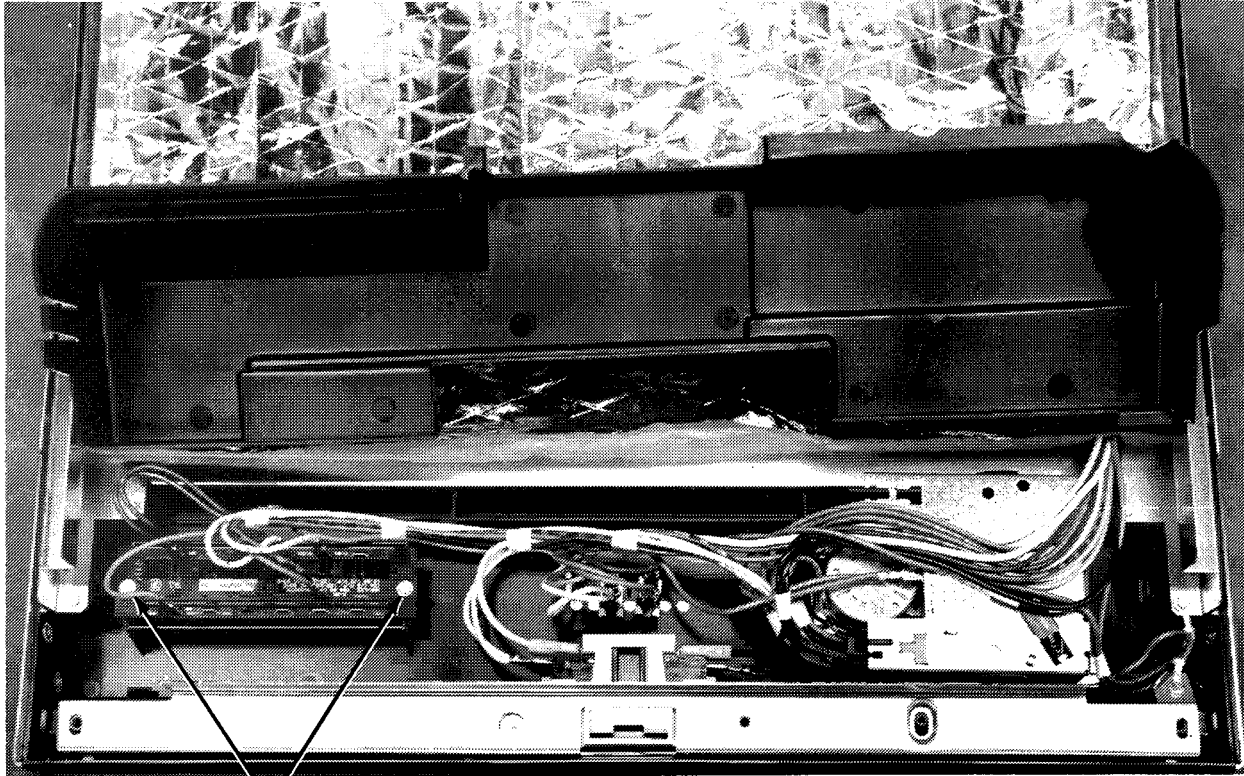

REMOVE
SCREWS

TIMER

The timer circuits are illustrated in electrical schematics included in this manual. Refer to schematic for Electrical Testing Procedures before attempting to replace timer. *Timer must be replaced as a complete assembly.*

To Replace

1. Remove knob.
2. Remove 3 cross hex screws holding timer to control panel (console).
3. Remove electrical multiple harness connector which plugs into timer contact assembly.

Note: Squeeze locks on each side of connector and tilt side to side while pulling to disengage. For reassembly, note rotation of plug. The "key" end of the connector is always against inner door panel when installed correctly.

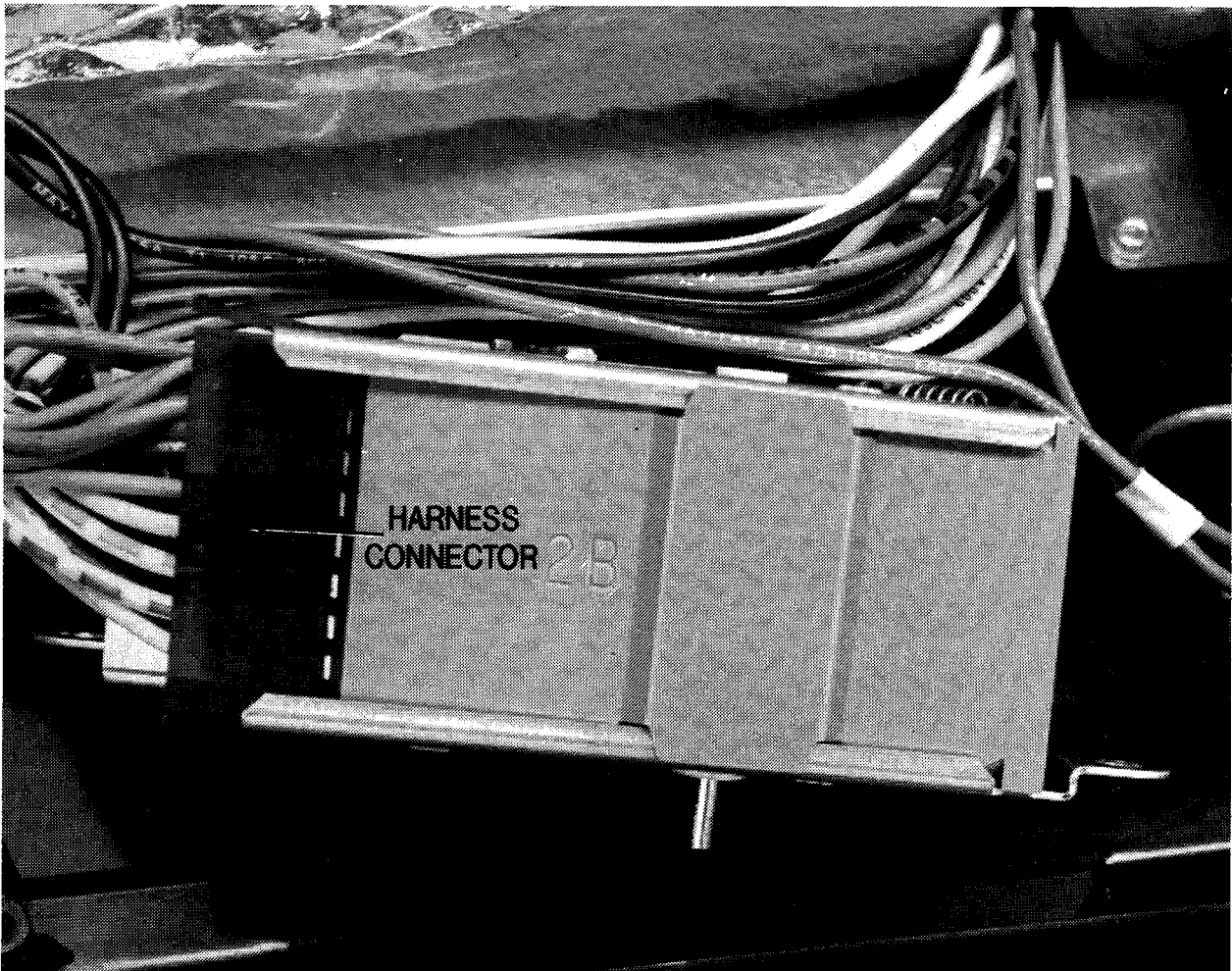

DOOR HINGES - SPRINGS

The door hinge screws are used to adjust complete door assembly to dishwasher tub front. Slots in the outer door panel allow for loosening hinge screws and moving door panel up or down as required.

To Remove

1. Disconnect door springs.
2. Remove outer door trim strips.

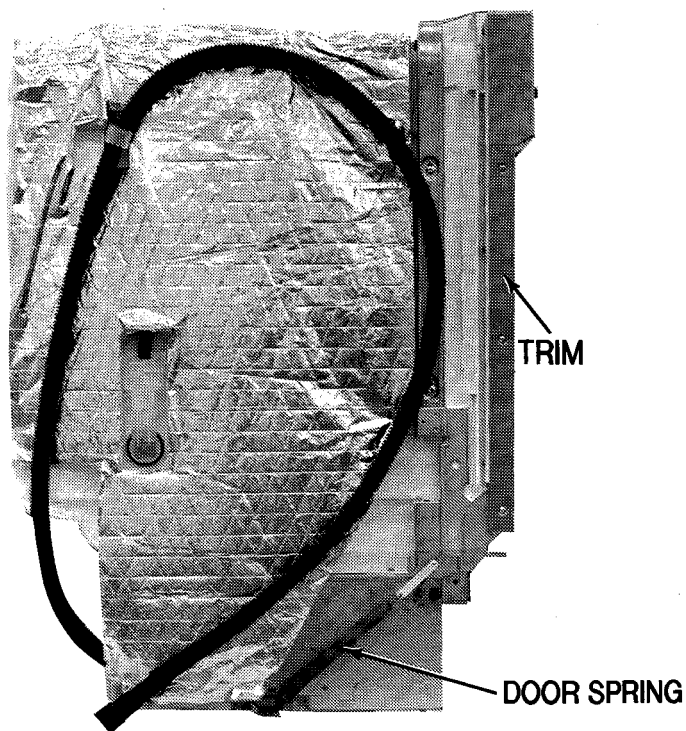

3. Remove 3 torx head screws on each side of door frame.

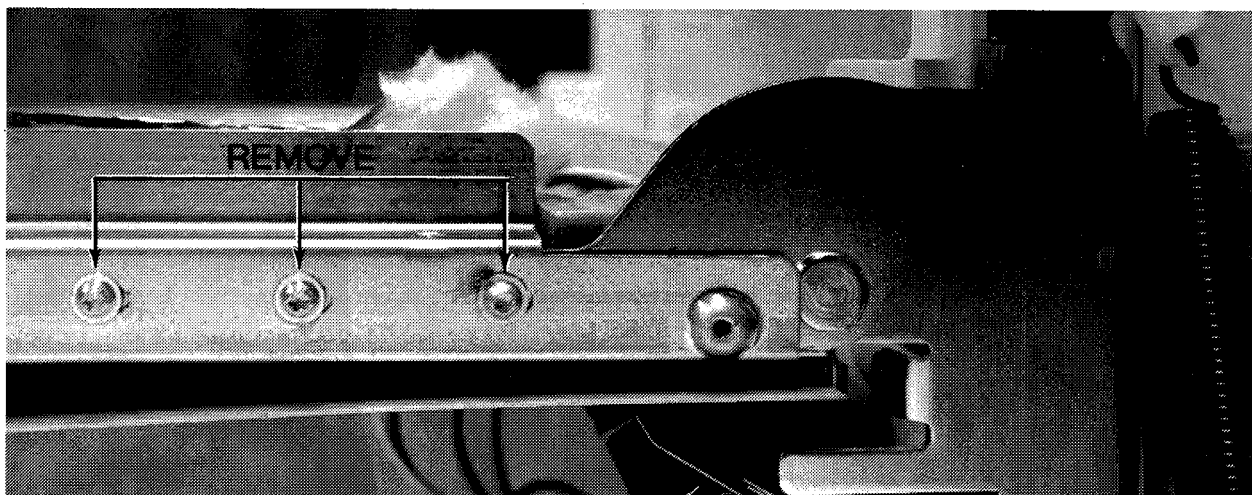

4. Pull hinge and bracket with studs out of weld bracket.

HINGE SPRINGS

Tension for door closing and opening is adjusted by locating the upper spring anchor to top or bottom notches. Normal spring location is one spring in each notch. If a heavy decorator door panel is used, it may be necessary to relocate both door springs to the "top" hinge bracket position.

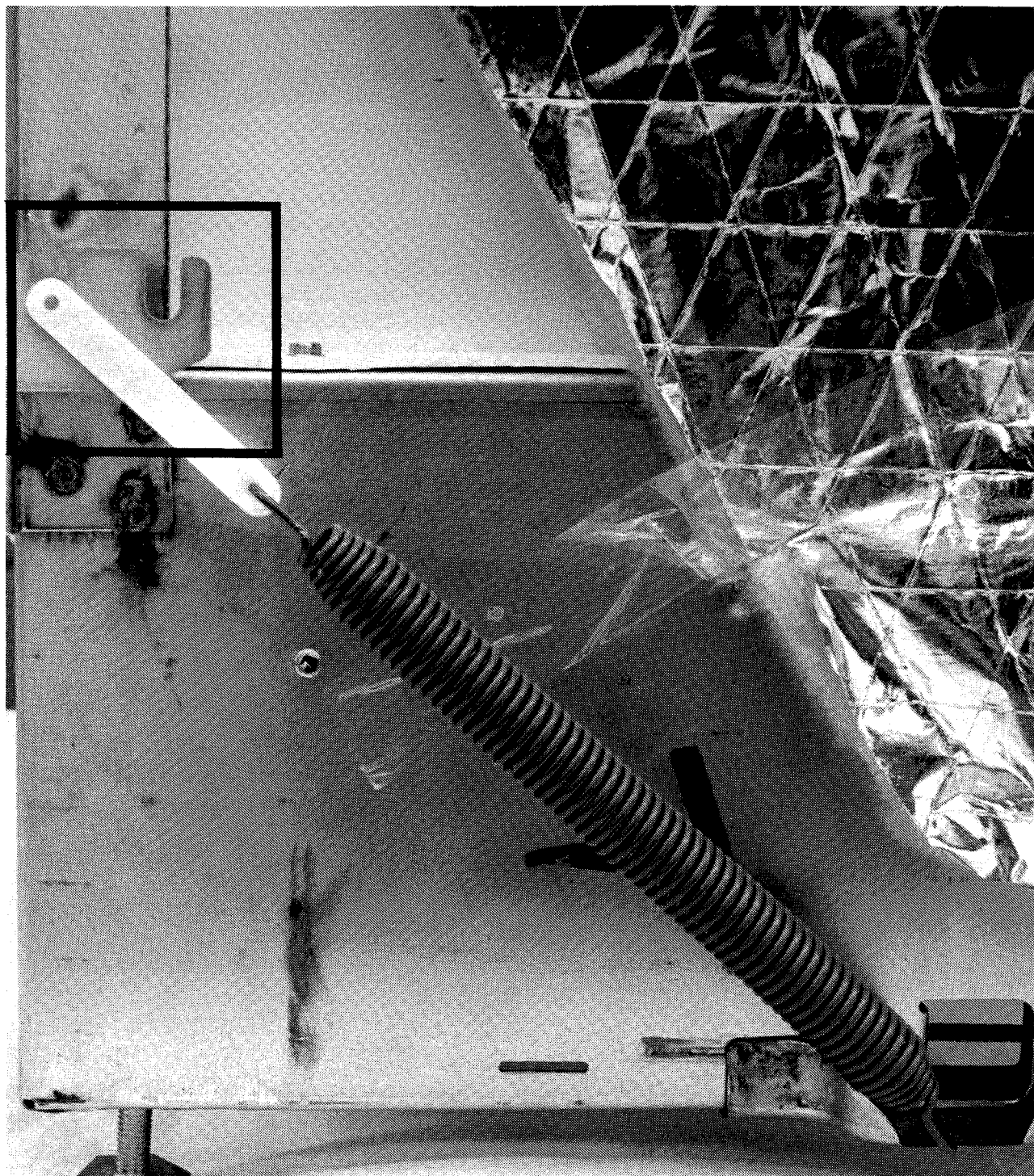

DOOR SPRING ADJUSTMENT

To change door spring tension, use the 1/4" hex-nut driver to either loosen or tighten a single screw located on each door spring adjustment bracket. The spring adjustment brackets are located on either side of the dishwasher frame. These brackets stretch the springs by sliding forward and back along the dishwasher frame.

To increase spring tension: tighten each of the screws by turning clockwise.

To decrease spring tension: loosen each of the screws by turning counter-clockwise.

The springs should be adjusted approximately the same so they have an equal amount of tension.

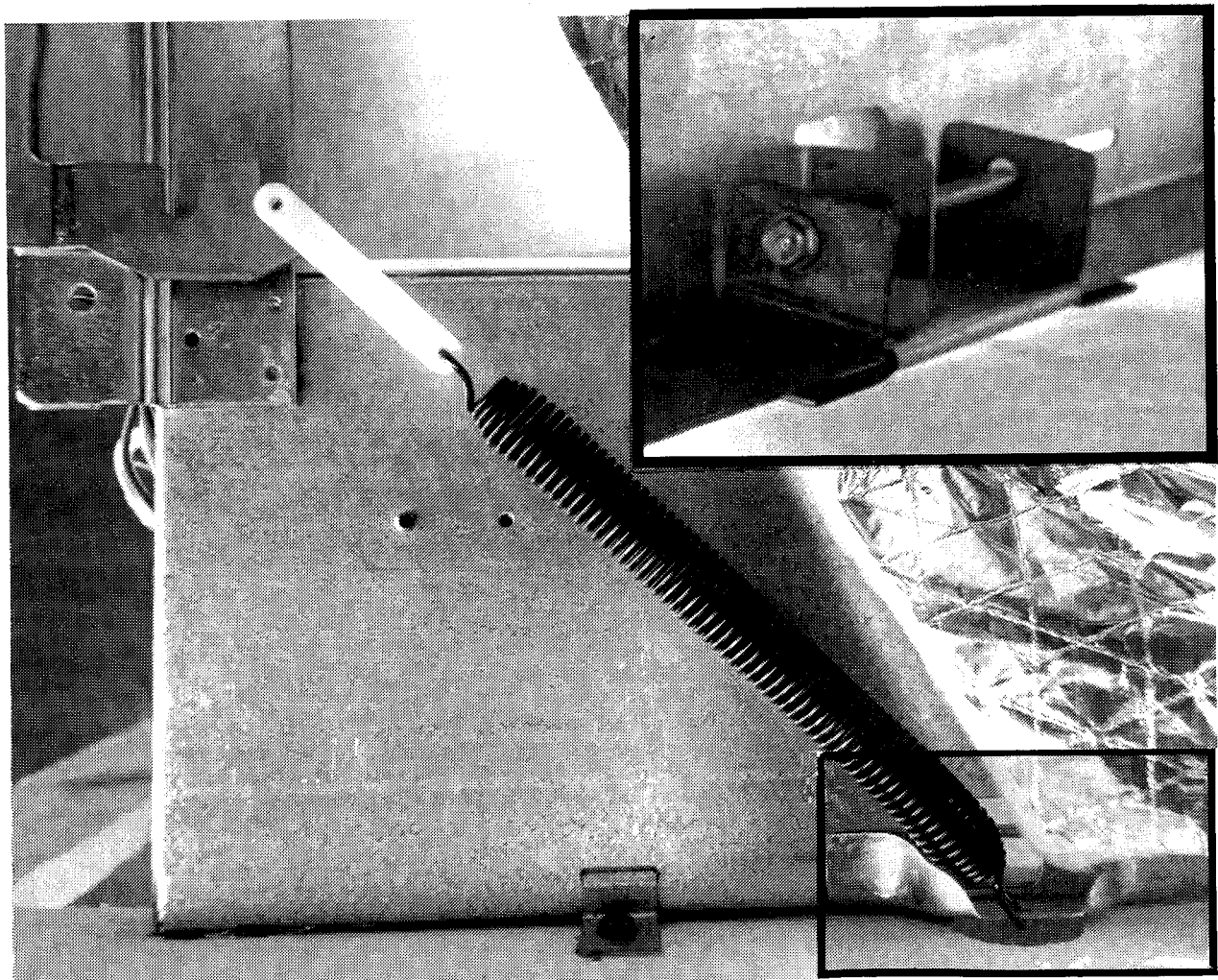

UPPER WASH ARM

To Remove Upper Wash Arm

Unscrew nut between upper wash arm and tub with finger tips and remove (nut, upper wash arm and snap shower retainer). If not able to budge nut, use of a dull tool may be used to loosen nut. Be careful not to damage dishwasher tub.

With finger tips, squeeze or push tabs inside of nut towards the center and pull nut off.

Squeeze tabs again to remove retainer from wash arm.

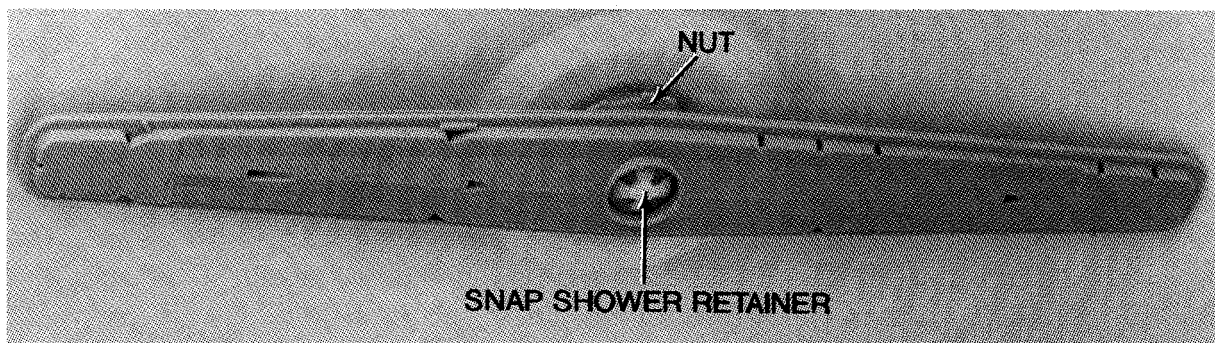

When replacing, push arm and nut up into outlet until it snaps in place.

UPPER WASH ARM HOSE

Water is supplied to the upper wash arm by the module assembly, through the upper wash arm hose. This hose runs up the right side of the tub and enters the top center. It is secured to the tub using a sealing washer and a special outlet assembly. A large plastic nut accessible from inside the tub, holds outlet in place.

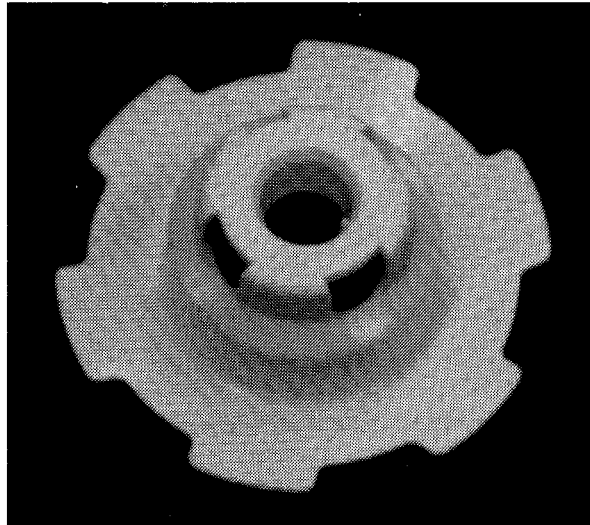

Note: A short section of rubber hose is used to couple the upper wash arm hose to the module assembly.

Removal of the upper wash arm hose will require removing undercounter (WU) models from their installation. Since this will involve disconnecting the electrical, water and plumbing services, a qualified service technician or individual should be contacted. In the case of convertible (WC) models, it will be necessary to remove the cabinet and wood top. Refer to Cabinet, Wood Top And Base Frame, as needed.

To Remove Upper Wash Arm Hose

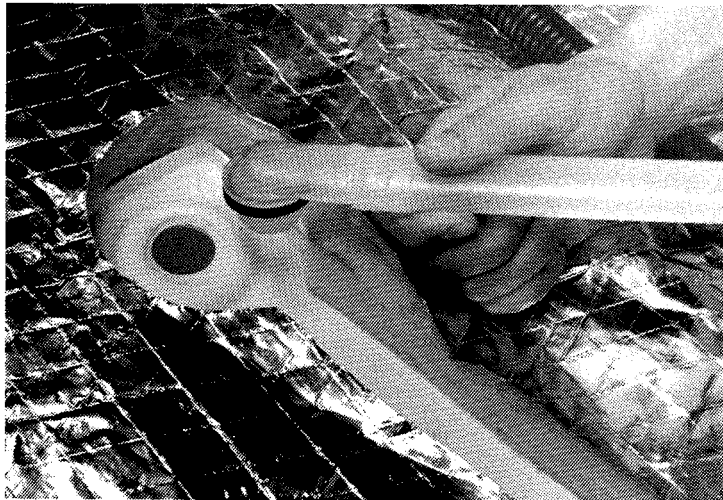

Remove four screws holding access and toe panels. Refer to Front Panel, Access Panel And Toe Panel, as needed.

1. Loosen hose clamp securing upper wash arm hose to module and remove hose.
2. Remove upper wash arm.
3. Unscrew outlet nut for upper wash arm and remove upper wash arm hose.

Note: When reinstalling outlet assembly, be sure the seal washer is properly positioned on the upper wash arm hose.

POWER MODULE

The power module consists of a “pump” and electric “motor” combined to provide drain and recirculating functions for the dishwasher cycles. If a failure is suspected inside the pump assembly, individual parts in the pump may be replaced. However, if the housing or an electrical failure of the motor needs attention, the **COMPLETE PUMP AND MOTOR (MODULE)** must be replaced.

To repair the pump portion of the power module, it is not necessary to remove it from the dishwasher.

To Replace The Power Module

Unscrew center wash tower from inside dishwasher and remove lower spray arm.

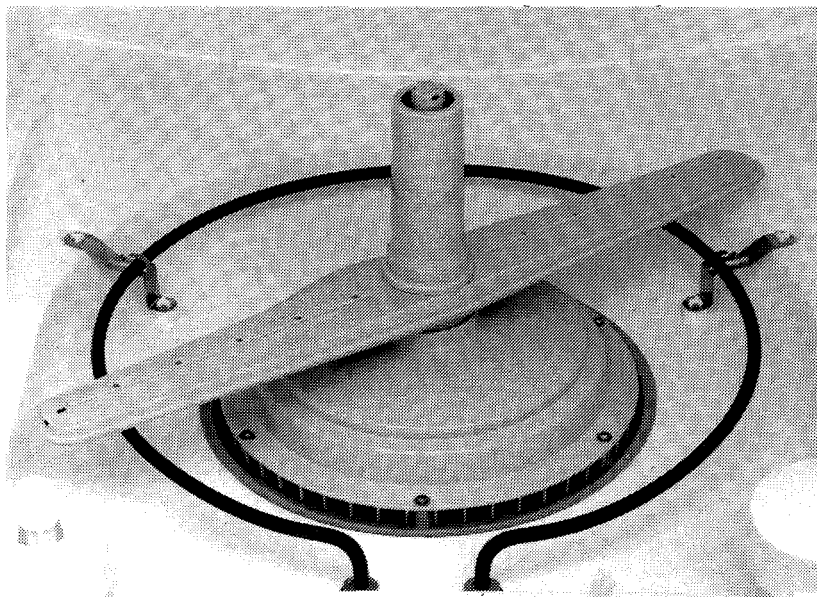

1. Remove lower access panel.
2. Loosen drain hose clamp (left side of module) and disconnect drain hose from pump housing.
3. Loosen recirculating hose clamp (right side of pump housing) and remove recirculating hose.

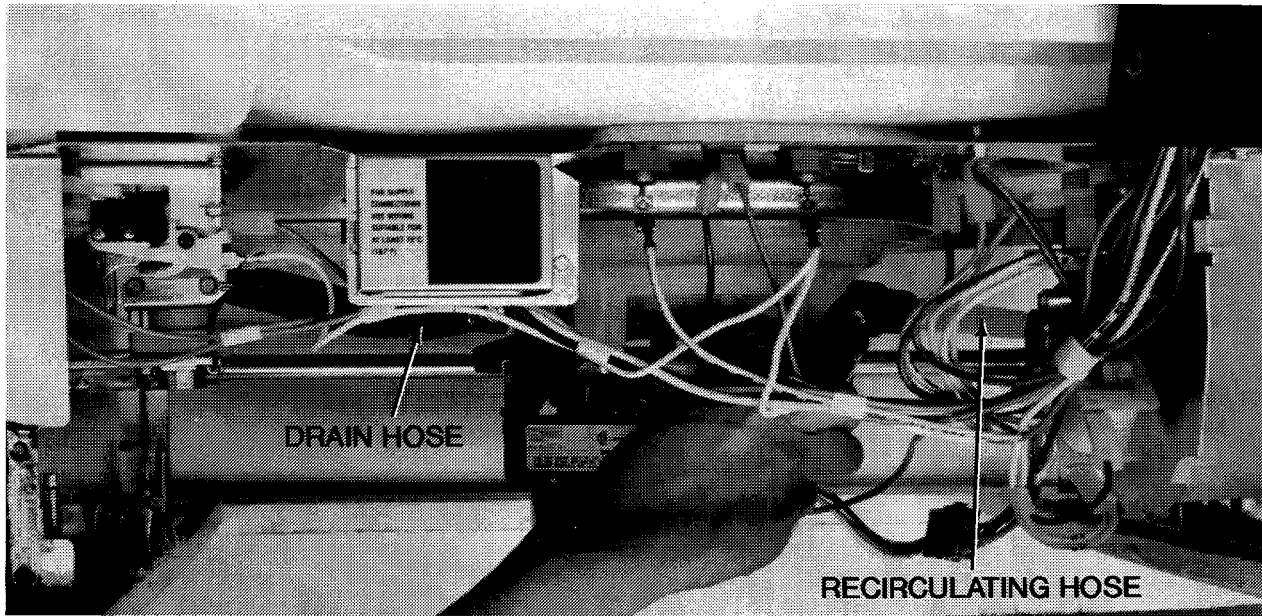

4. Disconnect wire harness connector from drive motor. Note: This can be reconnected 180° wrong. Observe proper connection before removal.

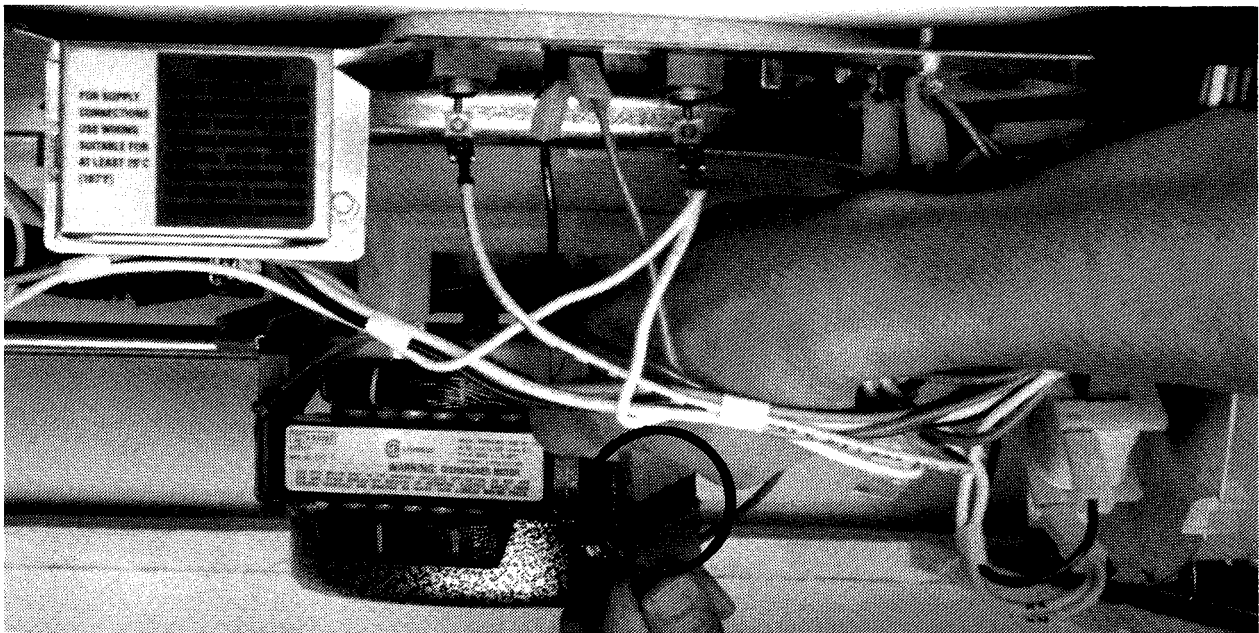

5. Remove hex screw holding motor ground wire to motor frame.

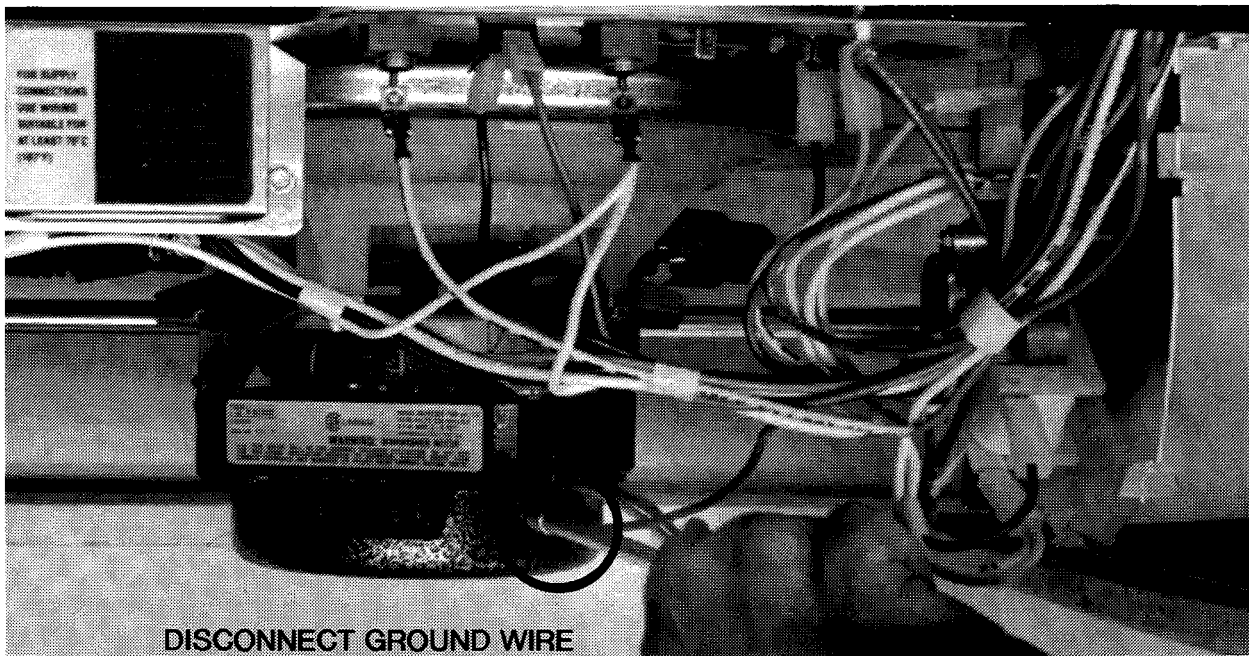

6. Push clamping ring handle (on left side of power module) toward the rear of the dishwasher to disengage module from tub. Align notches in module and clamping ring to pull assembly up and out of the dishwasher.

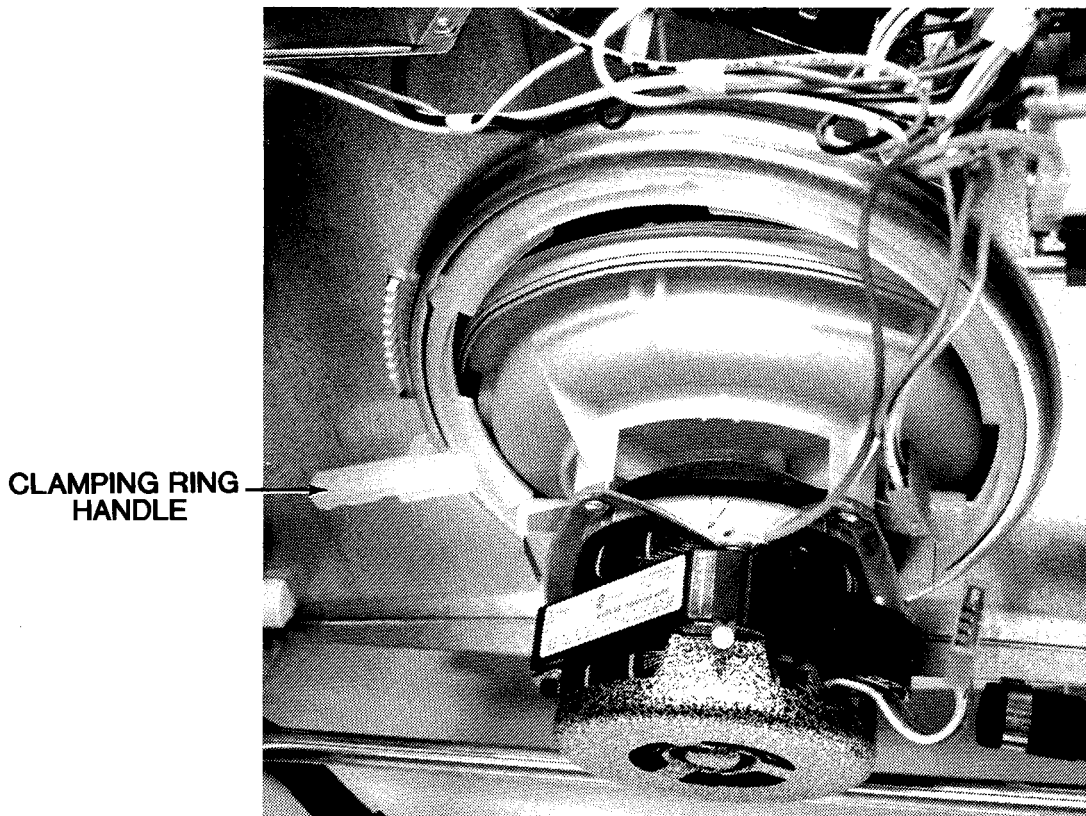

7. Note position of pump housing gasket for reassembly. Also, note alignment mark for reassembly.

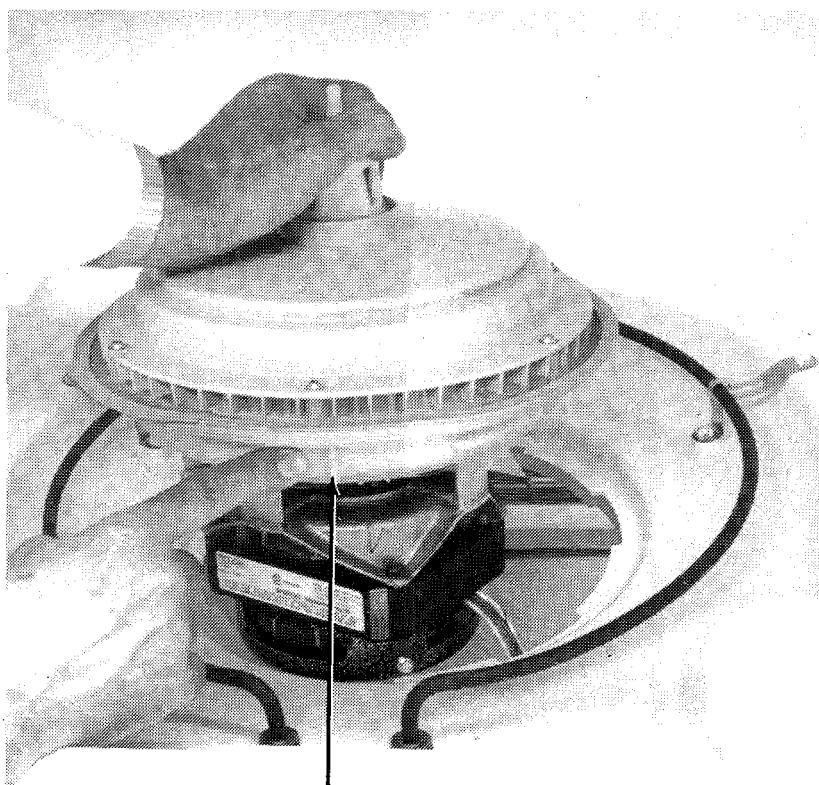

ALIGNMENT MARK

Power Module Disassembly

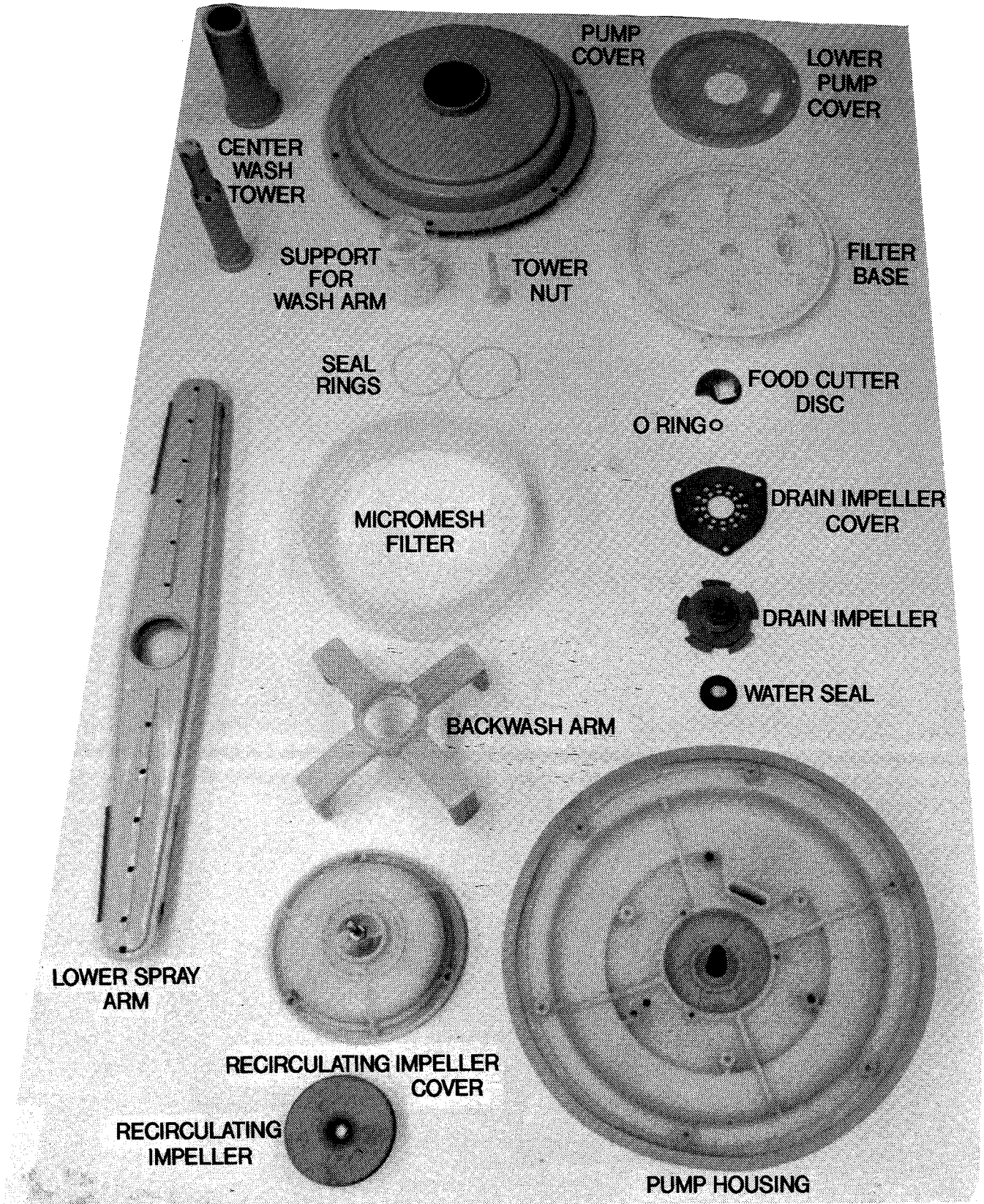

1. Unscrew center wash tower to remove lower wash arm assembly.

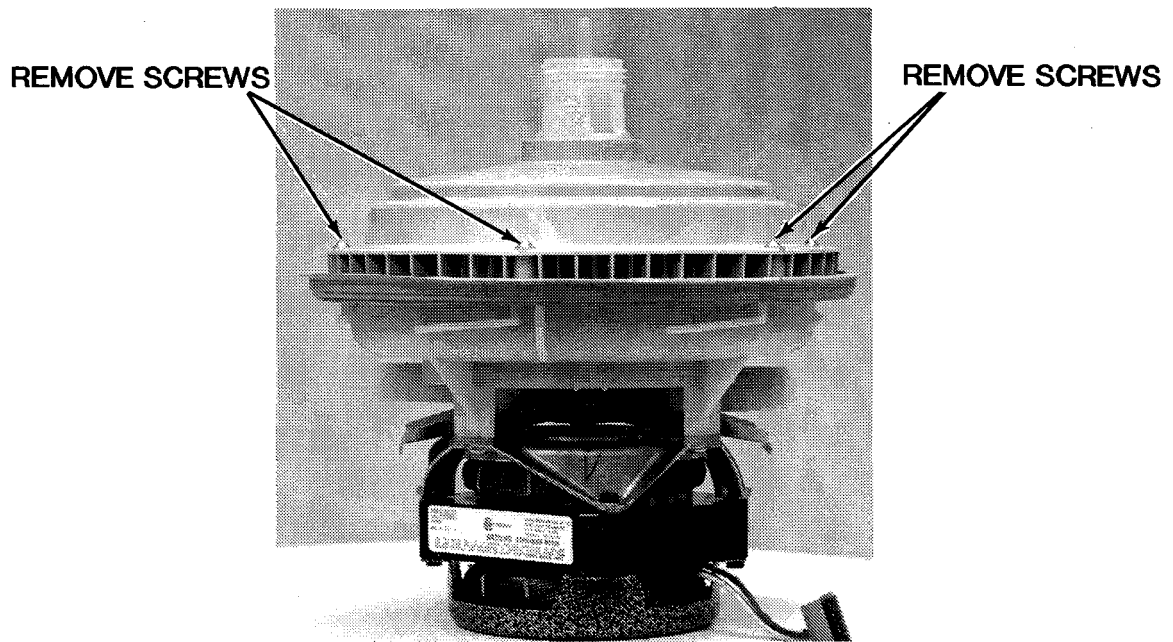

2. Remove 6 screws securing pump (strainer) cover to pump housing.
Note: 2 seals are in strainer hole. Pull cover off.
3. Pull off backwash arm.

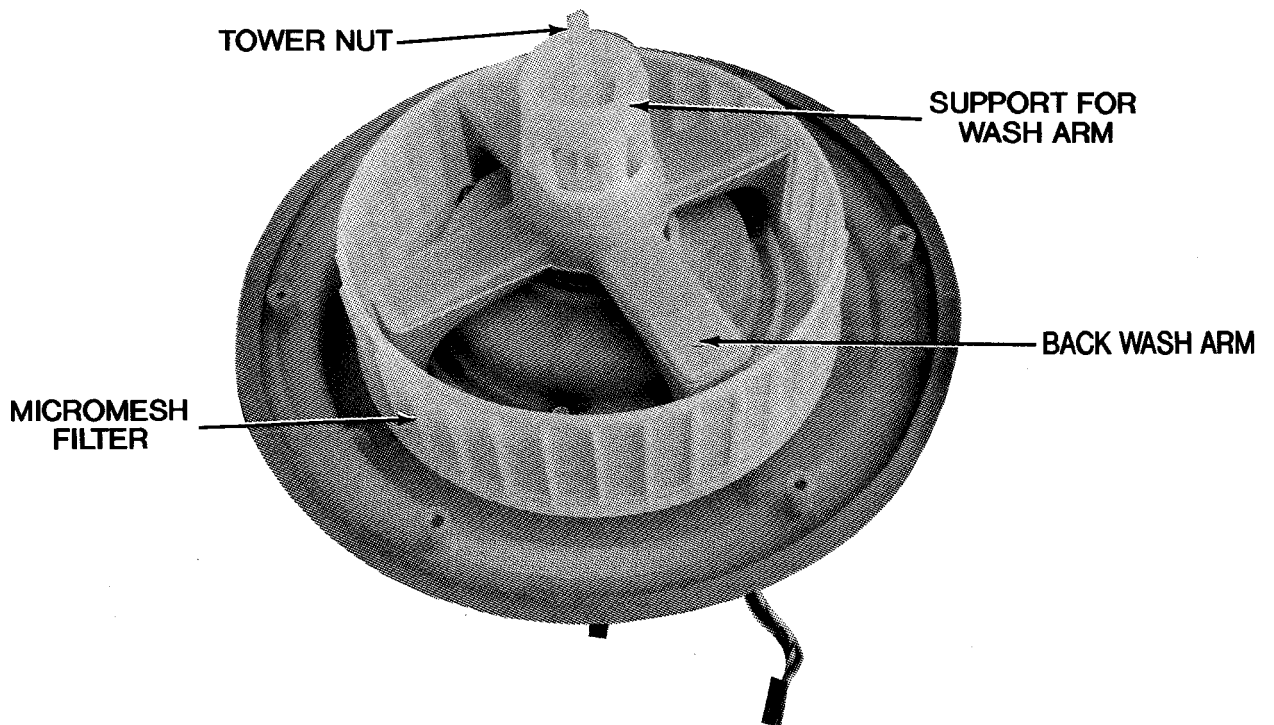

4. Unscrew tower nut from support for wash arm. Raise support off shaft.
5. Pull out micromesh filter.
6. Remove 3 screws holding recirculating impeller cover in position. Pull cover off.

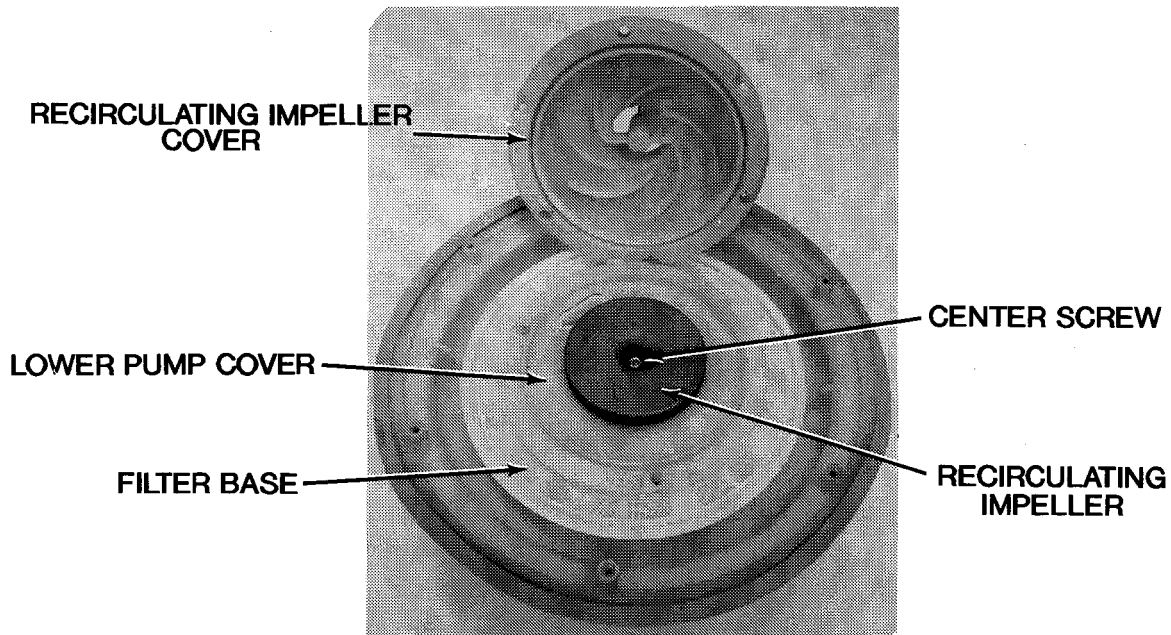

7. Remove center screw holding recirculating impeller to motor shaft.
8. Lift off impeller, lower pump cover and filter base.

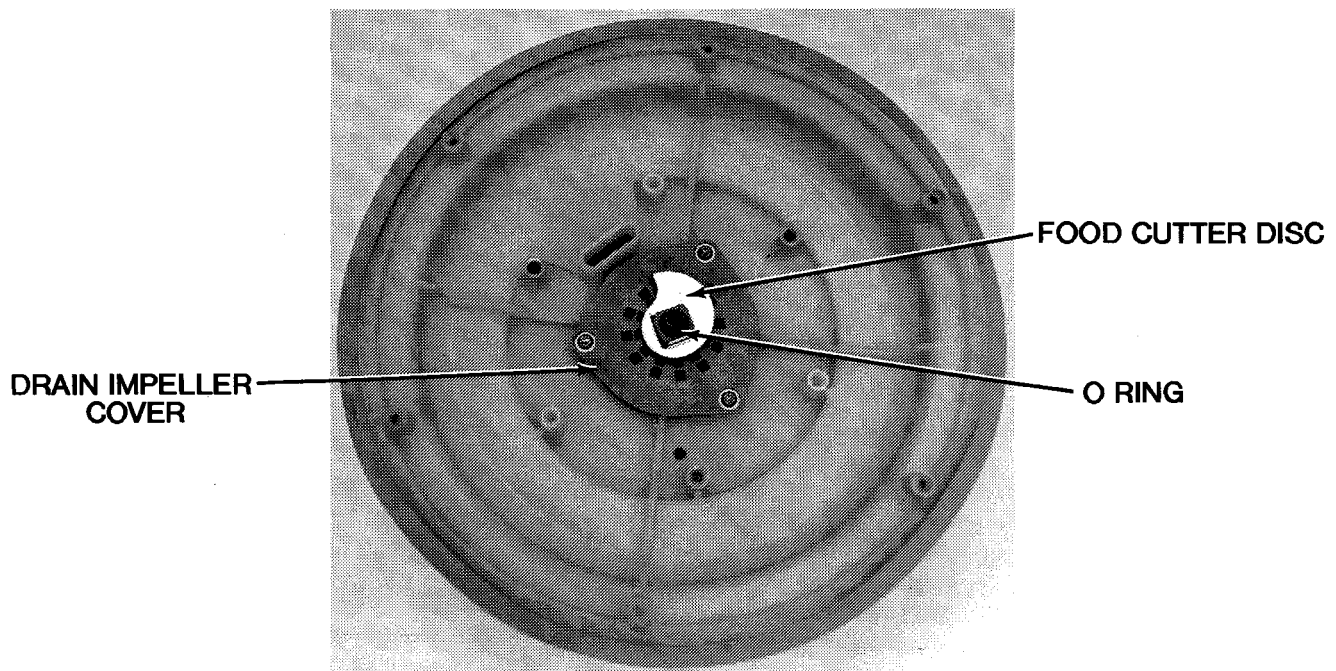

9. Pull off food cutter disc.
10. Carefully remove "O" ring from motor shaft.
11. Remove 3 screws from drain impeller cover.

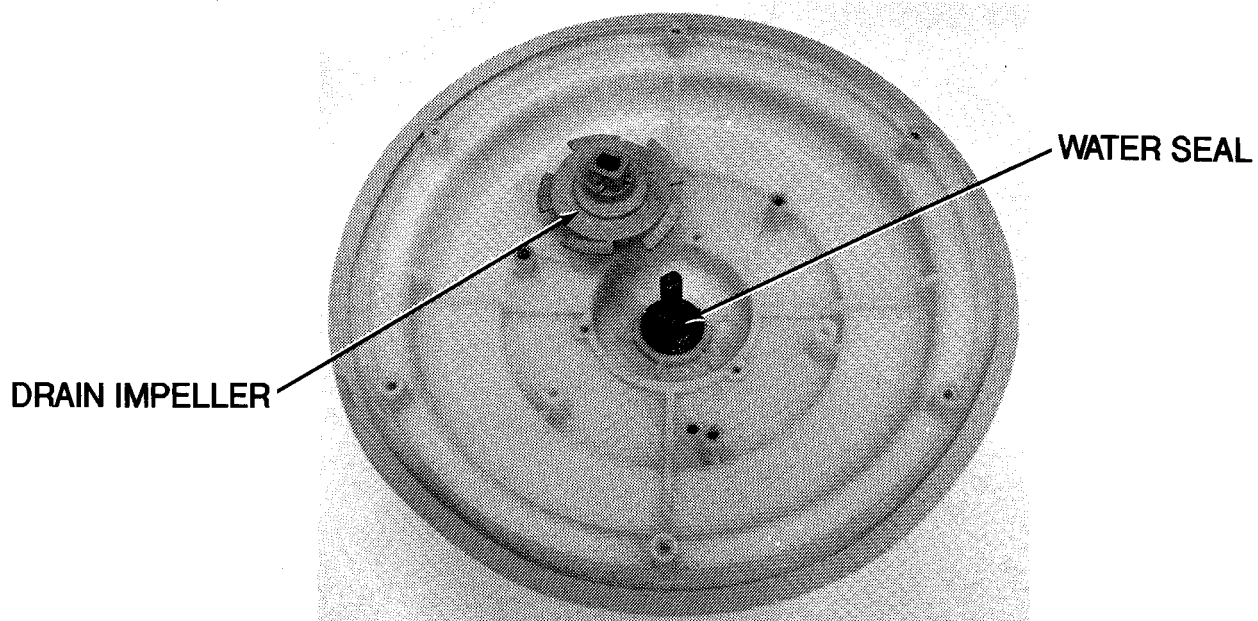

12. Lift cover off.
13. Pull out drain impeller.
14. Carefully pull out the water seal.

This is the extent of teardown recommended. Replace complete power module assembly if pump housing must be repaired or replaced.

JUNCTION BOX COVER

This cover has a tab on the left side and is secured to the mounting bracket with one screw. Remove this screw for access to wiring for electrical connection to house electrical supply.

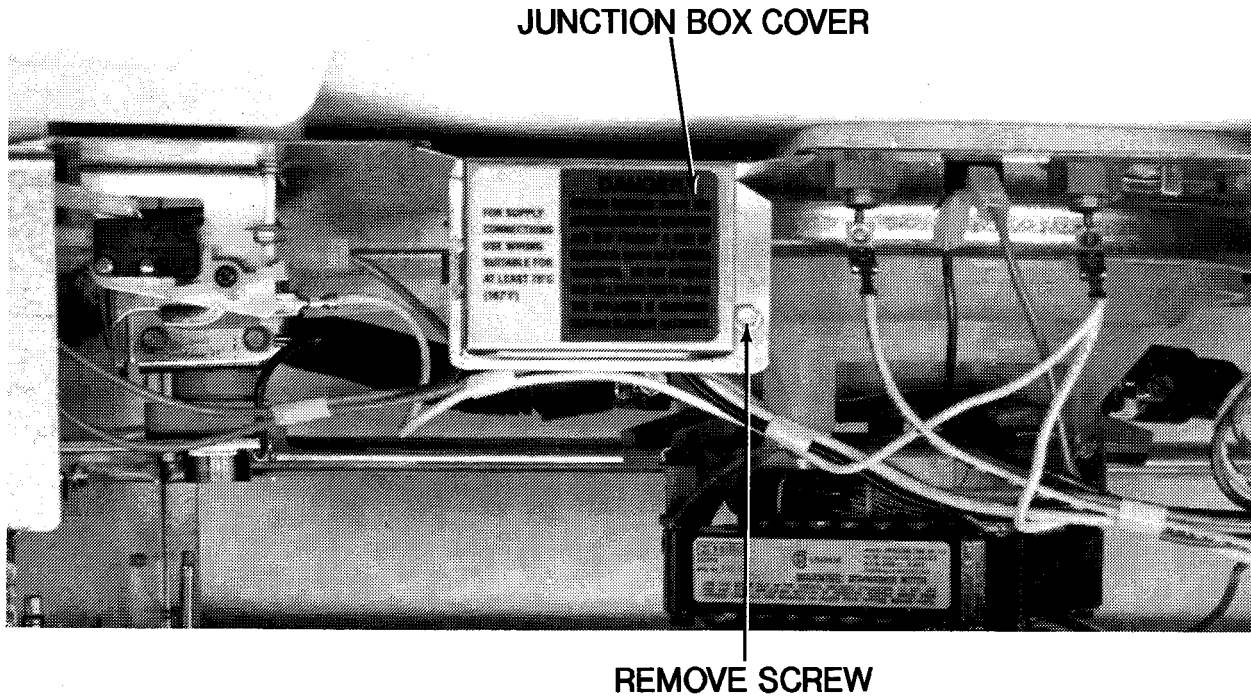

THERMOSTATS

Removal And Replacement

Thermostats are pushed into position and secured by a spring strap or tab across the center.

1. Remove the two wires attached to thermostat terminals. Note location of wire positions on each thermostat is not important.
2. Pull down on spring tab to release thermostat. Pull out and down to free from bracket.
3. When reassembling, note notch in thermostat body for matching with spring tab. Push up and into position.

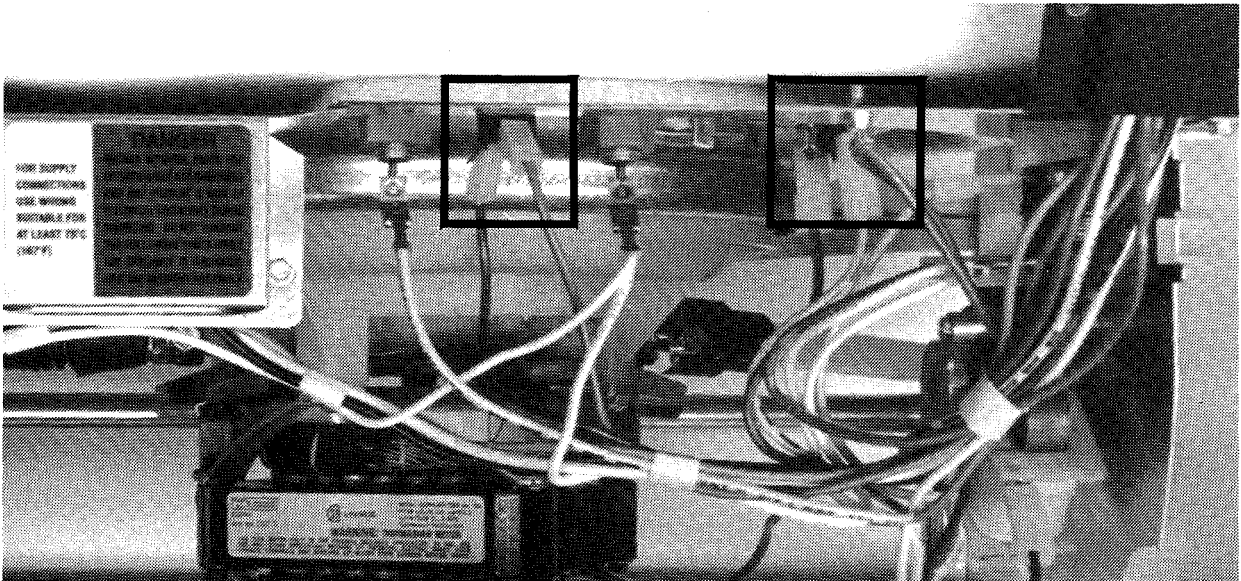

WATER VALVE

All models covered in this service manual use a metered fill system. The metered fill will supply approximately 2 gallons of water to the dishwasher on each fill.

As a back up to the metered fill system, the timer (or microprocessor) will automatically drop the electrical circuit to the water valve after approximately 100 seconds. This will prevent an overflow of the dishwasher should the float assembly or float switch fail.

The valve is designed to provide satisfactory operation at water pressures from 18 to 120 P.S.I. Low water pressure will effect the water valve's ability to fill the dishwasher within the required length of time. The recommended water temperature is 140 to 150° F as it enters the dishwasher; for good washing results.

The water valve is operated on 120V-60Hz service for all timer models. Microprocessor models operate on 24VDC.

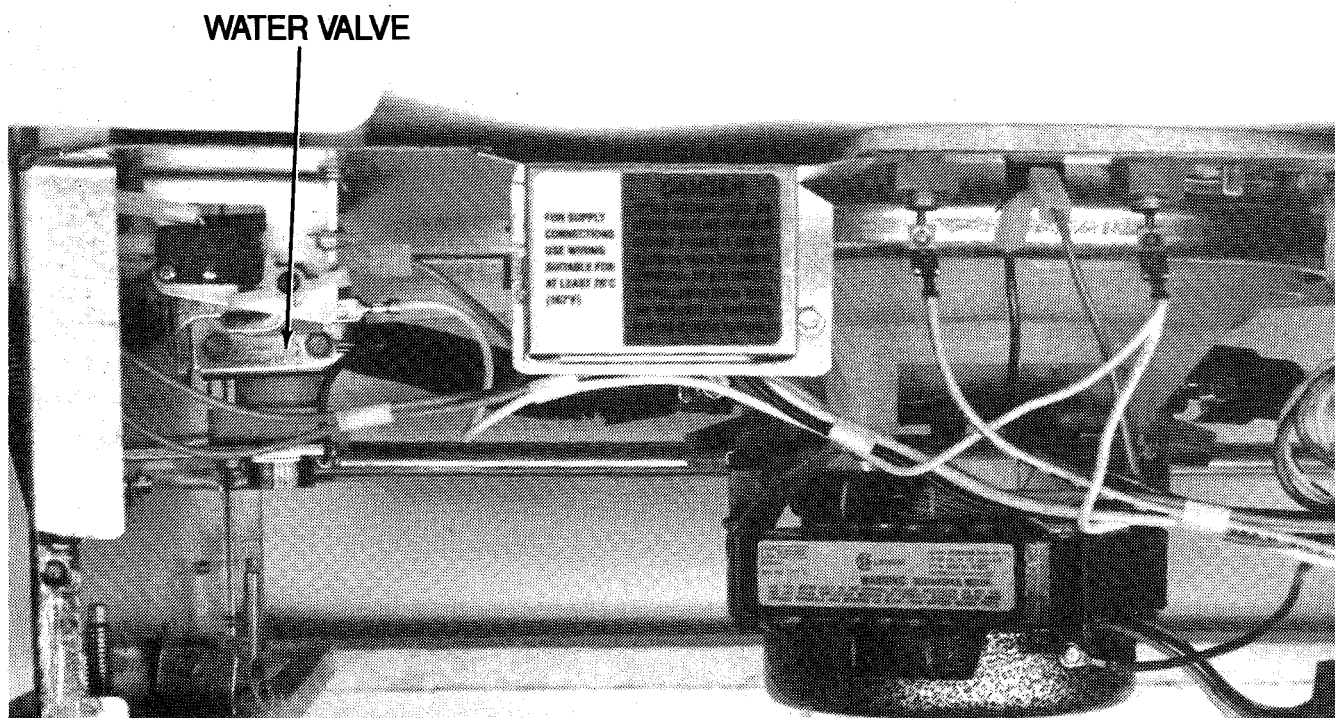

CAUTION Always shut off electrical power to dishwasher before beginning any service procedures to the water valve.

The water valve is mounted to the left side support of the dishwasher tub. Inlet water supply to the water valve comes in at the bottom of the valve. Turn off water supply to dishwasher.

To Remove

1. Be sure water supply is off. Remove access and toe panels.
2. Disconnect incoming water line connection.
3. Disconnect outgoing water injector connection.
4. Remove wires to water valve coils.

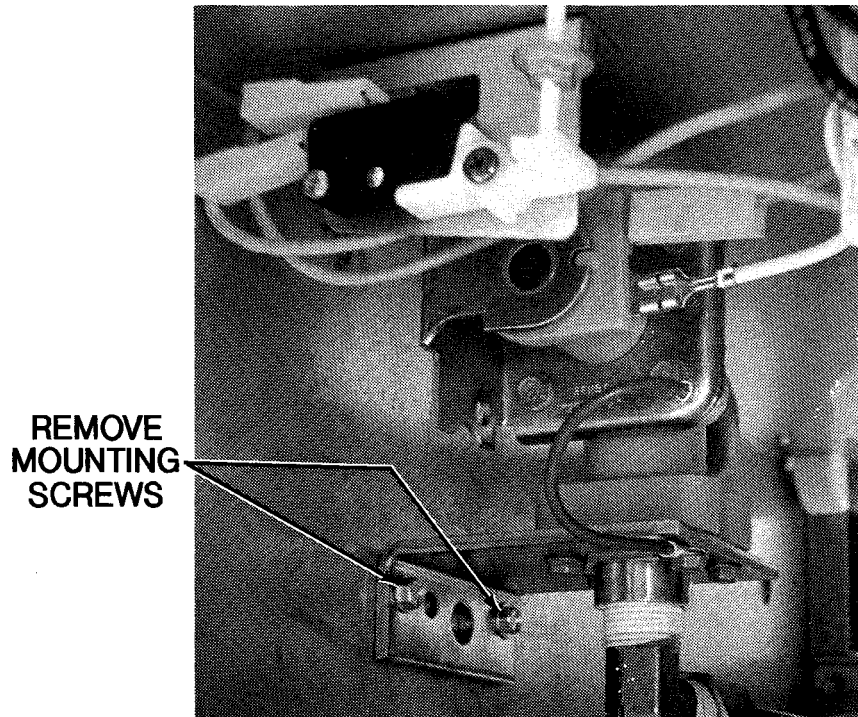

5. Remove 2 screws holding water valve to side support.

Note: Attempted repair or replacement of component parts of the water valve (other than cleaning or replacing inlet screens) is not recommended.

To Clean Or Replace Filter Screen

Sediment on the inlet screen can prevent the dishwasher from filling within the required time length.

Inlet screen can be cleaned by disconnecting the water valve from the water supply and removing the two screws holding the water valve mounting plate to the tub support.

1. Remove the four screws holding the mounting plate to the valve body. This will provide complete access to the screen. Clean or replace the screen.
2. When reassembling the water valve, make sure the ground wire is reattached to the water valve mounting bracket.

To Check Water Valve

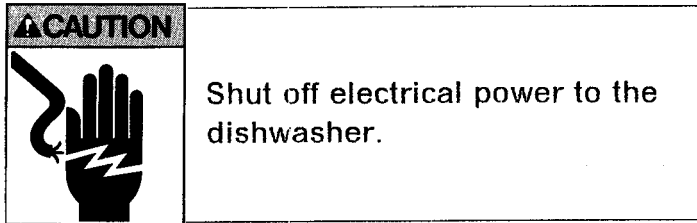

We recommend a continuity check be performed across the terminals of the water valve solenoid using an ohmmeter. A closed circuit (continuity) should be seen. If an open circuit (no continuity) is noted the water valve should be replaced.

A resistance measurement across the solenoid terminals can also be performed. The following should be seen:

WATER VALVE SOLENOID

120 volts AC	24 volts DC
900 ohms	140-160 ohms

Note: Use of a motor test cord hooked directly to the water valve will provide a quick means of determining water valve solenoid operation.

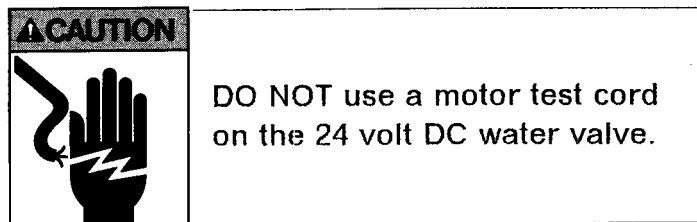

If unfamiliar with use of an ohmmeter or motor test cord or performing previous checks, refer to the Electrical Test Equipment section.

Diode - 24 Volt DC Water Valve (Microprocessor Models)

There is a diode installed across the solenoid of the 24 volt DC water valve. While the diode is actually part of the wire harness, it can be cut out if necessary and a replacement diode soldered in place. When replacing the diode, be sure the banded (cathode) end is installed to the common white wire.

The diode is used to prevent voltage from gaining access to the microprocessor board through the float switch.

To Check Diode

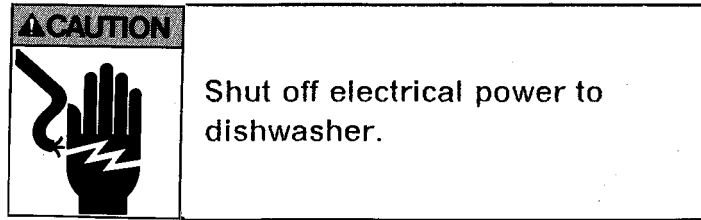

Using R x 10K scale on an ohmmeter, check for continuity across the diode. Continuity should be seen in one direction only. With the test lead reversed, no continuity should be seen.

BLOWER ASSEMBLY

The blower assembly is located in the front lower right corner of the dishwasher. For ease of service, it is recommended the complete blower and motor be removed as an assembly and then serviced.

To Remove

1. Remove lower toe plate and access panel.
2. Take out 1 screw (right hand side) from blower mounting bracket and move assembly down to disengage a mounting tab on the left side.

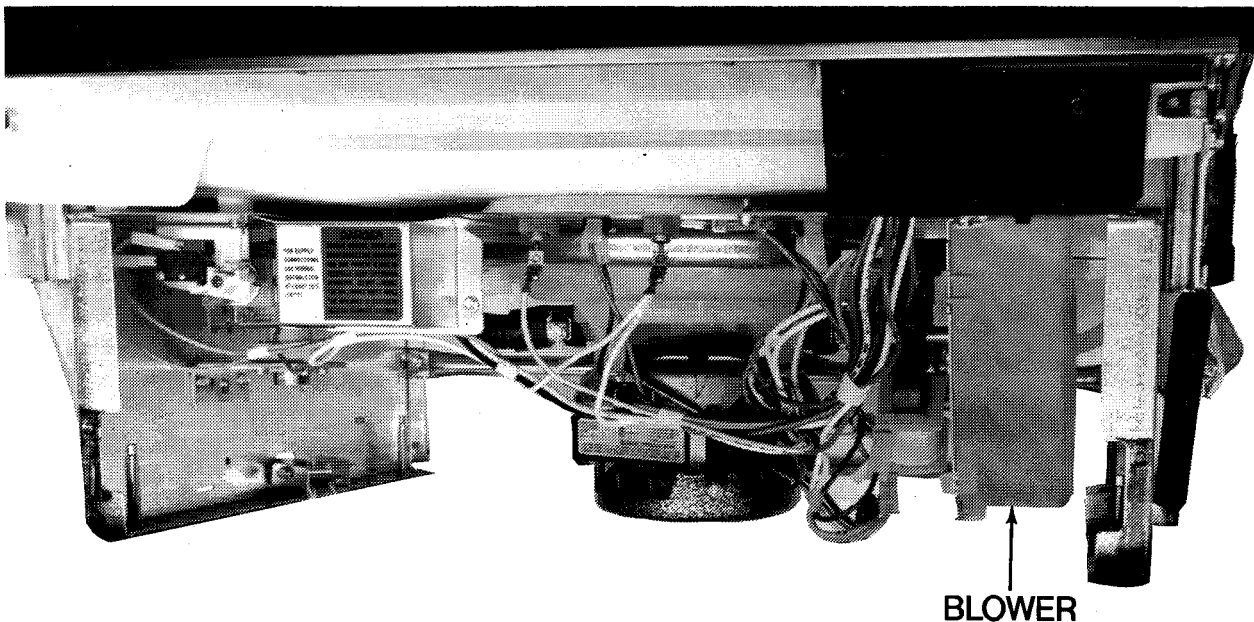

3. Disconnect wires from blower motor and motor start relay.

To Disassemble And Replace Blower Wheel Or Motor

1. Disengage polypropylene blower from mounting bracket.
Note: Each tab must be pushed away from mounting bracket.
2. Pull off blower wheel from motor shaft.
3. Remove 2 screws holding motor assembly to mounting bracket.

Note: When reinstalling blower wheel, push wheel on until hub is flush with motor shaft.

START RELAY

The start relay is mounted on the right hand side (attached to blower housing) and consists of a coil and a switch. The coil is in series with the main winding in the motor. When the motor is first energized, the current draw in this series circuit is enough to close the switch in the start relay. This closed switch provides a path for neutral to the wash or drain start winding and depending on what part of the cycle the dishwasher is in, starts the motor in that direction. Once the motor is up to speed, the current draw decreases and the coil can no longer hold the switch closed. When the switch opens, the wash or drain start winding drops out of the circuit.

Note: The relay has to be in an upright position to work properly.

Check The Start Relay

To check the relay, remove the three wires and the bolt that attaches the relay to the blower. With an appliance meter, check for continuity across the coil from the yellow terminal to the white terminal. A good coil will show continuity across the terminals. If you have an open circuit, replace the relay. To check the switch part of the relay, turn the relay upside down. Check from the red-white terminal to both of the coil terminals for continuity. A good switch will show continuity across both terminals. If you have an open circuit, replace the relay.

Note: Do not make live voltage check across coil.

FLOAT ASSEMBLY

The float assembly consist of a float, float guide, float switch, actuator lever and a float switch bracket.

The float assembly is designed to control the amount of water entering the dishwasher (approximately 2 gallons) on each fill. When the proper amount of water has entered the product (level with the heating element), the float will have risen enough to allow the actuator lever to disengage the float switch. With the float switch open, the electrical circuit to the water valve is broken and the valve will shut off.



FLOAT

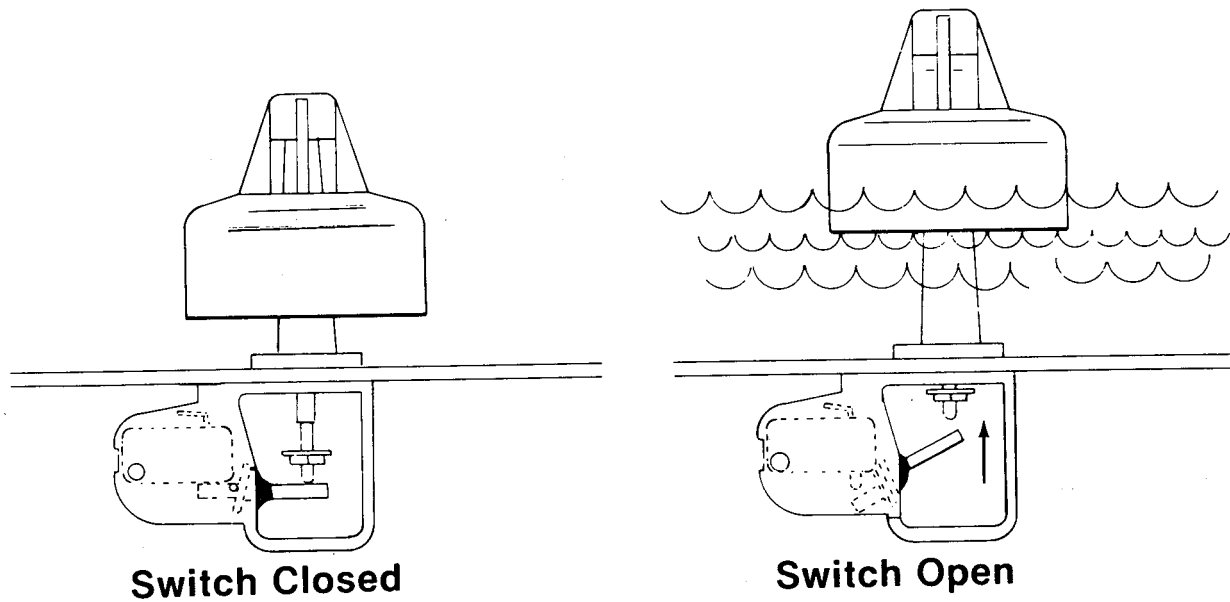

Should for some reason the float assembly fails to break electrical power to the water valve, the timer (in approximately 100 seconds) will automatically do so.

Note: If the float is sticking, look for a build-up of undissolved detergent and grease between the float the float guide. Clean both and advise customer on use of adequate amounts of detergent and 140-150°F water temperature as it enters the dishwasher.

CAUTION

Always shut off electrical power to dishwasher before beginning any service procedure.

To Remove Float

Remove access and toe panels. Refer to Front Panel, Access and Toe Panels, as needed.

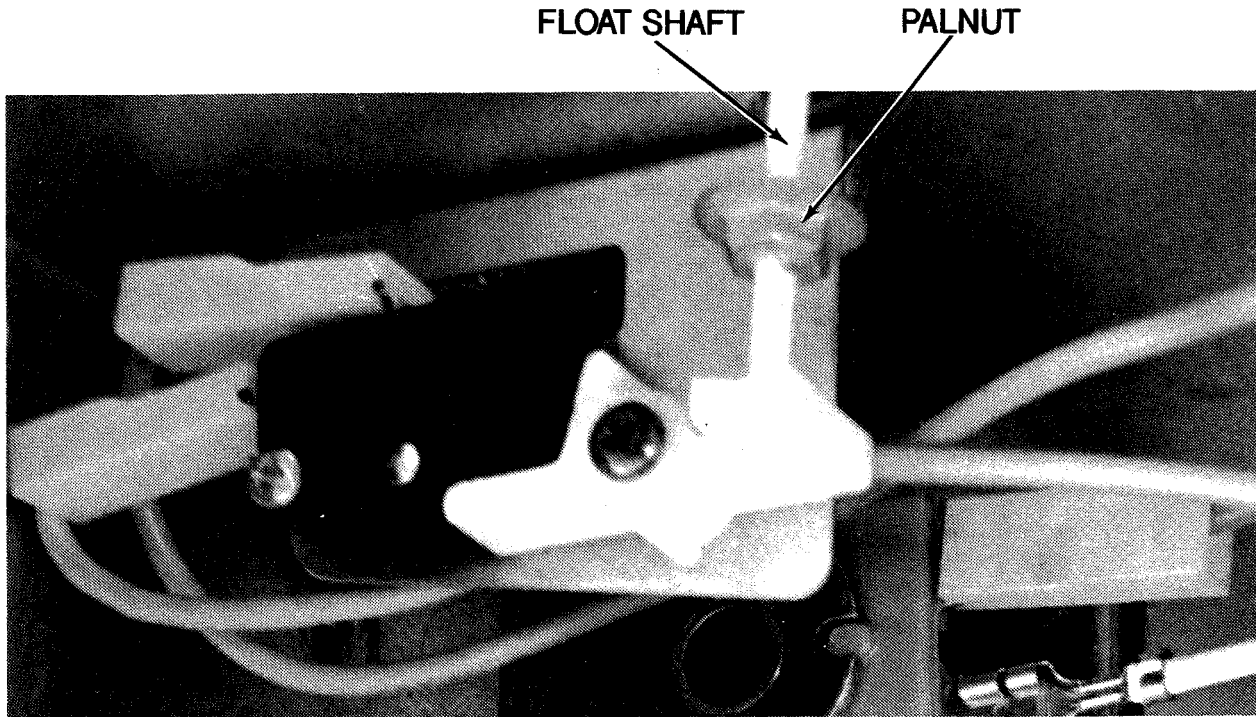

1. Reach inside and remove the palnut from the float shaft.

Note: You may find removal easier if you grasp the palnut with one hand and turn the float counterclockwise with the other.

CAUTION:

Replace the float if the end of the shaft twists off.

2. Pull the float up and out of the float guide.

To Remove Float Switch Bracket

Remove float.

Remove 2 screws securing float switch and bracket to base.

To Remove Actuator

Remove screw securing actuator to bracket.

To Remove Float Switch

Remove access and toe panels. Refer to Front Panel, Access and Toe Panels, as needed.

1. Remove both wire leads to switch.
2. Remove screw securing switch to bracket.

Note: A screw is used to secure the switch to the sheet metal bracket.

To Check Float Switch

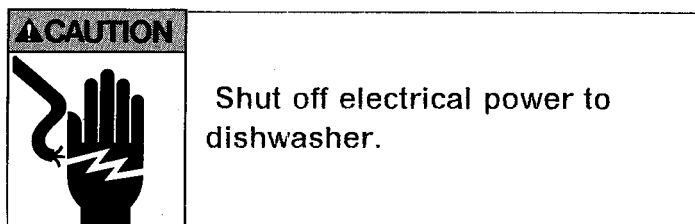

We recommend a continuity check be performed across the terminal of the float switch, using an ohmmeter. The switch should show a closed circuit (continuity) with no water in the tub. The switch should show an open circuit (no continuity) when the float is manually lifted.

In unfamiliar with use of ohmmeter or performing a continuity check, refer to Electrical Test Equipment section.

VENT COVER

The vent cover is located on the right-hand side of the dishwasher tub. It will not be necessary to remove the dishwasher from its installation.

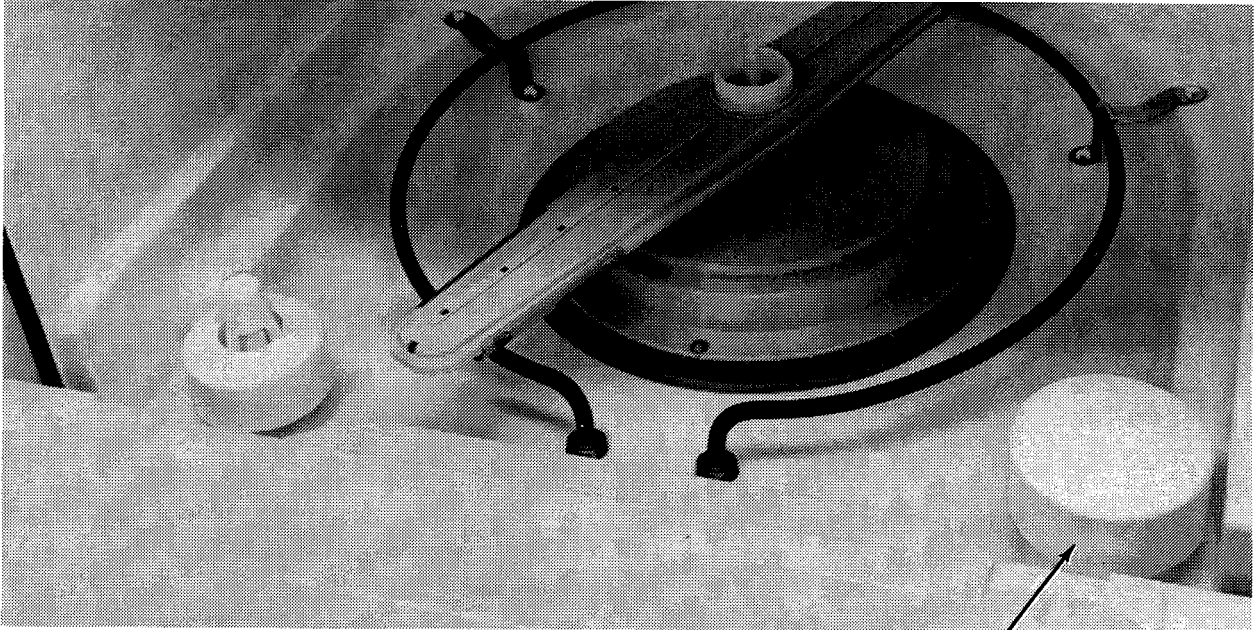

To Remove Vent Cover

VENT COVER

Remove lower dishrack.

1. Remove one torx screw from inside dishwasher holding vent cover to tub.
2. Remove cover and air valve from tub inlet.

HEATING ELEMENT

A low watt density heating element rated at 650 watts is used on the dishwasher. The element will assist in the drying process when the "Power Dry" option is selected and on some models will maintain or increase the water temperature during the wash cycle.

Removal of the heating element does not require removal of the dishwasher from its undercounter installation.

To Check Heating Element

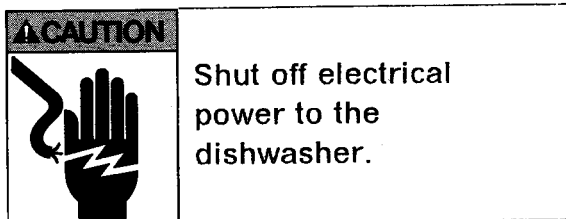

We recommend a continuity check be performed across the heating element terminals in order to determine whether or not a circuit is available through the element. Continuity should be seen. It is also suggested a continuity check be performed between the sheath of the element and dishwasher ground. No continuity should be seen.

Use of an ohmmeter will allow completion of these checks.

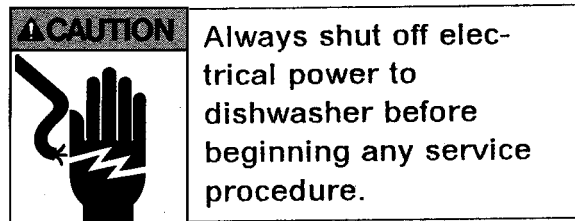
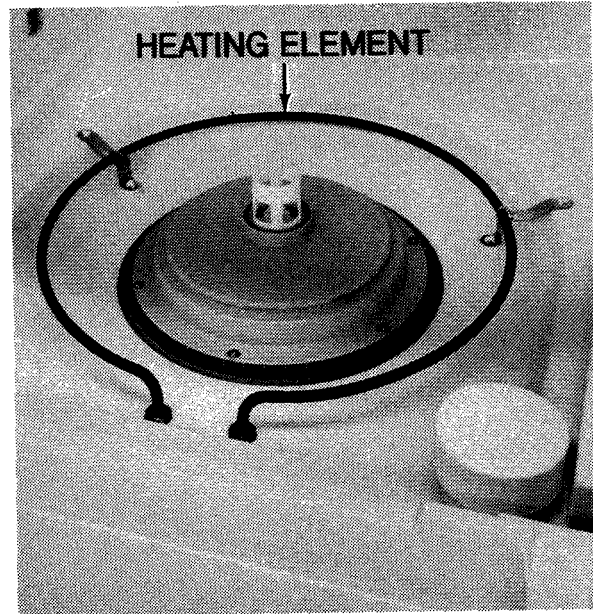

To Remove Heating Element and Hooks

1. Remove four screws holding access and toe panels.
2. Remove wires from heating element terminals.

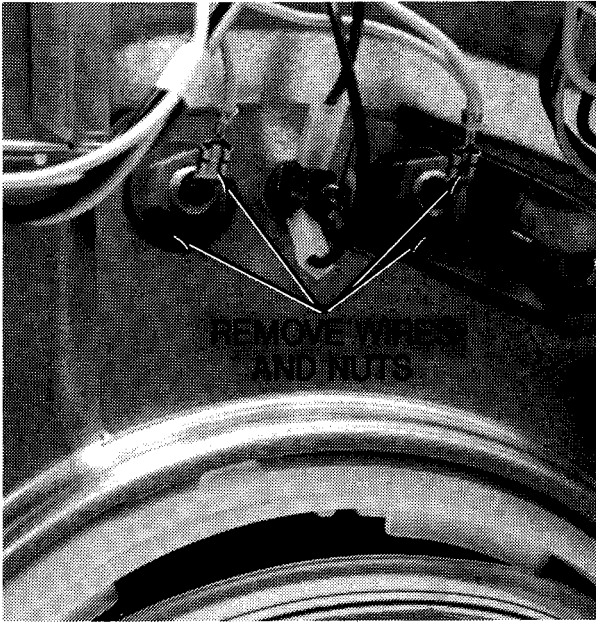

3. Remove two nuts (from bottom of tub) securing heating element to tub. The ground connection for the heating element and two thermostat mounting clips will also be removed at this time.
4. Release the heating element from the two rear heater hooks and lift the heating element out of the tub. Note the sealing washer on each lead of the heating element.

When replacing the element, carefully inspect the sealing washers. If there is

any doubt as to the condition of these washers, they should be replaced.

To Remove Heater Hooks

From inside dishwasher, simply pry heater hook from tub retainers.

HEATER HOOKS

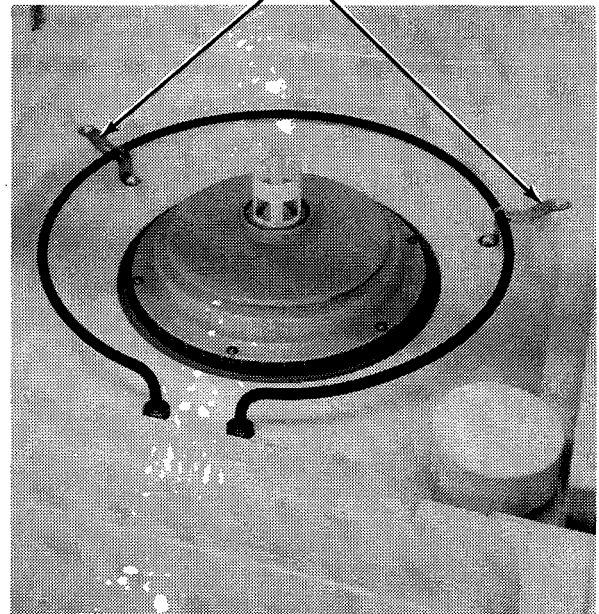

<p>CAUTION</p>	<p>Always shut off electrical power to dishwasher before beginning any service procedure.</p>
-----------------------	---

WATTAGE READING

⚠ CAUTION	The following are live voltage checks.
	

If a specific wattage reading is needed, take an amperage reading at YEL-BLK of the heating element and multiply the reading by available voltage (Amps x Volts = Watts). A normal amperage reading during dry cycle with power to the element is 5 1/2 amps.

Note: Refer to Electrical Test Equipment section of this manual if unfamiliar with use of an ammeter.

WOOD TOP

These models use a top made of wood composition core with hardwood laminated strips permanently bonded to the top and edges of the core. We recommend periodic treating of the laminated top with a non-toxic mineral oil.

To Remove Wood Top

Remove two screws securing wood top to mounting flange.

REMOVE SCREWS



Pull top forward to disengage spacer washers from slots in rear of cabinet top.

CABINET

To Remove Cabinet

Remove wood top.

1. Remove access and toe panels.



2. Disconnect the power cord from the wire leads in the terminal box and disconnect the fill hose from the water valve and drain hose from the power module.
3. Remove front and rear cabinet screws securing cabinet to tub and base supports.

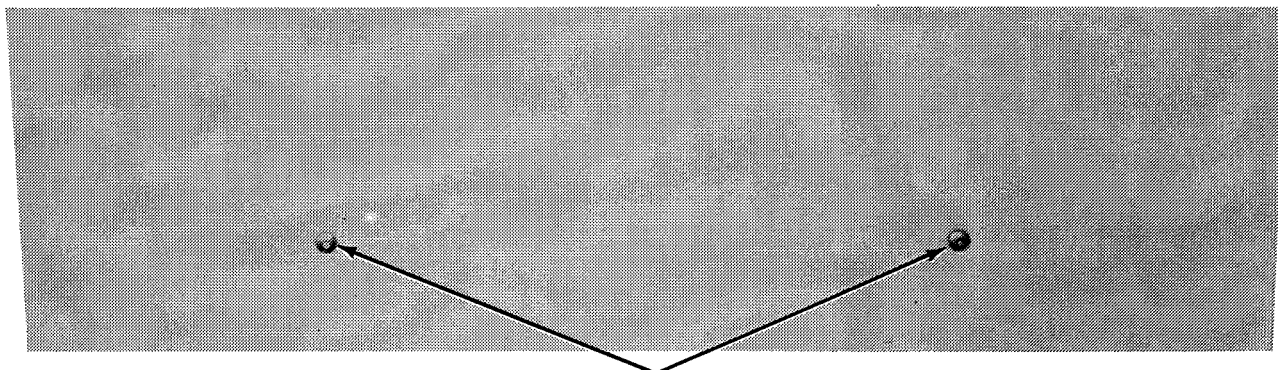

4. Remove cable strap from "U" bracket holding hoses.
5. Remove inlet hose from water valve and drain hose from pump module.
6. Remove cabinet.

CASTERS

To Remove Casters

Remove access and toe panels. Refer to Front Panel, Access and Toe Panels, as needed.

1. With a screw driver pry caster from socket.
2. Lift or block dishwasher up and remove caster.

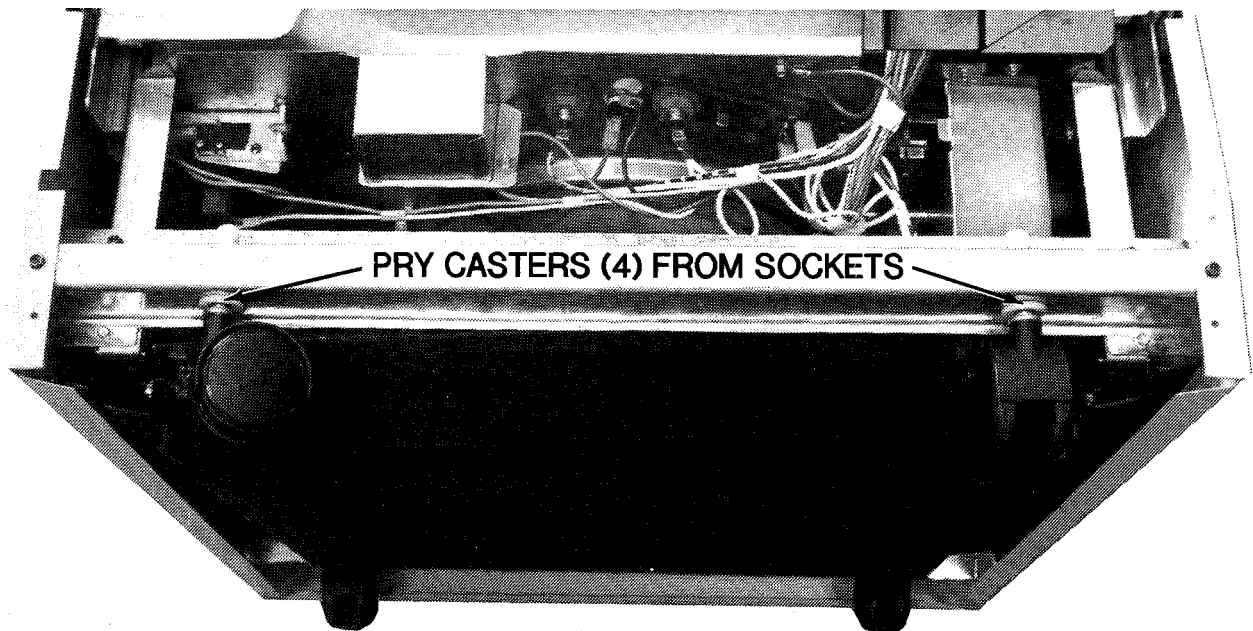

RETAINER FOR FAUCET COUPLER

The retainer provides a storage area for the faucet coupler when the dishwasher is not in use.



To Remove Retainer

Remove access and toe panels.

1. Disconnect the power cord from the wire leads in the terminal box and disconnect the fill hose from the water valve and drain hose from the power module. Refer to Faucet Coupler and Power Cord, as needed.
2. Remove wood top and cabinet.
3. Pull faucet coupler and power cord out of retainer.

Note: It will be necessary to remove power cord from the strain relief on the base frame.

4. Remove five palnuts securing retainer to cabinet.

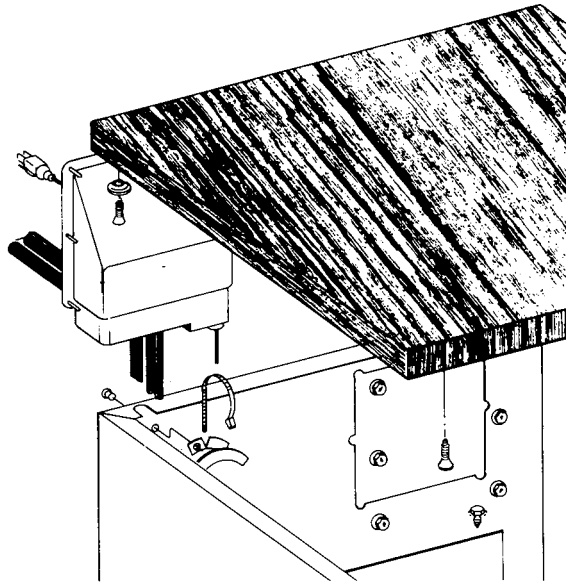

FAUCET COUPLER

The faucet coupler provides a means for filling and draining the convertible dishwasher. It connects to a special adapter attached to the faucet at the sink. When not in use, the faucet coupler stores in the retainer on the back of the dishwasher.

Note: Component repair of coupler is NOT RECOMMENDED. If necessary, REPLACE COMPLETE COUPLER (with hoses).

To Remove Faucet Coupler

1. Remove access and toe panels.
2. Remove fill hose from water valve.
3. Remove drain hose from module assembly.
4. Remove wood top. Refer to Wood Top, Cabinet and Base Frame.
5. Cut tie strap securing hoses to hose support and pull faucet coupler and hoses out of retainer.

SECTION 4. GENERAL INFORMATION

Information covered in this section includes:

1. Specifications
2. Warranty
3. Models and Features
4. Cycles
5. Schematics

SPECIFICATIONS

BASIC DIMENSIONS

Built-In Models

33 3/4-35 1/4" H x 24" W x 23 1/2" D

Note: Depending on the depth of the cabinet opening (cavity) and if the dishwasher is installed adjacent to drawers or a door, the control panel may project beyond the cabinet opening just enough to interfere with opening of drawers or a door.

ELECTRICAL SUPPLY 120 Volt; 60 Hz. All models require 15 amp fuse.

WATER SUPPLY Water pressure should be 15-120 p.s.i. (1.06-8.44 kg / sq. cm). Water temperature should be 140°F. when it enters the dishwasher.

DRAIN 1/2" I.D. flexible drain hose furnished. High drain loop positioned on side of dishwasher.

MOTOR AND PUMP 1/3 H.P. reversible; two-stage pump for circulation and draining.

WEIGHT (Crated/Uncrated)

Built-In Models

Dependably Quiet* Models - 100 lbs.(45 KG)/85 lbs.(39kg)

Dependably Quite* Plus Models - 115 lbs.(52 kg)/100 lbs.(46 kg)

Added weight due to additional insulation.

TRIM KIT - Built-In Models Only

Door Panel Insert

1/4" x 18 9/32" x 23 11/16"

(.64 cm x 46.4 cm x 60.2 cm)

Access Panel Insert

1/4" x 4 21/32" x 23 11/16"

(.64 cm x 11.8 cm x 60.2 cm)

WARRANTY

MODELS AND FEATURES



CYCLES

MAYTAG DISHWASHER CYCLES

POTS & PANS	PRE-WASH	RINSE	RINSE	MAIN WASH	RINSE	RINSE	DRY	99 min.	11 gal.
NORMAL CYCLE		PRE-WASH	RINSE	MAIN WASH	RINSE	RINSE	DRY	84 min.	9 gal.
LIGHT/CHINA			RINSE	MAIN WASH	RINSE	RINSE	DRY	76 min.	7 gal.
QUICK CYCLE				MAIN WASH	RINSE	RINSE		17 min.	5 gal.
RINSE & HOLD						RINSE		7 min.	2 gal.

WATER HEATING OPTIONS

Temp Boost Sensor - Thermostatically guarantees proper water temperature and will extend main wash if necessary to reach proper water temperature.

Sani Rinse - The heating element is on during all rinses.

TOUCH MODELS

*POWER SCRUB	PRE-WASH	SANI RINSE	SANI RINSE	EXTENDED MAIN WASH	SANI RINSE	SANI RINSE	DRY	105 min.	11 gal.
*POTS & PANS	PRE-WASH	SANI RINSE	SANI RINSE	MAIN WASH	SANI RINSE	SANI RINSE	DRY	99 min.	11 gal.
** NORMAL CYCLE		PRE-WASH	RINSE	MAIN WASH	RINSE	RINSE	DRY	84 min.	9 gal.

* Programmed Temp Boost Sensor and Sani Rinse

**Programmed Temp Boost Sensor

SCHEMATICS

An Electrical Schematic is packed in every unit. It is located inside of the access panel. Listed below are the Electrical Schematics for models covered in this service manual.

- 9920
- 9905 8890
- 9200 8860 8750 7910
- 8530
- 8460
- 8450
- 8330 8270 8260 8250 7400
- 8240
- 7600 7500
- 7550
- 7450
- 7300
- 5910
- 4910

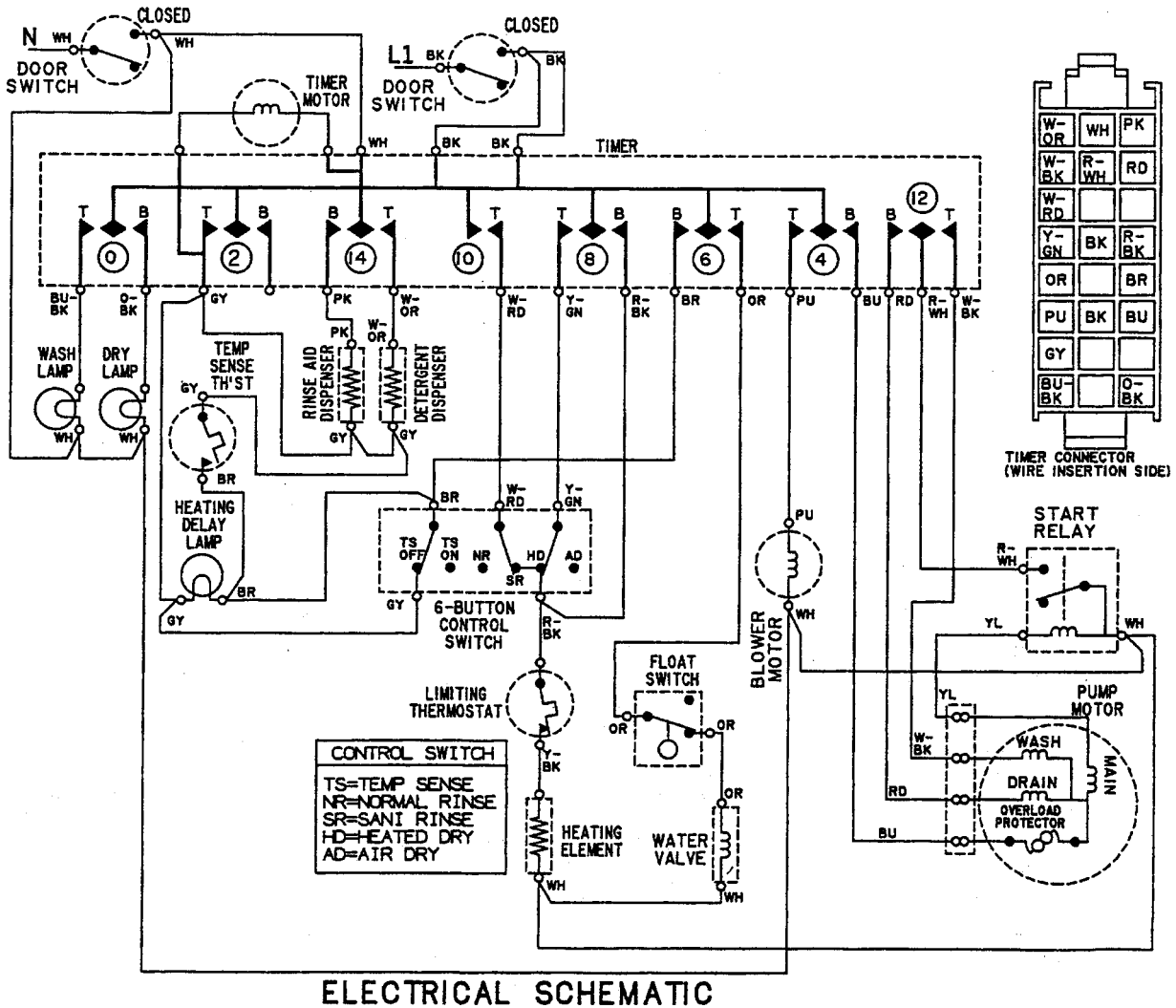
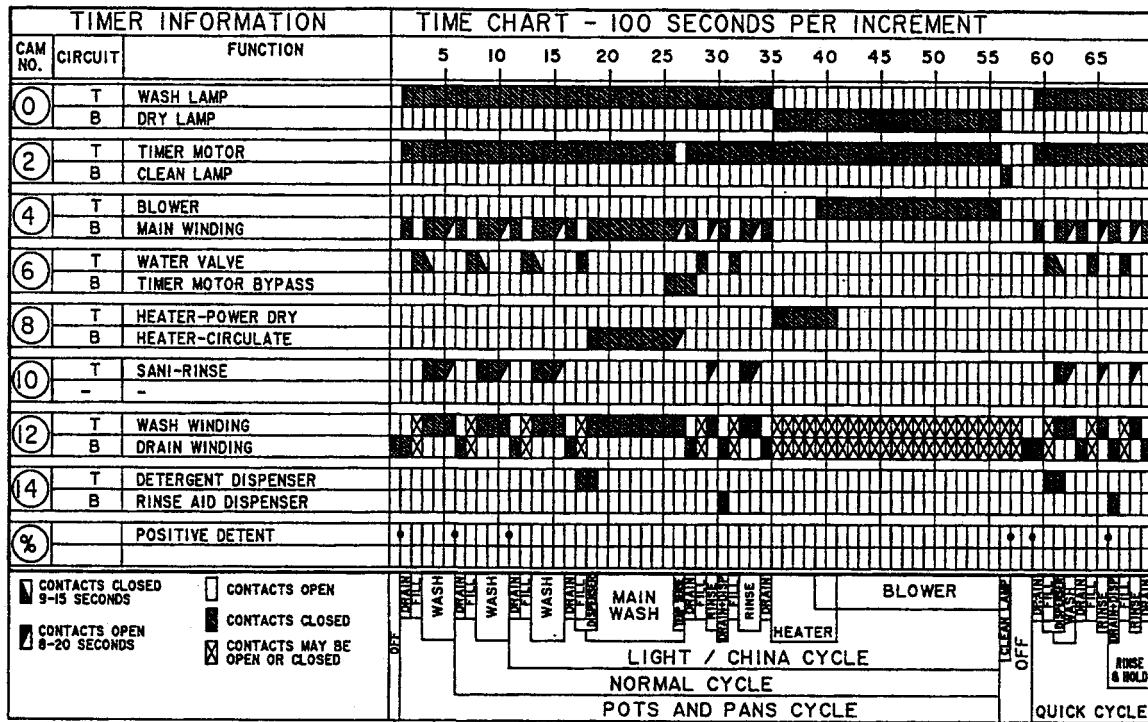

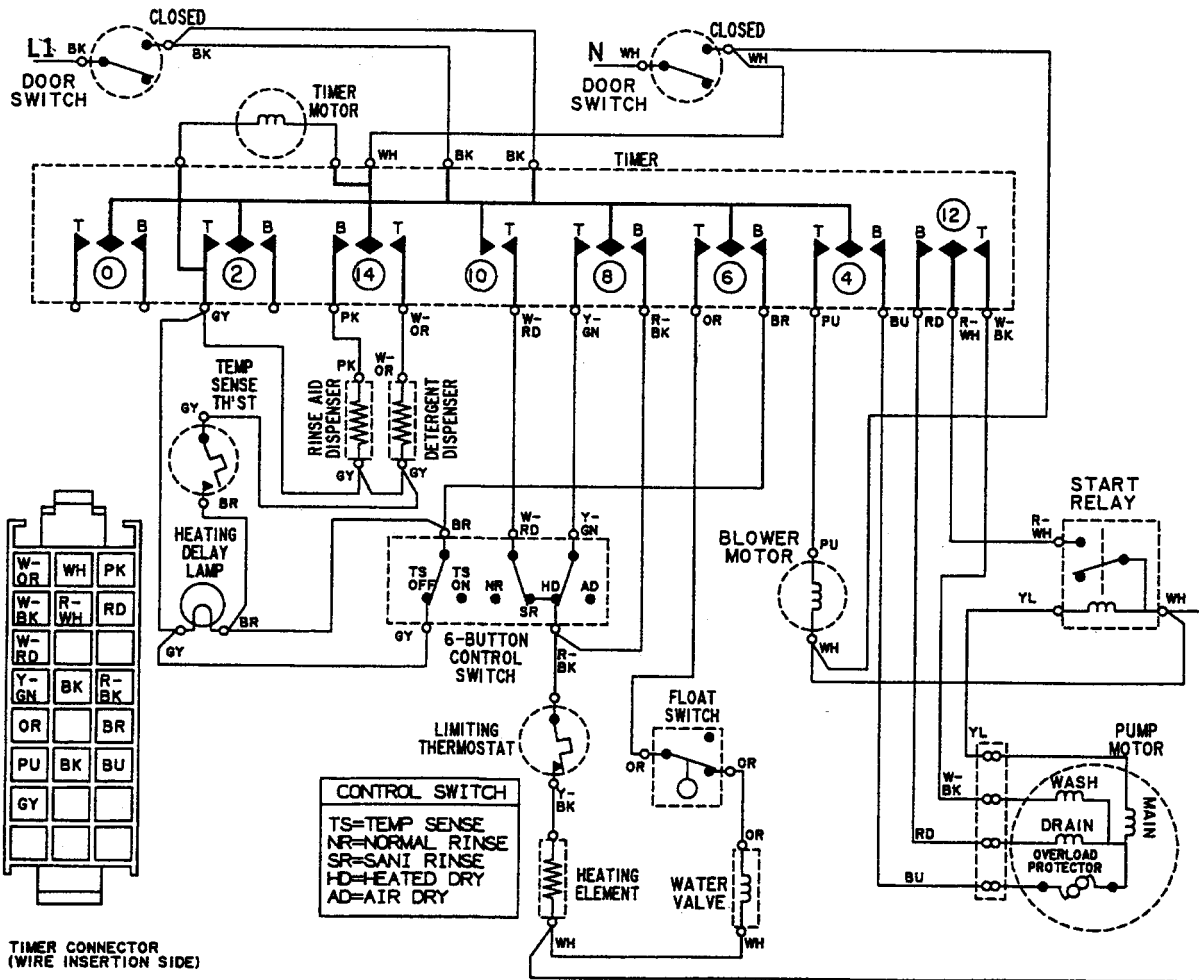
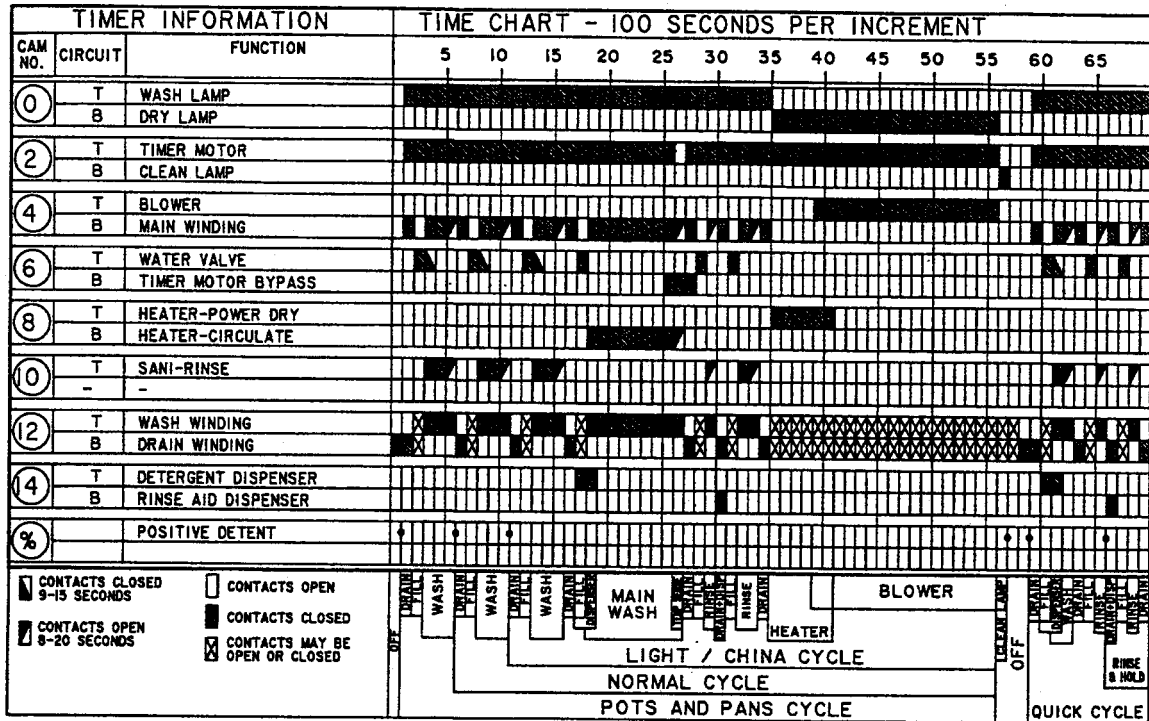

ELECTRICAL SCHEMATIC

TIMER INFORMATION			TIME CHART - 100 SECONDS PER INCREMENT											
CAM NO.	CIRCUIT	FUNCTION	5	10	15	20	25	30	35	40	45	50	55	60
0	T	TIMER MOTOR	[Solid black bar]											
	B	-	[Blank]											
2	T	HEATER-POWER DRY	[Solid black bar]											
	B	HEATER-CIRCULATE	[Solid black bar]											
4	T	BLOWER	[Solid black bar]											
	B	MAIN WINDING	[Solid black bar]											
6	T	WATER VALVE	[Solid black bar]											
	B	TIMER-MOTOR BYPASS	[Solid black bar]											
8	T	WASH WINDING	[Cross-hatched bar]											
	B	DRAIN WINDING	[Cross-hatched bar]											
10	T	DETERGENT DISPENSER	[Solid black bar]											
	B	RINSE AID DISPENSER	[Solid black bar]											
%		POSITIVE DETENT	[Dotted bar]											

CONTACTS CLOSED 9-15 SECONDS	CONTACTS OPEN	CONTACTS CLOSED	CONTACTS MAY BE OPEN OR CLOSED
------------------------------	---------------	-----------------	--------------------------------

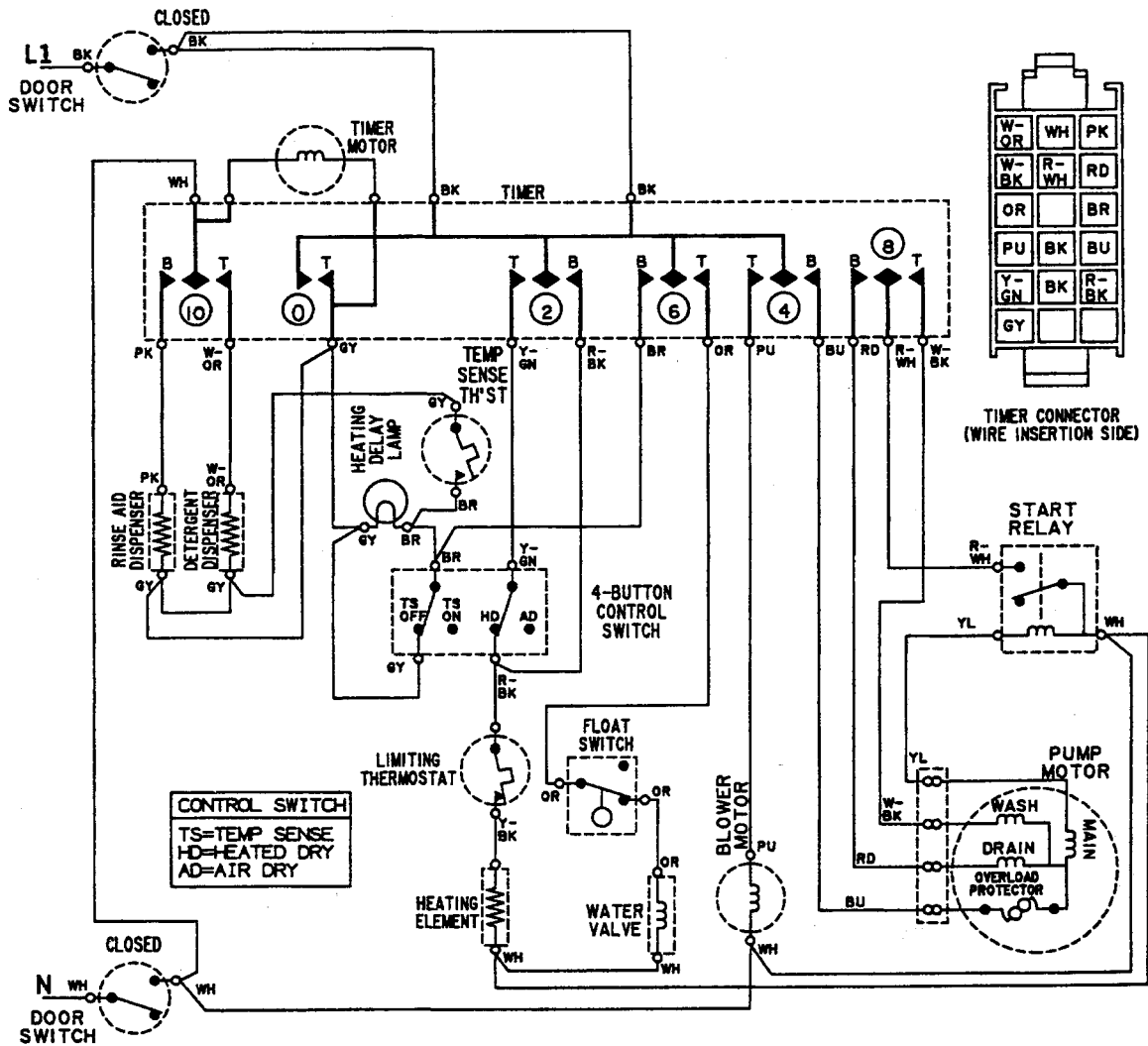

ELECTRICAL SCHEMATIC

TIMER INFORMATION			TIME CHART - 100 SECONDS PER INCREMENT											
CAM NO.	CIRCUIT	FUNCTION	5	10	15	20	25	30	35	40	45	50	55	
0	T	ON LAMP	[Solid black bar]											
	B		[Grid]											
2	T	TIMER MOTOR	[Solid black bar]											
	B	-	[Grid]											
4	T	BLOWER	[Solid black bar]											
	B	MAIN WINDING	[Solid black bar]											
6	T	WATER VALVE	[Solid black bar]											
	B	TIMER MOTOR BYPASS	[Grid]											
8	T	HEATER-POWER DRY	[Solid black bar]											
	B	HEATER-CIRCULATE	[Solid black bar]											
10	T	-	[Grid]											
	B	-	[Grid]											
12	T	WASH WINDING	[Cross-hatched bar]											
	B	DRAIN WINDING	[Cross-hatched bar]											
14	T	DETERGENT DISPENSER	[Solid black bar]											
	B	RINSE AID DISPENSER	[Solid black bar]											
%		POSITIVE DETENT	[Grid]											

	CONTACTS CLOSED 7-9 SECONDS		CONTACTS OPEN
	CONTACTS OPEN 8-20 SECONDS		CONTACTS CLOSED
	CONTACTS MAY BE OPEN OR CLOSED		

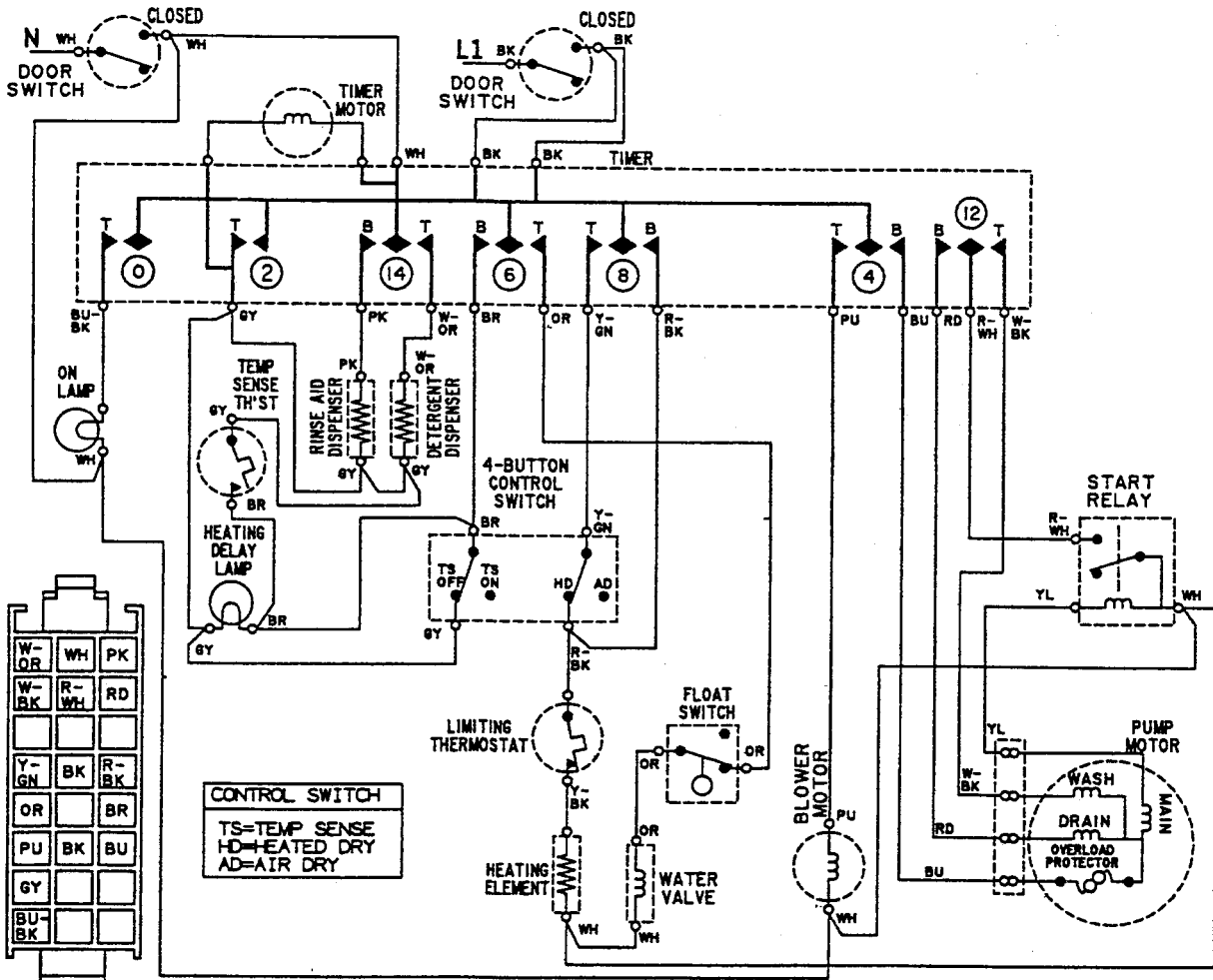

TIMER CONNECTOR (WIRE INSERTION SIDE)

ELECTRICAL SCHEMATIC

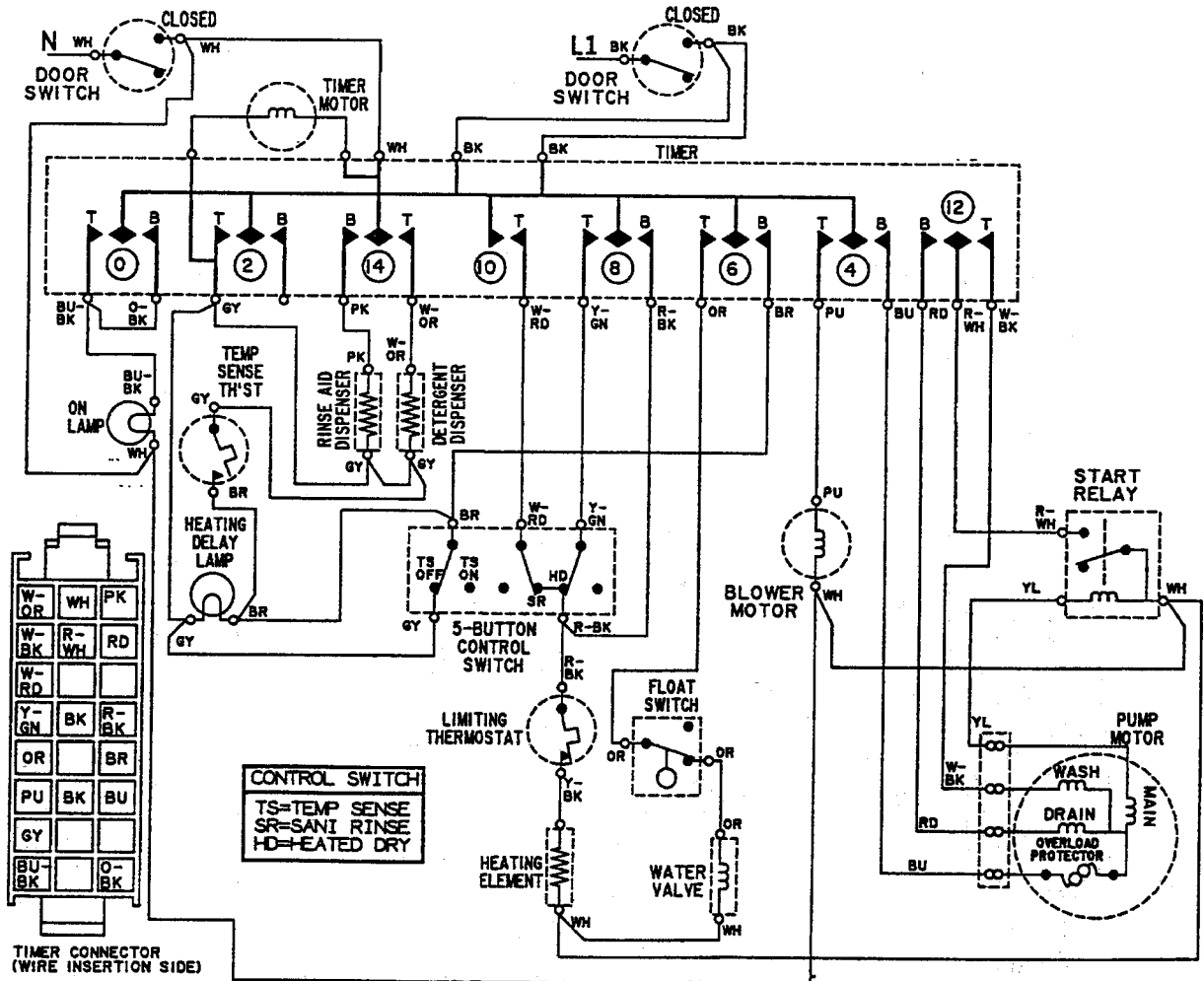
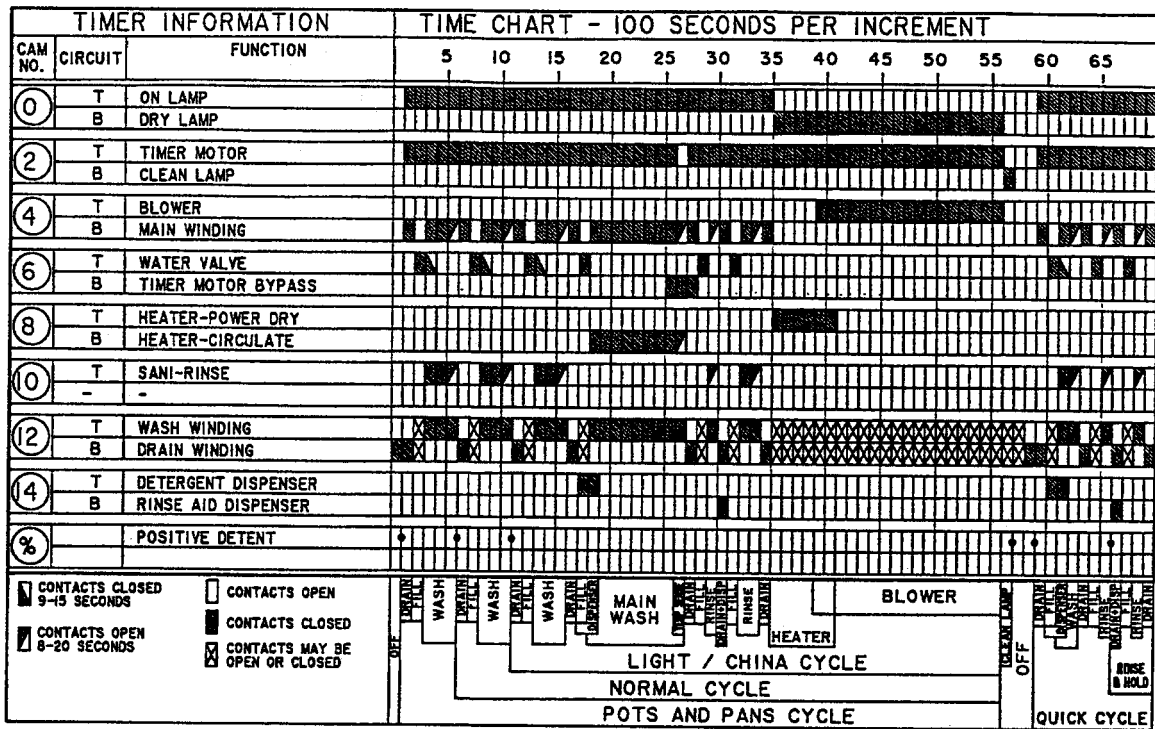

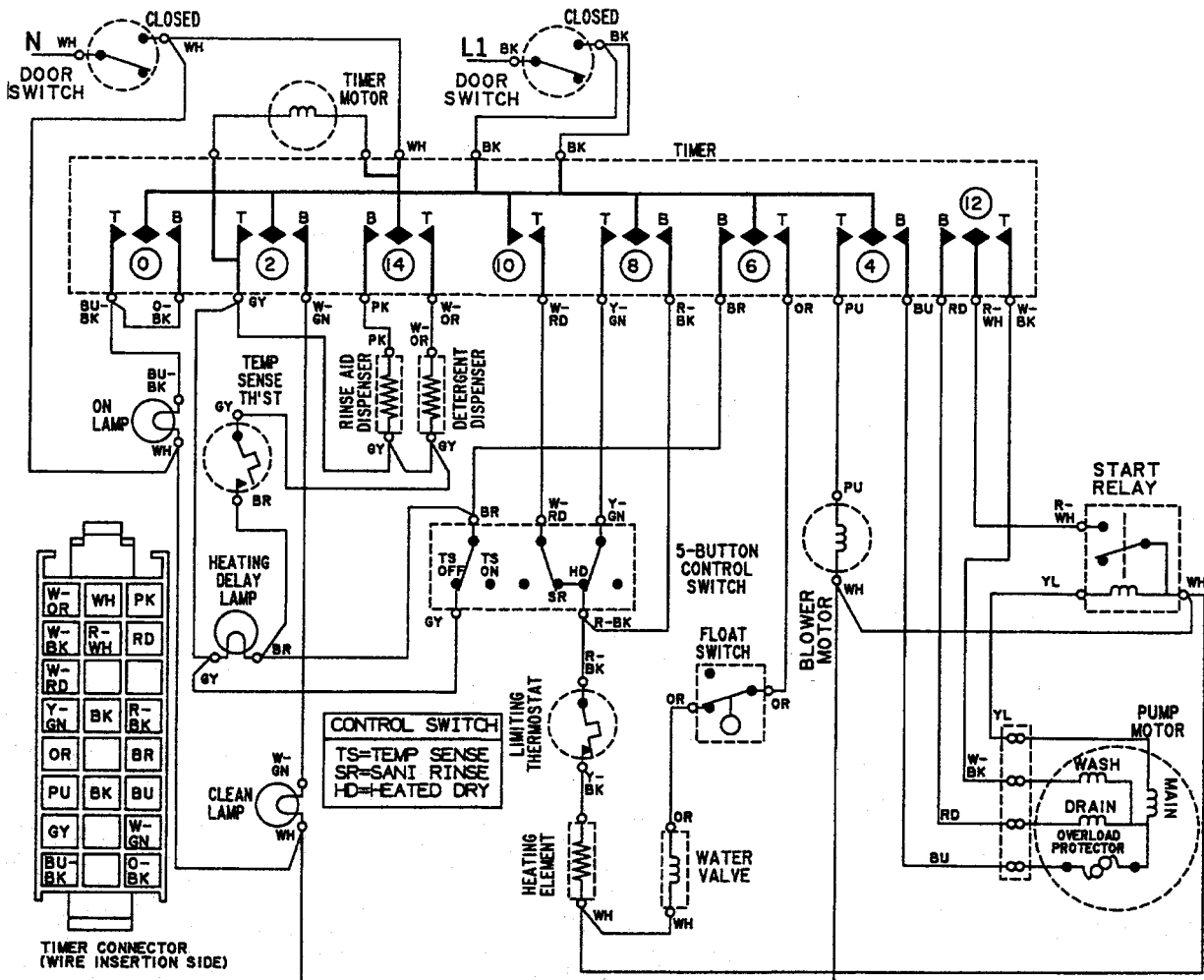
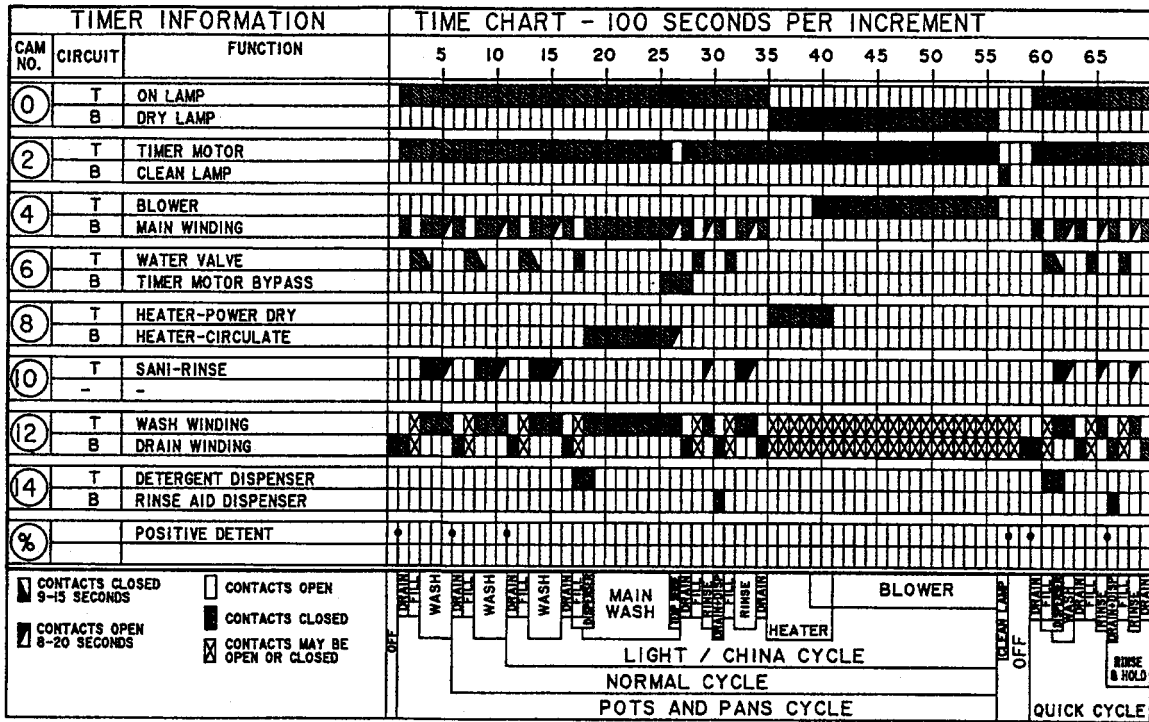

ELECTRICAL SCHEMATIC

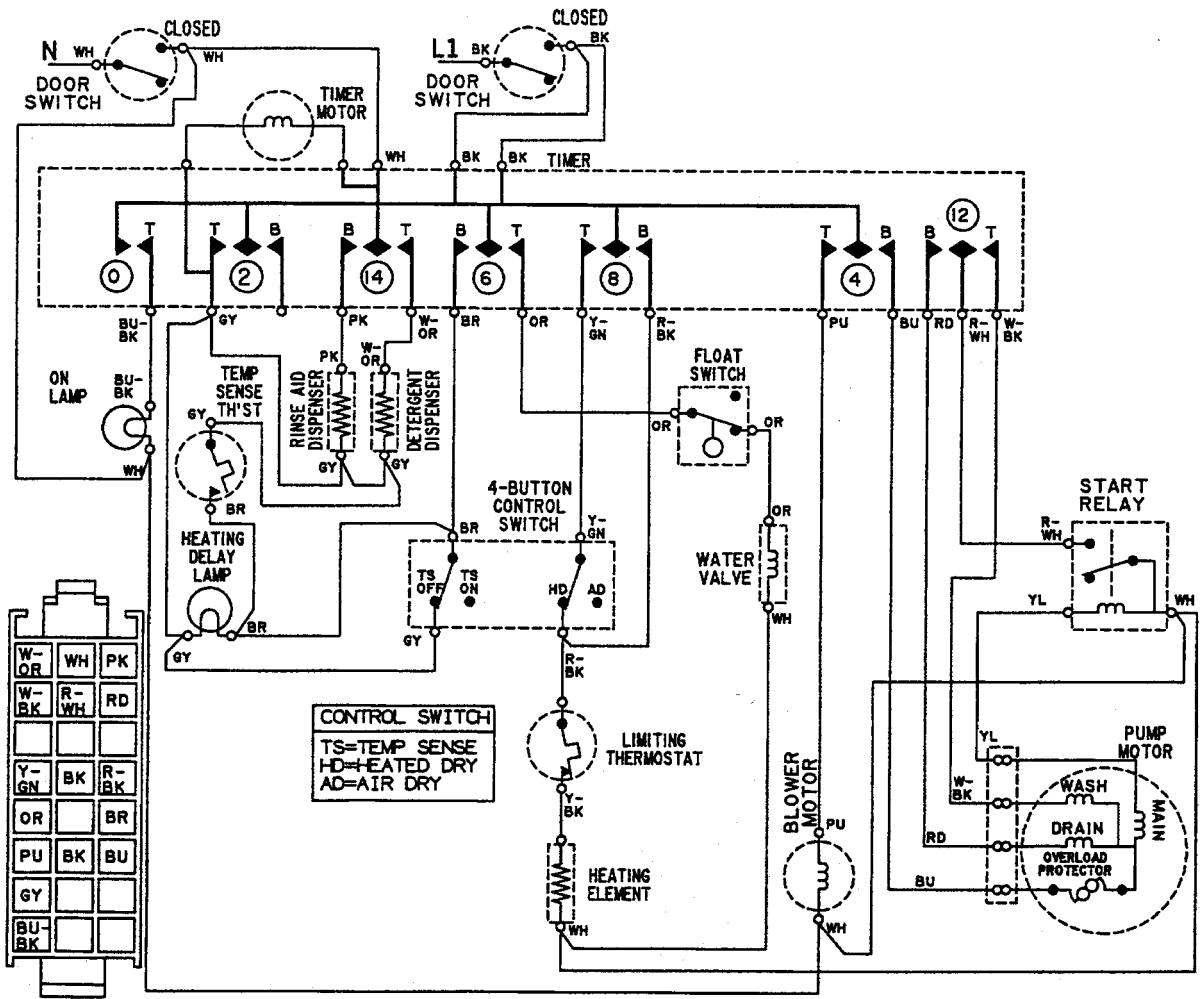
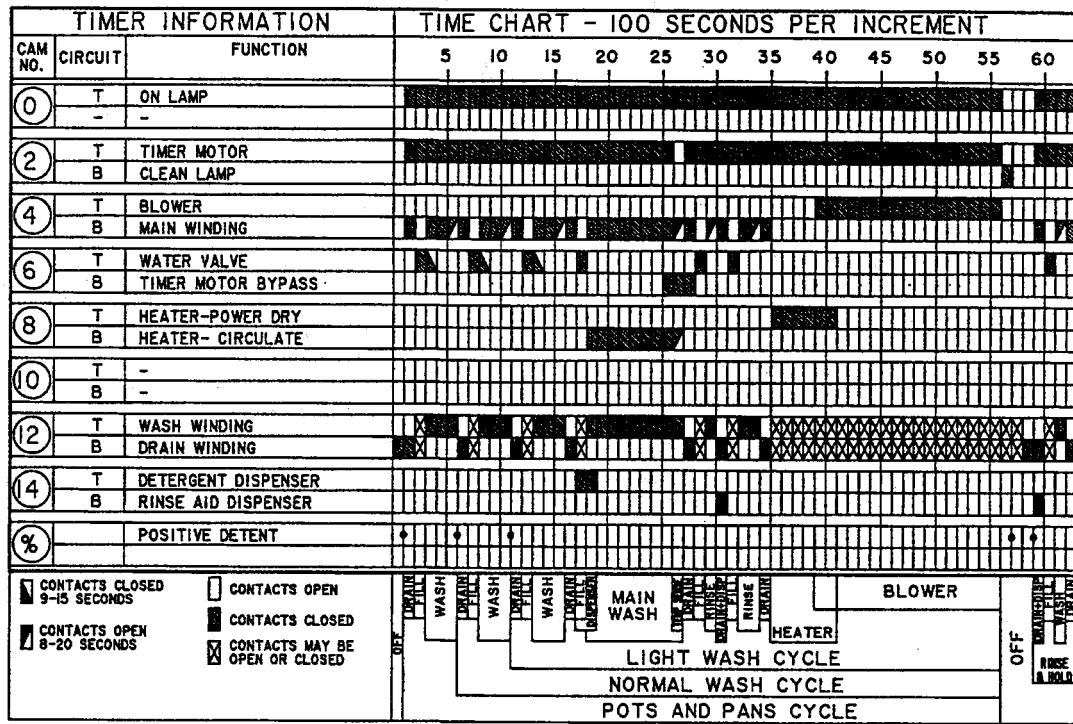

TIMER CONNECTOR (WIRE INSERTION SIDE)

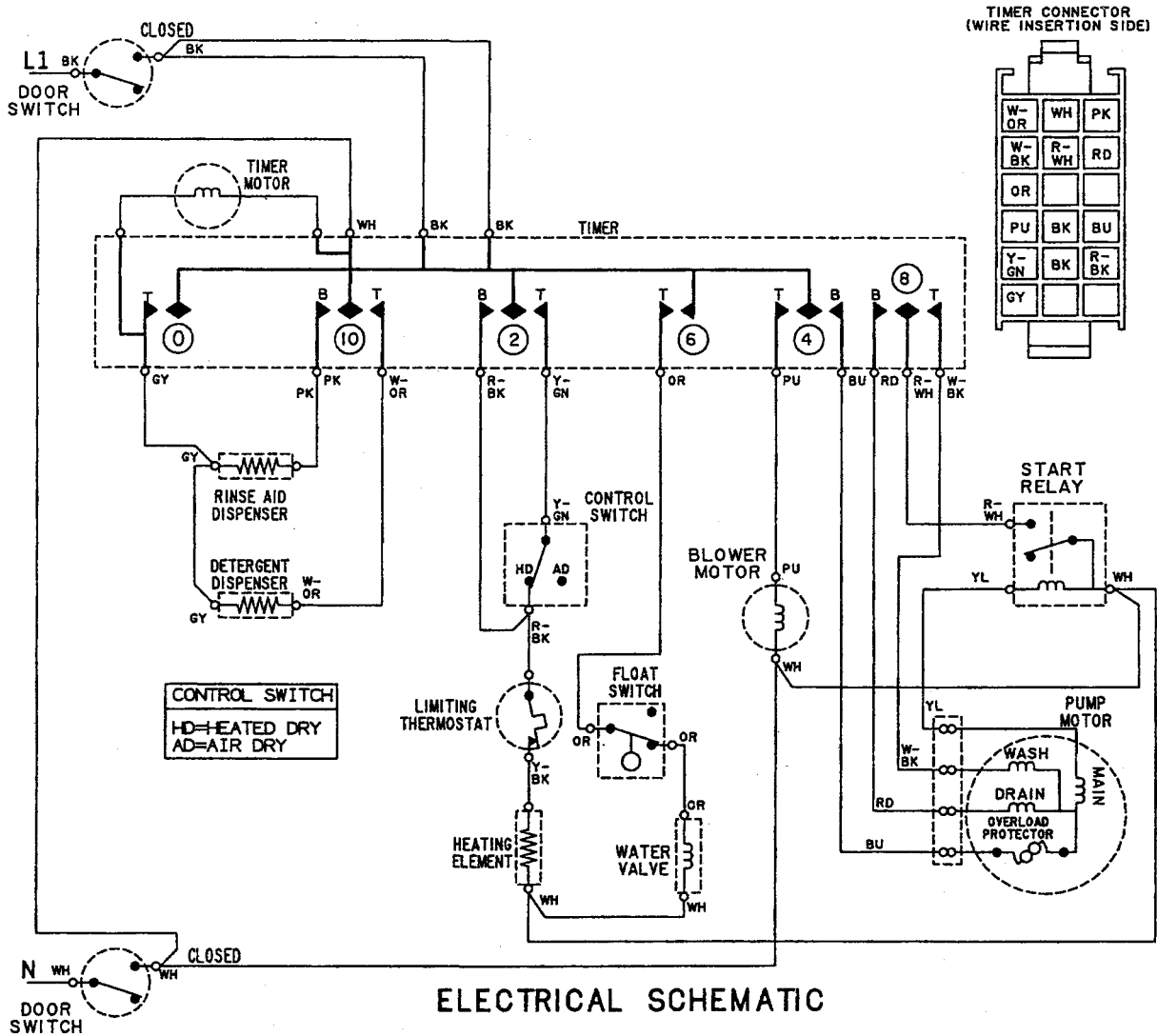
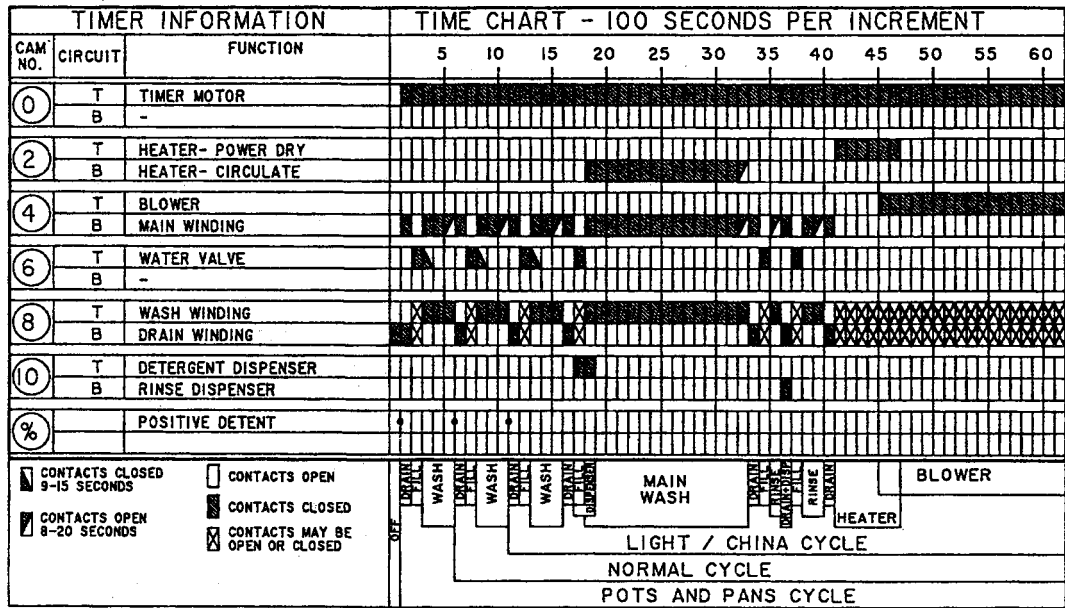

TIMER INFORMATION			TIME CHART - 100 SECONDS PER INCREMENT											
CAM NO.	CIRCUIT	FUNCTION	5	10	15	20	25	30	35	40	45	50	55	60
0	T	ON LAMP	[Shaded bar from 0 to 60]											
2	T	TIMER MOTOR	[Shaded bar from 0 to 60]											
	B	CLEAN LAMP	[Shaded bar from 0 to 60]											
4	T	BLOWER	[Shaded bar from 0 to 60]											
	B	MAIN WINDING	[Shaded bar from 0 to 60]											
6	T	WATER VALVE	[Shaded bar from 0 to 60]											
	B	TIMER MOTOR BYPASS	[Shaded bar from 0 to 60]											
8	T	HEATER-POWER DRY	[Shaded bar from 0 to 60]											
	B	HEATER- CIRCULATE	[Shaded bar from 0 to 60]											
10	T	-	[Blank]											
	B	-	[Blank]											
12	T	WASH WINDING	[Cross-hatched bar from 0 to 60]											
	B	DRAIN WINDING	[Cross-hatched bar from 0 to 60]											
14	T	DETERGENT DISPENSER	[Shaded bar from 0 to 60]											
	B	RINSE AID DISPENSER	[Shaded bar from 0 to 60]											
%		POSITIVE DETENT	[Dotted line from 0 to 60]											

[Shaded box]	CONTACTS CLOSED 9-15 SECONDS	[Open box]	CONTACTS OPEN
[Cross-hatched box]	CONTACTS OPEN 8-20 SECONDS	[Shaded box]	CONTACTS CLOSED
[Cross-hatched box]		[Cross-hatched box]	CONTACTS MAY BE OPEN OR CLOSED

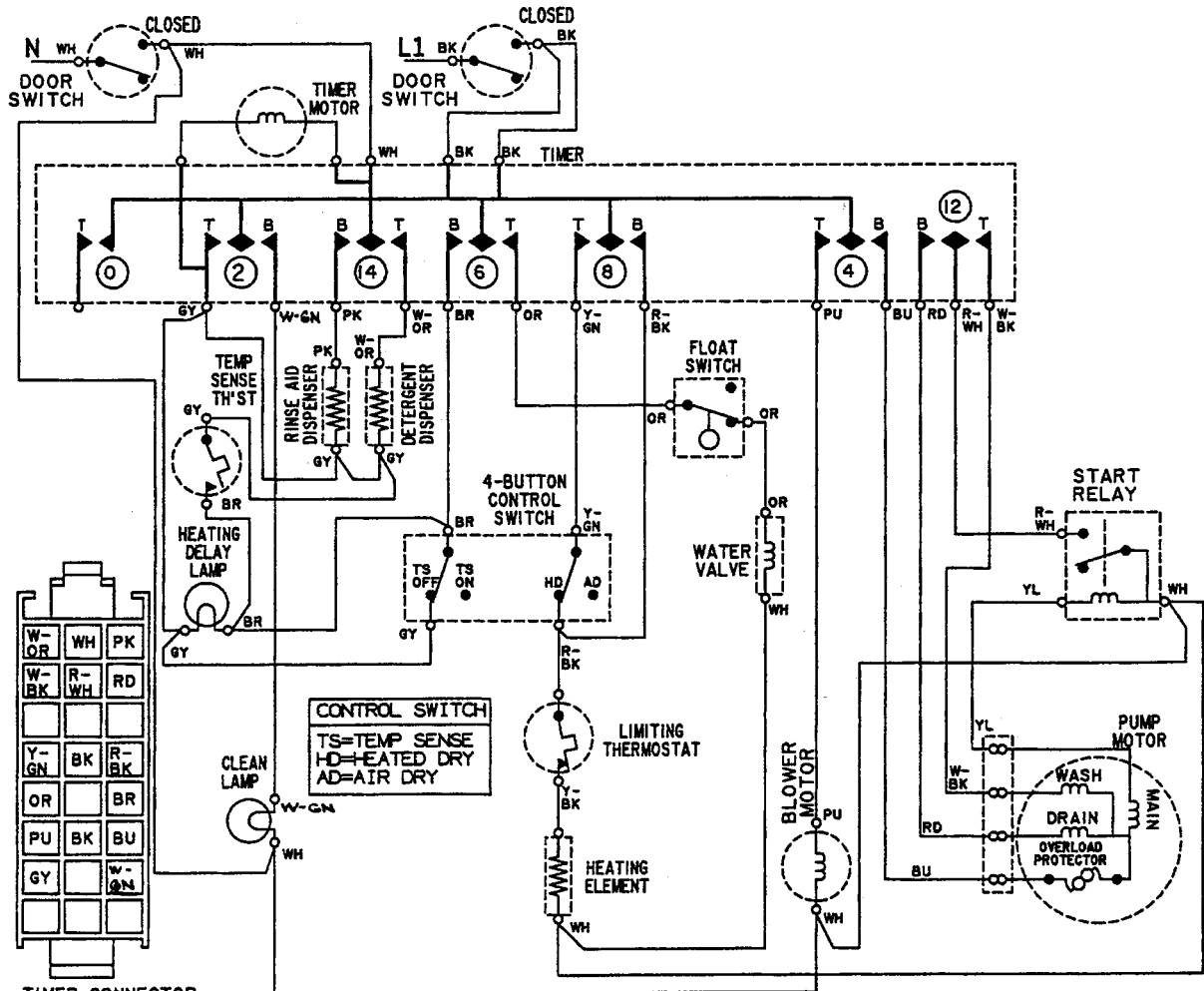

ELECTRICAL SCHEMATIC



MAYTAG

Maytag Appliances Sales Company

Customer Service
240 Edwards St.
Cleveland, TN 37311

MAYTAG

Maytag

**Dishwasher
IntelliSense™
Service Manual**

16007023
Issued 4/95
Revised 6/98



Contents

SECTION 1. SPECIFICATIONS	1-1
SECTION 2. WARRANTY	2-1
SECTION 3. CONTROL PANEL	3-1
FEATURES	3-1
VACUUM FLUORESCENT DISPLAY	3-3
SECTION 4. ELECTRICAL-MECHANICAL TROUBLESHOOTING	4-1
FIELD SERVICE TESTS	4-1
ELECTRICAL TROUBLESHOOTING: MODEL DWU9961	4-5
DIAGNOSTIC CHART	4-9
SECTION 5. SERVICE PROCEDURES	5-1
MICROPROCESSOR BOARD	5-1
TRANSFORMER	5-2
SENSOR CLUSTER	5-3
RINSE AID RESERVOIR WITH SENSOR	5-7
SECTION 6. SCHEMATIC	6-1

INTRODUCTION

This service supplement consists of service information pertaining to the

DWU9961 Maytag IntelliSense™ Model Dishwasher

For other service related information, refer to Maytag "07" Models Dishwasher Service Manual, part number 16000374.

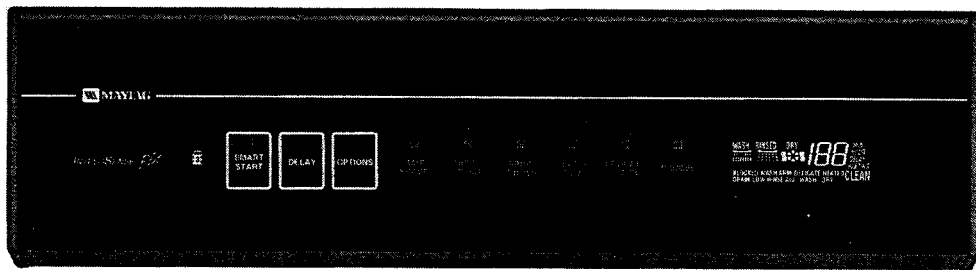

DWU9961

For additional information on issues encompassed in this manual, including safety issues, contact:

Maytag Customer Service
240 Edwards Street S.E.
Cleveland, TN 37311

Phone: 423-472-3333
FAX: 423-478-0649

SAFETY PRECAUTIONS

This service manual is intended to assist you in diagnosing conditions which may develop in the Maytag IntelliSense™ dishwasher. Electrical component testing is for the most part, made with an appliance test meter and consists of checking for open or closed circuits. Mechanical checks are made through sight and sound, along with the use of a clamp-on ammeter.

This manual is designed for the technician who is familiar with the operation and construction of Maytag products. Information contained in this manual is intended for use by a qualified service technician, familiar with proper and safe procedures to be followed when repairing an electrical appliance. All tests and repairs should be performed by a qualified service technician equipped with proper tools and measuring devices. All component replacements should be made by a qualified service technician, using only MAYTAG CUSTOMER SERVICE replacement parts.

Improper assembly or adjustment may occur if service or repair is attempted by persons other than qualified service technicians or if parts other than MAYTAG CUSTOMER SERVICE replacement parts are used. Improper assembly or adjustment can cause hazardous conditions.

▲CAUTION	There can be risk of injury or electrical shock while performing services or repairs. Injury or electrical shock can be serious or even fatal.
	

PERSONAL SAFETY PRECAUTIONS

Note: As a general rule, an appliance should always be disconnected from power source before attempting replacement of component parts.

This appliance must be properly grounded. Never plug the appliance into a receptacle which is not grounded adequately and in accordance with local and national codes. See installation instructions for grounding this appliance.

Appliances with the UL symbol on the data plate have been listed with Underwriters' Laboratories, Inc.; those with a CSA monogram on the data plate have been certified by the CSA Testing Laboratories as complying with Canadian Standards Association requirements. Nevertheless, as with any equipment using electricity and having moving parts, there are potential hazards. To use this appliance safely, the operator should become familiar with the instructions for operation of the appliance and always exercise care when using it.

IMPORTANT SAFETY NOTICE AND WARNING

The California Safe Drinking Water and Toxic Enforcement Act of 1986 (Proposition 65) requires the Governor of California to publish a list of substances known to the State of California to cause cancer or reproductive harm, and requires business' to warn customers of potential exposures to such substances.

SECTION 1. SPECIFICATIONS

BASIC	Height = 33 3/4" - 35 1/4" (85.7cm - 89.5cm)
DIMENSIONS	Width = 24" (61cm) Depth = 23 1/2" (59.7cm)
ELECTRICAL SUPPLY	120VAC/60HZ All models require 15 amp fuse.
WATER SUPPLY	Water pressure should be 15-120 P.S.I., (1.06-8.44 kg/sq.cm). Water Temperature should be 120°F - 140°F when it enters the dishwasher.
DRAIN	1/2" I.D. Flexible drain hose furnished. High drain loop positioned on side of dishwasher, maintain 32" height.
MOTOR & PUMP	1/3 Horsepower, reversible; two-stage pump for circulation and draining.
WEIGHT	CRATED = 118 lb. (53.5kg) UNCRATED = 103 lb. (46.7kg)
TRIM KIT	Door Panel Insert = 1/2" x 18-3/16" x 23-9/16" (.64cm x 46.4cm x 60.2cm) Access Panel Insert = 1/2" x 4-5/8" x 23-9/16" (.64cm x 11.8cm x 60.2cm)

SECTION 2. WARRANTY

MAYTAG INTELLISENSE™ *Plus* DISHWASHER WARRANTY

Full Three Year Warranty

Any part which fails in normal home use after the date of original retail purchase, through the third year will be repaired or replaced free of charge.

Limited Five Year Warranty on Jetclean System and Solid State Controls

Any parts of the Jetclean system including the complete power module assembly, center spray nozzle, wash process sensor, spray arms, top wash arm hose, motor, AND—on Computer Touch Control Models only—any microprocessor and touch pad assemblies which fail in normal home use during the fourth through the fifth year from the date of original retail purchase, will be repaired or replaced free of charge for the part itself, with the owner paying all other costs, including labor.

Limited Five Year Warranty Against Rust

Should any of the parts listed below rust during the five year period starting from the date of original retail purchase, repair or replacement will be made free of charge during the first year. After the third and through the fifth year, repair or replacement will be made free of charge for the part itself, with the owner paying all other costs, including labor. Parts covered by this warranty are the exterior cabinet and front panels of convertible models; the exterior front panels of built-in models, and Nylon coated racks (available on select models).

FULL LIFETIME Warranty Against Leaks on Dishwasher Tub and Door Liner

Should a water leak develop in the tub or door liner in normal home use starting from the date of original retail purchase through the life of the dishwasher, repair or replacement of the tub and/or door liner will be made **FREE OF CHARGE**.

These full warranties and the limited warranties apply when the appliance is located in the United States or Canada. Appliances located elsewhere are covered by the limited warranties only, which include parts which fail during the first year.

Canadian Residents

This warranty covers only those appliances installed in Canada that have been listed with Canadian Standards Association unless the appliances are brought into Canada due to transfer of residence from the United States to Canada.

This Warranty gives you specific legal rights, and you may also have other rights which vary from state to state.

TO RECEIVE WARRANTY SERVICE

To locate an authorized service company in your area contact the Maytag dealer from whom your appliance was purchased; or call Maytag Customer Service. Should you not receive satisfactory warranty service, call or write:

Maytag Customer Service
240 Edwards St. S.E.
Cleveland, TN 37311
US 1-800-688-9900
CANADA 1-800-688-2002

When contacting Maytag Customer Service be sure to provide the model and serial number of your appliance, the name and address of the dealer from whom you purchased the appliance and the date of purchase.

Should you still have a problem, write to: Major Appliance Consumer Action Panel, 20 North Wacker Drive, Chicago, Illinois 60606. MACAP is an industry sponsored but independent group of consumer experts who receive and act on complaints from appliance owners.

NOTE: When writing about an unsolved service problem, please include the following information:

- (a) Your name, address and telephone number;
- (b) Model number and serial number (found on the upper left corner of the tub opening) of your appliance;
- (c) Name and address of your dealer and date the appliance was bought;
- (d) A clear description of the problem you are having;
- (e) Water hardness, detergent brand and amount, water temperature, and cycle used.

SECTION 3. CONTROL PANEL

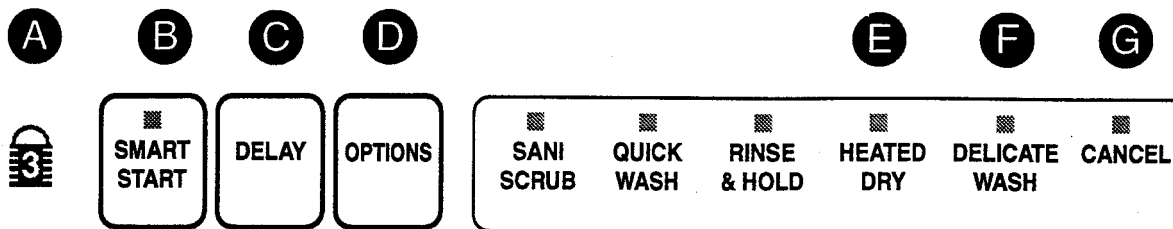

FEATURES

A. CHILD-LOCK

This key will activate a control lockout feature. All keys will remain inactive till the control lock is de-selected. To activate, press the key 3 times within 3 seconds. LOCKED will be displayed in the display area. To deactivate, press the key 3 times within 3 seconds.

B. SMART START

This key will activate the smart cycle. The indicator on the pad will light and a tone will sound when the pad is pressed. By using a variety of sensors the dishwasher will judge the water temperature, soil level and detergent, as well as the wash arm speed and rotation. It then develops an optimum cycle based on the information gathered. Continuously throughout the cycle the dishwasher will check the conditions. **Note: The consumer may notice the time display will change (either up or down) as the unit adjusts to the conditions.** This is normal operation.

When Smart Start is selected, all other selected cycles are cancelled. However, the Smart Start key must be selected before the end of the first fill. WASH & Wash Droplets will be displayed in the display area at the beginning of the cycle.

CYCLE SETTING	PRE-WASHES	MAIN WASHES	RINSES	FILLS	WATER USAGE
NO SOIL	0	1	2	3	3
LITE	1	1	2	4	7
LITE-PLUS	1	1	2	4	7
NORMAL	2	1	2	5	9
HEAVY	3	1	2	6	11

C. DELAY

This key will activate the delay mode. When pressed, 10 minutes will be displayed. Delay time can be increased by 10 minute increments with each touch of the key pad. It will increase to 60 minutes and continue to increase in one hour increments until 12 hours is displayed. To cancel, press the Delay key pad again. The dishwasher will automatically start as soon as delay time ends.

D. OPTIONS

This key will display six additional pads for a minimum of 30 seconds, when depressed (SANI SCRUB, QUICK WASH, RINSE & HOLD, HEATED DRY, DELICATE WASH and CANCEL.)

CYCLE SETTING	SEQUENCE	APPROX. CYCLE TIME	WATER USAGE
RINSE & HOLD	RINSE	6 Minutes	2 Gallons
QUICK WASH	WASH and 2 RINSES DRY	17 Minutes 35 Minutes (Optional)*	5 Gallons
SANI SCRUB	PRE-WASH 2 RINSES MAIN WASH 2 RINSES DRY	75 Minutes 35 Minutes 110 Minutes + Heating Delay**	11 Gallons

*Occurs if HEATED DRY is selected.

**The FINAL RINSE is heated to approximately 150°F. The time required will vary depending on the water temperature at beginning of the rinse.

E. HEATED DRY

This key will activate the heating element during the Dry cycle. When depressed, HEATED DRY will display in the display area. If depressed again, the element will be deactivated and only the blower will operate during the Dry cycle. If activated in the Smart Start cycle, the control board will sense the water temperature of the last rinse cycle and lengthen the heater on appropriately.

F. DELICATE WASH

This key will activate the Delicate wash mode. To activate, select another cycle (Smart Start, Quick Wash or Sani Scrub) then depress this key pad. Any cycle, including Smart Start, can become a gentle wash and dry cycle for china and crystal. This wash provides a reduced water velocity during washes and rinses by reducing the water fill by one quart. To accomplish this, the fill time is reduced to 70 seconds.

G. CANCEL

Pressing this key once will cancel any cycle before it is finished. The unit will drain, if needed then shut off. Pressing the key twice will turn off all backlighting and VFD displays.

VACUUM FLUORESCENT DISPLAY



***** CYCLE PROGRESSION INDICATORS *****

WASH

The estimated cycle time remaining for the wash portion of each cycle will be displayed in minutes. The Wash symbols will display during the fill portion and alternate to have the appearance of wash action after the motor has started.

RINSE	The estimated cycle time remaining for the rinse portion of each cycle will be displayed in minutes. The Rinse symbols will display during the fill portion and alternate to have the appearance of rinse action to increase in one hour increments until 12 hours is displayed.
DRY	The estimated cycle time remaining for the dry portion of the cycle will be displayed in minutes. The oscillating fan and red squiggles will be displayed in the VFD during heated dry, no red squiggles if heated dry is not selected. The fan blades will be alternated to give appearance of fan blowing when blower is on. The fan blades will remain motionless when the blower is not on.
CLEAN DRY	When the wash cycle is over CLEAN will be displayed in the VFD.
SPECIAL INDICATORS	
BLOCKED DRAIN	A restriction is indicated in the dishwasher drainage system.
BLOCKED WASH ARM	An indication something may be blocking the lower spray arm or restricting the center spray nozzle.
CLEAN	Displays at the end of a complete wash cycle. Will remain lit until the door has been unlatched for over 30 seconds.
DELAY	Displays when the Delay key pad is pressed.
DELICATE WASH	Displays when this option has been chosen with any wash cycle.
HEATED DRY	Displays if Heated Dry is selected.
HEATING	Displays when the water temperature is low and heating element is on during washing or rinsing portions of the cycle. Is NOT lit during the Dry cycle.
LOCKED	Displays when the Child Lock has been activated.
LOW RINSE AID	Indicates rinse aid level in reservoir is low. Displays at the end of the cycle as a reminder to add more rinse aid to the dispenser in the door. Will shut off after the door is opened.

PF

Indicates a power failure occurred. Any option selected before the power failure will need to be reselected. Otherwise the dishwasher will continue the cycle it was in at the time of the failure.

RINSED

Displays after a Rinse & Hold cycle.

WASH ARM

Indicates a possible foaming or starvation of the pump. Dishwasher will fill and drain to correct condition, if corrected, unit will finish wash cycle and not display CLEAN light.

SECTION 4. ELECTRICAL-MECHANICAL TROUBLESHOOTING

The dishwasher is controlled through the microprocessor board in conjunction with a transformer, board mounted relays, and sensor cluster mounted in the pump housing. The transformer provides the necessary voltage(s) to the microprocessor board and the sensors. The board mounted relays function as switches to give the microprocessor board control of the individual components (motor, heater, detergent dispenser, water valve, blower and rinse dispenser).

The sensor cluster consists of a turbidity sensor, a conductivity sensor, a wash arm rotation sensor and a temperature sensor. During the Smart Start cycle the control board communicates with the sensor cluster to monitor dishwasher performance and selects appropriate cycles to achieve optimum washing performance.

FIELD SERVICE TESTS

The microprocessor board incorporates three test display modes to aid the servicer in diagnosing any problems with the dishwasher. The tests comprise of the ERROR FAULT CODE listing, MANUAL FUNCTION test and the FUNCTIONAL test.

INITIAL KEY PAD SEQUENCE

All of the following test modes are started by pressing the following **Initial Sequence** of key pads followed by specific key pads that start the selected test:

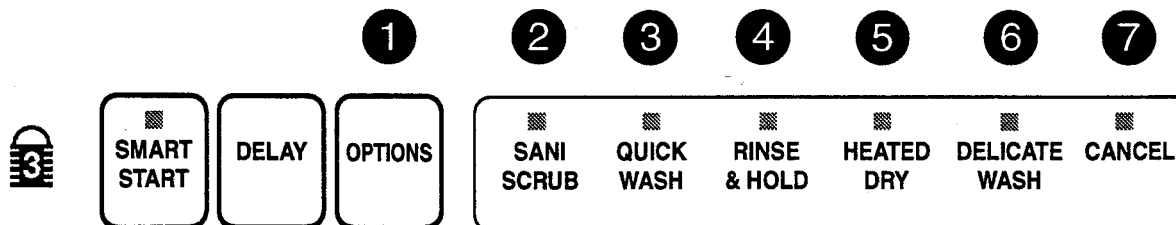

[Next key pad depressed determines selected test mode. To end any of the following test modes, press the **CANCEL** key pad.]

ERROR FAULT CODE DISPLAY

This mode should be run prior to performing any other test modes or tests.

To start, press the *initial sequence* of keys, press **Options** then **Sani Scrub**. The function of this display mode is to list all fault codes that are present. With a list of the fault codes displayed, the servicer can now determine which individual function needs further testing.

The following is the ERROR FAULT CODE listing of potential codes which may display. When the display begins, 00 will display to indicate the beginning of the display mode.

Each fault code will be shown in alpha/numeric order and displayed for 2 seconds before displaying the remaining codes. The display will continue to repeat the code displays, till **Cancel** is depressed. (NOTE: When CANCEL is depressed, all codes are cleared from memory.)

CODES	FAULT TYPE	DESCRIPTION	TROUBLESHOOTING
00	Beginning of Error Display Mode	If only this symbol is displayed, the controller did not detect any errors.	None required, all is working properly.
F0	Control Board Error	An error with the controller has been sensed.	Control board door circuit does not appear to be operating properly, check control board.
F1	Motor Fault - motor current not changing	An error with the motor has been sensed.	Check wiring to motor from control board. Check for bad motor.
F2	Heater Fault - heater current not changing	An error with the heater has been sensed.	Check wiring to heater from control board. Check for bad heater, open high limit thermostat.
F3	High Current Error	An error has been sensed with the electrical current within the machine. The current is higher than normal.	This error is probably caused by the heater or motor being energized when they should not be. This could be due to faulty wiring (shorts) or a welded relay. This error could also be caused by line current surges seen by the current sensor.
F4	Detergent Fault - no conductivity change	No detergent has been detected in the main wash for 10 cycles. Either the consumer is not using detergent in the main wash or an error with the detergent cup may be present.	Check that consumer is using detergent in the main cup. Check the detergent cup wax motor and the wiring to and from the wax motor.
F5	Rinse Aid Fault	An error with the rinse aid dispensing has been sensed. This may be shown after the RS functional test if the Rinse Aid does not go from full to low.	Check connector from control board to rinse aid dispenser. Check for bad rinse aid dispenser.
F7	Turbidity Sensor Fault	An error with the turbidity sensor has been sensed.	A bad turbidity sensor reading has occurred. Check connections to Wash Process Sensor from control board. Also check for properly operating Wash Process Sensor. Finally check control board.
F8	Wash Arm Fault	An error with the wash arm rotation system has been sensed.	A bad washer arm reading has occurred. Check connections to Wash Process Sensor from control board. Check pump for the correct back wash arms and alignment of sensor. Check for properly operating wash process sensor. Finally check control board.
F9	Thermistor Fault	An error with the thermistor has been sensed.	A bad temperature sensor reading has occurred. Check connections to Wash Process Sensor from control board. Also check for properly operating Wash Process Sensor. Finally check control board.
1F0	Washer Arm Sensor Error	An error has been detected sensing the wash arm rotation. Five cycles in a row have concluded with a blocked wash arm present. A reset of the fault codes is necessary to clear this fault.	Check magnet in back rinse arms in pump. Check for operational sensor cluster. Check user loading pattern.
1F1	Conductivity Fault	An error with the conductivity sensor has been sensed.	A bad conductivity sensor reading has occurred. Check connections to Wash Process Sensor from control board. Also check for properly operating Wash Process Sensor. Finally check control board.
1F2	High Limit Thermostat	A temperature above 155° has been detected and the heater will still turn on.	Check the high limit thermostat for operation.
1F3	Communication Problem	Control and sensor pack communications is not operating properly.	A bad communication to the sensor has occurred. Check connections to Wash Process Sensor from control board. Also check for properly operating Wash Process Sensor. Finally check control board.
1F4	Cold Water Problem	Water below 90° is being detected at the temperature sensor of the dishwasher from the inlet valve.	Check with the consumer to make sure the inlet water temperature is near 120° F. If necessary suggest that the kitchen faucet be started before the cycle is to get hotter water to the dishwasher from the start.
1F5	Current Sensor Bad	The controller has sensed that the current sensor is not changing with any loads in the machine.	A bad current sensor on the control board has been detected. Check to make sure connections to board are correct and the black power line is properly connected to the ¼" spade terminal on the board.

MANUAL TEST MODE:

This test will enable the servicer to manually turn on individual functions. Such as the motor, water valve, detergent dispenser, rinse aid dispenser, heating element and blower.

To start, press the *initial sequence* of key pads, press **Options** then **Delay**.

After this mode is entered the following table indicates which keys will start the relays. The display will show 1 minute and keys will toggle individual functions ON and OFF as follows:

KEY PAD	RELAY ENERGIZED
SANI SCRUB	Motor
SMART START	Water Valve (Fill)
QUICK CYCLE	Detergent Dispenser
RINSE & HOLD	Rinse Aid Dispenser
HEATED DRY	Heating Element
DELICATE WASH	Blower Motor

The machine will shut off 59 seconds after the last actuation of a key.

When the test is finished and/or the repair completed, run the ERROR FAULT CODE display listing again. This confirms whether any other part is malfunctioning and the repair is completed.

FUNCTION TEST MODE:

This is a longer test mode, lasting 14 minutes and 30 seconds; the display will show 14 minutes. In this mode the dishwasher is allowed to fill, wash, drain and activate the dispensers. Upon completion of this test, the unit will have checked the motor, heater and sensor circuits. The unit will then display fault codes at the end of the test. (NOTE: Fault codes F3, F4, 1F0, 1F2 and 1F4 will not be displayed in this test mode.)

The servicer must still verify the operation of the blower, water valve, dispensers, VFD segments and LED displays during the test.

To start, press the *initial sequence* of key pads, press **Delay**, **Smart Start** and **Cancel**.

The following is a scenario of the functions to be displayed and their time sequence.

Test Cycle:

14 minutes in the display (14 minutes and 30 second test)
5 second pause, all LED's and VFD on
"LOW RINSE AID" segments should be on entire cycle
5 seconds of blower, "DELAY", "HOURS" turned on in VFD
100 seconds fill, "WASH", "HEATED DRY", segments in VFD
200 seconds motor, "WASH", "HEATED DRY", Wash droplets active
100 seconds drain, conditioner, "DRAIN", "HEATED DRY" segments turned on
110 seconds fill, "RINSE", "DELICATE WASH", "HEATED DRY" segments on
180 seconds of motor, detergent, heater, "RINSE", "HEATED DRY", "HEATING"
segments Rinse droplets
100 seconds drain, rinse conditioner, "BLOCKED WASH ARM", "HEATED DRY"
segments on
50 seconds heater, blower, "DRY", blower fan, "CLEAN" segments on

When test is finished and/or the repair completed, run the ERROR FAULT CODE display listing again. This confirms whether any other part is malfunctioning and the service call is complete.

ELECTRICAL TROUBLESHOOTING: MODEL DWU9961

[For additional troubleshooting and other complaints refer to service manual part number 16000374, section 2.]

WILL NOT START OR PROGRAM

With the door unlatched, the key pads cannot be activated. When the door is latched, depress any cycle key pad. A display of minutes will appear in the window. If not, check the following:

Varistor If visual inspection shows damage, transformer should also be checked. If transformer checks okay, the VARISTOR only should be replaced.

Transformer Check primary coil, BLACK to WHITE and secondary coils RD to RD, BU to YL, YL to BU, BU to BU and WH to WH. If no continuity on any check, replace transformer. Voltage checks are as follows:

WIRE 1	WIRE 2	VOLTAGE
Black	Black	120 VAC
Blue	Blue	4.1 VAC
Blue	Yellow	2.0 VAC
Red	Red	5.9 VAC
White	White	19.2 VAC

Door Switch With door switch activated, check for continuity across the switch terminals. No continuity, replace switch.

Microprocessor Check for 120 VAC input voltage to the board. Check BLACK wire to the WHITE wire on PS1 terminal connector. No voltage, check BLACK and WHITE wire harnesses from door switches. If voltage is correct, check terminal connectors to microprocessor board for good contact with board. Voltage checks for the input voltages to the board are as follows.

FUNCTION	WIRE 1	WIRE 2	VOLTAGE
Power Supply	PS2 - 1 (White)	PS2 - 2 (White)	19.2 VAC
Backlighting - key pads	PS4 - 1 (Red)	PS4 - 2 (Red)	5.9 VAC
Backlighting - key pads	PS4 - 1 (White)	PS3 - 3 (#12)	25 VDC (Note: DC voltage)
VFD Display	PS3 - 7 (Blue)	PS3 - 9 (Blue)	4.1 VAC
VFD Display	PS3 - 7 (Blue)	PS3 - 8 (Yellow)	2.0 VAC
VFD Display	PS3 - 8 (Yellow)	PS3 - 9 (Blue)	2.0 VAC

WILL NOT FILL

Make sure unit is programmed. See "WILL NOT START OR PROGRAM".

Float Switch Check for continuity between float switch terminals (Blue to Blue). No continuity, replace switch.

Water Valve Check coil (Blue to White) terminals for continuity. No continuity, replace the water valve. If continuity present, check valve inlet for debris.

Microprocessor Check microprocessor board wire harness connector at microprocessor terminals PS1 - 1 to PS1 - 3. Should show continuity at the harness connection. Check output voltage of board terminals PS1 - 1 to PS1 - 3, should see approximately 120 VAC present. If not, replace the microprocessor board.

OVERFLOWS

Float Switch With float in raised position check continuity across switch terminals. Should show NO continuity. If continuity found, replace the float switch.

Water Valve With no continuity across the float switch terminals, examine the water valve diaphragm for blocked bleeder holes. Clean and return diaphragm to the valve. Change valve if necessary.

Microprocessor Check for output voltage from the microprocessor board at terminals PS1-1 and PS1-3. Should not see any voltage present. If voltage present, replace microprocessor board.

WILL NOT DRAIN

Drive Motor Perform continuity check of the motor windings. Check DRAIN start winding (Blue to Red), WASH start winding (Blue to Gray) and the MAIN winding (Blue to Yellow). If no continuity found, replace pump and motor assembly. If continuity present, hook up motor test cord, see Section 1 of Electrical Testing Equipment in service manual 16000374. If motor will not operate with test cord, check for obstructions in the pump.

Start Relay Perform continuity check for the start relay. With the Yellow terminal in the UP position, check for continuity across the Yellow and White terminals. No continuity should be present across the White and Pink terminals. Rotate the switch 180° and check across White and Pink terminals. They should now show continuity. If continuity checks do not match the aforementioned descriptions, replace the Start Relay.

Microprocessor Board Check the Motor Direction Relay on the board by performing a continuity check across terminals Pink to Red and Pink to Gray. If continuity is not found in either circuit, replace the microprocessor board. (Note: Only one circuit can be activated at a time.)

WILL NOT DRY

Microprocessor Perform continuity check across PS1- 1 terminal of connector and the Orange wire terminal. Should show continuity across the wire harnesses. Check for board voltage output across the corresponding microprocessor board terminals, for Heating Element. (See Diagnostic Chart, page 4-9.) Should show approximately 120 VAC when the heater relay is activated. If no voltage is present, replace microprocessor.

POOR WASHABILITY

If the consumer is not satisfied with the cycle selected by the computer, the servicer can "Bump" up the cycle normally selected by the computer during the Smart Start. This feature is called "Intelli-Bump" and is activated by pressing **OPTIONS - CANCEL - CANCEL - SANI SCRUB**. To "Bump" up to another cycle, press the SANI SCRUB key pad again. The VFD will display "A0" initially. Each time Sani Scrub is depressed the unit will bump up and display A1, A2, A3, A4. After A4 the unit will reset to original factory preset mode.

[For additional troubleshooting of other complaints refer to service manual part number 16000374, Section 2.]

DIAGNOSTIC CHART

Following is a chart listing the output and input voltages for the microprocessor board along with their function. This chart should prove beneficial in checking the sensors and other related components. To perform continuity checks of the individual circuits away from the microprocessor, you must remove power to the dishwasher.

Note: When the door latch opens, the microprocessor shuts off all relays. Thus, no continuity checks through the board can be made.

FUNCTION	BOARD TERMINAL/WIRE	BOARD TERMINAL/WIRE	VOLTAGE -APPROX. (WHEN ACTIVATED)
Blower	PS1-1 (White)	PS1-2 (Purple)	120 VAC
Water Valve*	PS1-1 (White)	PS1-3 (Blue)	120 VAC
Detergent Dispenser	PS1-1 (White)	PS1-4 (Blue)	120 VAC
Rinse Aid Dispenser	PS1-1 (White)	PS1-5 (Pink)	120 VAC
Heating Element	PS1-1 (White)	Orange Wire	120 VAC
Sensor Cluster (Input Voltage) (Output Voltage)	PS3-3 (#12) PS3-3 (#12)	PS3-6 (#21) PS3-2 (#22)	15 VDC 15 VDC
Rinse Aid Sensor (Input) (Output)	PS3-3 (#12) PS3-3 (#12)	PS3-5 (#11) PS3-1 (#13)	15 VDC 0 VDC (Empty) 7 VDC (Full)
Motor (Main Winding)	PS1-1 (White)	Blue Wire	120 VAC
Motor (Wash Start Winding)**	PS1-1 (White)	Gray Wire	120 VAC
Motor (Drain Start Winding)**	PS1-1 (White)	Red Wire	120 VAC

*Float switch must be closed.

**Start windings only. Note: Brief voltage present till start relay drops out of circuit.

SECTION 5. SERVICE PROCEDURES

The following procedures outline those procedures which are unique to the IntelliSense™ dishwasher. Otherwise, the service procedures are the same as those outlined in the "07" series dishwasher service manual, part number 16000374.

CAUTION! There can be risk of injury or electrical shock while performing services or repairs. Injury or electrical shock can be serious or even fatal.

MICROPROCESSOR BOARD

The microprocessor board is a one piece circuit board assembly. The control relays are mounted on the backside of the board as opposed to being mounted separately on earlier models.

To Remove:

1. Disconnect the power supply to the dishwasher.
2. Open the dishwasher door and remove the seven TORX screws securing the door liner to the door assembly.
3. Remove or relocate the inner door liner to gain access to the control barrier inside the door assembly.
4. Remove the control barrier by depressing the left retainer tab on the barrier. Then lift the barrier to gain access to the microprocessor board assembly.
5. Disconnect the wire harness connectors to the board and the miscellaneous wires attached. Note the wire locations for reattachment to the replacement board.

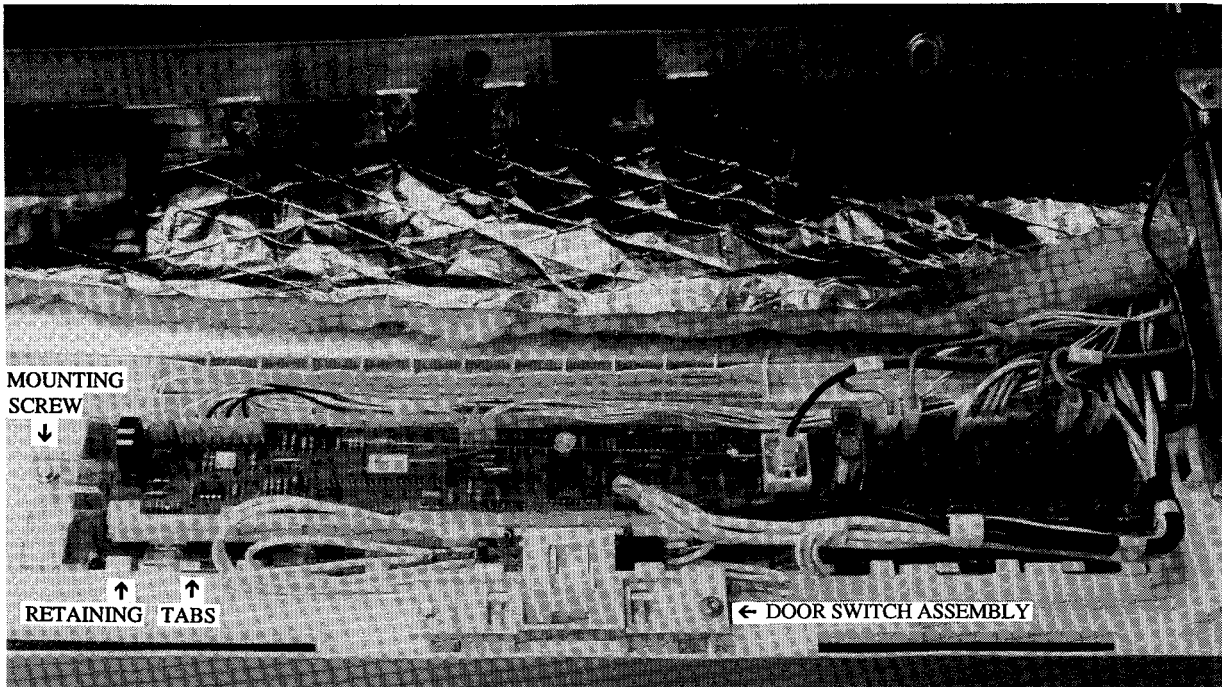

CONTROL PANEL AREA EXPOSED

6. Remove and relocate the door latch switch assembly.
7. Remove the hex head screw securing the microprocessor board assembly to the control panel.
8. Slide the microprocessor board assembly to the left, toward the direction of the mounting screw location. Disengage the retainer tabs from the control board tabs. Then lift the board assembly off of the control panel.
9. To reassemble, reverse the aforementioned procedure.

TRANSFORMER

The transformer is used to provide the proper operating voltages to the microprocessor board. The transformer is mounted to the tub support wall behind the blower assembly. Removal of the blower assembly is necessary to service the transformer.

To Remove:

1. Disconnect the power supply to the dishwasher.
2. Remove the access and toe panels of the dishwasher.

3. Remove the hex screw securing the blower assembly to the tub support ceiling. Move the blower assembly aside to access the transformer mounting screws and wiring harnesses.

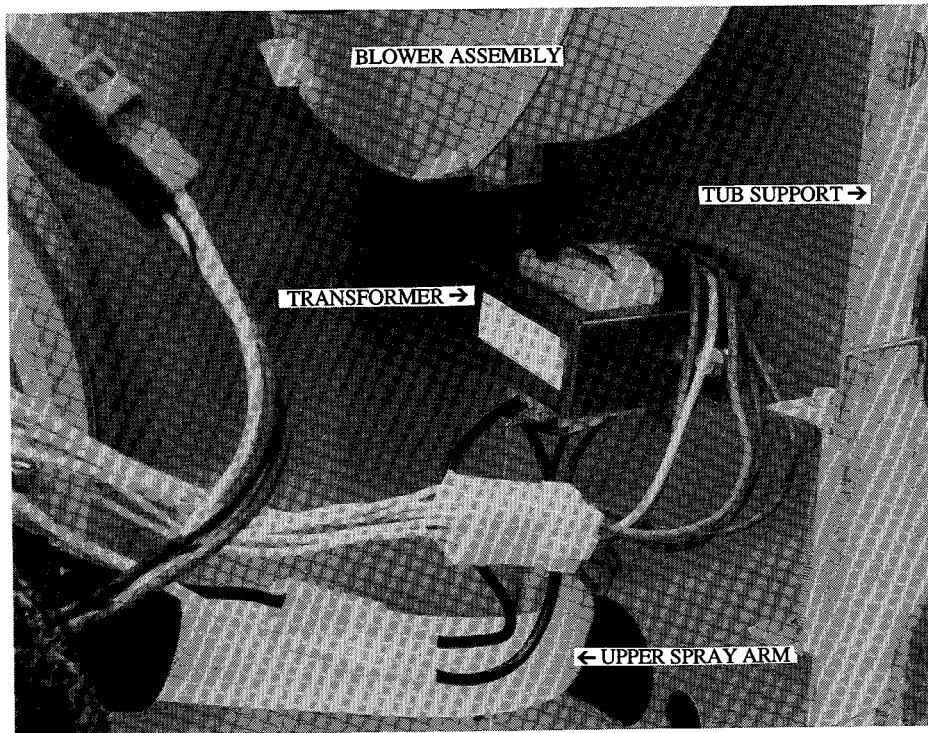

4. Disconnect the two wiring harnesses from the transformer. (Note: Earlier units have a short harness jumper attached to the transformer to aid assemblers. Wire harnesses have since been lengthened to compensate. **DO NOT DISPOSE OF THIS HARNESS WITH THE TRANSFORMER.** This harness will be required to attach main wire harness to replacement transformer.)

To check the transformer, see ELECTRICAL TROUBLESHOOTING - "Will Not Program."

SENSOR CLUSTER

The sensor cluster is equipped with four sensors in the pump housing. The sensor cluster consists of a turbidity sensor, a conductivity sensor, a wash arm rotation sensor and a temperature sensor. These sensors inform the control board of the conditions present in the dishwasher. From this information, the control board will determine the number of washes and rinses required to obtain maximum washability.

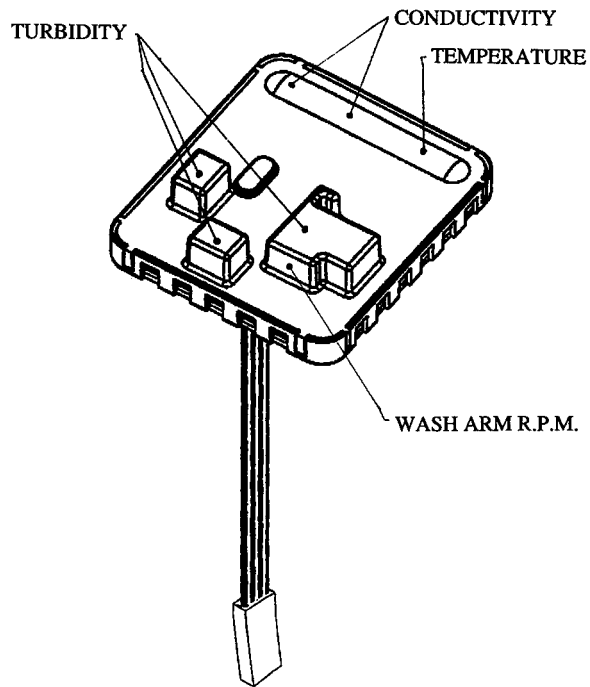

The sensor cluster is mounted inside of the power module assembly, through the lower half of the pump housing. Removal of the pump and motor assembly is necessary to service this area.

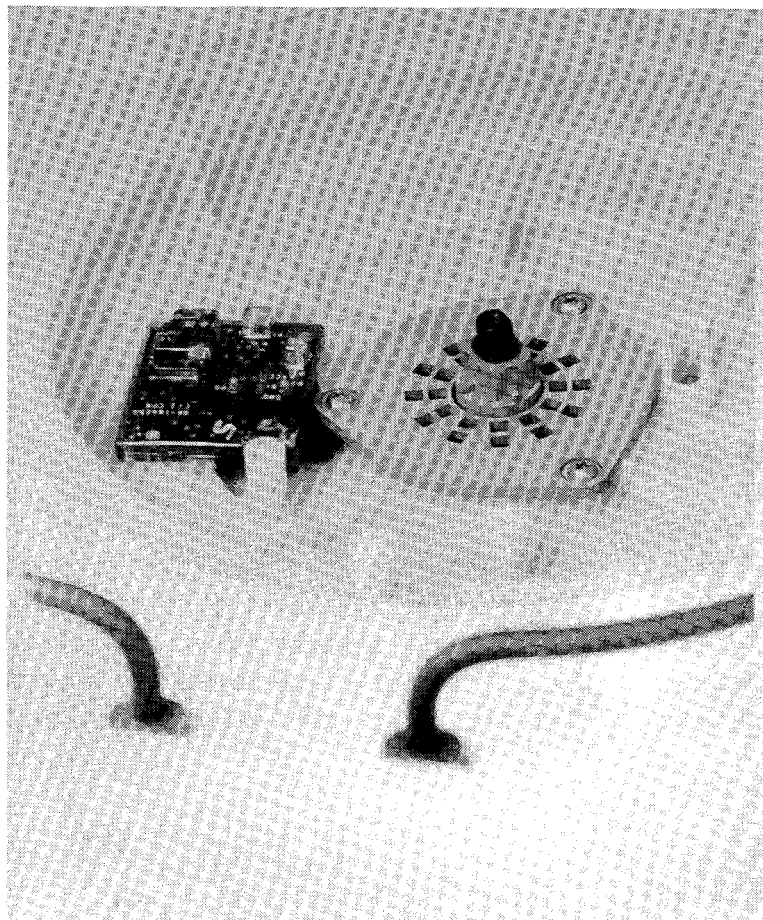

To Remove:

1. Disconnect power supply to the dishwasher.
2. Remove the access and toe panels to gain access to the pump locking ring, pump module wiring harnesses.
3. Disconnect wiring harnesses to the motor and the sensor cluster. To disconnect the sensor harness connector, depress the center tab and separate the connectors. Remove the ground wire from the motor.

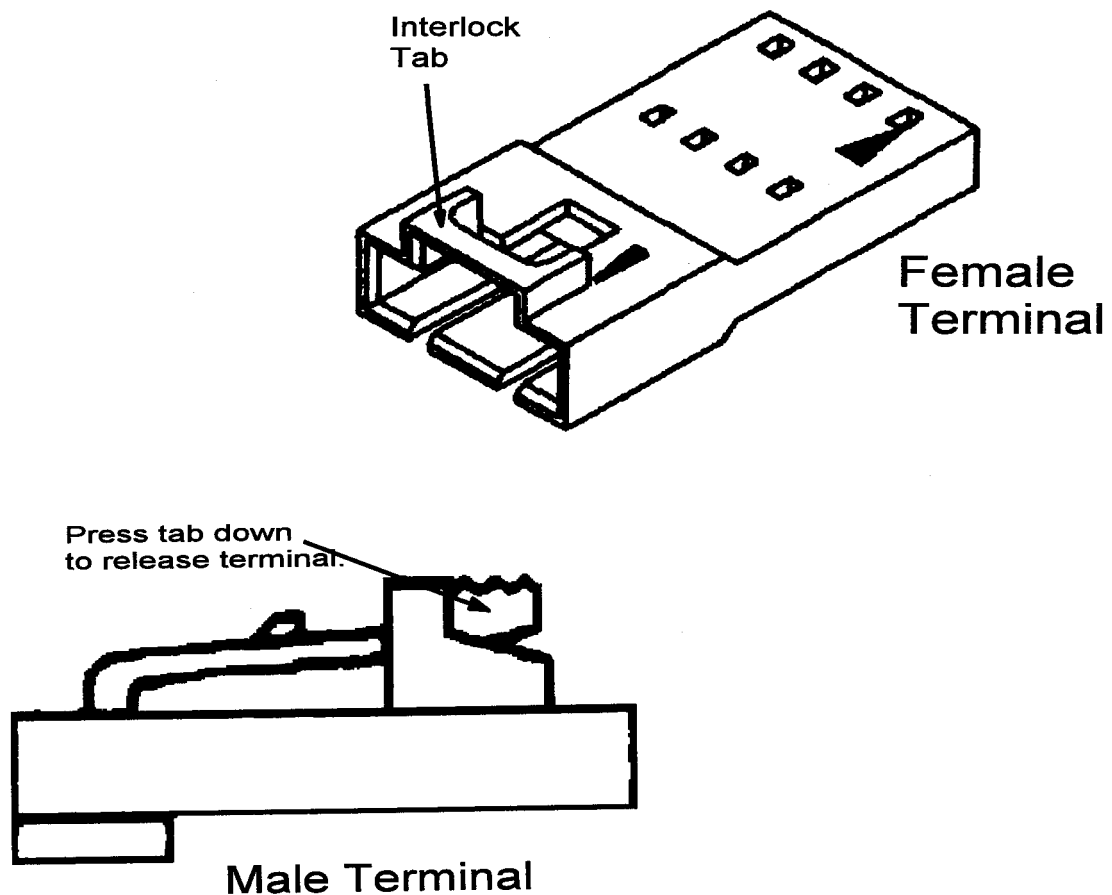

4. Disconnect the drain hose and upper spray arm hose. Have a towel handy in case of water spillage.
5. Loosen the locking ring from the pump and motor assembly.
6. Open the door and remove the lower rack.
7. Remove the pump module assembly by lifting upward.

8. Disassemble the pump module by removing the center spray nozzle, lower spray arm, strainer, pump filter, rinse arm assembly with magnets, wash arm support, recirculating impeller cover, recirculating impeller, lower pump cover and filter base. (For information on how to disassemble the pump module, see Maytag dishwasher service manual, part number 16000374.)

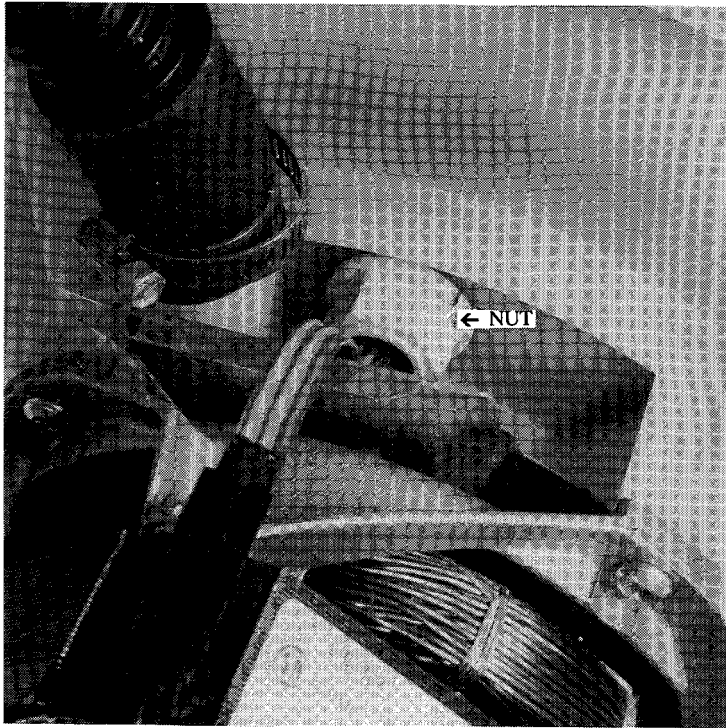

9. Remove the nut securing the sensor cluster to the pump housing. Then lift the sensor cluster from the housing.

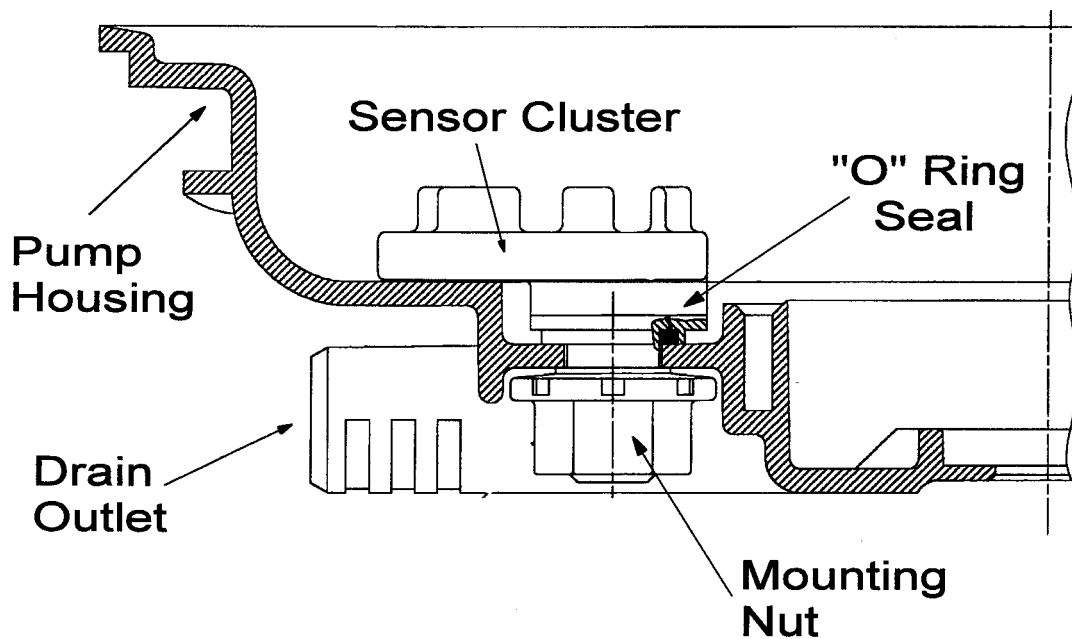

10. Examine the O-ring recessed into the sensor cluster for good seal integrity, replace if necessary.
11. To reassemble, reverse the aforementioned procedure. **Note: The sensor cluster has an alignment rib on the underside to aid in positioning.**

RINSE AID RESERVOIR WITH SENSOR

The rinse aid reservoir incorporates a sensor mechanism to inform the control board when the rinse aid level in the reservoir is low. This is done by means of a floating magnet within the reservoir. The reservoir is attached to the inside of the inner door panel. Replacement of the reservoir with sensor is necessary when the sensor failures occur.

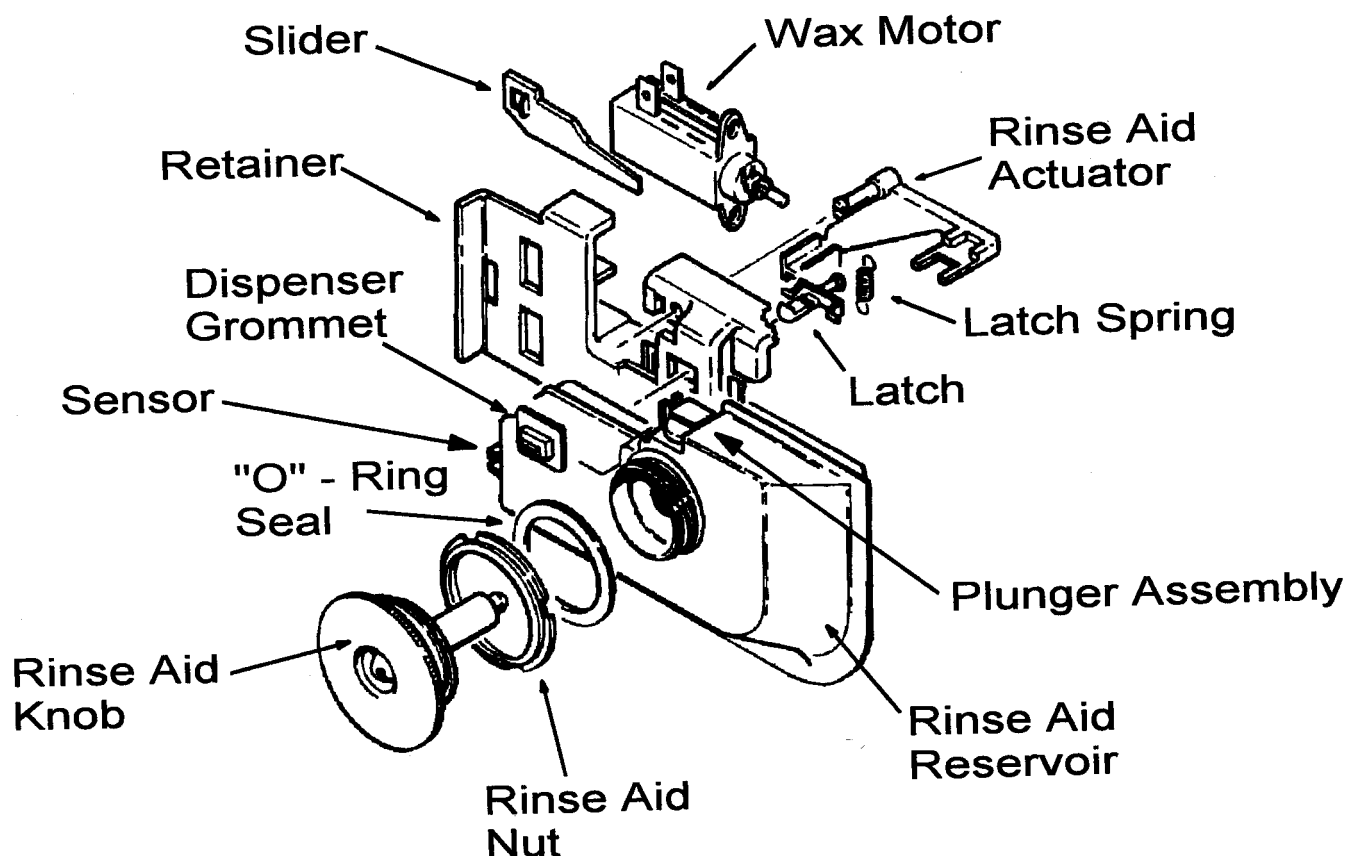

To Remove:

1. Disconnect power supply to the dishwasher.

2. Remove the seven inner door panel screws and separate the inner door panel from the door assembly.
3. Disconnect the sensor harness to reservoir. To disconnect connector for the sensor harness, depress the center tab and separate the connectors.

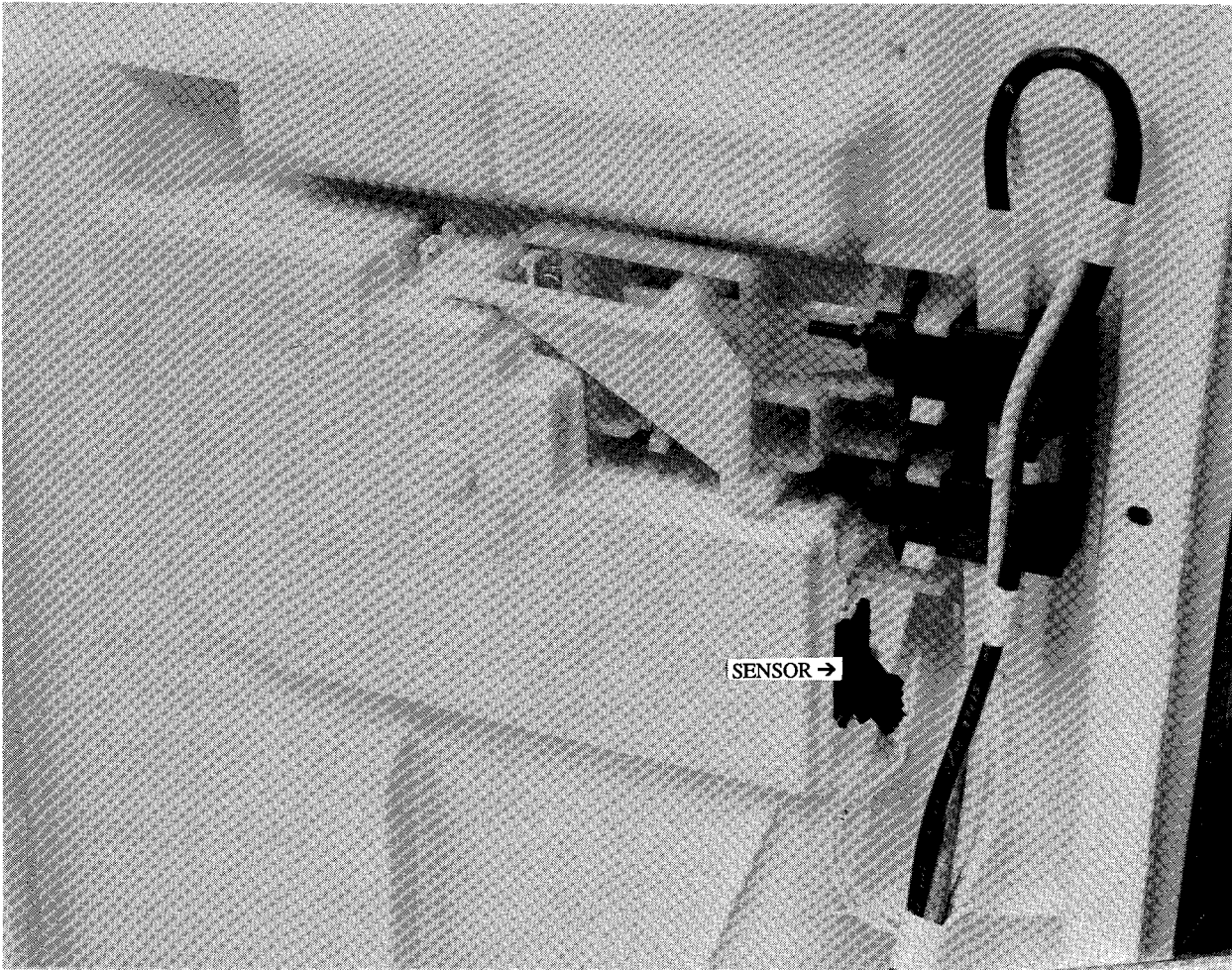

4. Disengage the rinse aid actuator from the plunger.
5. On the face of the inner door, remove the rinse aid cap and nut.
6. Lift off the reservoir from the inner door panel for any damage. Replace if necessary.
7. To reassemble, reverse the procedure.

SECTION 6. SCHEMATIC

An Electrical Schematic is packed in every unit. It is located inside the access panel. Always remember to return the schematic to it's original location for future use.

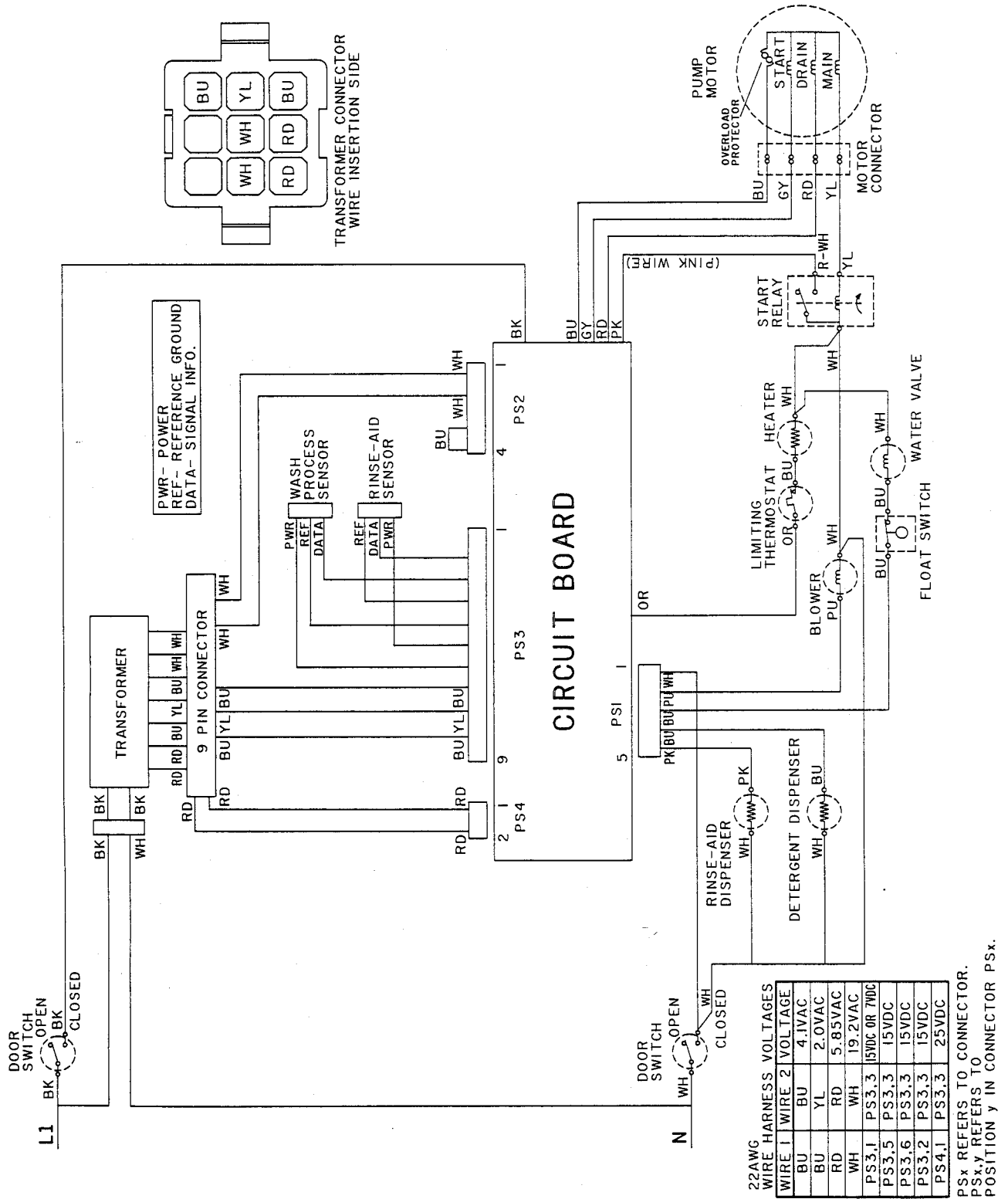

REQUIRED KEY SEQUENCE TO ENTER FUNCTIONAL TEST MODE:

Key	Board Reaction	LED "ON" above Switch	Audio Signal
Option Key	Backlighting on	NO	YES
Soni Scrub Cycle	Soni scrub cycle	YES	YES
Quick Cycle	Quick wash cycle	YES	YES
Rinse and Hold	Rinse cycle	NO	NO
Heated Dry	NONE	YES/NO	YES
Delicate Wash	Delicate Wash ON/OFF	NO	NO
Dr Key	Dr Key	NO	NO
Delay Key	Delay Key	YES	YES
Start Key	Start functional test	NO	NO

A) Total test time 15 minutes or less
 B) Test sequence will turn on the segments of the VFD
 C) Test Cycle:

15 minutes in the display
 LED's and VFD on
 5 second phase in LED's and VFD on
 5 seconds of blower "DELAY", "HOURS" turned on in VFD
 100 seconds fill, "WASH", "HEATED DRY" segments in VFD
 200 seconds motor, "WASH", "HEATED DRY" segments active
 100 second drain, conditioner, "HEATED DRY" segments on
 110 second fill, "RINSE", "DELICATE WASH", "HEATED DRY" segments on
 180 seconds of motor, detergent, heater, "RINSE", "HEATED DRY",
 "HEATING" segments Rinse droplets, "BLOCKED WASH ARM", "HEATED DRY" segments
 50 seconds heater, blower, "DRY" blower fan, "CLEAN" segments on

D) Sensors to test

Turbidity:
 Conductivity:
 Temperature:
 Wash Arm Rotation:
 Rinse Aid Level:
 Current Sensor:
 Door Open:
 Done by control board
 Done by control board
 Done by control board
 Control board checks
 for low Rinse aid
 Done by control board
 Done by control board

E) Machine Items controller can test:

Heater
 Motor
 Blower
 Water
 Detergent Dispense
 Rinse Aid Dispense
 VFD segments
 LED's
 Fault Codes

REQUIRED KEY SEQUENCE TO ENTER MANUAL FUNCTION MODE:

Key	Board Reaction	LED "ON" above switch	Audio Signal
Option Key	Backlighting on	NO	YES
Soni Scrub Cycle	Soni scrub cycle	YES	YES
Quick Cycle	Quick wash cycle	YES	YES
Rinse and Hold	Rinse cycle	NO	NO
Heated Dry	none	YES/NO	YES
Delicate Wash	Delicate Wash ON/OFF	YES	YES
Dr Key	Dr Key	NO	NO
Options Key	none	NO	NO
Delay Key	Manual Function mode	NO	NO

After this mode is entered, the following table indicates which keys will start which relays. The display will show 2 minutes and the keys will toggle individual functions on and off as follows:

Key	Relay Energized
Soni Scrub	Motor
Quick Cycle	Detergent dispenser
Rinse and Hold	Rinse aid dispenser
Heated Dry	Heater
Delicate Wash	Blower

The machine will shut off 100 seconds after the last actuation of a key.

CODES	FAULT TYPE	DESCRIPTION	TROUBLESHOOTING
00	BEGINNING OF ERROR DISPLAY MODE.	IF ONLY THIS SYMBOL IS DISPLAYED THE CONTROLLER DID NOT DETECT ANY ERRORS.	NONE REQUIRED.
F0	CONTROL BOARD ERROR	AN ERROR WITH THE CONTROLLER HAS BEEN SENSED.	CONTROL BOARD DOOR CIRCUIT DOES NOT APPEAR TO BE OPERATING PROPERLY. CHECK CONTROL BOARD.
F1	MOTOR FAULT - MOTOR CURRENT NOT CHANGING	AN ERROR WITH THE MOTOR HAS BEEN SENSED.	CHECK WIRING TO MOTOR FROM CONTROL BOARD. CHECK FOR BAD MOTOR.
F2	HEATER FAULT - HEATER CURRENT NOT CHANGING	AN ERROR WITH THE HEATER HAS BEEN SENSED.	CHECK WIRING TO HEATER FROM CONTROL BOARD. CHECK FOR BAD HEATER. OPEN HIGH LIMIT THERMOSTAT.
F4	DETERGENT FAULT - NO CONDUCTIVITY CHANGE	NO DETERGENT HAS BEEN DETECTED IN THE MAIN WASH FOR 10 CYCLES. EITHER THE CONSUMER IS NOT USING DETERGENT IN THE MAIN WASH OR AN ERROR WITH THE DETERGENT CUP MAY BE PRESENT.	CHECK THAT CONSUMER IS USING DETERGENT IN THE MAIN CUP. CHECK THE DETERGENT CUP WAX MOTOR AND THE WIRING TO AND FROM THE WAX MOTOR.
F5	RINSE AID FAULT	AN ERROR WITH THE RINSE AID DISPENSING HAS BEEN SENSED. THIS MAY BE SHOWN AFTER THE RS FUNCTIONAL TEST IF THE RINSE AID DOES NOT GO FROM FULL TO LOW.	CHECK CONNECTOR FROM CONTROL BOARD TO RINSE DISPENSER. CHECK FOR BAD RINSE AID DISPENSER.
F7	TURBIDITY SENSOR FAULT	AN ERROR WITH THE TURBIDITY SENSOR HAS BEEN SENSED.	A BAD TURBIDITY SENSOR READING HAS OCCURRED. CHECK CONNECTIONS TO WASH PROCESS SENSOR FROM CONTROL BOARD. ALSO CHECK FOR PROPERLY OPERATING WASH PROCESS SENSOR. FINALLY, CHECK CONTROL BOARD.
F8	WASH ARM FAULT	AN ERROR WITH THE WASH ARM ROTATION SYSTEM (EITHER MAGNET OR HALL EFFECT DEVICE) HAS BEEN SENSED.	A BAD WASHER ARM READING HAS OCCURRED. CHECK CONNECTIONS TO WASH PROCESS SENSOR FROM CONTROL BOARD. CHECK PUMP FOR THE CORRECT BACK WASH ARM AND ALIGNMENT OF SENSOR. CHECK FOR PROPERLY OPERATING WASH PROCESS SENSOR. FINALLY, CHECK CONTROL BOARD.
F8	THERMISTOR FAULT	AN ERROR WITH THE THERMISTOR HAS BEEN SENSED	A BAD TEMPERATURE SENSOR READING HAS OCCURRED. CHECK CONNECTIONS TO WASH PROCESS SENSOR FROM CONTROL BOARD. ALSO CHECK FOR PROPERLY OPERATING WASH PROCESS SENSOR. FINALLY, CHECK CONTROL BOARD.
1F1	CONDUCTIVITY FAULT	AN ERROR WITH THE CONDUCTIVITY SENSOR HAS BEEN SENSED.	A BAD CONDUCTIVITY SENSOR READING HAS OCCURRED. CHECK CONNECTIONS TO WASH PROCESS SENSOR FROM CONTROL BOARD. ALSO CHECK FOR PROPERLY OPERATING WASH PROCESS SENSOR. FINALLY, CHECK CONTROL BOARD.
1F2	HIGH LIMIT THERMOSTAT	A TEMPERATURE ABOVE 155 HAS BEEN DETECTED AND THE HEATER WILL STILL TURN ON.	CHECK THE HIGH LIMIT THERMOSTAT FOR OPERATION.
1F3	COMMUNICATION PROBLEM	COMMUNICATIONS BETWEEN THE CONTROLLER AND SENSOR PACK ARE NOT OPERATING PROPERLY.	A BAD COMMUNICATION TO THE SENSOR HAS OCCURRED. CHECK CONNECTIONS TO WASH PROCESS SENSOR FROM CONTROL BOARD. ALSO CHECK FOR PROPERLY OPERATING WASH PROCESS SENSOR. FINALLY, CHECK CONTROL BOARD.
1F4	COLD WATER PROBLEM	WATER BELOW 90 DEGREES IS BEING DETECTED AT THE TEMPERATURE SENSOR OF THE DISHWASHER FROM THE INLET VALVE.	CHECK WITH THE CONSUMER TO MAKE SURE THE INLET WATER TEMPERATURE IS NEAR 120 F. IF NECESSARY SUGGEST THAT THE KITCHEN FAUCET BE STARTED BEFORE THE CYCLE TO GET HOTTER WATER TO THE DISHWASHER FROM THE START.
1F5	CURRENT SENSOR BAD	THE CONTROLLER HAS SENSED THAT THE CURRENT SENSOR IS NOT CHANGING WITH ANY LOADS IN THE MACHINE.	A BAD CURRENT SENSOR ON THE CONTROL BOARD HAS BEEN DETECTED. CHECK TO MAKE SURE CONNECTIONS TO BOARD ARE CORRECT, AND THAT THE BLACK POWER LINE IS PROPERLY CONNECTED TO THE 1/4" SPACE TERMINAL ON THE BOARD.
1F6	RELAY CURRENT FAILURE - SHOULD BE SEEN ONLY AT BOARD MANUF.	THIS FAILURE INDICATES THAT THE CURRENT SENSOR DID NOT READ A CHANGE IN LOADS DURING BOARD MANUF. FUNCTIONAL TEST WHILE THE FIRST RELAY WAS ACTUATED.	SHOWN ONLY IN BOARD MANUF. FUNCTIONAL TEST MODE. SHOULD NOT OCCUR IN MANUAL FUNCTION MODE OR FUNCTIONAL TEST MODE.
1F7	MODEL SWITCH FAILURE - SHOULD BE SEEN ONLY AT BOARD MANUF.	THIS FAILURE IS GIVEN IF THE MODEL SWITCH DOES NOT GET CHANGED FROM JA TO MAYTAG DURING THE BOARD MANUF. FUNCTIONAL TEST.	SHOWN ONLY IN BOARD MANUF. FUNCTIONAL TEST MODE. SHOULD NOT OCCUR IN MANUAL FUNCTION MODE OR FUNCTIONAL TEST MODE.

MAYTAG

Maytag Appliances Sales Company

Customer Service
240 Edwards St.
Cleveland, TN 37311