



*Dishwasher
DMT300 series training
Jan 2010*

Kitchen Solution Business Team

Agenda

- I. General Specification
 - a) Features and functions
 - b) Specification
- II. Hardware
 - a) Wiring diagram
 - b) Schematic
- III. Disassembly
- IV. Trouble Shooting
 - a) Error message
 - b) Trouble shooting flow
 - c) Error Trouble shooting
- V. Reference

General Specification



Main Features	<ul style="list-style-type: none">▪ Capacity: 14 place settings▪ Control panel design<ul style="list-style-type: none">- Front type + Button operation.▪ Dimension (W x D x H) : 23-7/8 x 24-3/4 x 33-7/8 inch (605 x 627 x 860 mm)
Sales Point	<ul style="list-style-type: none">▪ Flexible Style : Inclined Rack System, Height adjustable Upper Basket▪ Upgraded Kitchen : Pleasant kitchen environment, Simple & Modern design▪ Smart Control : Soil sensing Programming, ABS door system

Dishwasher Features

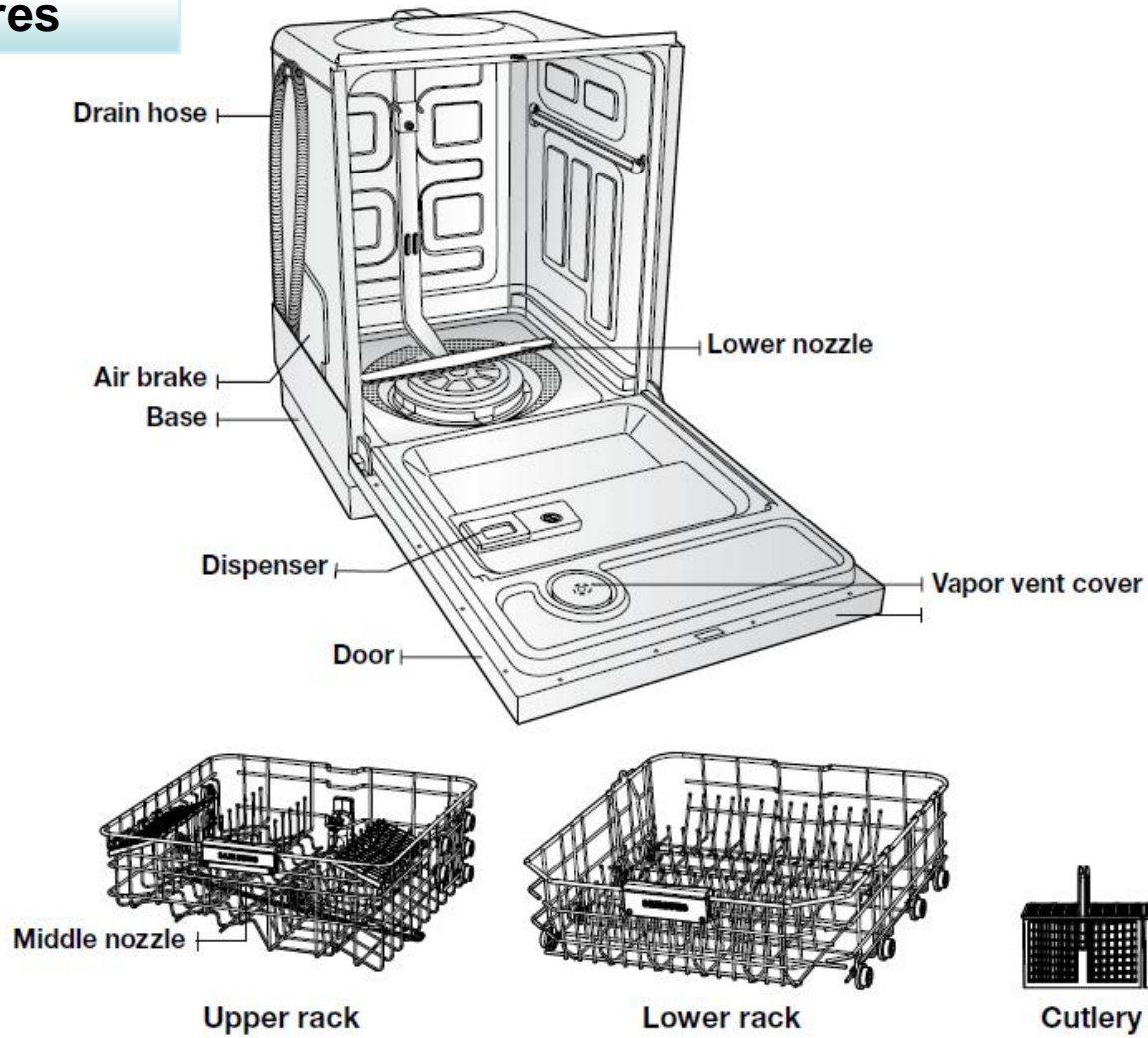

Control Panel

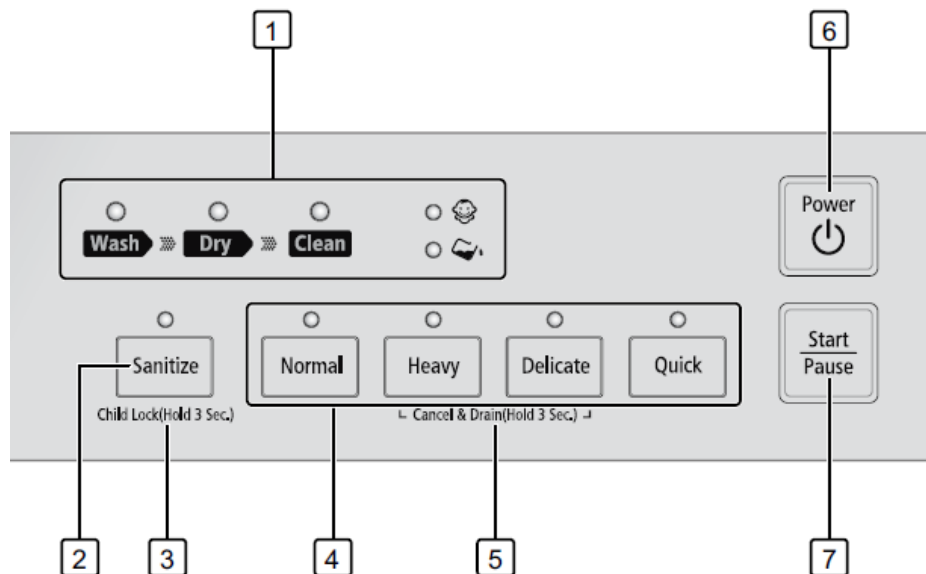

1 PROGRESS LIGHTS	The three Progress Lights turn on to show the progress of the current wash. To the right of the Progress Lights, the Child Lock Light turns on when you activate the Child Lock and the Rinse Aid Dispenser Light turns on when you need to refill the Rinse Aid Dispenser.
2 SANITIZE	The temperature rises to 162 F (72 °C) in the final rinse cycle for high temperature sanitization. If you select the Sanitize option, the "Sanitize" indicator blinks when the water temperature meets the sanitary temperature (over 155 F (68 °C)), and then illuminates for 10 minutes at the end of the cycle while it sanitizes. ⓘ The Sanitize feature is in accordance with NSF/ANSI Standard 184 for Residential Dishwashers. Certified residential dishwashers are not intended for licensed food establishments. Your dishwasher is NSF Certified. The cycle that is NSF certified is the Normal Cycle with the sanitize option selected.
3 CHILD LOCK	This option allows you to lock the buttons on the control panel. Children will not be able to accidentally start the dishwasher by pressing the buttons on the control panel when this option is selected. ⓘ When this option is selected, you can only operate Power button when no cycle is running. Activating/Deactivating - If you want to activate or deactivate this option, hold down the Sanitize button for three(3) seconds.

4 CYCLE SELECTOR	You can select the appropriate wash cycle depending on the soil level of your dishes. When you select a cycle, the indicator for that cycle lights up. If you want to cancel the selected cycle, press the selected cycle button again. If an error occurs during an operation, an error message is illuminated with a warning sound. Refer to the information codes page.
5 CANCEL & DRAIN	To cancel & drain a cycle currently running, hold down both the Heavy and Delicate buttons for three (3) seconds.
6 POWER	When pressed, all indicator lights turn on and off and the most recently finished cycle light lights up. When the dishwasher is running and a selected cycle is finished, the " Clean " light is illuminated for 10 minutes. The Power turns off automatically.
7 START & PAUSE	In Power on condition, close the dishwasher door and select the cycle and desired options. Press the Start/Pause button to begin the cycle. When you want to pause the dishwasher while running, press the Start/Pause button and make sure to open the door slowly and carefully.

Product Main Specification

MODEL name	DMT300RFS, DMT300RFB, DMT300RFW
Power supply	Single phase AC 110V / 60Hz
Water pressure	140 ~ 830 kPa (20 ~ 120 psi)
Wash method	Rotating nozzle spray type
Dry method	Air vent dry system
Power consumption	Standard cycle: 1.03 KWh \pm 10%
Power	Circulation Motor :185W \pm15% or below Heater : 1100W \pm10% or below Drain Pump : 45W \pm15% or below Fan Motor : 5.5W \pm15% or below
Water consumption	3.9~7.9 gallon(14.8~30ℓ), Normal cycle

Specification

		DMT300RFS	DMR57LFS(Basic)
Spec	Capacity	14 place settings	14 place settings
	Display	None	Graphic LED
	Control Type	Tact Button	Touch Sensor
	Inlay	-	-
	Washing Program	Normal, Heavy, Delicate, Quick	Normal, Heavy, Delicate, Rinse
		Sanitize	Delay Start, Sanitize
	Inlet Water	Exclusively for hot water	Exclusively for hot water
	Basket Color	Gray Color (Nylon Coating)	Gray Color (Nylon Coating)
	Basket	Stair Style Basket	Stair Style Basket
	Sensor	Inlet/Temp/Water Level/Rinse/Leakage	Inlet/Temp/Water Level/Rinse/Leakage
	Rinse Supplement Direction	Yes	Yes
	Half Load	No	No
	Filter	3-stage (Disposer Type)	3-stage (Disposer Type)
	Heater Type	Internal Type(1100W)	Internal Type(1100W)
	Dry Type	Air Vent Dry system	Fan driven condensing system
	Program Lock	Child Lock Button	Child Lock Button
	Reservation	No	1~24hr
	SIZE	605×627×860mm (W×H×D) 23-7/8 x 24-3/4 x 33-7/8 inch	605×627×860mm (W×H×D) 23-7/8 x 24-3/4 x 33-7/8 inch

Wiring Diagram

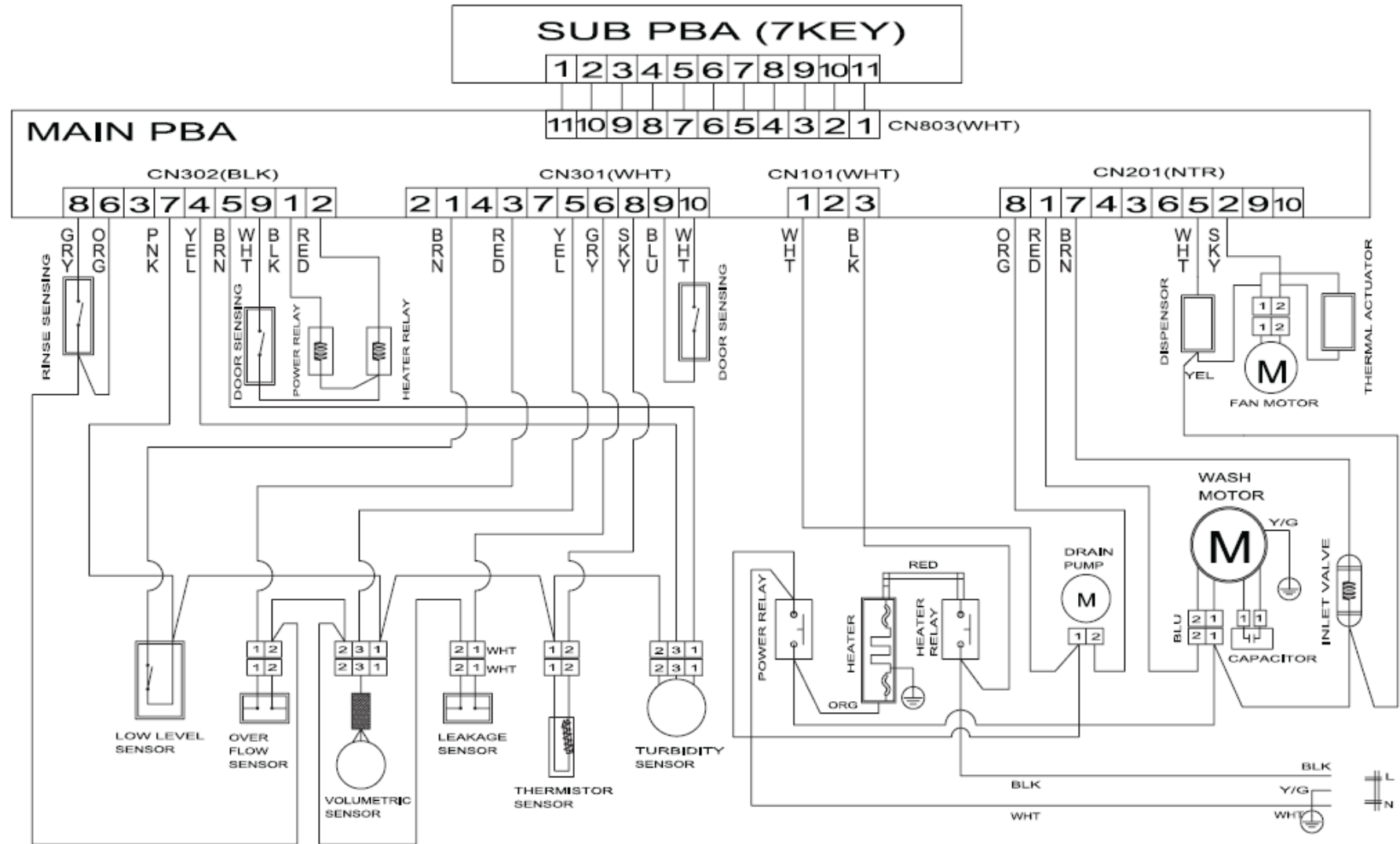

Schematic diagram

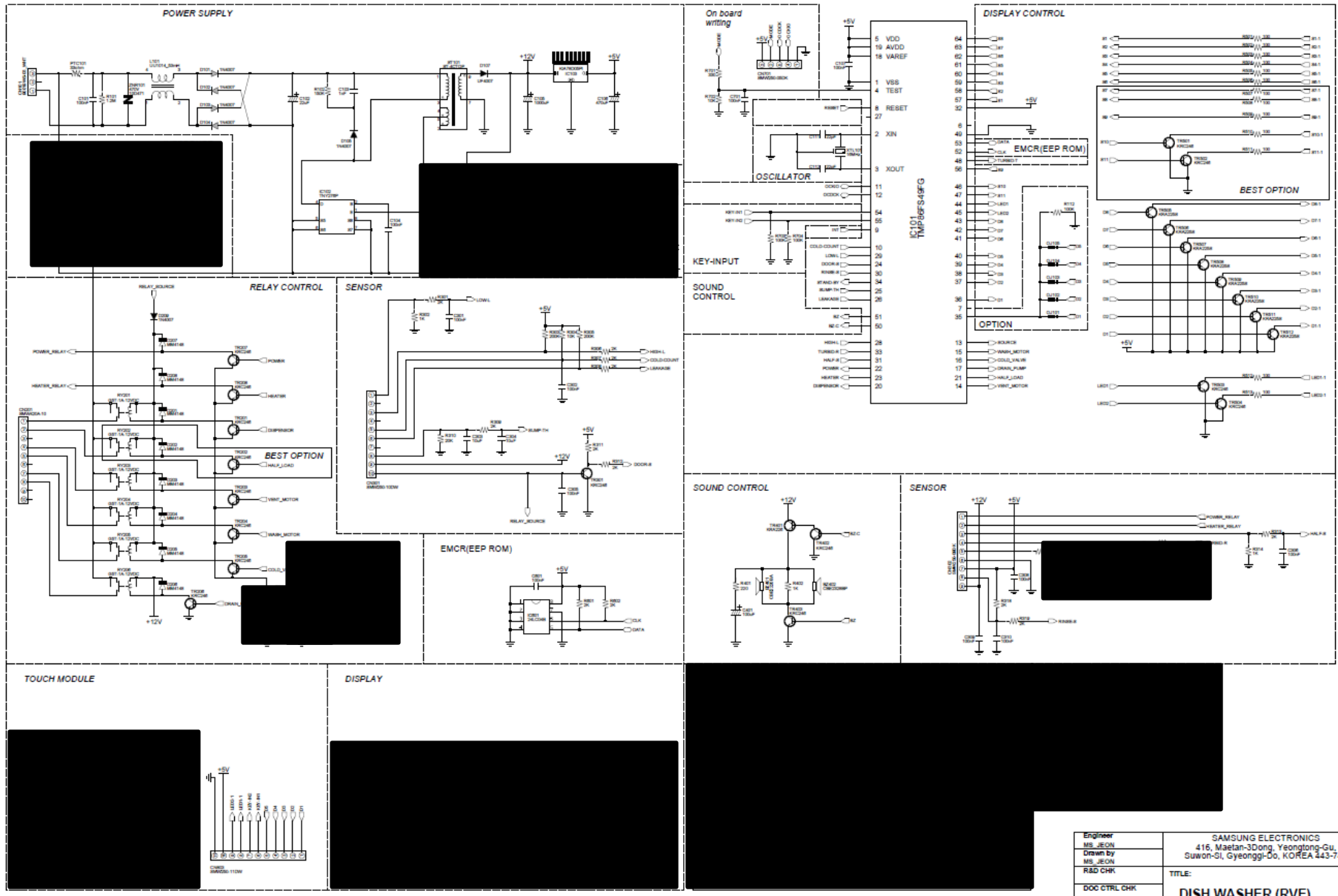

Engineer	SAMSUNG ELECTRONICS
MS_EJON	416, Maetan-3Dong, Yeongtong-Gu,
Drawn by	Suwon-CI, Gyeonggi-Do, KOREA 443-74
MS_EJON	TITLE:
R&D CHR	DISH WASHER (RVE)
DOC CTRL CHR	

Schematic

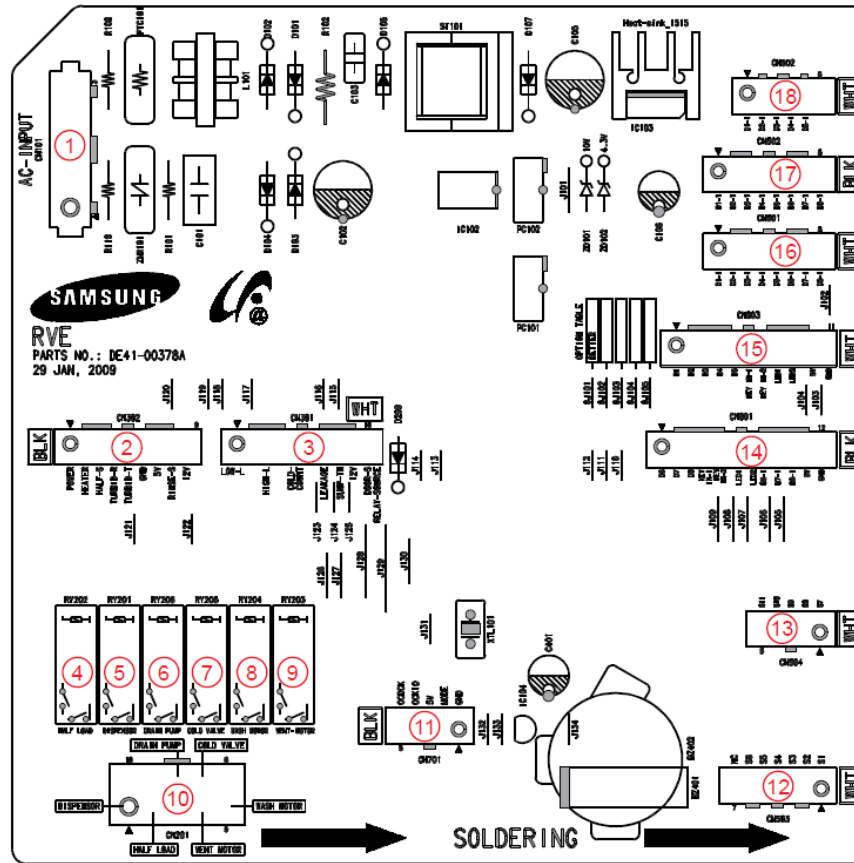

Location	Description
1	PBA Power (120V)
2	12V, DC GND, Power Relay Driver, Heater Relay Driver, Half Load Sensor, Turbidity Sensor, Rinse Aid Sensor
3	Low Water Level Sensor, Overflow Sensor, Cold Water Counter, Leakage Sensor, Temperature sensor, Door Sensor
4	NC
5	Dispenser Driving Relay
6	Drain Pump Driving Relay

Location	Description
7	Inlet Valve Driving Relay
8	Circulation (Wash) Motor Driving Relay
9	Vent Motor Driving Relay
10	AC Electric Driving connector
11	Micom Writer Connector
12	NC

Location	Description
13	NC
14	NC
15	Touch-Key, LED Driving, 5V, DC GND
16	NC
17	NC
18	NC

Detailed Specifications and Descriptions for Connectors and Relay Terminal(MAIN PBA)

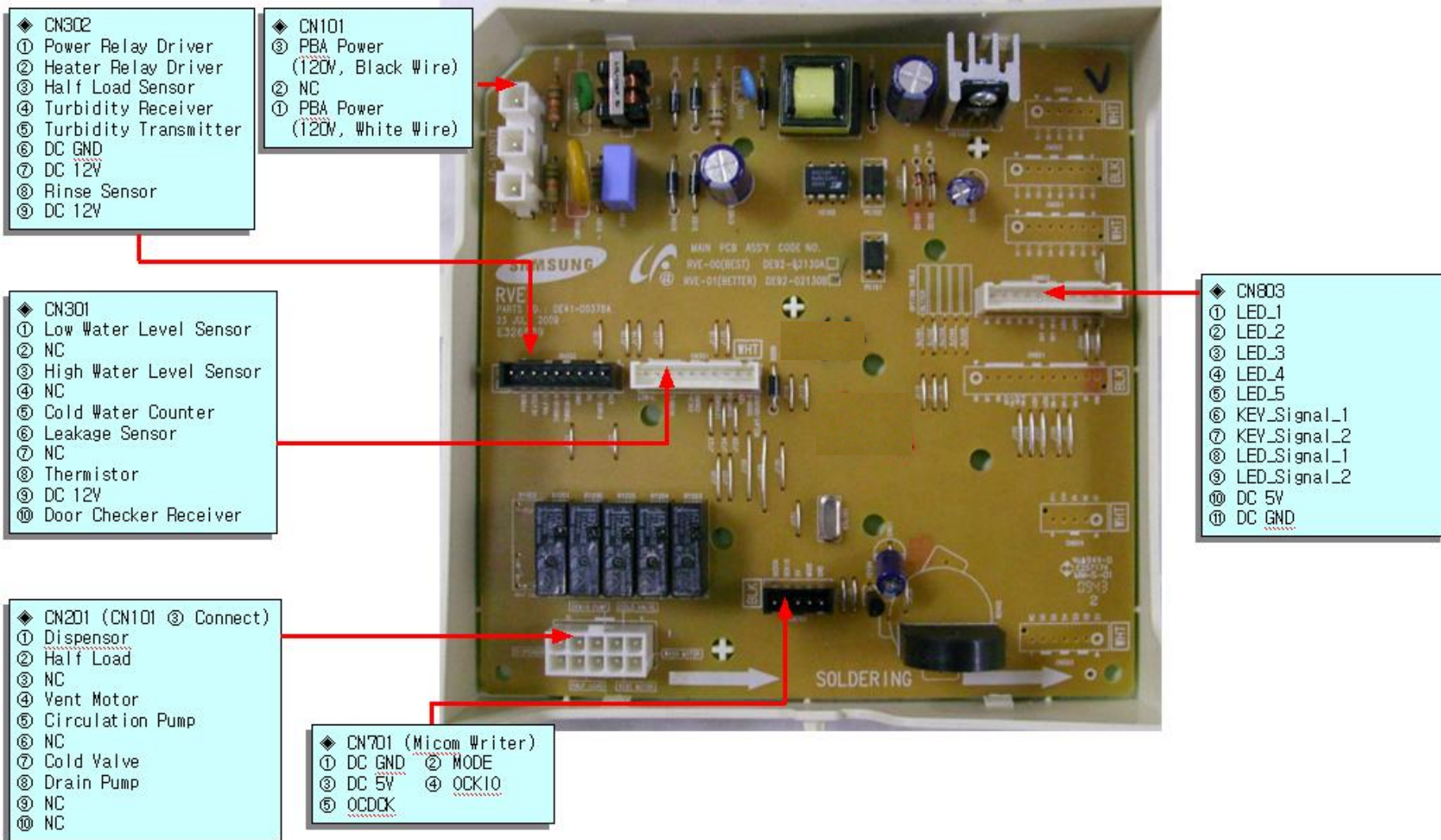

Sub PCB

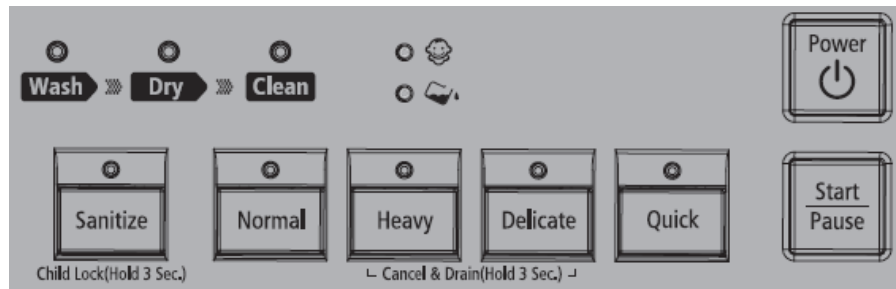
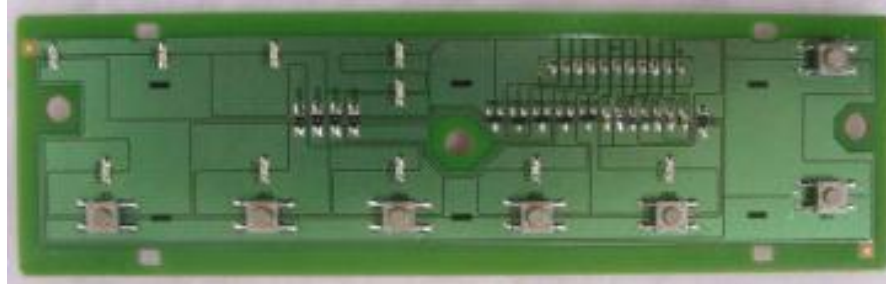

Preparation for parts replacement

1. Take out the residual water inside the product.
(Drain the water by operating the drain pump)
2. Close the water supply valve.
3. Turn off the power.
You must turn off the circuit breaker connected to the product.
4. Pull out the unit from the sink and lay it on the floor.
Be careful of the drain hose when pulling out the unit.

WARNING: Always turn off the electric power supply & water supply before servicing any electrical component, making ohmmeter checks, or replacing any parts.

Caution : Make sure to remove remain water in the dishwasher. If not, wet the floor. To prevent drop water on the floor, we recommend to lay the towel before laying down.

Note: All voltage checks should be made with a voltmeter having a full scale range of 250 volts or higher. After service is completed, be sure all safety grounding circuits are complete, all electrical connections are secure, and all access panels are in place.

Before servicing, make sure to remove all items include baskets inside dishwasher.

Disassembly and Reassembly - 1. THERMISTOR

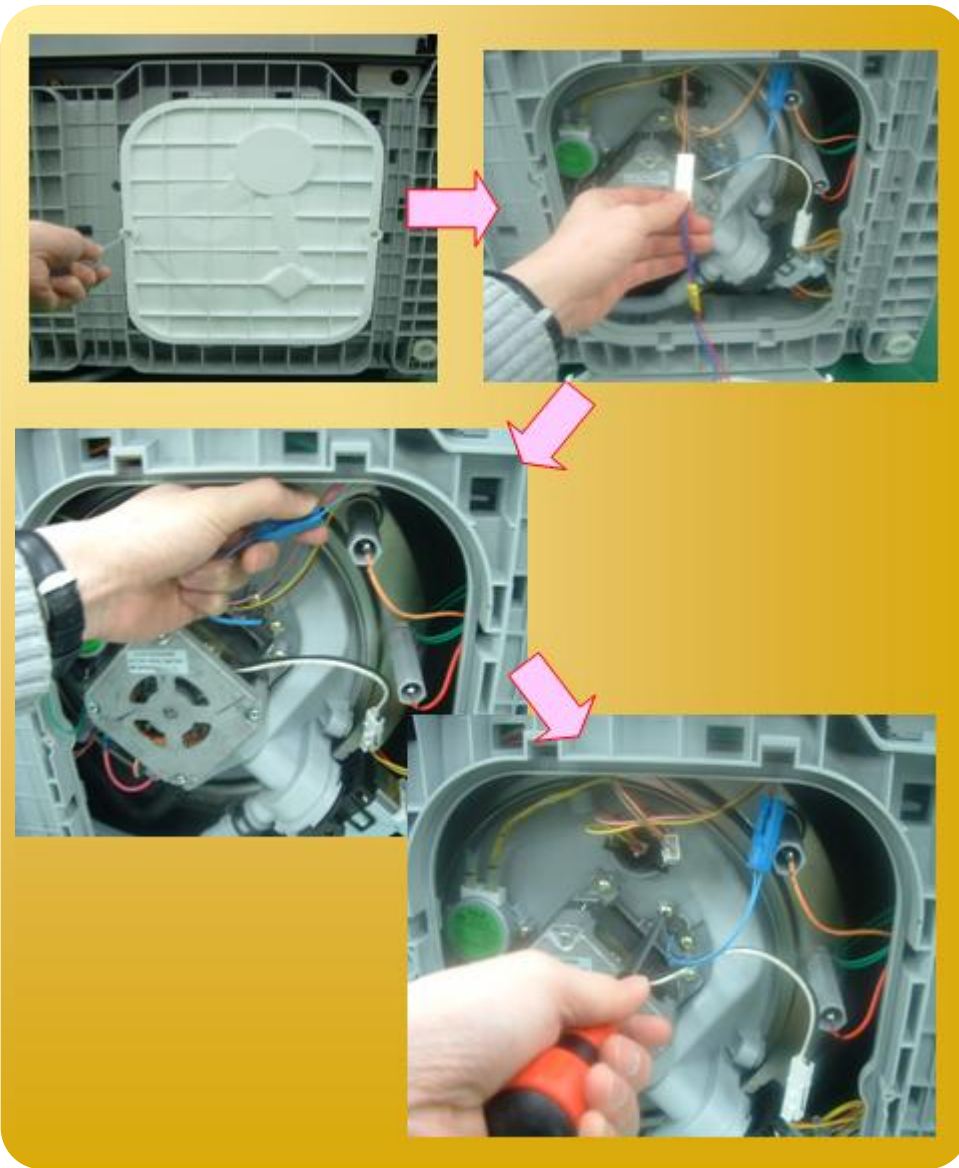

- 1) Lay the product down so that you can see the Base, and unscrew the 2 screws fixating the base and the shutter.
- 2) Separate the terminal of leakage sensor terminal of the shutter.
- 3) After checking the thermistor location, unscrew 2 screws fixating the case sump.
- 4) Disassemble the wire connected to the thermistor.

※ CHECK LIST

- ▶ Be careful of the residual water inside the unit from prior wash.
- ▶ Check the resistance of thermistor at 25°C : 49Ω (Refer to table by temperature)
- ▶ Check voltage between thermistor ends: 0.2V~4.5V

Disassembly and Reassembly - 2. HEATER (1/2)

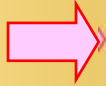

- 1) Open the door and separate the upper and lower baskets from the dish washer.
- 2) Separate the lower nozzle.
- 3) Separate the duct nozzle.
- 4) Disassemble the sump ass'y and separate the cover sump & cover heater.

Disassembly and Reassembly - 2. HEATER (2/2)



- 5) Lay the product down, and unscrew the 2 screws fixating the base and the shutter. Separate the terminal of leakage sensor terminal of the shutter.
- 6) After disassembling the terminal inserted to the heater, turn the holder heater in CCW direction to disassemble it.
- 7) Set the product upright and open the door to pull out the heater. Be careful of the interference with the heater bracket.

※ CHECK LIST

- ▶ Measure the resistance of the heater ends: 12Ω (Measure after removing the connecting terminal)
- ▶ Check the relay connecting terminal and check the operating signal

Disassembly and Reassembly - 3. PUMP DRAIN

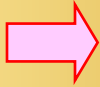

- 1) Lay the product down, and unscrew the 2 screws fixating the base and the shutter. Separate the terminal of leakage sensor terminal of the shutter.
- 2) Separate the terminals (2 units) of the pump drain.
- 3) Turn the pump drain in CCW direction to pull it out.

※ CHECK LIST

- ▶ Be careful of the residual water inside the unit from prior wash
- ▶ Check the drain motor coil resistance (25Ω): Measure product condition
- ▶ Check the voltage between the drain motor terminals of 120V
- ▶ PCB: Check CN1 – CN14 (120V)

Disassembly and Reassembly - 4. WATER VALVE

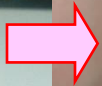
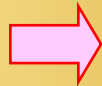
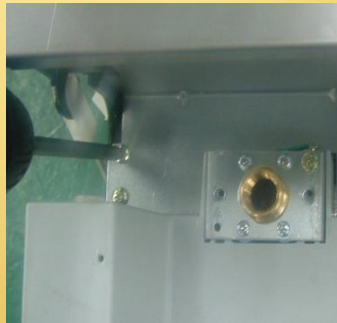
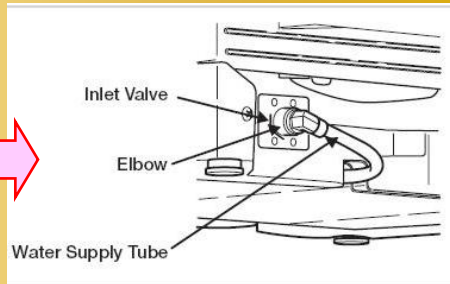

- 1) Disassemble the front lower cover. Check before disassembly. Lock the water supply valve connected to the water supply line before the disassembly.
- 2) Disassemble the front lower frame .
- 3) After separating the water supply hose connected to the water supply valve, disassemble the water supply valve. (2 screws)
- 4) Hold the water supply valve and pull it up to separate the clamp.

※ Check List

- ▶ Always lock the water supply valve connected to the water supply hose before disassembling.
- ▶ Check the voltage of the water supply valve terminals of 120V.
- ▶ Check PCB RELAY: Check CN1 – CN14(120V)

Disassembly and Reassembly - 5. PUMP CIRCULATION (1/2)

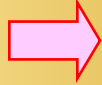

- 1) Open the door and pull out the upper and lower Baskets.
- 2) Separate the top, bottom and duct nozzle.
- 3) Disassemble the sump ass'y and separate the cover sump & cover heater.
- 4) Disassemble the circulation impeller and separate the case scroll.
- 5) Separate the cutter disposer.

Disassembly and Reassembly - 5. PUMP CIRCULATION (2/2)

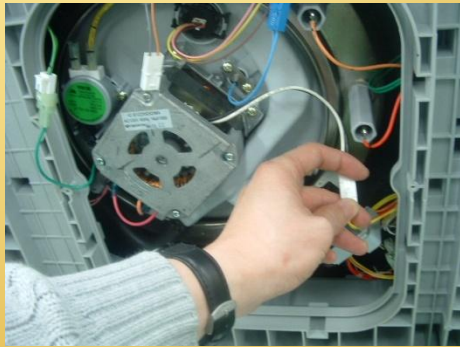
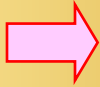

- 6) After laying the product down and disassembling the shutter, separate the leakage sensor terminal assembled on the shutter.
- 7) Separate the terminal of circulation motor.
- 8) Disassemble the circulation motor and separate it from the sump ass'y.

※ Check List

- ▶ Be careful of the residual water inside the unit from prior wash .
- ▶ Check the voltage of ends: 120V
- ▶ Check coil resistance: 16.5Ω (Measure product after removing connected terminal)
- ▶ PCB : Check CN1 -CN14 (120V)

Disassembly and Reassembly - 6. Panel Control part (1/2)

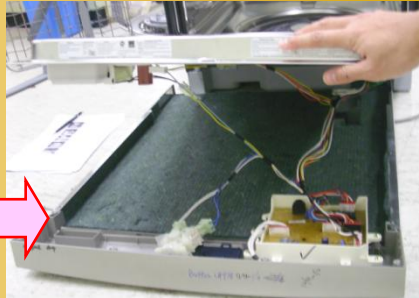

- 1) Open the door and unscrew the screws of front frame, front tub and panel control. (12 screws)
[Caution]
 - Always set a mat on the floor so that the front side of the frame does not get damaged during the work.
 - When you unscrew all the screws, the front tub can close up injuring the worker. Therefore be careful.

- 2) After separating the fan motor terminal and thermal actuator terminal, put the front frame ass'y down on the floor.

- 3) Pull out the terminal of the door S/W and then you can replace the door S/W.
[Proceed to 4) when disassembling display LED, display LED front or PCB ass'y.]

※ Check List

- ▶ Check the voltage between Door S/W ends
 - When open: 4.5~5.2V
 - When closed: 1V or below

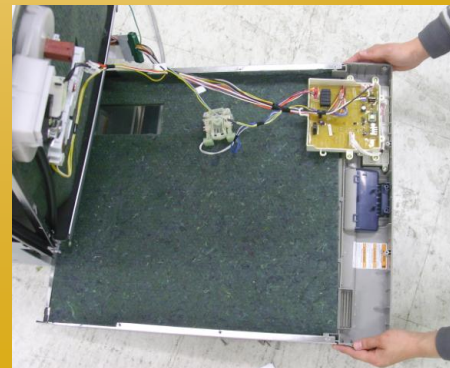
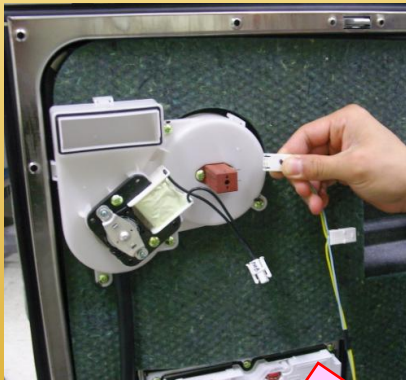

Disassembly and Reassembly - 6. Panel Control part (2/2)

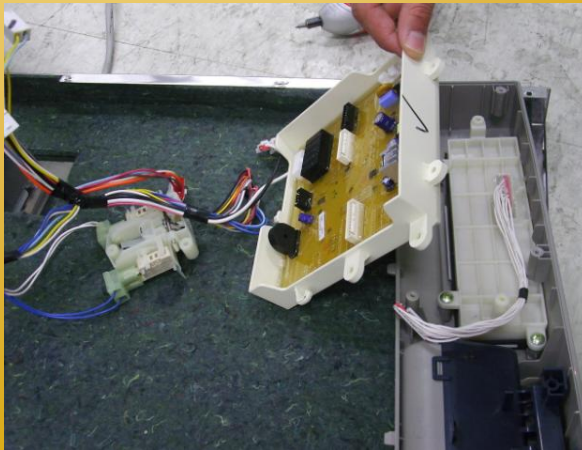
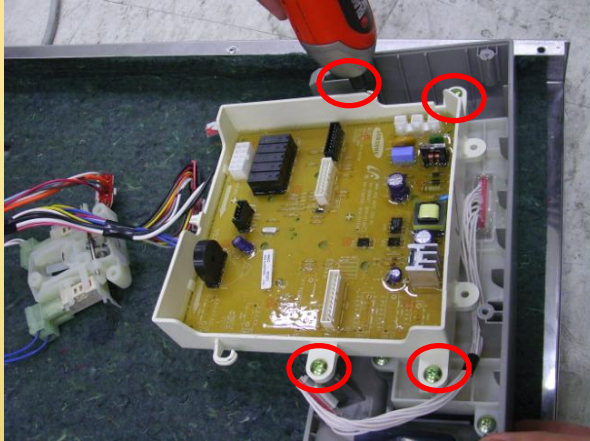

* PCB ass'y disassembly

- 4) Disassemble the PCB ass'y.(4 screws)
Separate all the terminals of PCB.

[Caution]

- When separating the terminal, always turn the power off before working.

* PCB tact ass'y disassembly

- 5) Disassemble the PCB tact ass'y.(3 screws)

[Caution]

- When reassemble the PCB tact ass'y, ensure to place the seal button on original location.

Disassembly and Reassembly - 7. DISPENSER

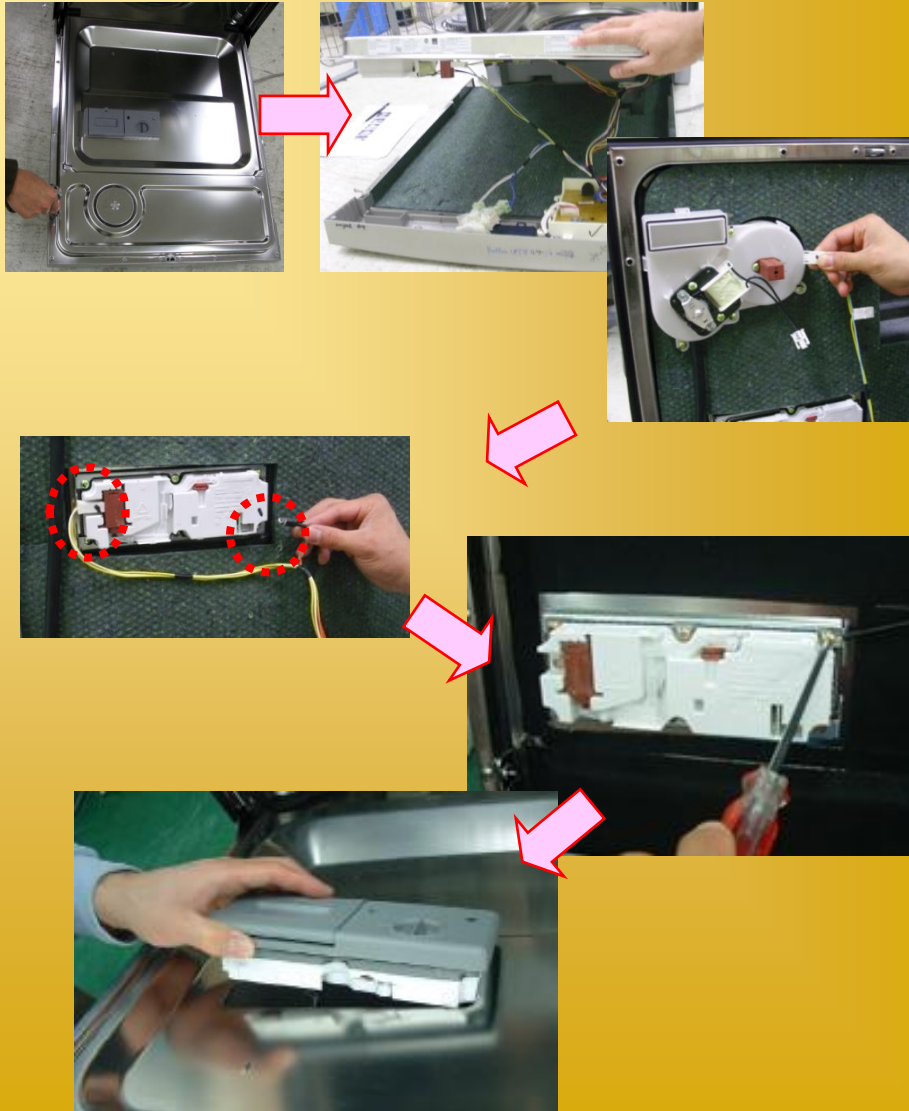

- 1) Open the door and unscrew the screws of front frame and front tub.(12 screws)
[Caution]
- When you unscrew all the screws, the front tub can close up injuring the worker.
- 2) After separating the fan motor terminal and thermal actuator terminal, put the front frame ass'y down on the floor.
- 3) Disassemble the terminal connected to the dispenser. You must disassemble both the left and right terminals.
- 4) Unscrew 6 screws fixating the dispenser. It is fixed to the tub front with a hook. Use a flat screwdriver to remove it from the tub front.

※ Check List

- ▶ Because there is a risk of leakage after replacement, check whether it is sealed properly.
- ▶ Check the voltage of both ends (120V) and measure the resistance of both ends (2.3Ω).

Disassembly and Reassembly - 8. FAN VENT ASSY (1/2)

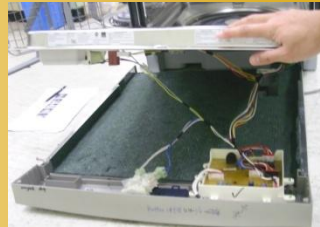

- 1) Open the door and unscrew the screws of front frame and front tub.(12 screws)
[Caution]
- When you unscrew all the screws, the front tub can close up injuring the worker.
- 2) After separating the fan motor terminal and thermal actuator terminal, put the front frame ass'y down on the floor.
- 3) Disassemble the bracket cover fan.(1 screw)
- 4) Disassemble the cover fan by rotating it CCW.
-Use a jig. If you have no jig, use a tool such as a pair of long nose pliers. Remove it carefully so that the part is not damaged.
- 5) Remove the 2 screws holding the cover fan in place.

Disassembly and Reassembly - 8. ASSY FAN VENT(2/2)

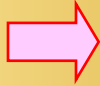

- 7) Hold and remove the case vent ass'y.
- 8) Remove the 2 screws holding the fan motor from the case vent ass'y. And carefully pull out the fan motor.
- 9) Unscrew the screws and disassemble of case vent.(3 screws)
- 10) Separate the case vent U and case vent L.
[Caution]
- Be careful not to break the hook.

※ Check List

- ▶ Because there is a risk of leakage after replacement, check whether it is sealed properly.
- ▶ Check the voltage of Fan Vent ends: 120V
- ▶ PCB RELAY : Check CN1 ~ CN14(120V)
- ▶ Measure coil resistance of both ends: 150Ω

Disassembly and Reassembly - 9. Case Sensor (1/2)



- 1) Unscrew the screws (2 screws) connecting the frame L.
 - When you separate the frame L, you can check the case sensor, and replace the micro S/W on the cover sensor part.
- 2) Separate the drain hose from the bracket hose drain.
- 3) Separate the case brake and cover brake.
[Caution]
 - When disassembling, you must use the jig for the cover brake. If you have no jig, you can use a pair of long nose pliers.

※ Check List

- ▶ Measure voltage of micro S/W ends: 4.5~5.25V after drain completion
- ▶ Measure product of micro S/W: Measure after removing the connecting terminal
 - When pulling the lever up: Short
 - When pulling the lever down: Open

Disassembly and Reassembly - 9. Case Sensor (2/2)



4) Separate the case sensor from the case brake.
[Caution]

- Be careful not to break the hook.

5) Separate the case sensor and cover sensor.
[Caution]

- Be careful not to break the hook.

6) Separate the pole sensor (2 units) from the cover sensor. Separate the terminal of the pole sensor.

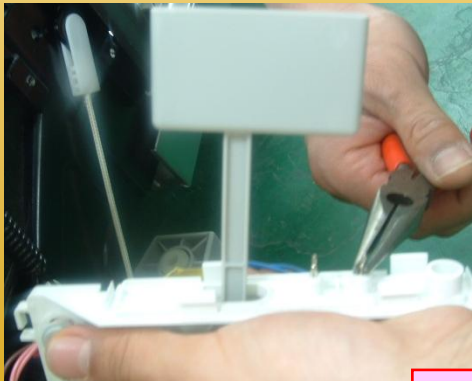

※ Check List

▶ Measure the voltage of micro S/W ends

: It is normal when the voltage is 0.5V or below after water supply is completed and 4.5~5.25V after water drain is completed.

▶ Measure the micro S/W product

: Short when the lever is pulled up and open when pulled down

Disassembly and Reassembly - 10. Distributor

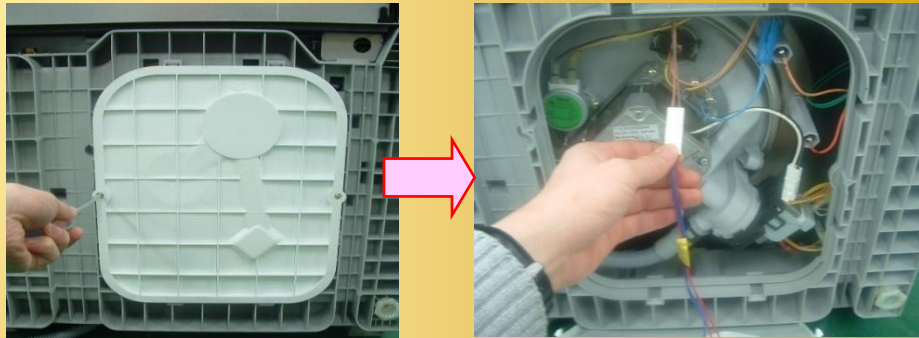

1) Place the dishwasher on its back so that you can see the base. Remove the two (2) screws that hold the base and the shutter in place.

2) Remove the leakage sensor connector (white) inside the shutter.

3) Remove the two (2) distributor motor connectors.

4) Remove the two (2) screws that hold the distributor Motor in place.
(You can remove one of the two screws through the hole in the base.)
Pull the distributor motor out.

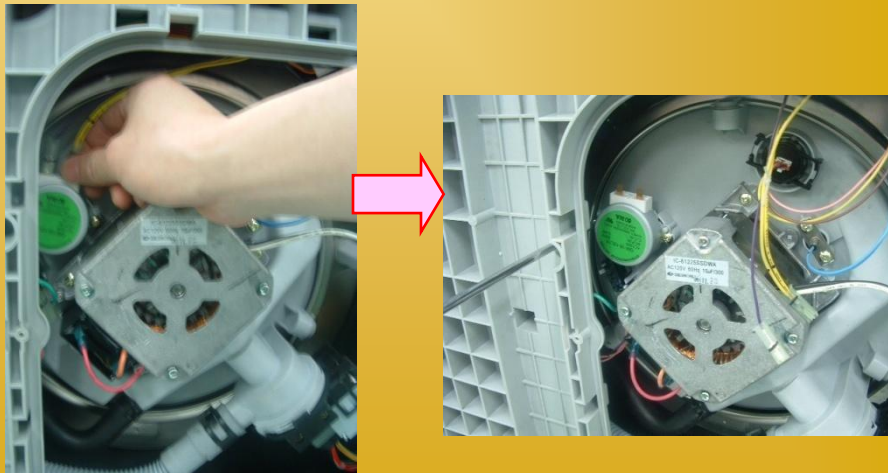

※ Check List

- ▶ Check PCB: Check CN1-Cn14 voltage (120V)
- ▶ Check the voltage of synchronous motor ends (120V)
- ▶ Check the resistance of synchronous motor ends (2.6kΩ)

Disassembly and Reassembly - 11. Relay

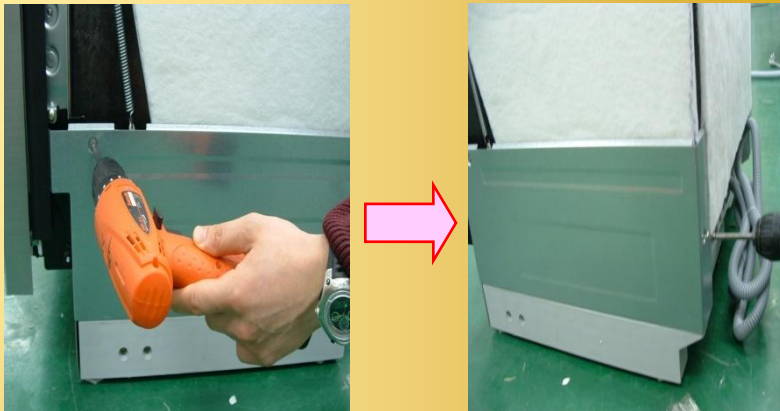

- 1) Unscrew the 2 screws connecting the frame R.
- 2) When you separate the frame R, you can check the fuse & relay.
- 3) Separate the terminal of relay.
Unscrew the screws of relay using short-body screwdriver.









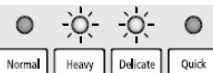

※ Check List

- ▶ If reassemble the terminal of Relay after check or replacement, you must be careful. Don't confuse.

Trouble Shooting

Error Codes

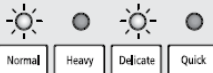
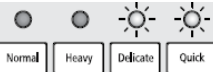
CODE SYMBOL	Meaning	Occurring condition	Expected causes
 Normal Heavy Delicate Quick	Temperature Sensor error	When 0.2V or below, or 4.5V or above is maintained for over 3 seconds	Thermistor terminal not connected Possible defect : Thermistor , Main PBA
 Normal Heavy Delicate Quick	Heater error	When the temperature change is 4°C or less within the first 10 minutes after the heating starts	Heater terminal not connected Possible defect : Main Wire-Harness, Heater , Heater Relay, Main PBA
 Normal Heavy Delicate Quick	High temperature Heating error.	When the temperature of the Thermistor is 80°C or above for more than 3 seconds	Water supply temperature of 80°C or above Possible defect : Thermistor , Main PBA
 Normal Heavy Delicate Quick	Low-level water error	When Low Level is detected to cause Error even after the water supply resumes after Low Level is detected for the 1 st time	Low Level Sensor terminal not connected Possible defect : Low Level Sensor , Main PBA
 Normal Heavy Delicate Quick	Water supply error	<ol style="list-style-type: none"> 1. When the pulse of 100 or less is detected even 1 minute after the water supply 2. When flow meter pulse is 5 or less 5 seconds after the water supply starts 3. When the water supply does not occur 5 minutes after the water supply starts 	Alien particles within water supply valve Water supply valve terminal not connected Possible defect : Main PB, Water supply valve , Flow Meter
 Normal Heavy Delicate Quick	High temperature Water supply error	When 80°C or above is detected during water supply	Water supply temperature of 80°C or above Possible defect : Thermistor, Main PBA
 Normal Heavy Delicate Quick	Drain error	When OFF status of Low Level S/W is not detected within 3 minutes during the drain.	Alien particles clogging mater drain hose Drain valve terminal not connected Possible defect : Drain pump, Low Level Sensor , Main PBA
 Normal Heavy Delicate Quick	Over-level water error	When overflow detection AD data is 4.0V or below for 3 seconds (When leakage sensor detects 4.0V or below for 1 seconds during water supply)	Alien particles within water supply valve Case Sensor part leakage Possible defect : Flow Meter, Main PBA
 Normal Heavy Delicate Quick	Leakage error	When leakage sensor detects 4.5V or below for 1 seconds	Possible defect : Base part hose connection , Sump and Tub assembly, Drain Pump assembly , Main PBA
 Normal Heavy Delicate Quick	Button error	When the button is pressed continuously for over 30 seconds	Possible defect : Sub PBA, Main PBA
 Normal Heavy Delicate Quick	Door open warning	When door is open in washing period.	Door is not close properly. Possible defect : Door lock switch, Main PBA

1. When the power does not come on

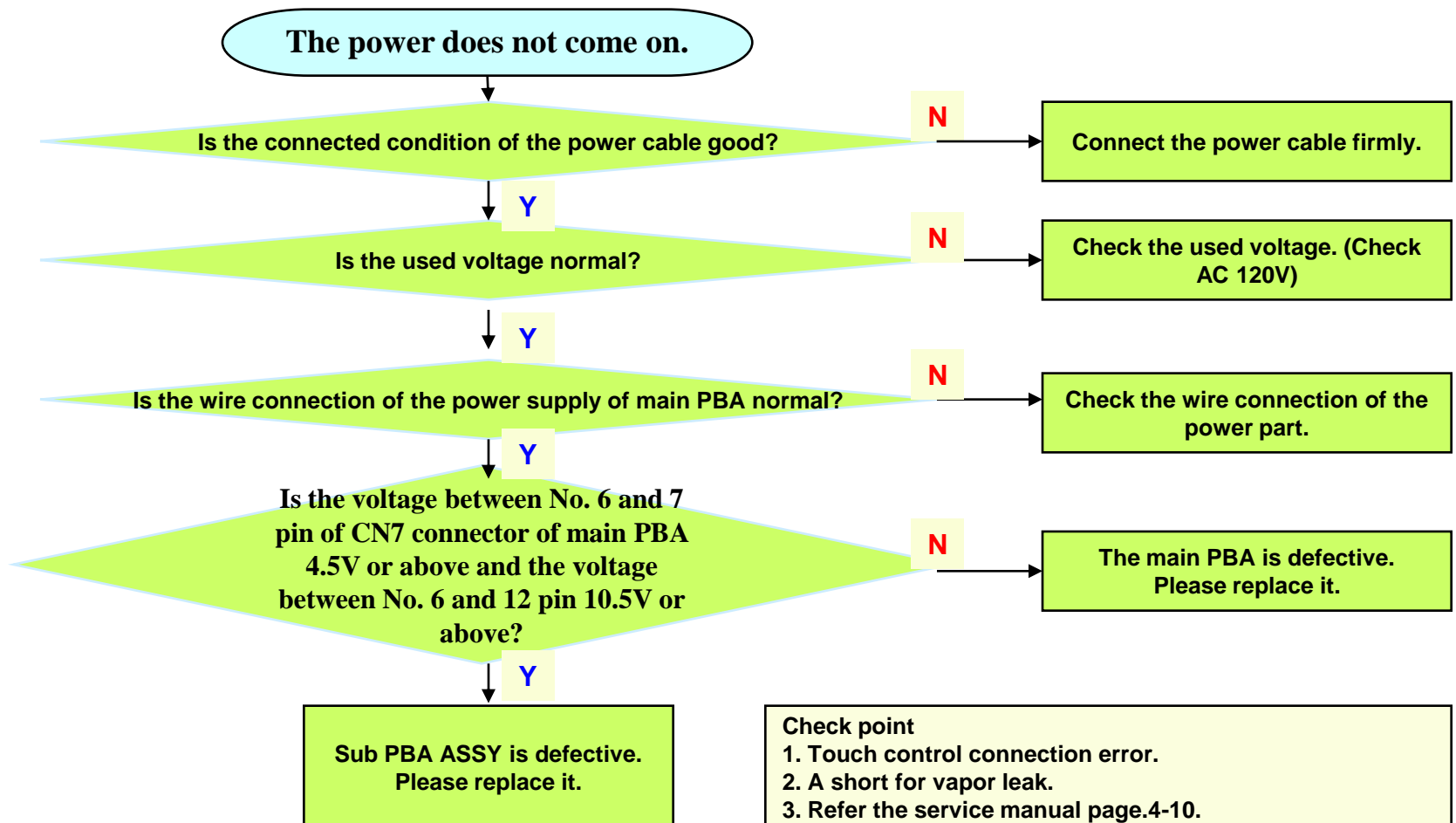

2. When the drain is not working

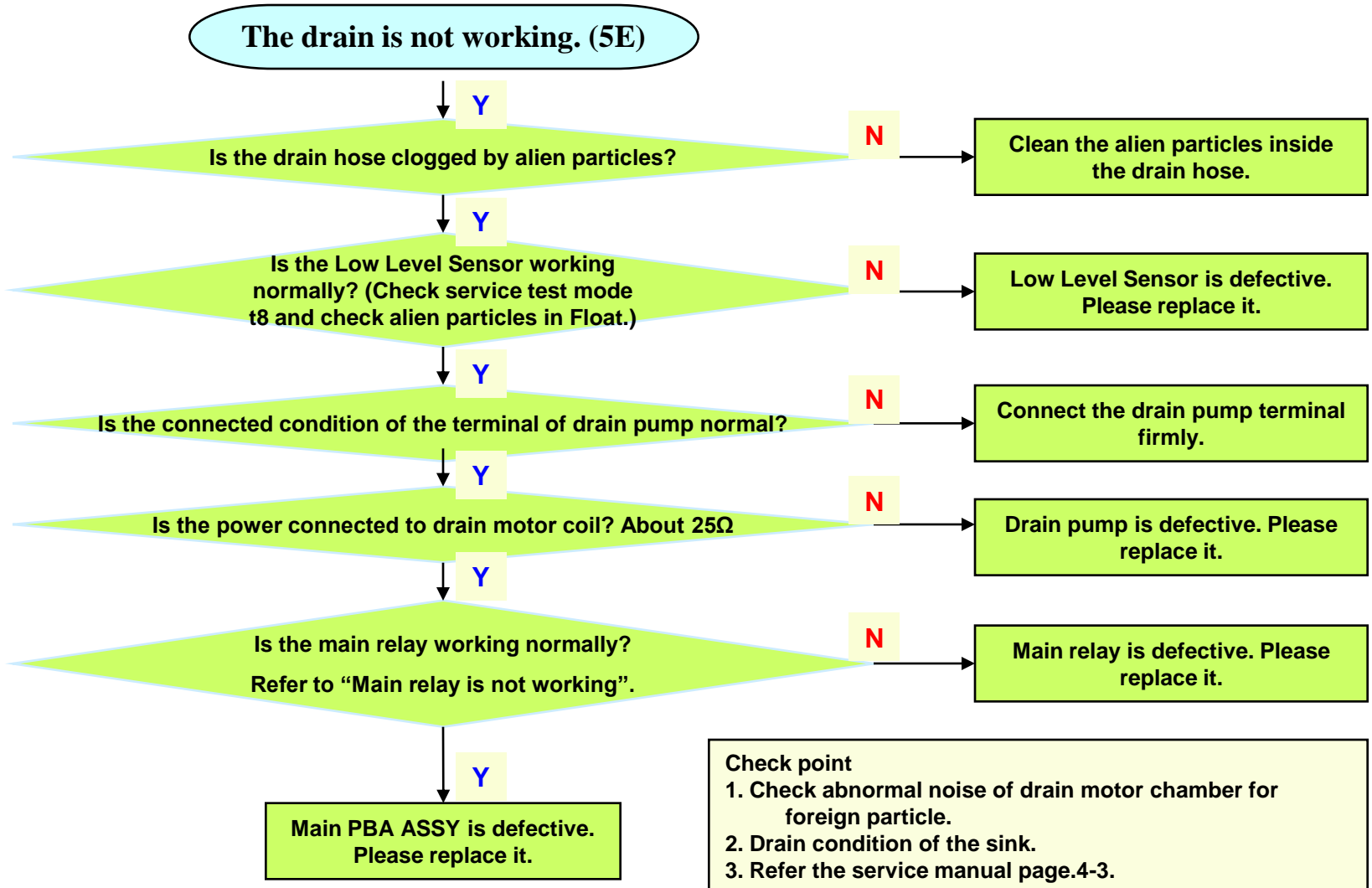

3. When water supply is not working

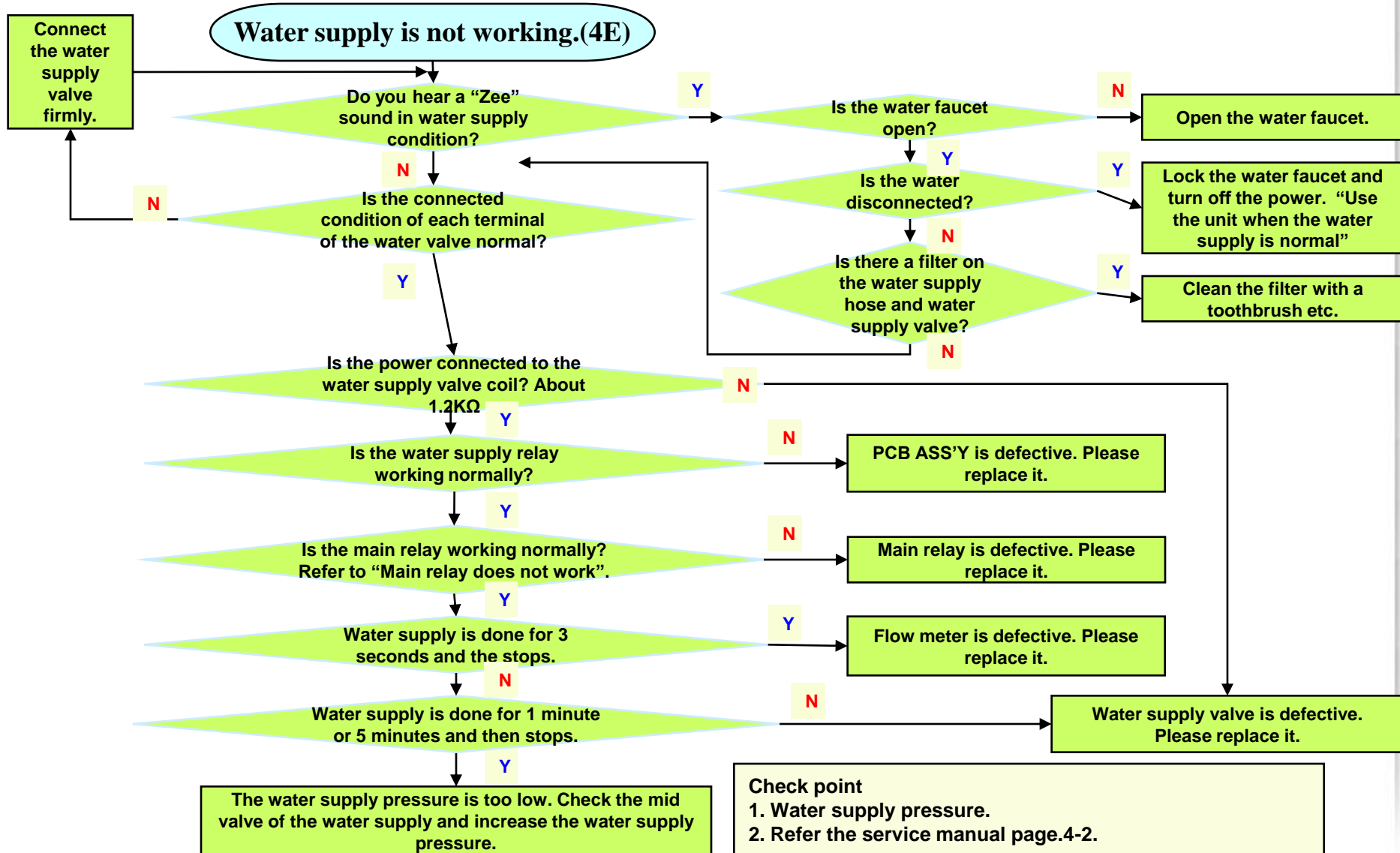

4. When dry is not working

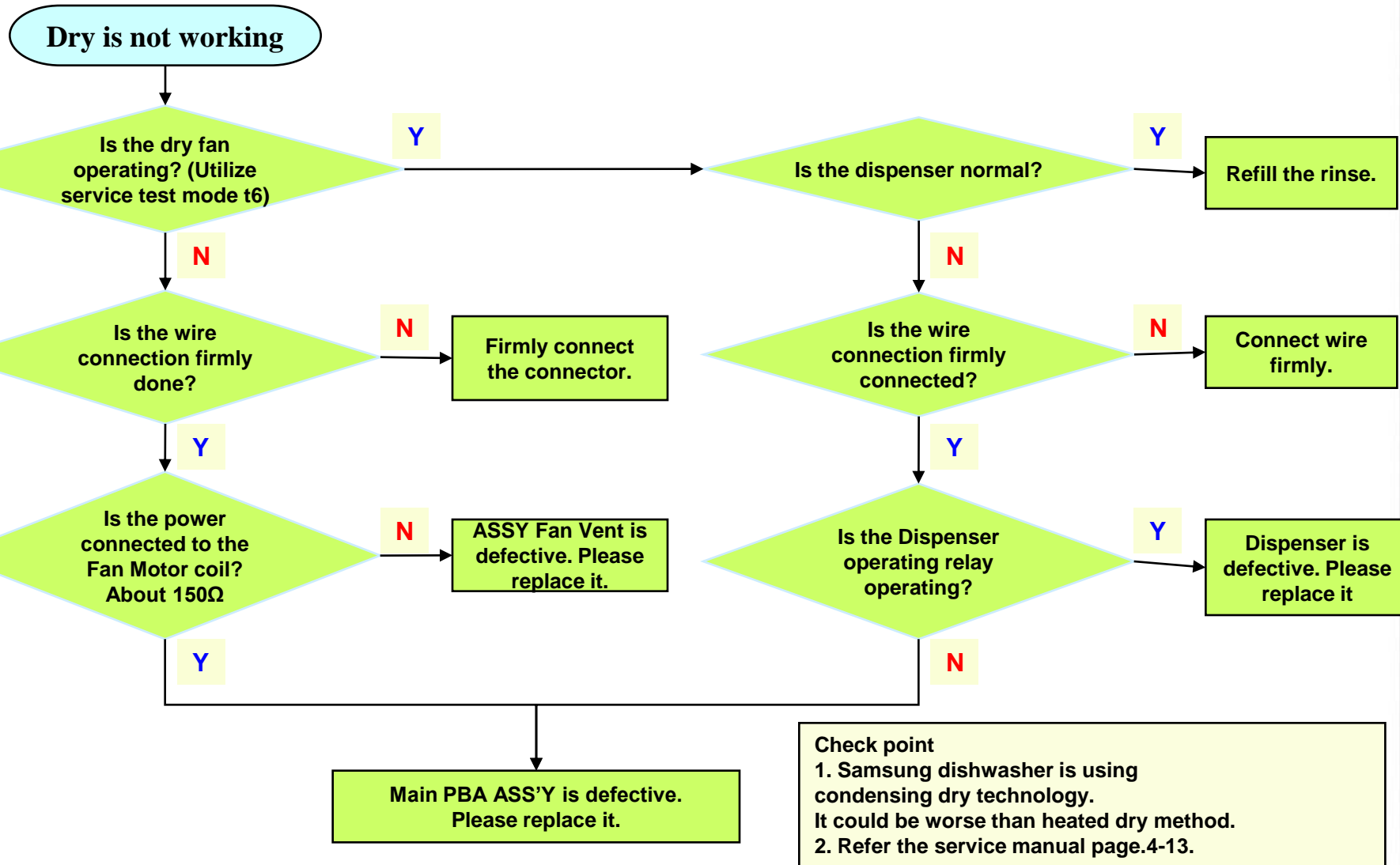

- Press the 'Heavy' + 'Delicate' + 'Power' buttons at the same time for two seconds to enter Service Inspection Mode.
- All LEDs are displayed for the first two seconds and then Software-Ver. It will be indicated Binary Code using 'Wash + Dry + Clean + Child Lock' LED.
- You can change the mode by pressing the Normal button once more. If press the Normal button in any mode, mode will be changed to next mode.
- If 'Heavy + Quick' LED, 'Heavy' LED or 'Heavy + Delicate + Quick' LED error occur, enter the Service Inspection Mode after resolving problem.
- Service Inspection Mode is described in the following table. When you activate this inspection mode, the door must be closed.

Mode	Display	Related Parts	Symptoms (LED Blinking)	Note
No.1	'Quick' LED	Inlet Valve Flow Meter Low Level Sensor	Water Supply Error Low Level Water Error 'Normal' + 'Heavy' + 'Delicate' LED	If Door is open, 'Delicate' + 'Quick' LED will blink. Water is supplying after low level S/W is detected. If low level S/W is high, Draining at first. If water is not supplied, Water Supply Error ('Quick' LED) will blink. When water level is low after water is supplied, Low Level Water Error ('Normal' + 'Heavy' + 'Quick' LED) will blink. When Turbidity problem is detected after water is supplied, 'Normal' + 'Heavy' + 'Delicate' LED will blink. If all functions in this mode are completed, 'Wash' LED will blink.
No.2	'Delicate' LED	Circulation Motor	A nozzle does not inject water.	If Low Level S/W is detected before Circulation Motor is operating, 'Sanitize' LED will blink.
No.3	'Delicate' + 'Quick' LED	Circulation Motor Heater Thermistor	Heater Error	If Low Level S/W is detected before Circulation Motor is operating, 'Sanitize' LED will blink. Circulation Motor and Heater will be operated. When the temperature is 60°C or above, the heater is turned off and 'Wash' LED will blink. If Heater or Thermistor have problems, the Heater Error ('Heavy' + 'Delicate' LED) will blink. Dispenser will operate during 2 minutes and 10 seconds only one time.
No.4	'Heavy' + 'Quick' LED	Fan Motor Dispenser	The Fan Motor does not work.	Operate Vent Motor and check whether Rinse aid is filled. If there is not rinse in Dispenser, Rinse Refilled light is ON.
No.5	'Heavy' + 'Delicate' LED	Overflow Sensor	Over level water error	Water is supplied until Over Level Water Error ('Heavy' + 'Quick' LED) is blinked. If Over Level Water Error occurs, overflow sensor is OK.
No.6	'Heavy' + 'Delicate' + 'Quick' LED	Drain Pump Low Level Sensor	Drain Error	Drain pump will work until low level is detected. If Low level is not detected after 60 seconds, Drain Error ('Delicate' LED) will blink.
No.7	'Normal' + 'Quick' LED	Inlet Valve Circulation Motor Fan Motor Drain Pump Heater		Operate each operating part when the button is pressed. (See the below) When the 'Quick' button is pressed, it toggles between Inlet Valve On ('Quick' LED On) -> Off ('Quick' LED Off). When 'Heavy' button is pressed, it works Circulation Motor On ('Heavy' LED On) -> Off ('Heavy' LED Off) -> Fan Motor On ('Heavy' LED On) -> Off ('Heavy' LED Off), Drain Pump On ('Heavy' LED On) -> Off ('Heavy' LED Off) When 'Delicate' button is pressed, it works Heater On ('Delicate' LED On during 2 seconds). When a different button is pressed during individual operation of the operating part, operating part is stopped and the applicable operation for the pressed button's function will start.

Trouble Shooting







Program chart

(●: Basic, ○: Flexible step)

Cycle	Pre-wash1	Pre-wash2	Main wash	Rinse1	Rinse2	Rinse3	Last Rinse [Sanitize]	Dry	Water [gal(ℓ)]	Time (min)
Normal	●	○	● 120 °F ~138 °F (49~59 °C)	●	○		● 136 °F (58 °C) [162 °F (72 °C)]	●	3.9~7.9 (14.7~30)	135~165
Heavy	●	●	● 149 °F (65 °C)	●	●	●	● 158 °F (70 °C) [162 °F (72 °C)]	●	9.2 (34.8)	193
Delicate	●		● 122 °F (50 °C)	●			● 140 °F (60 °C)	●	5.2 (19.7)	120
Quick	●		● 122 °F (50 °C)	●			● 140 °F (60 °C) [162 °F (72 °C)]		5.2 (19.7)	81

- The numbers in parentheses in the Last Rinse column represent the temperature when Sanitize is selected. The wash time is the same.
- When Normal cycle is selected, the ○ (flexible) steps can be eliminated depending the amount of soil on the dishes.
- If you select the Delicate cycle, the Sanitize option is disabled to prevent damage to delicate china and glassware.
- The wash time varies depending on the added steps.
- The wash time may vary depending on the water pressure, drain conditions, and temperature of the supplied water.

Trouble Shooting

Error Type	Error Mode	Checking Method	Corrective actions
Water supply Error	'Quick' LED	1. Check whether the faucet is open.	- Open the faucet.
		2. Check whether the water supply has been cut off.	- Close the faucet and turn off the power. Wait until the water supply resumes.
		3. Check whether any foreign material is in the Water Supply Line and the Inlet Valve filter.	- Remove the foreign material. Clean the filter with a brush.
		4. Check the connection for the Inlet Valve connector.	- Reconnect the Inlet Valve connector.
		5. Check whether the coil in Inlet Valve is conductive (Remove the connector before measuring.) ➤ Normal: Approx. 1.2 kΩ	- Faulty: Replace the Inlet Valve. 
		6. Check whether the Inlet Valve is operating normally. - Check the operation of the Inlet Valve ➤ Normal: 120V - Check the Inlet Valve Relay. : Check the voltage between the white wire of the Main PBA CN101 connector and the brown wire of the CN201 ➤ Normal: 120V (while operating)	- Faulty: Replace the Main PBA assy. - Normal: Replace the Inlet Valve  - Remove Retainer.   - Check voltage   
		7. Check the Power Relay.	- See the "Power Relay error".
		8. Check whether the water supply stops after water is supplied for 5 seconds.	- Replace the Flow Meter.
		9. Check whether the water supply stops after water is supplied for 1 or 5 minutes.	- Check the water supply valve and increase the water pressure.

Trouble Shooting



Error Type	Error Mode	Checking Method	Corrective actions
High Temperature Water supply Error	'Normal' + 'Delicate' + 'Quick' LED	1. Check the hot water connections for the Inlet Valve.	- Adjust the hot water supply so that the temperate of the supplied water is less than 176°F (80°C)
		2. Check the operation of the Thermistor.	- See the "Temperature sensor error".
Drain Error	'Delicate' LED	1. Check whether there is any foreign material in the Drain Hose.	- Remove the foreign material from the Drain Hose.
		2. Check the operation of the Low Level Sensor.	- See the "Low Level Water Error".
		3. Check the connections for the Drain Pump connector.	- Reconnect the Drain Pump connector.
		4. Check whether the Drain Pump coil is conductive. (Remove the connector before measuring.) ➢ Normal: Approx. 25Ω	- Faulty: Replace the Drain Pump.
		5. Check the operation of the Drain Pump Relay : Check the operating voltage between the white wire of the Main PBA CN101 connector and the amber wire of the CN201 connector. ➢ Normal: 120V (while operating)	- Faulty: Replace the Main PBA assy. - Normal: Replace the Drain Pump. - Remove Retainer.
		6. Check the operation of the Power Relay.	- See the "Power Relay error".





- Check voltage



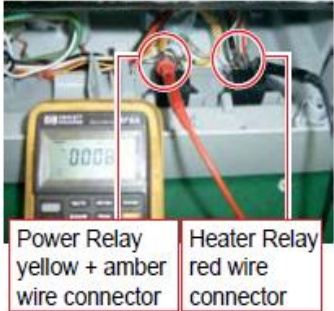

Trouble Shooting

Error Type	Error Mode	Checking Method	Corrective actions
Low Level Water Error	'Normal' + 'Heavy' + 'Quick' LED	1. Check the connections for the Low Level Sensor connectors.	- Reconnect the Low Level Sensor connector. 
		- Faulty: Replace the Low Level Sensor, Remove foreign material from the floater - Normal: Replace the Main PBA assy.	- Faulty: Replace the Low Level Sensor, Remove foreign material from the floater - Normal: Replace the Main PBA assy. 
Button Error	'Normal' + 'Delicate' LED	Check whether there is condensation on the Main PBA connector (CN803) ➢ Normal: No condensation	- Faulty: Remove any condensation and moisture. - Normal: Replace the Control Panel assy.

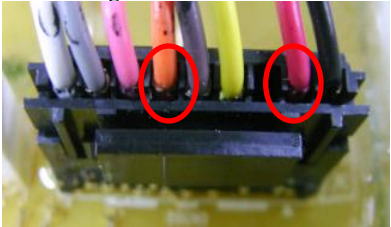
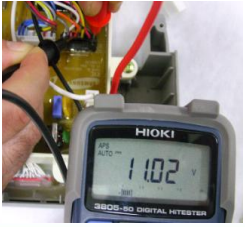
Trouble Shooting

Error Type	Error Mode	Checking Method	Corrective actions
Heater Error	'Heavy' + 'Delicate' LED	1. Check the connections of the Heater connectors.	- Reconnect the Heater connectors.
		2. Check the resistance between both ends of the Heater. : Check the resistance between both ends of the Heater directly, or check the resistance between the red wire of the Heater Relay and the amber and yellow wires of the Power Relay, respectively. ➢ Normal: Approx. 13Ω ☐ Check after disconnect circuit breaker or power cable.	- Faulty: Replace the Heater. 
		3. Check the connections of the Heater Relay. : Check the voltage between the red wire of the Heater Relay on the base and the yellow and amber wires of the Power Relay. ➢ Normal: 120V (while operating)	- Reconnect the Heater Relay connectors.  Power Relay yellow + amber wire connector Heater Relay red wire connector
		4-1. Check the driving signals for the Heater Relay. - Measure the voltage between pin 6 (amber) of the Main PBA CN302 connector and pin 2 (red) of the CN302 connector. ➢ When the Heater is off: 9.5 to 12.5V ➢ When the Heater is operating: < 0.5V	- Faulty: Replace the Main PBA assy. - Normal: Replace the Heater Relay. - Remove Retainer.  - Check voltage  





Trouble Shooting

Error Type	Error Mode	Checking Method	Corrective actions
High Temperature Heating Error	'Normal' + 'Quick' LED	1. Check the hot water connections for the Inlet Valve.	- See the "Thermistor error".
		2. Check the operation of the Thermistor.	- See the "Heater Error".
Water Leakage Error	'Heavy' LED	Check whether there is any trace of water leakage in the shutter. ➤ Normal: No water leakage trace	- Faulty: Check the leakage location. Replace the faulty part. - Normal: Replace the Main PBA assy.
Overflow Error	'Heavy' + 'Quick' LED	1. Check the connections for the Overflow Sensor connector.	- Reconnect the Overflow Sensor connector. 
		2. Check whether the Inlet Valve operates normally.	- See "Water supply Error".
		3. Check whether water is supplied (even small amounts) in the intervals when the Inlet Valve is not operating.	- Remove foreign material from the Inlet Valve. - If you cannot remove the foreign material from the Inlet Valve, replace it.
		4. Check whether there is any trace of water leakage on the top of the Case Sensor.	- Clean the Hose-Sensor and the Case Sensor. 
		5. Check whether an "Overflow Error" is detected when the assy wire-harness connector for Overflow Sensor is not connected. ➤ Normal: The "Overflow Error" does not occur.	- Faulty: Replace the Main PBA assy. - Normal: Replace the Flow Meter. 





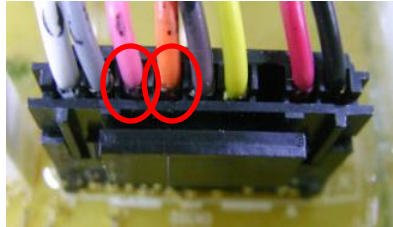
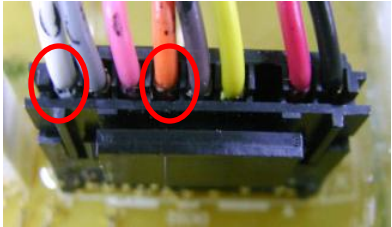

Trouble Shooting

Error Type	Error Mode	Checking Method	Corrective actions																																
Thermistor Error	'Heavy' + 'Delicate' + 'Quick' LED	1. Check the connections for the Thermistor connector.	- Reconnect the Thermistor connector.																																
		2. Check whether the Thermistor is operating normally. <ul style="list-style-type: none"> - Measure the voltage between both ends of the Thermistor. <ul style="list-style-type: none"> > Normal: 0.2 to 4.5V - Measure the resistance between both ends of the Thermistor: Remove the connector before measuring. (See the Table right.) 	- Faulty: Replace the Thermistor. - Normal: Replace the Main PBA assy.																																
		<table border="1" style="margin: auto;"> <thead> <tr> <th colspan="2">THERMISTOR TABLE</th> </tr> <tr> <th>Temp. (°C)</th> <th>Resistance (kΩ)</th> </tr> </thead> <tbody> <tr><td>5</td><td>125.780</td></tr> <tr><td>10</td><td>98.323</td></tr> <tr><td>15</td><td>77.454</td></tr> <tr><td>20</td><td>61.465</td></tr> <tr><td>25</td><td>49.120</td></tr> <tr><td>30</td><td>39.517</td></tr> <tr><td>35</td><td>31.996</td></tr> <tr><td>40</td><td>26.065</td></tr> <tr><td>45</td><td>21.358</td></tr> <tr><td>50</td><td>17.599</td></tr> <tr><td>55</td><td>14.579</td></tr> <tr><td>60</td><td>12.140</td></tr> <tr><td>65</td><td>10.159</td></tr> <tr><td>70</td><td>8.542</td></tr> </tbody> </table>	THERMISTOR TABLE		Temp. (°C)	Resistance (kΩ)	5	125.780	10	98.323	15	77.454	20	61.465	25	49.120	30	39.517	35	31.996	40	26.065	45	21.358	50	17.599	55	14.579	60	12.140	65	10.159	70	8.542	
THERMISTOR TABLE																																			
Temp. (°C)	Resistance (kΩ)																																		
5	125.780																																		
10	98.323																																		
15	77.454																																		
20	61.465																																		
25	49.120																																		
30	39.517																																		
35	31.996																																		
40	26.065																																		
45	21.358																																		
50	17.599																																		
55	14.579																																		
60	12.140																																		
65	10.159																																		
70	8.542																																		
																																			

Trouble Shooting

Error Type	Error Mode	Checking Method	Corrective actions
Power Error	None	1. Check the connections for the power plug.	- Reconnect the power plug.
		2. Check the voltage of the power outlet. ➤ Normal: AC 120V	- Connect to a 120V power source.
		3. Check the wires of the Main PBA power part. - Measure the voltage between the black wire and the white wire of CN101. ➤ Normal: AC 120V	- Faulty: Check and replace the wires of the power part. - Remove Retainer.  - Check voltage  
		4. Check the DC voltage of the Main PBA.	- See "Main PBA DC voltage error".
Main-PBA DC Voltage Error	None	<p>Check the DC voltage of the Main PBA.</p> <ul style="list-style-type: none"> - Measure the voltage between pin 6 (amber) of the main PBA CN302 connector and pin 7 (pink) of the CN302 connector. ➤ Normal: 4.5V to 5.5V - Measure the voltage between pin 6 (amber) of the main PBA CN302 connector and pin 9 (white) of the CN302 connector. ➤ Normal (Power Key On): 9.5V to 12.5V ➤ Normal (Power Key Off): 5.5V to 7.0V 	<p>- Faulty: Replace the Main-PBA Assy. - Remove Retainer. </p> <p>- Check voltage (4.5V~5.5V) - Check voltage (9.5V~12.5V or 5.5V~7.0V)</p>  

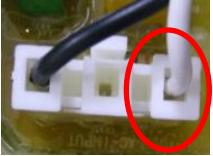

Trouble Shooting

Error Type	Error Mode	Checking Method	Corrective actions
The nozzle does not inject water.	None	1. Check the connections for the Circulation Motor connector.	- Reconnect the Circulation Motor connector.
		2. Check the connections for the Startup Condenser connector of the Circulation Motor.	-Reconnect the Startup Condenser connector of the Circulation Motor. 
		3. Check the resistance for the Circulation Motor coil. (Remove the connector before measuring.) ➤➤ Normal: Approx. 14.2 Ω	- Faulty: Replace the Circulation Motor. 
		4. Check the operation of the Circulation Motor Relay. Check the operating voltage between the white wire of the CN101 connector and the red wire of the CN201 connector. ➤ Normal: 120V (while operating)	- Faulty: Replace the Main PBA assy. - Normal: Replace the Circulation Motor. Remove Retainer. - Remove Retainer.   - Check voltage   
		5. Check whether there is foreign material in the water passages.	- Remove foreign material from the water passages.

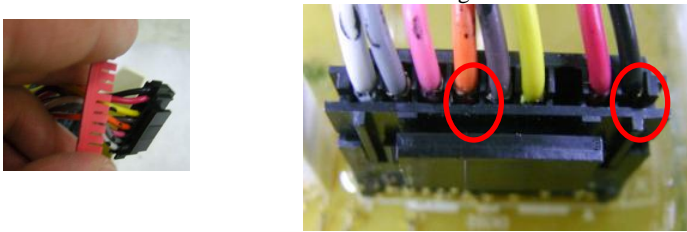

Trouble Shooting

Error Type	Error Mode	Checking Method	Corrective actions
The Cycle does not start.	None	1. Check the connections for the Door Sensing Switch : Check the blue wire and the switch connected to the blue wire. <ul style="list-style-type: none"> ➢ Normal (Power Key On): 9.5 to 12.5V (when the door is open) ➢ Normal (Power Key Off): 5.5 to 7.0V (when the door is open) ➢ Normal : <2V (when the door is closed) 	- Reconnect the Door Sensing Switch connectors 
		2. Check the operation of the Door Sensing Switch. (Remove the connector before measuring.) : Check the blue wire and the switch connected to the blue wire. <ul style="list-style-type: none"> ➢ Normal: OPEN (when the door is open) ➢ Normal: SHORT (when the door is closed) 	- Faulty: Replace the Door Sensing Switch. - Normal: Replace the Main PBA assy.
No Washing	None	1. Check whether the nozzle injects water normally.	- See "The nozzle does not inject water".
		2. Check the operation of the Heater.	- See "Heater Error".





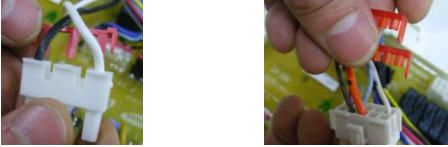

Trouble Shooting

Error Type	Error Mode	Checking Method	Corrective actions
Power Relay Error	None	<p>1. Check the connections for the Power Relay connector. : Start the cycle by pressing the Power key. Then measure the operating voltage between the black wires of the Heater Relay, and the operating voltage between the yellow and amber wires of the Power Relay.</p> <p>Caution Check the color of the wires of the Power Relay and the Heater Relay. ➢ Normal: 120V</p>	<p>- Reconnect the Power Relay.</p> 
		<p>2. Check the door switch. : Check the white wire and the switch connected to the white wire.</p> <ul style="list-style-type: none"> ➢ When the door is open : The Door Switch is OFF. ➢ When the door is closed : The Door Switch is ON. <p>☐ The Power Relay and the Heater Relay use a 12V line. If the switch is out of order, the Power Relay and the Heater Relay will not operate.</p>	<p>- Faulty: Replace the Door Switch.</p>
		<p>3. Check the driving signals for the power relay : Measure the voltage between pin 6 (amber) and pin 1 (black) of the CN302 connector on the main PBA.</p> <ul style="list-style-type: none"> ➢ When the door is open or before the cycle starts. ☐ Normal: 9.5 to 12.5 V ➢ After the cycle has started by closing the door and pressing the Power key. ☐ Normal: < 2 V 	<p>- Faulty: Replace the main PBA assy. - Remove Retainer. - Check voltage</p> 
		<p>4. Check the operation of the Power Relay : Start the cycle by pressing the Power Key. Measure the operation voltage between the terminal (black wire + black wire) of the Heater Relay and the terminal (yellow wire+ amber wire) of the Power Relay</p> <p>Caution Check the color of the wires of the Power Relay and the Heater Relay. ➢ Normal: 120V</p>	<p>- Faulty: Replace the power relay.</p> 

Trouble Shooting

Error Type	Error Mode	Checking Method	Corrective actions
Detergent is not dispensed.	None	1. Check whether detergent is inserted into the dispenser.	- Check whether there is detergent in the Dispenser.
		2. Check the connections for the Dispenser connector.	- Reconnect the Dispenser connector.
		3. Check the resistance of the Dispenser. (Remove the connector before measuring.) ➤ Normal: Approx. 2.3 kΩ	- Faulty: Replace the Dispenser. 
		4. Check the operation of the Dispenser Relay. Check the operating voltage between the white wire of the CN101 connector and the white wire of the CN201 connector. ➤ Normal: 120V (while operating)	- Faulty: Replace the Main PBA assy. - Remove Retainer.  - Check voltage 

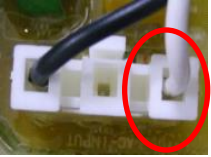
Trouble Shooting

Error Type	Error Mode	Checking Method	Corrective actions	
Dry is not satisfied.	None	1. Check whether Rinse Refill LED light or not.	- If Rinse Refill LED light, refill rinse in Dispenser.	
		2. Check the wire connections for the Fan Motor.	- Reconnect the Fan Motor connectors.	
		3. Check the resistance of the Fan Motor coil. (Remove the connector before measuring.) ➢ Normal: Approx. 150 Ω	- Faulty: Replace the Fan Motor assy.	
		4. Check the resistance of the Thermal Actuator. (Remove the connector before measuring.) ➢ Normal: Approx. 1.45 kΩ	- Faulty: Replace the Thermal Actuator.	
		5. Check the operation of the Fan Motor Relay : Check the operating voltage between the white wire of the C101 connector and the sky wire of the CN201 connector. ➢ Normal: 120V (while operating)	- Faulty: Replace the Main PBA assy. - Remove Retainer.	  - Check voltage  
		6. Check the operation of the dispenser. ➢ If rinse aids are not dispensed, a dry error may occur. ➢ Because the dishes are heated and heat dried during the last drying cycle, the dried state of plastic dishes may not be optimal.	- See "Detergent is not dispensed"	

Trouble Shooting

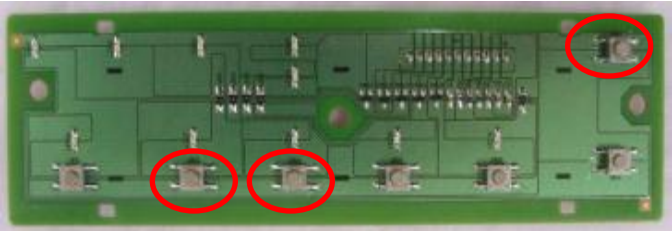
Error Type	Error Mode	Checking Method	Corrective actions
LED or Input Key Fail	None	1. Check the connections for the Sub PBA connector	- Reconnect the Sub PBA connectors..
		2. Check the LED and Input Key 1) Push 'Normal' + 'Heavy' + 'Power Key' 2) Push 'Normal' Key 4 times 3) Push all key except Start/Pause Key. ➤ Normal : All LED is light.	- Faulty : Replace the Sub PBA. 
		3. Check the DC voltage of the Main PBA.	- See "Main PBA DC voltage error".

Checkpoints after service request

1 Check the safety device

Check the operation of the door lock switch. Make sure that it is locked while the dishwasher is running and that it is unlocked when the dishwasher stops.

2. Use authenticated parts only

If any part is not authenticated, replace it with an authenticated part.

3. Handling wires

Check if any wires are loose or too tight, if they are connected correctly, if they are well bound with tape, and if they are properly clamped.

4. The state of screws and nuts

Check if the screws and nuts are fastened correctly.

Check whether they are fastened with the specified torque.

5. Remove foreign material

Check whether any foreign material such as soil, wire scraps and screws are in the dishwasher. (Check whether any foreign material is entering through the sump into the disposer.)

6. Check for water leakage

Check whether there is water leakage from the hose connector, door, case sump (drain motor, circulation motor, heater, thermistor, turbidity sensor, distributor motor), and the water supply/drain hoses.

7. Check the power cable

Check if there is any damage to the power cable or power outlet. Check that the power capacity is appropriate.

8. Check leveling

Check whether the dishwasher is level.

9. Check the installation location

Check whether the installation location is flat and stable.

Model Number Naming Rules

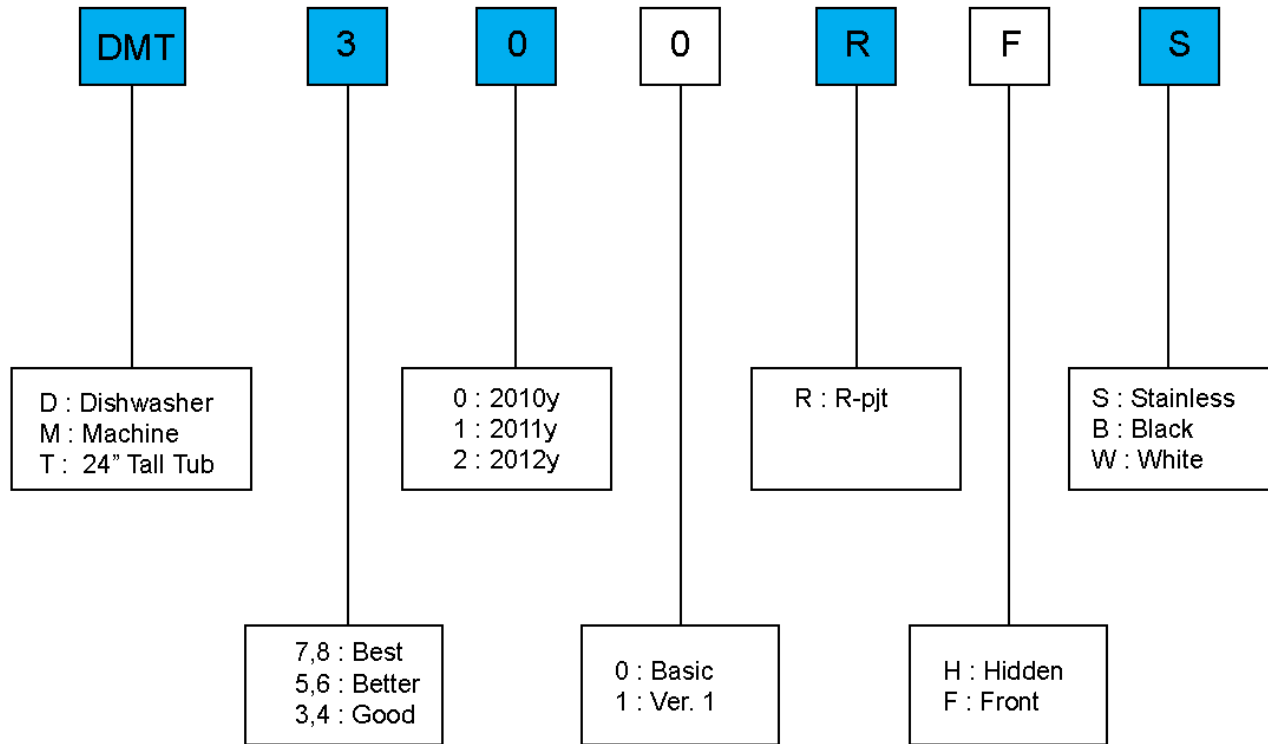

SAMSUNG

Thanks