

KitchenAid

TECHNICAL EDUCATION

KitchenAid Undercounter Refrigeration Suite



Wine Cellar

Models: KUWS24RSBS

KUWS24LSBS KUWS24RSSS

KUWO24RSBX KUWO24LSBX



Beverage Center

Models: KBCS24RSBS

KBCS24LSBS KBCS24RSSS

KBCO24RSBX KBCO24LSBX



Undercounter Refrigerator

Models: KURS24RSBS

KURS24LSBS KURS24RSSS

KURO24RSBX KURO24LSBX

FORWARD

This KitchenAid Job Aid, "Wine Cellar, Beverage Center & Undercounter Refrigerator" (Part No. xxxxxx), provides the technician with information on the installation, operation, and service of the Wine Cellar, Beverage Center & Undercounter Refrigerator. For specific information on the model being serviced, refer to the "Use and Care Guide," or "Tech Sheet" provided with the Wine Cellar, Beverage Center & Undercounter Refrigerator.

The Wiring Diagrams used in this Job Aid are typical and should be used for training purposes only. Always use the Wiring Diagram supplied with the product when servicing the unit.

GOALS AND OBJECTIVES

The goal of this Job Aid is to provide information that will enable the service technician to properly diagnose malfunctions and repair the Wine Cellar, Beverage Center & Undercounter Refrigerator.

The objectives of this Job Aid are to:

- Understand and follow proper safety precautions.
- Successfully troubleshoot and diagnose malfunctions.
- Successfully perform necessary repairs.
- Successfully return the product to its proper operational status.

In this job aid,
KitchenAid Undercounter Refrigeration Suite,
when differences occur between units,
the following abbreviations will be used:

Wine Cellar = UW
Beverage Center = BC
Undercounter Refrigerator = UR

WHIRLPOOL CORPORATION assumes no responsibility for any repairs made on our products by anyone other than Authorized Factory Service Technicians.

Copyright © 2006, Whirlpool Corporation, Benton Harbor, MI 49022

TABLE OF CONTENTS

Page

GENERAL	1-1
Wine Cellar, Beverage Center & Refrigerator Safety.....	1-1
Model Number Designations	1-2
Serial Number Designations	1-2
Model & Serial Number Label & Wiring Diagram Locations	1-3
Warranty	1-4
INSTALLATION INFORMATION	2-1
Tools and Parts	2-1
Location Requirements.....	2-1
Electrical Requirements.....	2-1
Unpack the Unit	2-2
Door Closing	2-2
Remove the Base Grille.....	2-3
THEORY OF OPERATION	3-1
General	3-1
Airflow	3-1
Ambient Thermostat (UW, BC)	3-1
Temperature Displays (UW, BC).....	3-1
COMPONENT ACCESS	4-1
Remove the Racks (UW, BC)	4-1
Remove the Tracks (UW, BC).....	4-2
Remove the Separator (UW, BC)	4-3
Remove the Evaporator Cover	4-4
Remove the Evaporator Fan and Motor	4-5
Remove the Main Thermostat (UW, BC)	4-6
Remove the Main Thermostat (UR).....	4-8
Wiring Connector Block	4-9
Remove the Defrost Heater	4-10
Remove the Defrost Thermostat and Thermal Fuse.....	4-11
Remove the Evaporator.....	4-12
Remove the Base Grille.....	4-13
Remove the Door Switch or the Light Switch	4-14
Accessing the Unit Compartment	4-15
Remove Defrost Timer.....	4-16
Unit Compartment Wire Connectors.....	4-17
Remove the Relay / Overload & Run Capacitors	4-18
Remove Drain Pan	4-19
Remove Condenser Fan.....	4-20
Remove Temperature Display Transformer	4-21
Remove Compressor.....	4-22
Remove Ambient Thermostat (UW, BC)	4-23
Remove Interior Light Bulb	4-24
Remove Door Switch Actuator (UW, BC).....	4-24

TABLE OF CONTENTS - CONTINUED

	Page
Remove the Door.....	4-25
Remove the Door Skin and Handle	4-25
Remove Door Gasket	4-26
Beverage Center Layout (BC)	4-26
Upper Compartment Temperature Display Thermistor Inside Evaporator Cover (BC).....	4-27
Disassemble Separator (UW, BC)	4-28
COMPONENT TESTING.....	5-1
Evaporator Fan Motor.....	5-1
Defrost Heater	5-1
Light Switches.....	5-2
Relay / Overload	5-2
Condenser Fan Motor	5-3
Temperature Display Transformer	5-3
Defrost Timer	5-4
Compressor	5-4
Ambient Thermostat (UW, BC)	5-5
Defrost Bimetal	5-5
DIAGNOSIS & TROUBLESHOOTING	6-1
The UW, BC, UR Will Not Operate	6-1
The Lights Do Not Work	6-1
There is Water in the Defrost Drain Pan	6-1
The Motor Seems to Run Too Much	6-1
Temperature is Too Warm.....	6-2
There is Interior Moisture Buildup.....	6-2
The Door is Difficult to Open.....	6-2
The Door Will Not Close Completely	6-2
WIRING DIAGRAMS.....	7-1
Wine Cellar Wiring Diagram	7-1
Beverage Center Wiring Diagram.....	7-2
Undercounter Refrigerator Wiring Diagram	7-3

GENERAL

WINE CELLAR, BEVERAGE CENTER & REFRIGERATOR SAFETY

Your safety and the safety of others are very important.

We have provided many important safety messages in this manual and on your appliance. Always read and obey all safety messages.



This is the safety alert symbol.

This symbol alerts you to potential hazards that can kill or hurt you and others.

All safety messages will follow the safety alert symbol and either the word "DANGER" or "WARNING." These words mean:

⚠ DANGER

You can be killed or seriously injured if you don't immediately follow instructions.

⚠ WARNING

You can be killed or seriously injured if you don't follow instructions.

All safety messages will tell you what the potential hazard is, tell you how to reduce the chance of injury, and tell you what can happen if the instructions are not followed.

MODEL NUMBER DESIGNATIONS

MODEL NUMBER	K	BC	S	24	R	S	BS	0
BRAND								
K = KITCHENAID								
PRODUCT GROUP								
UR = UNDERCOUNTER REFRIGERATOR								
UW = WINE CELLAR								
BC = BEVERAGE CENTER								
PRODUCT IDENTIFICATION								
S = SUPERBA								
O = OVERLAY MODEL								
WIDTH								
24 = 24" WIDE								
DOOR SWING								
R = RIGHTHAND DOOR								
L = LEFTHAND DOOR								
YEAR OF INTRODUCTION								
S = 2006								
T = 2007								
V = 2008								
COLOR								
BS = STAINLESS DOOR, BLACK CABINET								
SS = STAINLESS DOOR, STAINLESS CABINET								
BX = OVERLAY DOOR, BLACK CABINET								
ENGINEERING CHANGE								
0, 1, 2, ETC.								

SERIAL NUMBER DESIGNATIONS

SERIAL NUMBER	EK	T	12	12345
ENGINEERING RESPONSIBILITY				
EK = EVANSVILLE, IN				
YEAR OF PRODUCTION				
T = 2006				
U = 2007				
WEEK OF PRODUCTION				
12 = 12th week of the year				
PRODUCT SEQUENCE NUMBER				

MODEL & SERIAL NUMBER LABEL & WIRING DIAGRAM LOCATIONS



**Model & Serial Number Label Location
(On Upper Right Side of Liner)**

Wiring Diagram



WARRANTY

KITCHENAID® REFRIGERATOR WARRANTY

ONE YEAR LIMITED WARRANTY

For one year from the date of purchase, when this major appliance is operated and maintained according to instructions attached to or furnished with the product, KitchenAid or KitchenAid Canada (hereafter "KitchenAid") will pay for factory specified parts and repair labor to correct defects in materials or workmanship. Service must be provided by a KitchenAid designated service company.

SECOND THROUGH FIFTH YEAR LIMITED WARRANTY ON CAVITY LINER AND SEALED REFRIGERATION SYSTEM PARTS AS LISTED

In the second through fifth years from the date of purchase, when this refrigerator is operated and maintained according to instructions attached to or furnished with the product, KitchenAid will pay for replacement or repair of the refrigerator/freezer cavity liner (including labor costs) if the part cracks due to defective materials or workmanship. Also, in the second through fifth years from the date of purchase, KitchenAid will pay for factory specified parts and labor to correct defects in materials or workmanship in the sealed refrigeration system. These parts are: compressor, evaporator, condenser, dryer, and connecting tubing. Service must be provided by a KitchenAid designated service company.

ITEMS KITCHENAID WILL NOT PAY FOR

1. Service calls to correct the installation of your major appliance, to instruct you how to use your major appliance, to replace or repair house fuses or to correct house wiring or plumbing.
2. Service calls to repair or replace appliance light bulbs, air filters or water filters. Those consumable parts are excluded from warranty coverage.
3. Repairs when your major appliance is used for other than normal, single-family household use.
4. Damage resulting from accident, alteration, misuse, abuse, fire, flood, acts of God, improper installation, installation not in accordance with electrical or plumbing codes, or use of products not approved by KitchenAid.
5. Any food loss due to refrigerator or freezer product failures.
6. Replacement parts or repair labor costs for units operated outside the United States or Canada.
7. Pickup and delivery. This major appliance is designed to be repaired in the home.
8. Repairs to parts or systems resulting from unauthorized modifications made to the appliance.
9. Expenses for travel and transportation for product service in remote locations.
10. The removal and reinstallation of your appliance if it is installed in an inaccessible location or is not installed in accordance with published installation instructions.

DISCLAIMER OF IMPLIED WARRANTIES; LIMITATION OF REMEDIES

CUSTOMER'S SOLE AND EXCLUSIVE REMEDY UNDER THIS LIMITED WARRANTY SHALL BE PRODUCT REPAIR AS PROVIDED HEREIN. IMPLIED WARRANTIES, INCLUDING WARRANTIES OF MERCHANTABILITY OR FITNESS FOR A PARTICULAR PURPOSE, ARE LIMITED TO ONE YEAR OR THE SHORTEST PERIOD ALLOWED BY LAW. KITCHENAID SHALL NOT BE LIABLE FOR INCIDENTAL OR CONSEQUENTIAL DAMAGES. SOME STATES AND PROVINCES DO NOT ALLOW THE EXCLUSION OR LIMITATION OF INCIDENTAL OR CONSEQUENTIAL DAMAGES, OR LIMITATIONS ON THE DURATION OF IMPLIED WARRANTIES OF MERCHANTABILITY OR FITNESS, SO THESE EXCLUSIONS OR LIMITATIONS MAY NOT APPLY TO YOU. THIS WARRANTY GIVES YOU SPECIFIC LEGAL RIGHTS AND YOU MAY ALSO HAVE OTHER RIGHTS, WHICH VARY FROM STATE TO STATE OR PROVINCE TO PROVINCE.

Outside the 50 United States and Canada, this warranty does not apply. Contact your authorized KitchenAid dealer to determine if another warranty applies.

If you need service, first see the "Troubleshooting" section of the Use & Care Guide. After checking "Troubleshooting," additional help can be found by checking the "Assistance or Service" section or by calling KitchenAid. In the U.S.A., call **1-800-422-1230**. In Canada, call **1-800-807-6777**.

1/06

Keep this book and your sales slip together for future reference. You must provide proof of purchase or installation date for in-warranty service.

Write down the following information about your major appliance to better help you obtain assistance or service if you ever need it. You will need to know your complete model number and serial number. You can find this information on the model and serial number label located on the product.

Dealer name _____

Address _____

Phone number _____

Model number _____

Serial number _____

Purchase date _____

INSTALLATION INFORMATION

TOOLS AND PARTS

Gather the required tools and parts before starting installation.

- Phillips screwdriver

LOCATION REQUIREMENTS

⚠ WARNING



Explosion Hazard

Keep flammable materials and vapors, such as gasoline, away from beverage center.

Failure to do so can result in death, explosion, or fire.

To ensure proper ventilation for the UW, BC & UR, allow for a 1/4" (6.35 mm) space on each side and at the top. When installing next to a fixed wall, leave 2 1/2" (6.35 cm) minimum clearance on each side to allow for the door to swing open.

NOTE: It is recommended that you do not install near an oven, radiator, or other heat source. Do not install in a location where the temperature will fall below 55°F (13°C). For best performance, do not install behind a cabinet door or block the base grille.

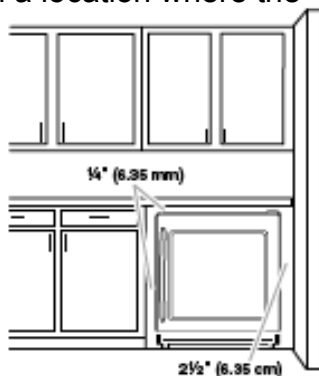

ELECTRICAL REQUIREMENTS

⚠ WARNING



Electrical Shock Hazard

Disconnect power before servicing. Replace all parts and panels before operating. Failure to do so can result in death or electrical shock.

Before you move the UW, BC or UR into its final location, it is important to make sure you have the proper electrical connection.

Recommended grounding method
A 115 Volt, 60 Hz., AC only 15– or 20–amp fused, grounded electrical supply is required. It is recommended that a separate circuit serving only the unit be provided. Use an outlet that cannot be turned off by a switch. Do not use an extension cord.

NOTE: Before performing any type of installation, cleaning, or removing a light bulb, unplug unit or disconnect power.

UNPACK THE UNIT

⚠ WARNING

Excessive Weight Hazard

Use two or more people to move and install beverage center.

Failure to do so can result in back or other injury.

- Remove the Packaging. Remove tape and glue residue from surfaces before turning on the unit. Rub a small amount of liquid dish soap over the adhesive with your fingers. Wipe with warm water and dry.
- Do not use sharp instruments, rubbing alcohol, flammable fluids, or abrasive cleaners to remove tape or glue. These products can damage the surface of the unit.
- Dispose of / recycle all packaging materials.
- When Moving the Unit: The unit is heavy. When moving the appliance for service, be sure to protect the floor. Always pull the appliance straight out when moving it. Do not wiggle or “walk” the appliance when trying to move it, as floor damage could occur.
- Clean Before Using: After you remove all of the packaging materials, clean the inside of the unit before using it.

DOOR CLOSING

The UW, BC or UR has four leveling legs. If it seems unsteady or you want the door to close more easily, adjust the tilt using the instructions below.

⚠ WARNING



Electrical Shock Hazard

Plug into a grounded 3 prong outlet.

Do not remove ground prong.

Do not use an adapter.

Do not use an extension cord.

Failure to follow these instructions can result in death, fire, or electrical shock.

1. Plug into a grounded 3 prong outlet.

⚠ WARNING

Excessive Weight Hazard

Use two or more people to move and install beverage center.

Failure to do so can result in back or other injury.

2. Move the UW, BC or UR into its final location.
3. Turn the leveling legs to the right to lower the unit or turn the leveling legs to the left to raise it. It may take several turns of the leveling legs to adjust the tilt of the unit. **NOTE:** Having someone push against the top of the unit takes some weight off the leveling legs. This makes it easier to adjust the leveling legs.
4. Open the door and check to make sure that it closes as easily as you like. If not, tilt the unit slightly more to the rear by turning both front leveling screws to the right. It may take several more turns, and you should turn both leveling legs the same amount.

REMOVE THE BASE GRILLE

1. Open the unit door.
2. Using a Phillips screwdriver, remove the two screws. Push both tabs in toward the center to release the base grille from the unit.

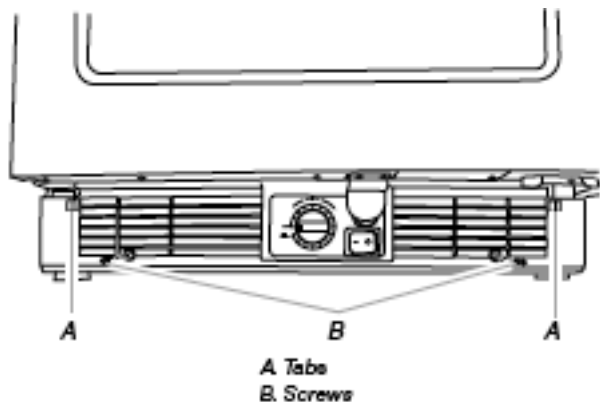

3. Remove the base grille.

REPLACE THE BASE GRILLE

1. Open the unit door.
2. Position the base grille so that both tabs align and the base grille snaps into place. Replace the two screws. Tighten the screws.

— NOTES —

THEORY OF OPERATION

GENERAL

There are three variations of one core platform available: a wine cellar, a beverage center and an all refrigerator. All units share the same basic cooling system with only slight differences in airflow inside the cabinet. The fan forced evaporator is frost-free, using a conventional compressor run defrost timer, defrost heater, defrost bimetal and thermal fuse. All three units use a single mechanical cold control.

UW/BC: On the beverage center and wine cellar the separate temperature zones are maintained through the amount of airflow to each zone. On these units the thermostat tube is coiled in the evaporator compartment, on the right-hand side above the evaporator. The thermostat bulb on the wine cellar and beverage center is coiled on the right side above the evaporator. UR: The thermostat bulb on the all-refrigerator is coiled in the lower right corner below the evaporator. The thermostat bulb is the cold control's sensing point that determines run time.

AIRFLOW

The UR has one temperature zone. The UW has two temperature zones and the BC has three temperature zones. It is important to remember that on the BC & UW, the coldest zone will be at the top and the warmest zone at the bottom. This is due to the fan forced evaporator airflow pattern. Airflow from the evaporator is first directed into the top of the compartment. The bottom zone on the BC and UW, is cooled primarily by conduction and to a smaller degree, air migration past the separator. The middle zone on the BC is cooled from a small amount of air migrating from the top zone. The warm air return is located approximately in the center of the evaporator cover on all models.

AMBIENT THERMOSTAT (UW, BC)

The beverage center and wine cellar have a 7 watt liner heater located just under the liner in the bottom of the lower compartment. An ambient thermostat mounted above the compressor controls the heater. The ambient thermostat bulb is routed into the bottom of the cooling compartment. The thermostat closes to energize the heater if the lower zone gets too cold. The ambient thermostat is not adjustable.

TEMPERATURE DISPLAYS (UW, BC)

The beverage center and wine cellars have a temperature display for each zone. 12 volts AC is supplied to the display board from a transformer in the unit compartment. The displays are only temperature displays and have nothing to do with any cooling function. A thermistor is used to sense temperature for each zone. The thermistor for the bottom zone is located inside the lower portion of the separator. The thermistor for the top zone on the wine cellar, (mid zone on beverage center), is located in the upper portion of the separator. The thermistor for the beverage center upper zone is located on the inside of the 2-piece evaporator cover. It is on the right-hand side.

The mid temperature for the bottom zones on either unit are 60° Fahrenheit plus or minus 5 degrees. The mid temperature for the mid zone on the beverage center and the top zone on the wine cellar is 45° Fahrenheit plus or minus 5 degrees. The mid temperature for the top zone on the beverage center is 38° Fahrenheit plus or minus 5 degrees.

— NOTES —

COMPONENT ACCESS

REMOVE THE RACKS (UW, BC)

⚠ WARNING



Electrical Shock Hazard
Disconnect power before servicing.
Replace all parts and panels before operating.
Failure to do so can result in death or electrical shock.

1. Open the door



2. Slide one of the racks out until it stops

3. Press the release lever on each side and slide the rack out of the tracks.



4. The bottom rack does not slide on tracks. To remove the bottom rack, lift the rear edge of the rack to move the rubber stop over the stop at the back left corner of the unit and pull the rack out of the unit.



REMOVE THE TRACKS (UW, BC)

1. To remove the tracks, lift the front end of the track and pull the hooked end out of the slot in the wall.

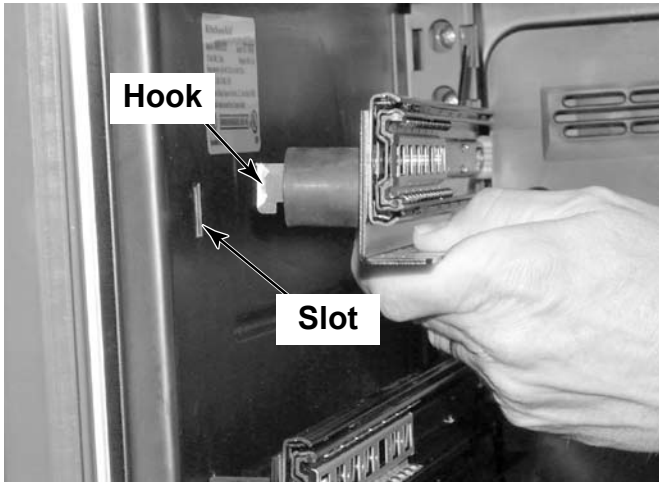

2. Lift the back of the track and pull to release the hooks on the track from the slots in the back of the unit. Remove the track from the unit.

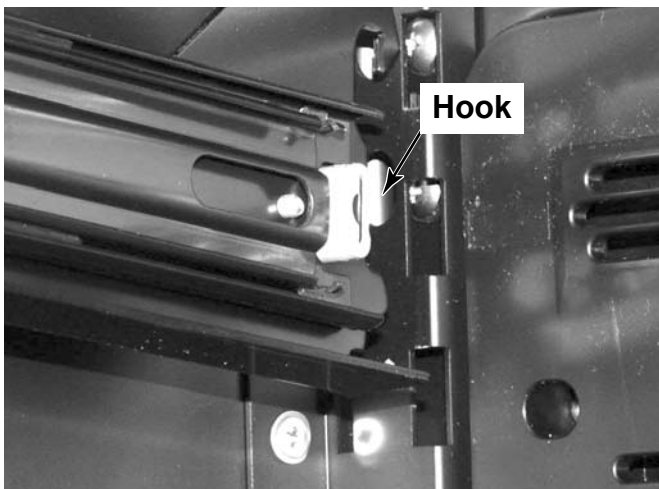

3. Lay the tracks in order of removal to assist in reassembly. There are two different tracks for different positions in the unit, and the tracks from the left side and right side are different. Make sure that the track with the narrow spacing is installed in the lowest position of the unit.

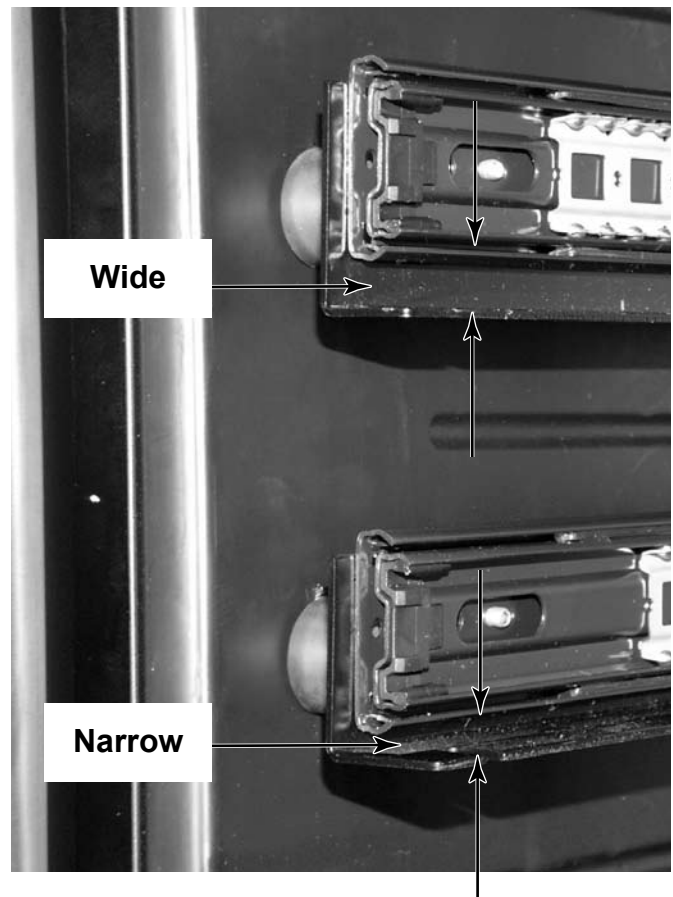

REMOVE THE SEPARATOR (UW, BC)

⚠ WARNING



Electrical Shock Hazard
Disconnect power before servicing.
Replace all parts and panels before operating.
Failure to do so can result in death or electrical shock.

1. Locate the adhesive squares below the separator that cover the wires and connector. Remove the adhesive squares carefully so they can be reused during reassembly.

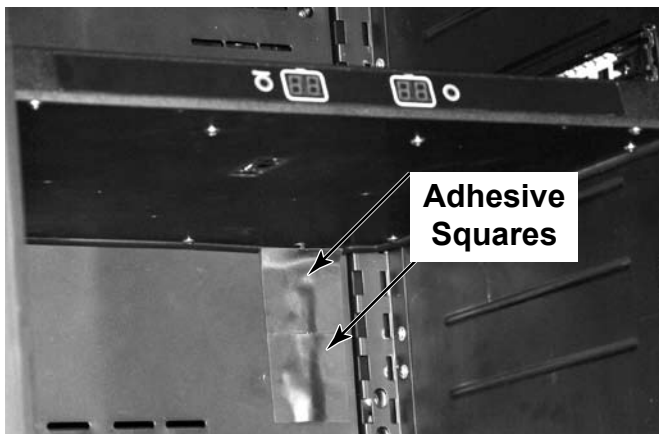

2. Disconnect the wire connector from the back of the unit by pressing the locking tab and pulling it out. (The Beverage Center will have two connectors at the back of the unit.)

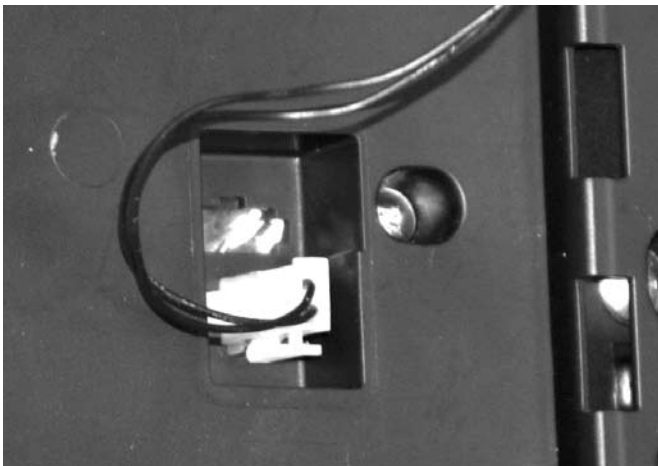

3. Remove the two screws, one at each side, that secure the separator to the unit.

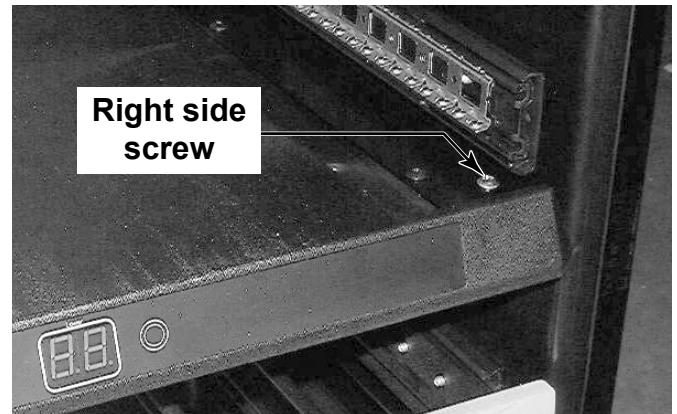

4. To remove the separator, grasp the front edge with both hands and pull to release the separator and remove it from the unit.

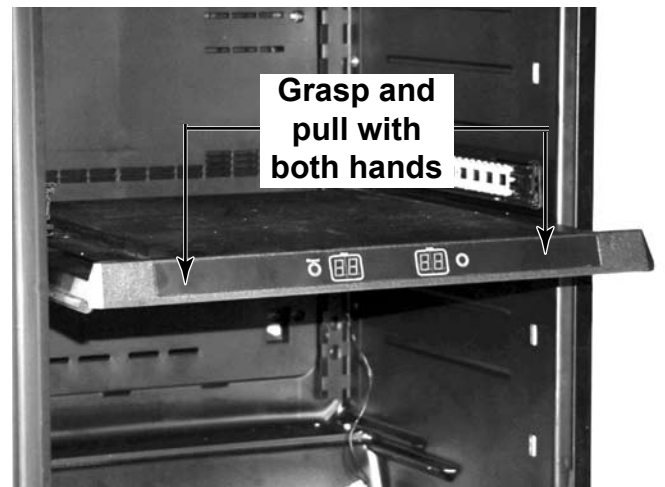

5. Remove the last two rack tracks that support the separator.

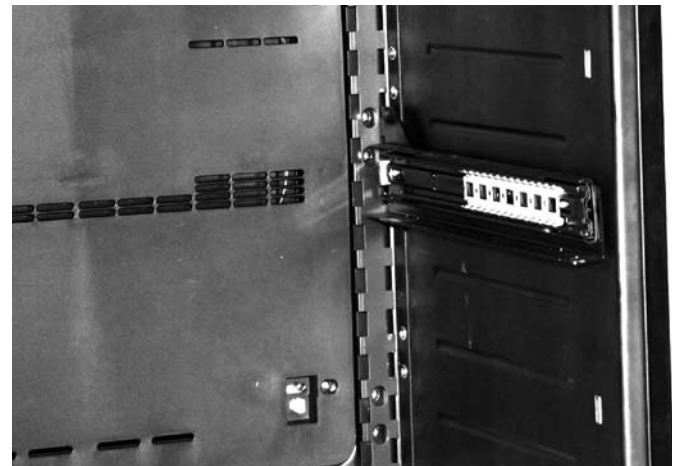

REMOVE THE EVAPORATOR COVER

⚠ WARNING



Electrical Shock Hazard
Disconnect power before servicing.
Replace all parts and panels before operating.
Failure to do so can result in death or electrical shock.



1. Remove the racks. (See page 4-1)
2. Remove the tracks. (See page 4-2)
3. UW / BC: Remove the separator. (See page 4-3)
4. Remove the six screws that secure the evaporator cover to the unit.

6. To remove the cover completely, disconnect the connectors from the back of the unit. The evaporator fan connector is on the left, the separator display on UW / BC is on the right, and one ground wire from the evaporator is on the right on all models. (See page 4-9)

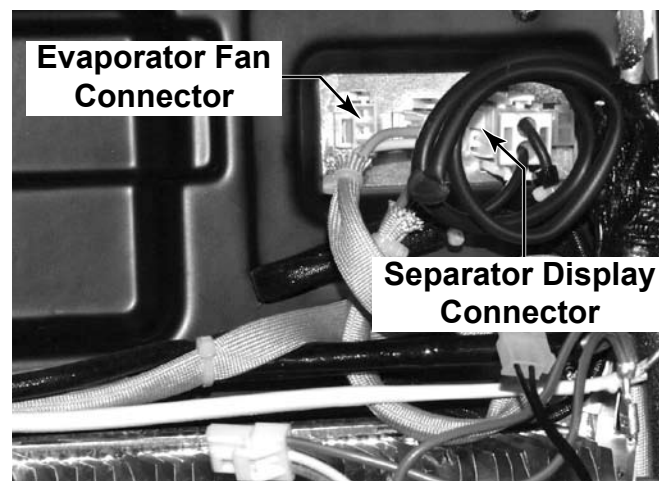
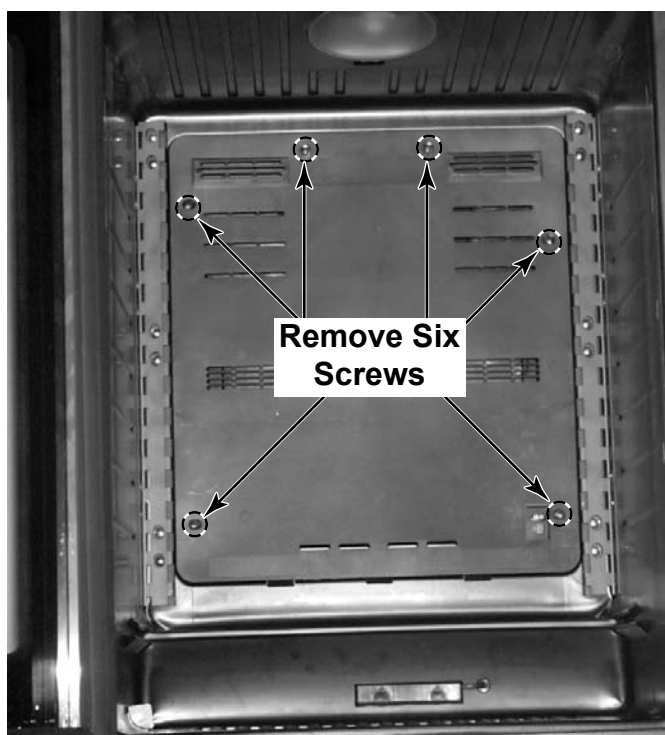

5. Pull the cover away from the evaporator and turn it to the side to gain access to the components behind the cover.

7. Components accessible with the evaporator cover removed are:

- Evaporator Fan & Motor (Page 4-5)
- Main thermostat (Pages 4-6, 4-7 & 4-8)
- Defrost heater (Page 4-9)
- Defrost thermostat & thermal fuse (Page 4-10)
- Evaporator (Page 4-11)

REMOVE THE EVAPORATOR FAN AND MOTOR

⚠ WARNING



Electrical Shock Hazard
Disconnect power before servicing.
Replace all parts and panels before operating.
Failure to do so can result in death or electrical shock.

1. Remove the Evaporator cover. (See page 4-4)
2. Disconnect three spade wire connectors from the evaporator fan, two power connectors and one ground connector.
3. Remove the two screws that secure the evaporator fan bracket to the evaporator cover. A second ground wire is also secured with one of these screws.

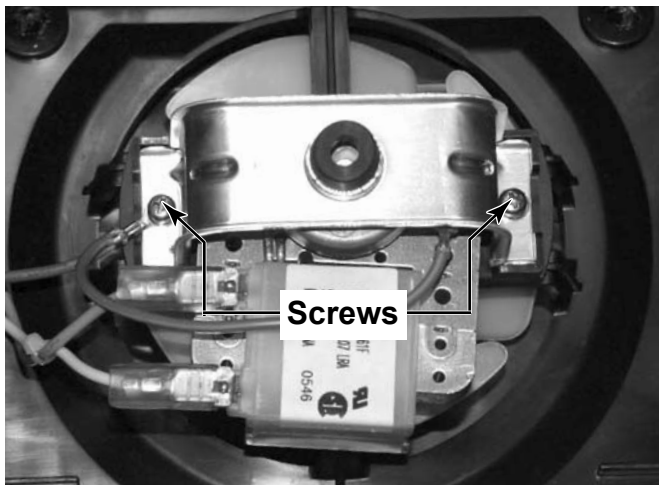

4. After removing the wires and bracket, pull the motor shaft out of the fan blade to remove the motor.

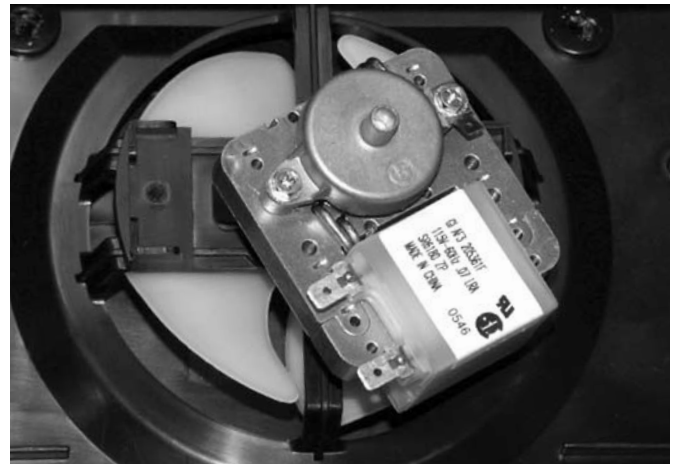

5. Be sure to reinstall the rubber grommets into the brackets

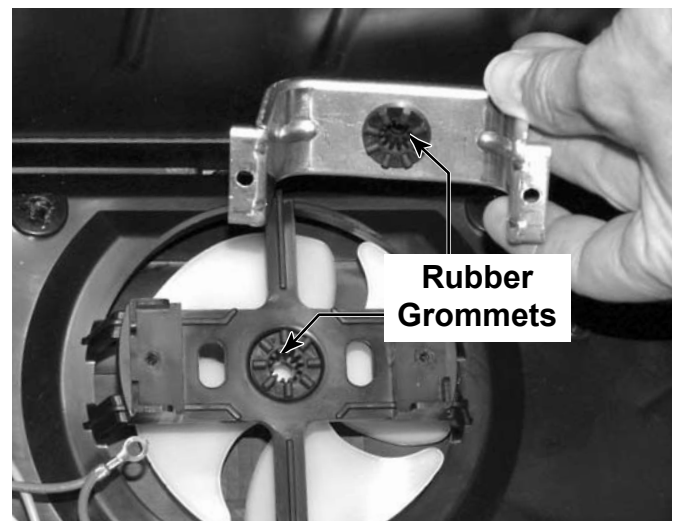

6. When reassembling the motor to the fan, push the shaft of the motor through the hole of the fan blade until the shaft is flush with the front of the fan. Be sure to reinstall both the ground wires removed earlier.

REMOVE THE MAIN THERMOSTAT (UW, BC)

⚠ WARNING



Electrical Shock Hazard
Disconnect power before servicing.
Replace all parts and panels before operating.
Failure to do so can result in death or electrical shock.

1. The main thermostat adjustment knob, door switch and rocker light switch are in the center of the lower front grill. (The Undercounter Refrigerator does not have the rocker light switch.)

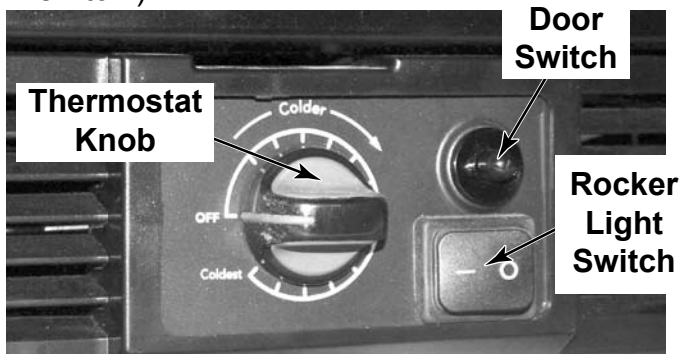

2. The main thermostat bulb, in the Wine Cellar and Beverage Center, is located above the evaporator in the right hand corner. It has 2 1/2 coils of wire at the top.



3. To remove the main thermostat, begin by removing the evaporator cover. (See page 4-4)

4. Carefully work the bulb out from behind the wires and tubing. The thermostat bulb runs down the right side of the evaporator and is protected with an insulated sleeve. Pull the bulb out from beside the evaporator. Take careful note of the positioning of the bulb and insulating sleeve for proper reinstallation, otherwise the thermostat may be adversely affected by the evaporator.

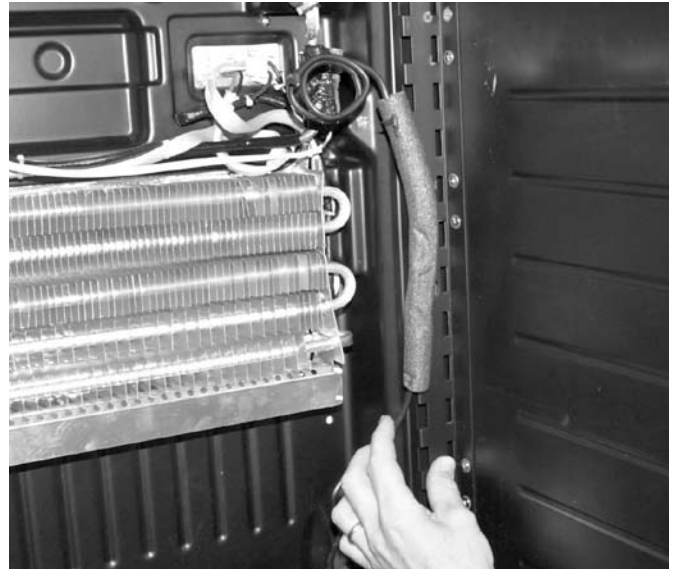

5. The thermostat bulb runs through the interior liner and is sealed in place with a mastic sealant around the bulb. Be sure to replace the sealant when reinstalling the thermostat to seal the hole from leaking cold air.



6. Pull the thermostat bulb through the liner into the component compartment from the back of the unit.

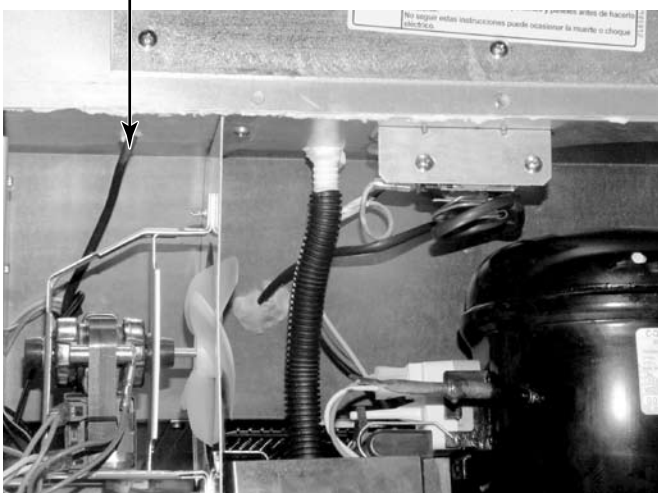

10. Remove the control knob. Remove the thermostat control by rotating the back of the thermostat up and out of the control box.

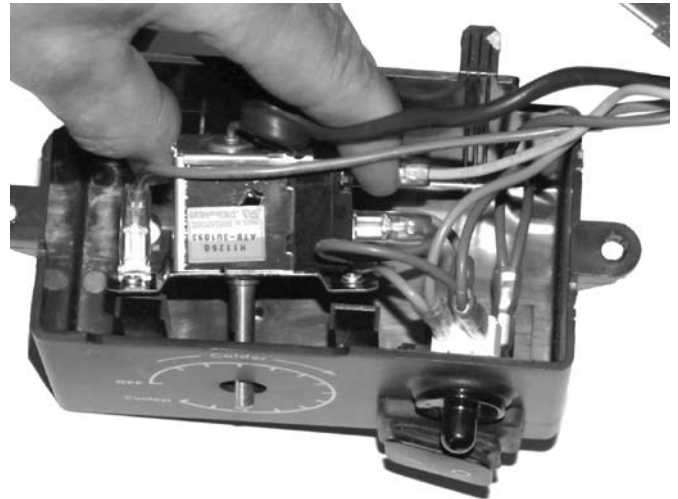

7. Remove the base grill. (See page 4-13)

8. Remove the two screws that secure the Control box to the bottom of the unit.

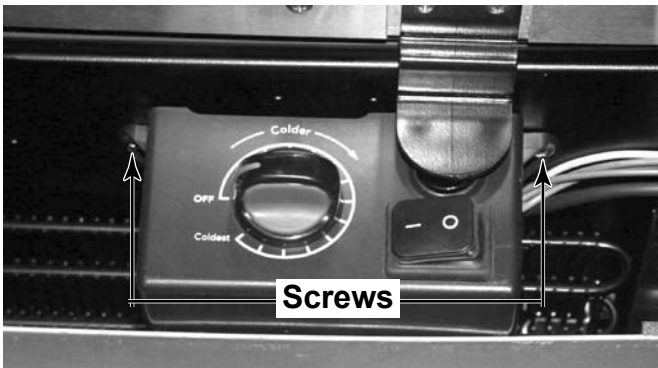

9. Lower the front of the control box and slide the rear tabs out of the slots that hold the back of the control box.

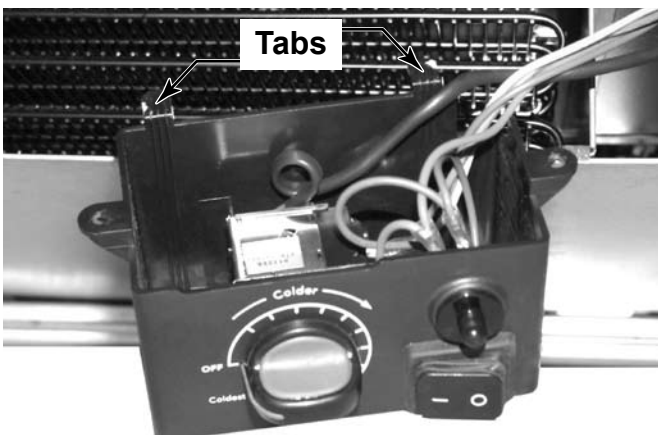

REMOVE THE MAIN THERMOSTAT (UR)

⚠ WARNING



Electrical Shock Hazard
Disconnect power before servicing.
Replace all parts and panels before operating.
Failure to do so can result in death or electrical shock.

1. The main thermostat bulb in the Undercounter Refrigerator is located in the lower right hand corner behind the evaporator cover. It is a single loop.

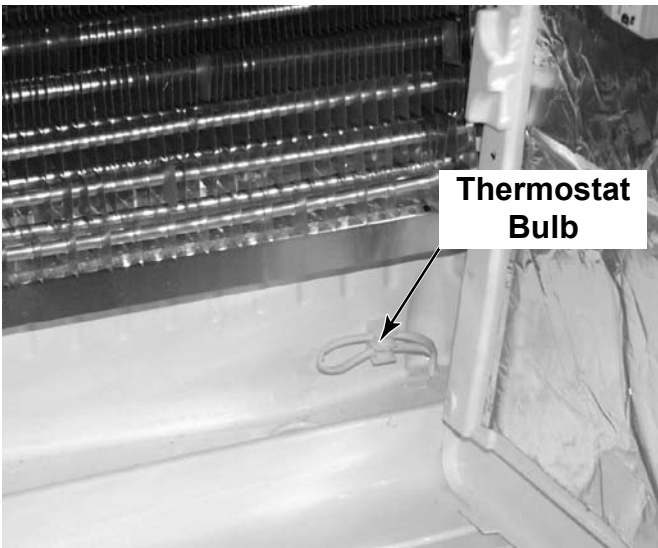

2. To remove this thermostat, first remove the evaporator cover. (See page 4-4)
3. The thermostat bulb runs through the interior liner and is sealed in place with a mastic sealant around the bulb. Be sure to replace the sealant when reinstalling the thermostat to seal the hole from leaking cold air.

4. Pull the thermostat bulb through the liner into the component compartment from the back of the unit.

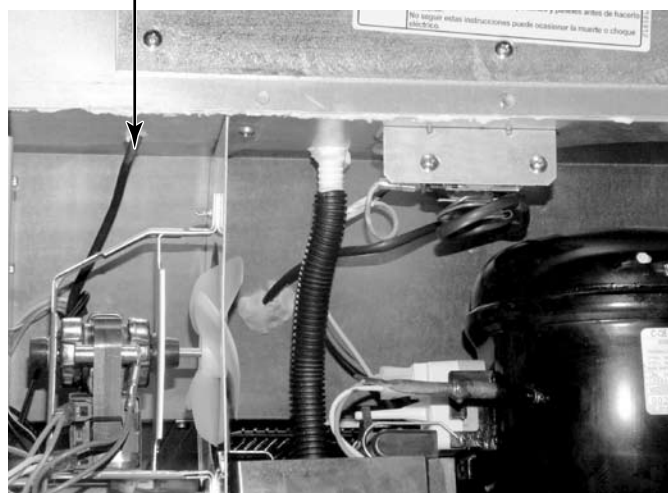

5. Remove the base grill. (See page 4-13)

6. Remove the two screws that secure the Control box to the bottom of the unit.

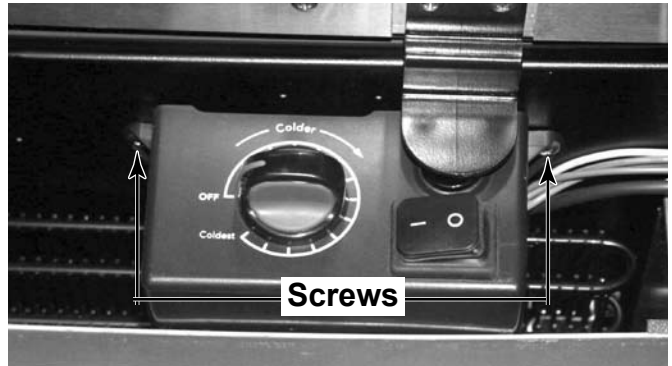

7. Lower the front of the control box and slide the rear tabs out of the slots that hold the back of the control box.

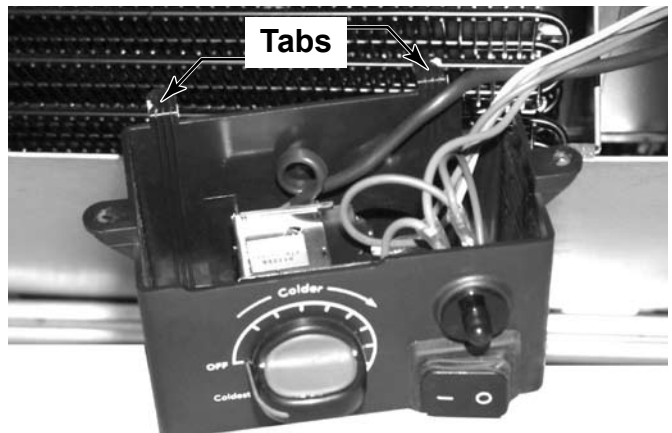

REMOVE THE DEFROST HEATER

⚠ WARNING



Electrical Shock Hazard
Disconnect power before servicing.
Replace all parts and panels before operating.
Failure to do so can result in death or electrical shock.

The defrost heater is located behind the evaporator cover just below the evaporator. It is protected with a metal shield. Be careful not to touch the glass tubed element with bare hands. Oils from your skin can shorten the life of the element.

1. Remove the evaporator cover. (See page 4-4)

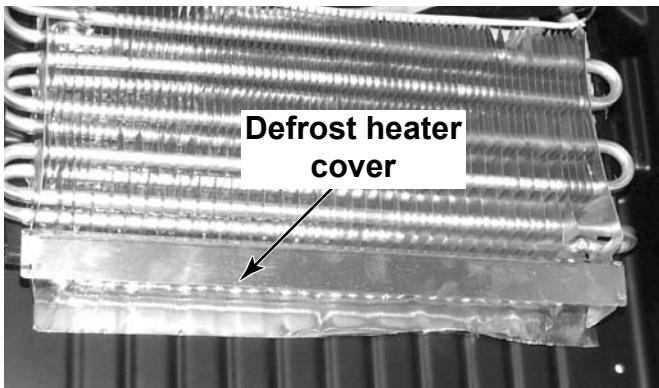

2. Remove the defrost heater cover by carefully straightening the two bent metal tabs at each end with needle nose pliers. Pull the cover toward you.

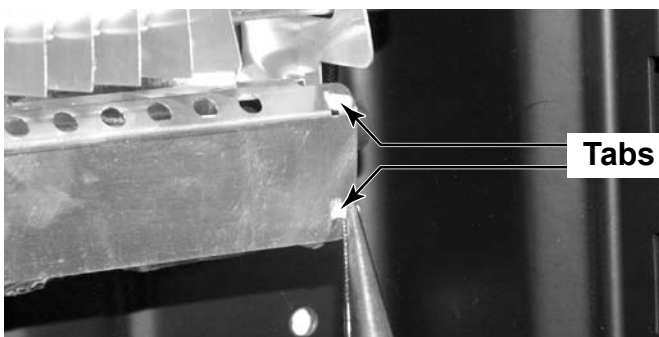

3. Locate the wire ties securing the defrost heater wires around the evaporator. Cut the two wire ties on the top and two on the right side of the evaporator. Note the location of the wire ties and the routing of the wires for proper replacement during reassembly.

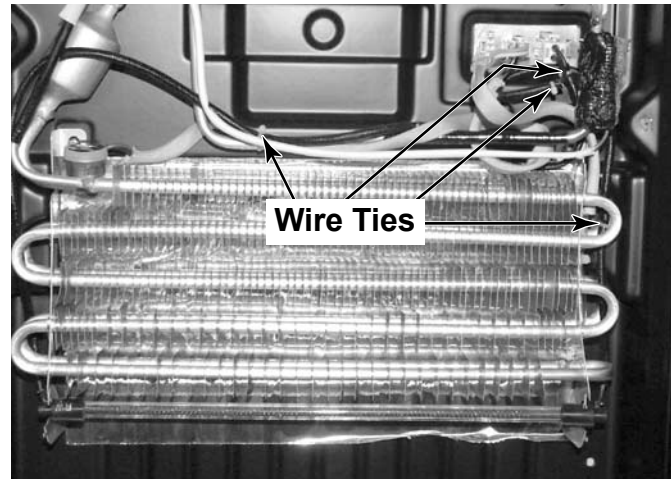

4. Disconnect the wire connector to the defrost heater from the connector block in position 3 (See page 4-9)
5. Carefully move the wires to the defrost heater out from around the evaporator.
6. Remove the defrost heater element by sliding it out of the slots at each end.

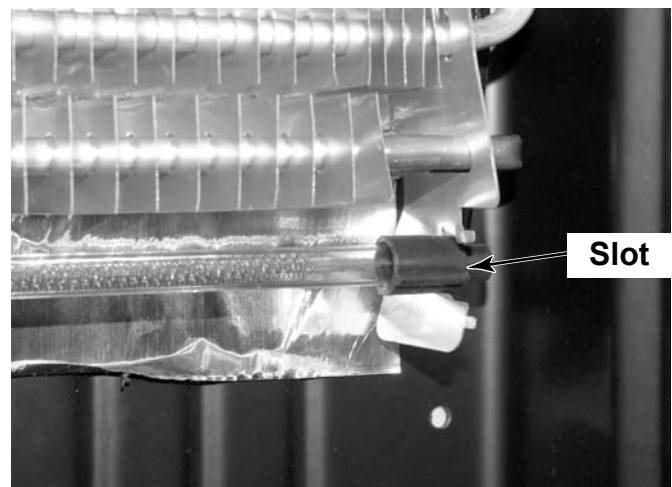

REMOVE THE DEFROST THERMOSTAT AND THERMAL FUSE

! WARNING



Electrical Shock Hazard
Disconnect power before servicing.
Replace all parts and panels before operating.
Failure to do so can result in death or electrical shock.

1. To Remove the defrost thermostat and thermal fuse, begin by removing the evaporator cover (See page 4-4).
2. Unclip the metal bracket that secures the thermostat to the top left of the evaporator.

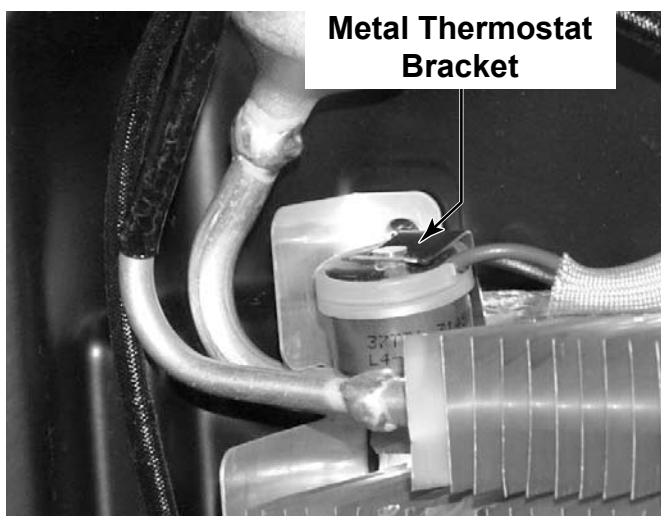

3. Carefully remove the thermal fuse at the right side of the evaporator.

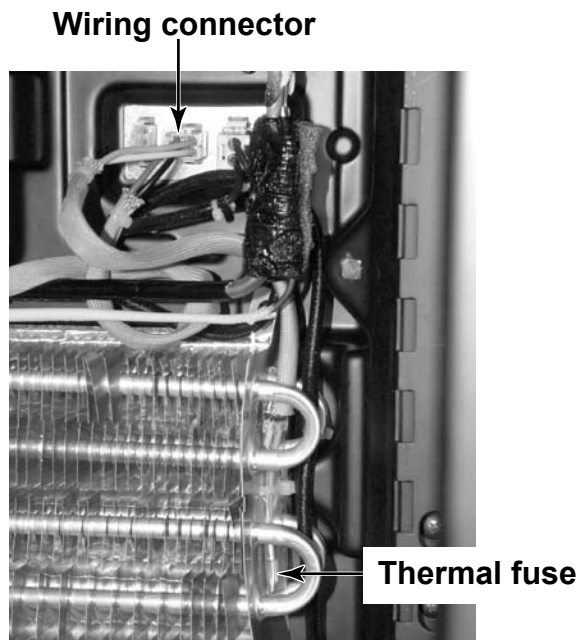

4. Disconnect the wiring connector from the wiring connector block at position 2. (See page 4-9) The thermostat and thermal fuse are connected to the same harness and are removed together.



REMOVE THE EVAPORATOR

⚠ WARNING



Electrical Shock Hazard
Disconnect power before servicing.
Replace all parts and panels before operating.
Failure to do so can result in death or electrical shock.

1. Remove the evaporator cover. (See page 4-4)
2. Remove the evaporator fan and motor. (See page 4-5)
3. Remove the main thermostat. (See pages 4-6 & 4-7 or 4-8)
4. Remove the defrost heater and cover. (See page 4-10)
5. Remove the defrost thermostat & thermal fuse. (See page 4-11)

6. Remove the evaporator by removing the two screws that secure the evaporator to the back wall of the unit. (Photo show screws already removed so the brackets could be seen better.)



7. Access the sealed system and discharge the refrigerant into an approved recovery system.
8. Unbrazed the suction and discharge lines and remove the evaporator from the unit.

REMOVE THE BASE GRILLE

⚠ WARNING



Electrical Shock Hazard
Disconnect power before servicing.
Replace all parts and panels before operating.
Failure to do so can result in death or electrical shock.

1. Open the unit door.
2. Using a Phillips screwdriver, remove the two screws that secure the base grille to the unit.

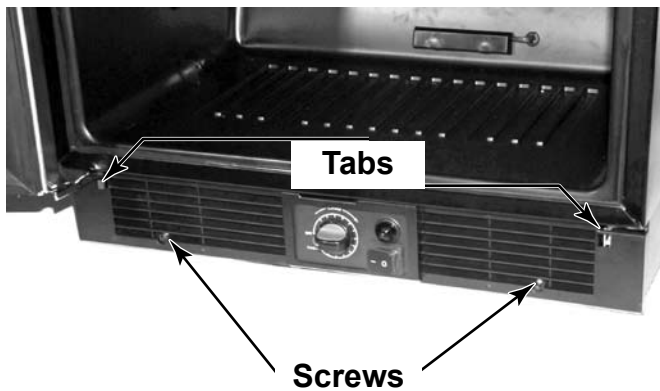

3. Push both tabs in toward the center to release the base grille from the unit.

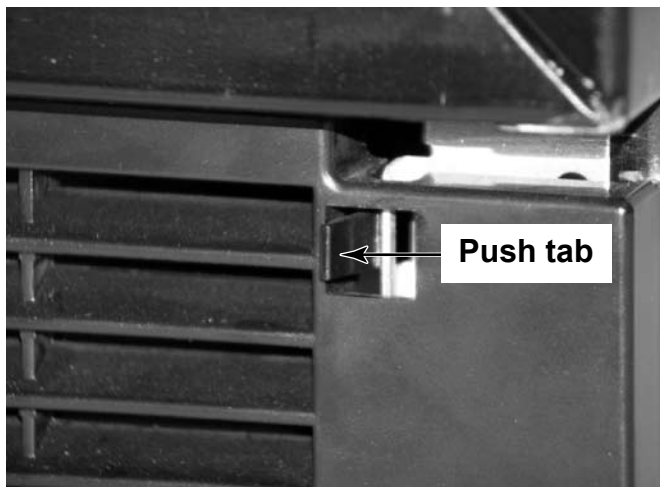

4. Remove the base grille.
5. Components accessible with the base grille removed are:
 - Condenser
 - Thermostat control
 - Door switch
 - Rocker light switch (not included on the Undercounter refrigerator)

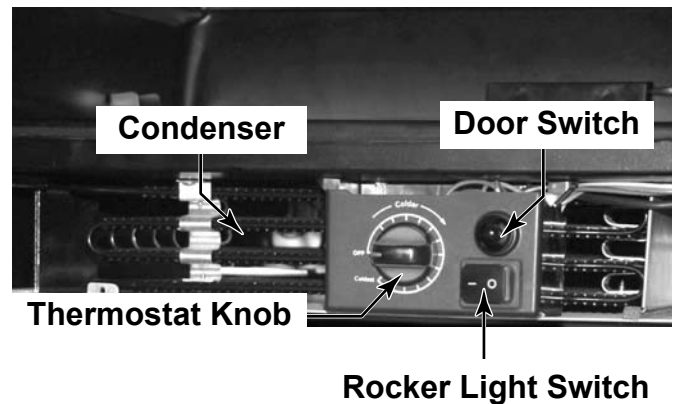

REMOVE THE DOOR SWITCH OR THE LIGHT SWITCH

⚠ WARNING



Electrical Shock Hazard
Disconnect power before servicing.
Replace all parts and panels before operating.
Failure to do so can result in death or electrical shock.

1. Remove the base grille (See page 4-13)
2. Remove the two screws that secure the Control box to the bottom of the unit.

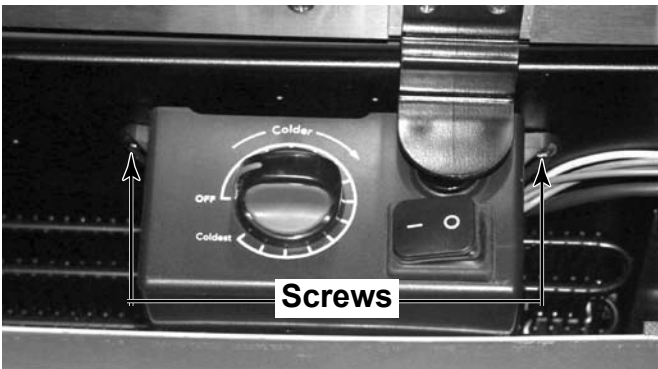

3. Lower the front of the control box and slide the rear tabs out of the slots that hold the back of the control box.

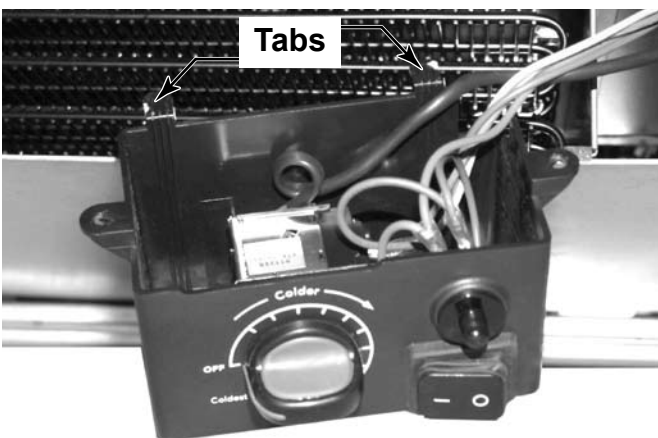

4. Disconnect the wire connectors attached to the switch.

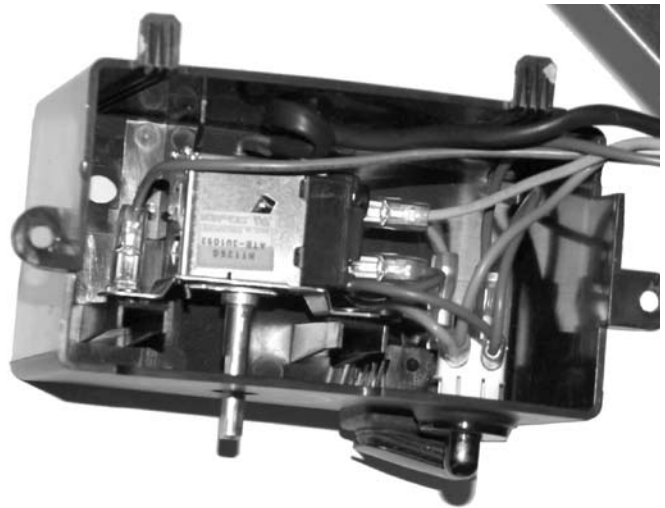

5. Press in on the tabs on the switch body and push the switch out of the hole in the control box.



ACCESSING THE UNIT COMPARTMENT

⚠ WARNING



Electrical Shock Hazard
Disconnect power before servicing.
Replace all parts and panels before operating.
Failure to do so can result in death or electrical shock.

1. Remove the seven screws that attach the access panel to the rear of the unit

2. Components accessible with the component cover removed are:

- 1. Defrost Timer
- 2. Condenser Fan Motor
- 3. Ambient Thermostat
- 4. Relay / Overload
- 5. Run Capacitor
- 6. Compressor
- 7. Filter / Drier
- 8. Temperature Display Transformer.

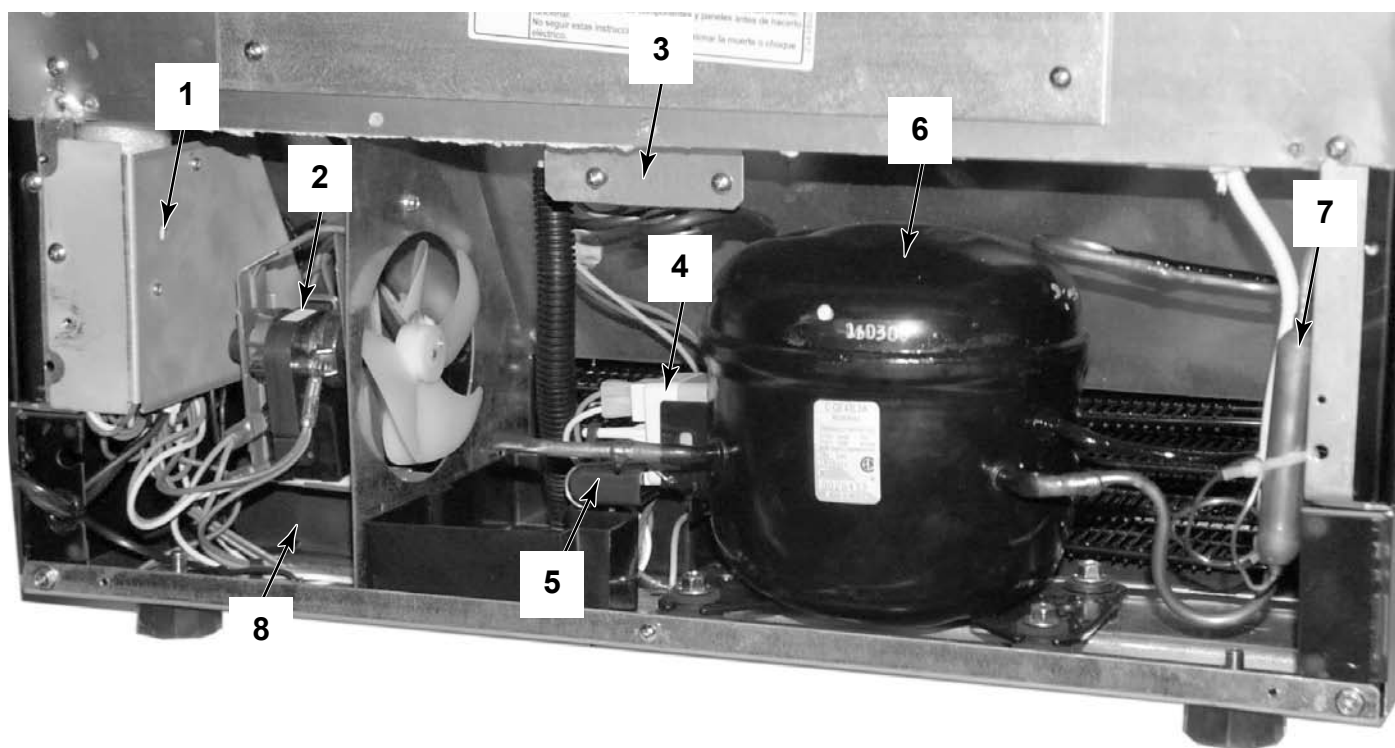
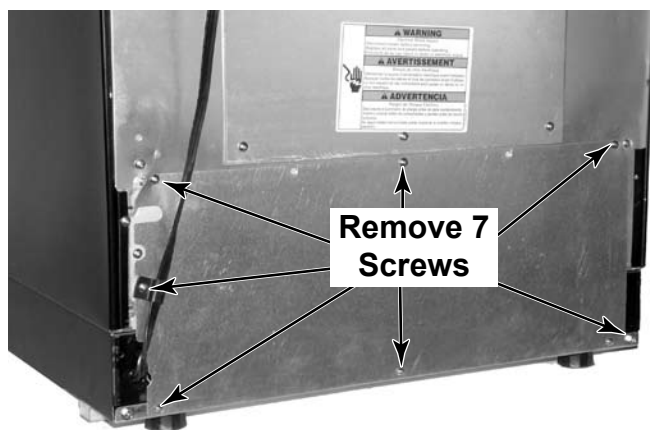

REMOVE DEFROST TIMER

⚠ WARNING



Electrical Shock Hazard
Disconnect power before servicing.
Replace all parts and panels before operating.
Failure to do so can result in death or electrical shock.

1. Remove the unit compartment cover (see page 4-15)
2. Remove the screw that secures the defrost timer mounting plate in the unit compartment.

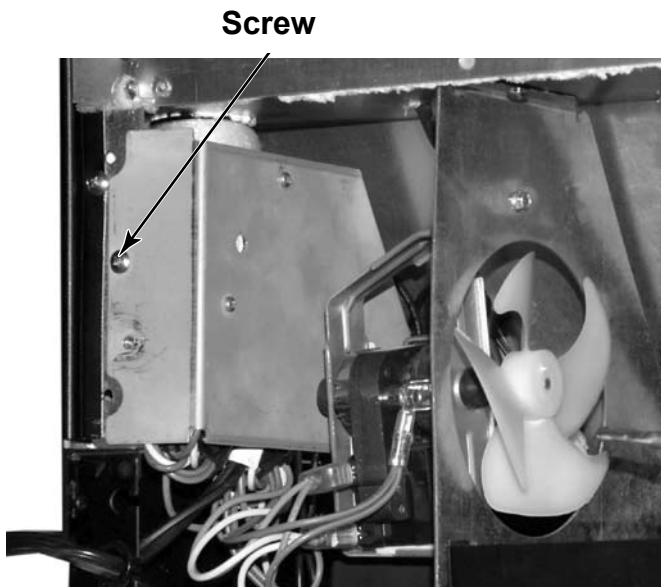

3. Remove the two screws that secure the defrost timer to the mounting plate.

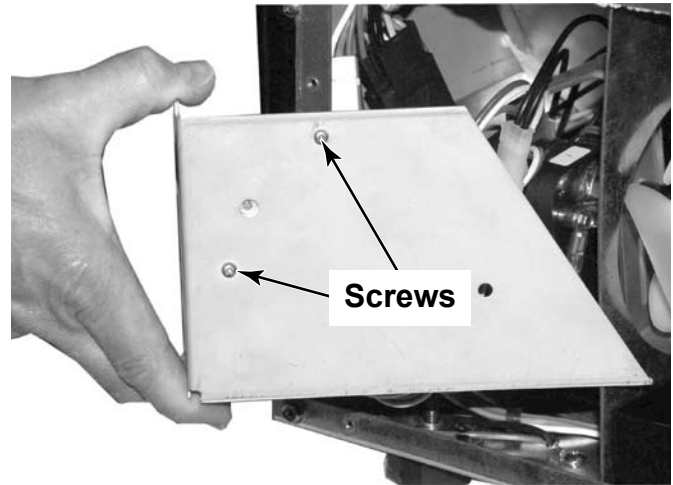

4. Disconnect the 4 wire connector from the defrost timer.

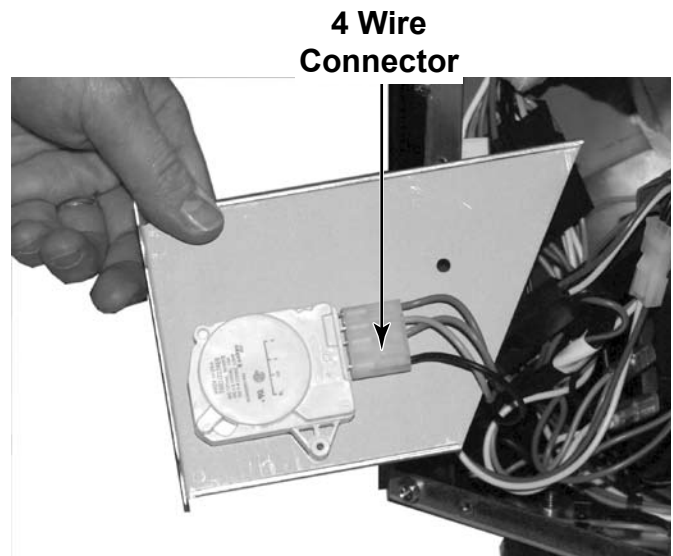

UNIT COMPARTMENT WIRE CONNECTORS

⚠ WARNING



Electrical Shock Hazard
Disconnect power before servicing.
Replace all parts and panels before operating.
Failure to do so can result in death or
electrical shock.

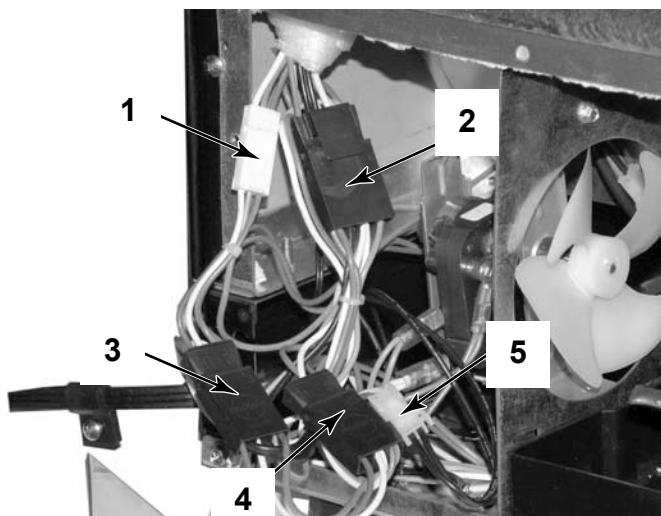

1. White Connector - 3 wire
2. Black Connector - 4 wire
3. Black Connector - 3 wire
4. Black Connector - 3 wire
5. White Connector - 2 wire

REMOVE THE RELAY / OVERLOAD & RUN CAPACITORS

⚠ WARNING



Electrical Shock Hazard
Disconnect power before servicing.
Replace all parts and panels before operating.
Failure to do so can result in death or
electrical shock.

1. Remove the unit compartment cover (see page 4-15)
2. Use a small screwdriver to lift the wire retain-er off of the Run Capacitor



3. Disconnect the wire connector from the Re-lay / Overload.

4. Pull the Run capacitor and the Relay / Over-load off the terminals of the compressor.



5. Pull the Run capacitor off the support rod of the Relay / Overload.

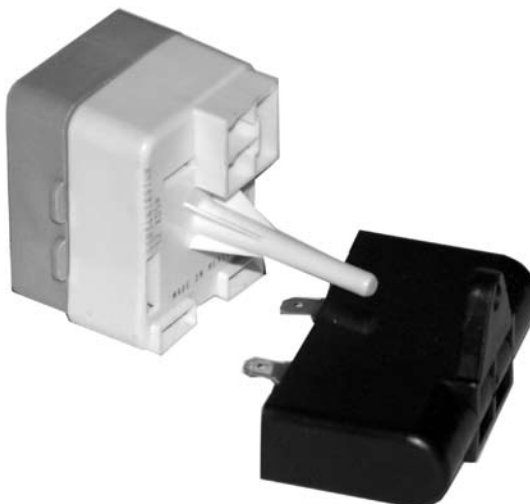

REMOVE DRAIN PAN

⚠ WARNING



Electrical Shock Hazard
Disconnect power before servicing.
Replace all parts and panels before operating.
Failure to do so can result in death or electrical shock.

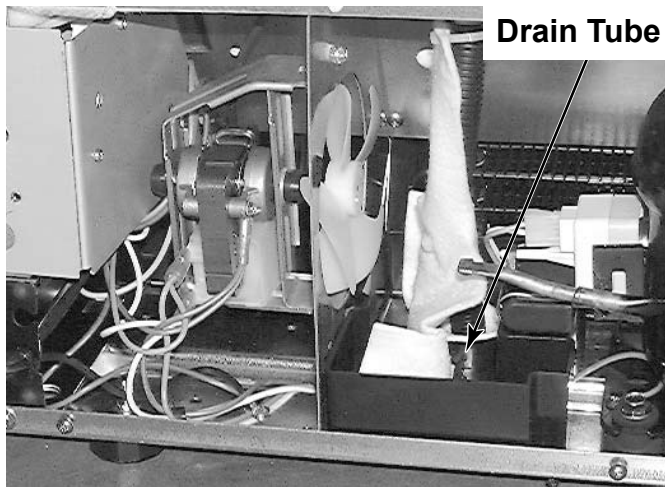

1. Remove the unit compartment cover (see page 4-15)

2. Pull the drain tube out of the drain pan.

3. Use a small flat blade screwdriver to pry up the corner of the drain pan to release the retainer pin. Be sure to save the retainer pin for reinstallation.

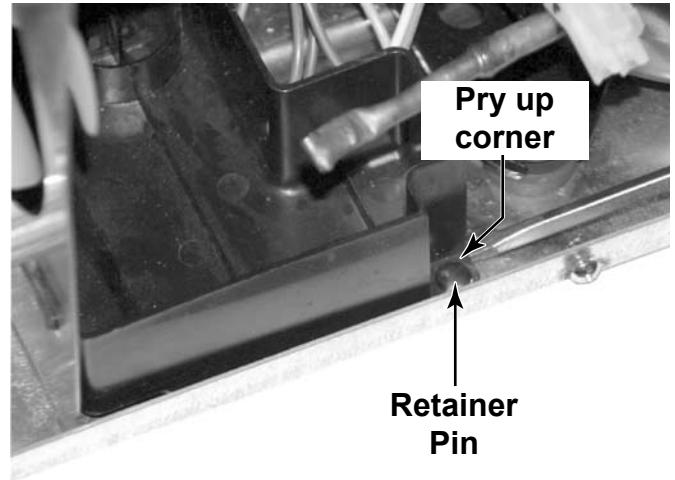

4. Lift the drain pan and pull the two tabs out of the slots in the condenser fan bracket and remove the drain pan from the unit.

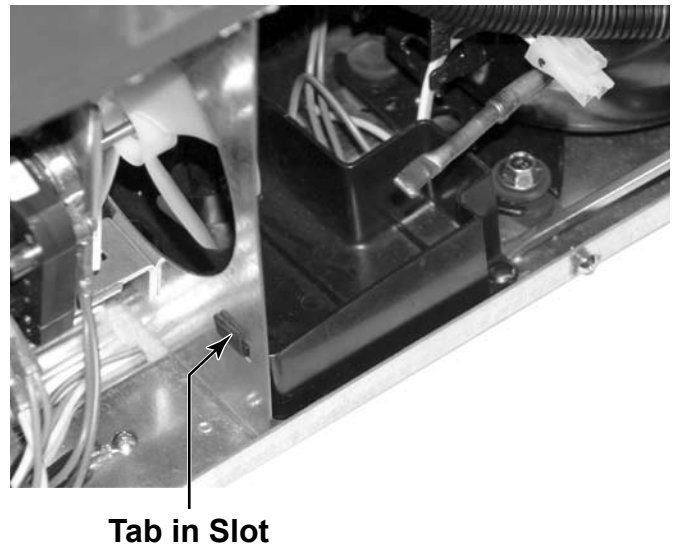

REMOVE CONDENSER FAN

⚠ WARNING



Electrical Shock Hazard
Disconnect power before servicing.
Replace all parts and panels before operating.
Failure to do so can result in death or electrical shock.

1. Remove the unit compartment cover (see page 4-15)
2. Remove the drain pan (see page 4-19)
3. Remove three wire connectors from the condenser fan.

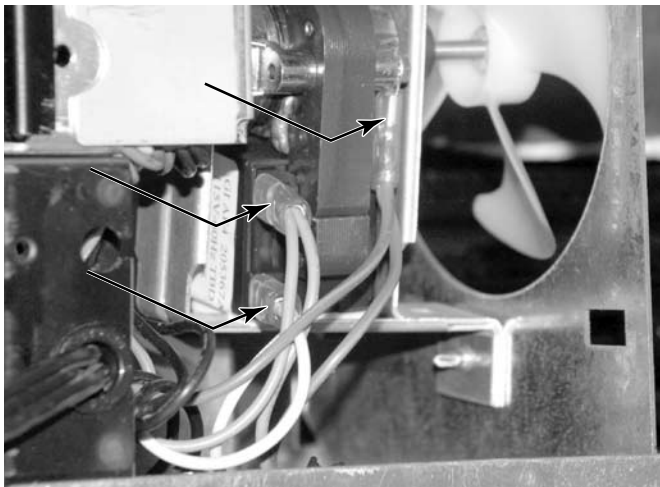

4. Remove two screws that secure the condenser fan to the bracket and remove the fan.

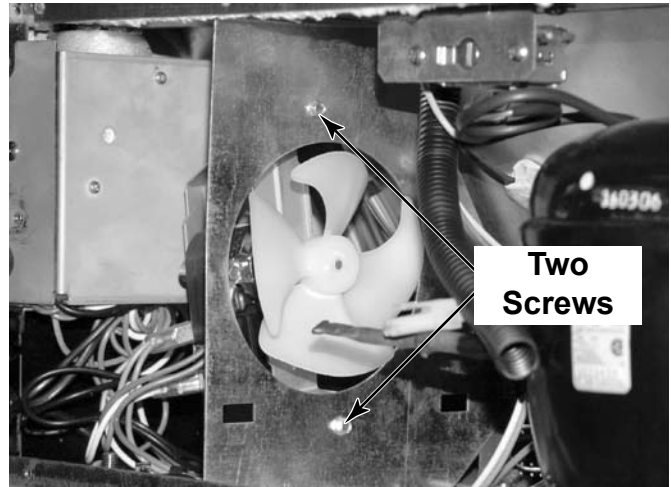

REMOVE TEMPERATURE DISPLAY TRANSFORMER

⚠ WARNING



Electrical Shock Hazard
Disconnect power before servicing.
Replace all parts and panels before operating.
Failure to do so can result in death or electrical shock.

1. Remove the unit compartment cover (see page 4-15)
2. Remove the drain pan (see page 4-19)
3. Remove the condenser fan (see page 4-20)
4. Remove the two screws that secure the temperature display transformer to the unit.

Remove Two Screws

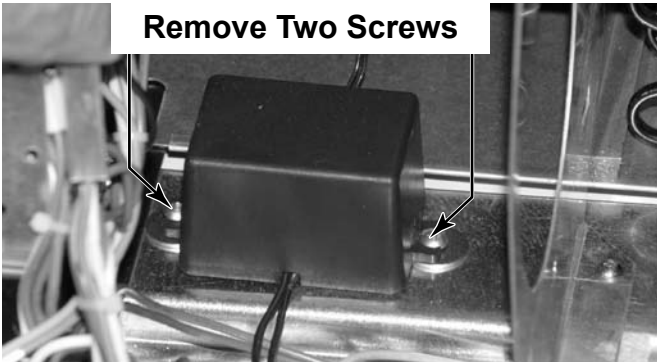

5. Disconnect the two wire connectors from the temperature display transformer to remove it.

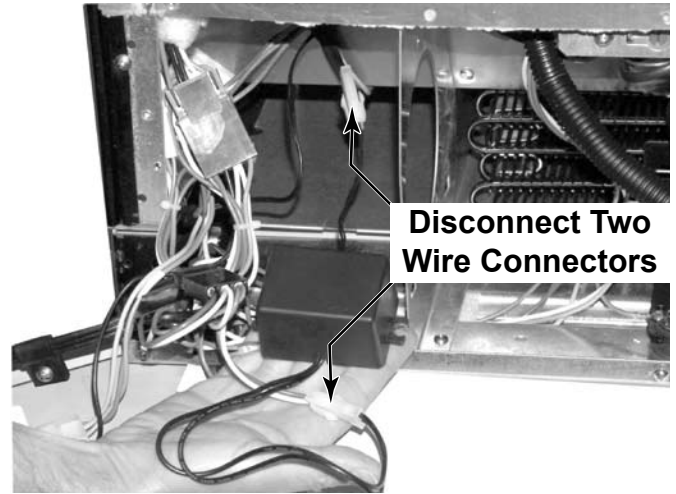

REMOVE COMPRESSOR

⚠ WARNING



Electrical Shock Hazard
Disconnect power before servicing.
Replace all parts and panels before operating.
Failure to do so can result in death or
electrical shock.

1. Remove the unit compartment cover (see page 4-15)
2. Remove the Run capacitor and the Relay / Overload (See page 4-18)



**Remove the Run Capacitor
and Relay / Overload**

3. Access the sealed system and discharge the refrigerant into an approved recovery system.

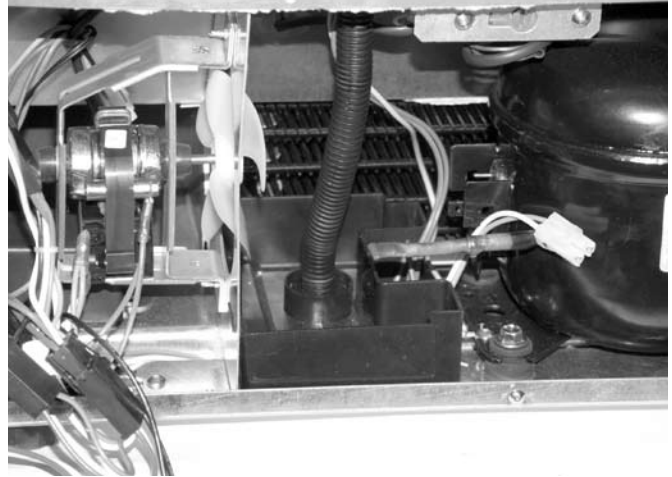

4. Unbrazed the suction and discharge lines from the compressor.
5. Cut the filter / drier (do not use a torch) from the system.
6. Remove the three bolts that secure the compressor to the unit.
7. Lift the compressor out of the unit.

REMOVE AMBIENT THERMOSTAT (UW, BC)

⚠ WARNING



Electrical Shock Hazard
Disconnect power before servicing.
Replace all parts and panels before operating.
Failure to do so can result in death or electrical shock.

1. Remove the unit compartment cover (see page 4-15)
2. Remove the two screws that secure the thermostat to the unit in the unit compartment.

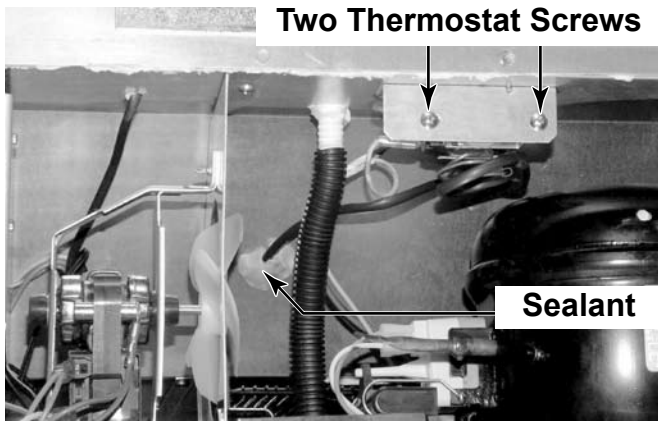

3. Use a small flat blade screwdriver to open the two screw covers and remove the two screws that secure the lower thermostat bulb to the lower back wall of the inside of the unit.



4. Push the thermostat bulb back through the hole in the unit.

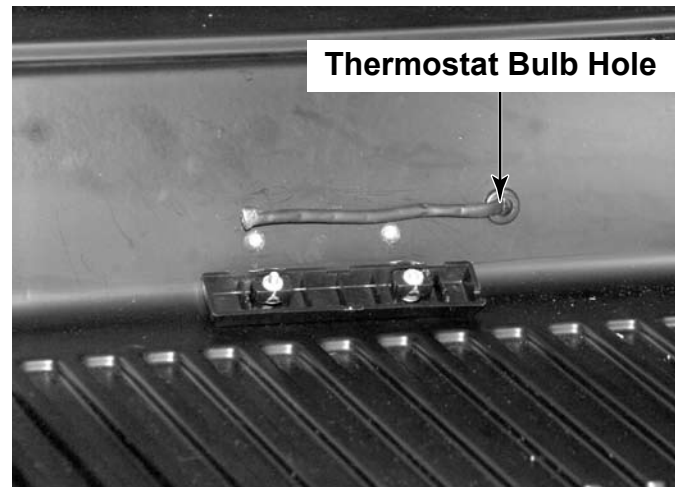

5. When reassembling the unit, be sure to replace the sealant that surrounds the thermostat bulb in the unit compartment.

6. Disconnect the three wire connectors from the thermostat.

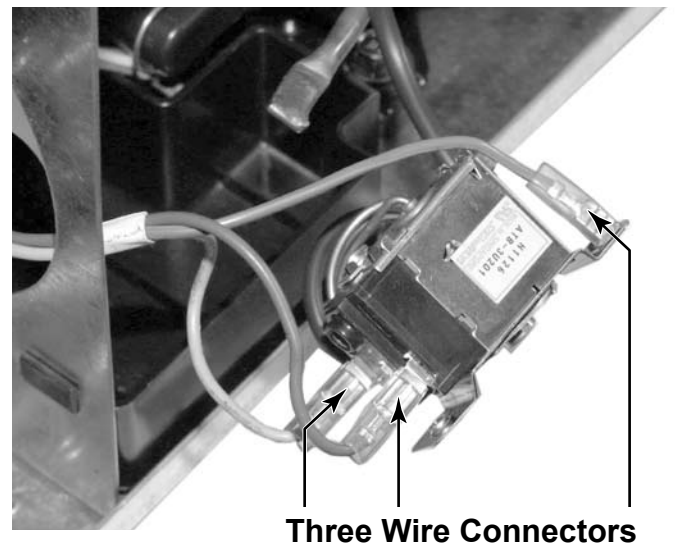

REMOVE INTERIOR LIGHT BULB

⚠ WARNING



Electrical Shock Hazard
Disconnect power before servicing.
Replace all parts and panels before operating.
Failure to do so can result in death or electrical shock.

1. Open the unit door.
2. Remove the one screw that secures the light cover to the top of the unit and remove the cover.

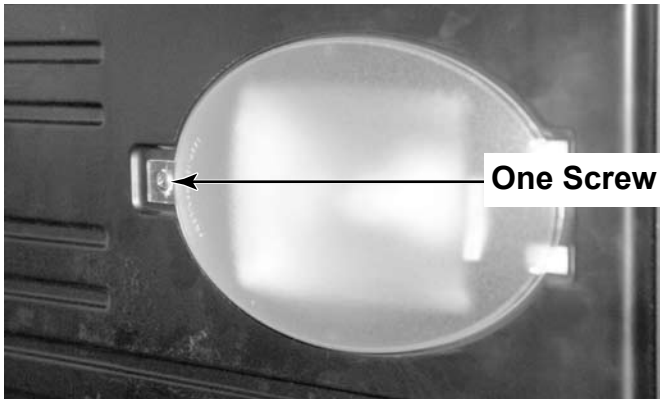

3. Unscrew the bulb to remove it.

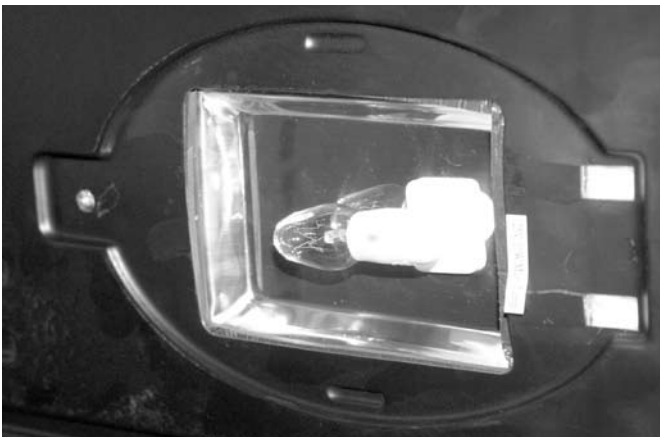

REMOVE DOOR SWITCH ACTUATOR (UW, BC)

1. Open the unit door.
2. Remove the two screws that secure the actuator to the bottom of the door.

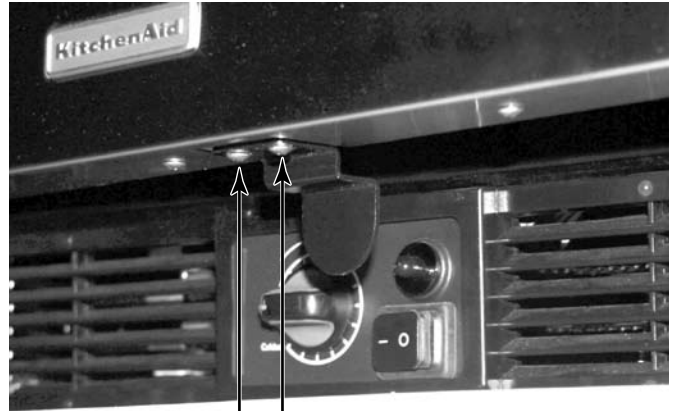

Two Screws

REMOVE THE DOOR

1. Remove the three screws that secure the top door hinge to the unit.

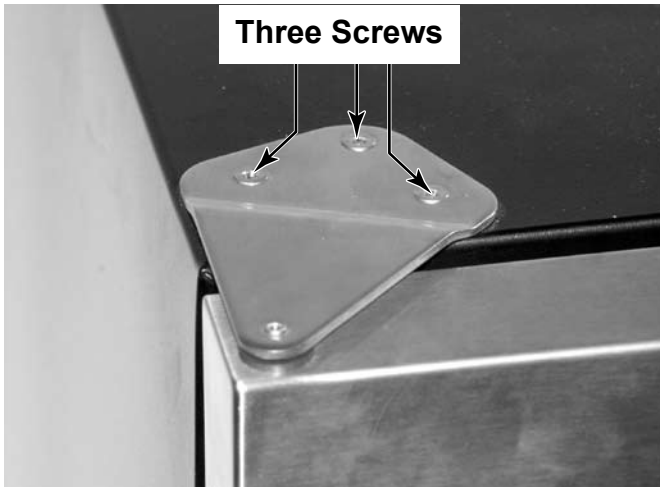

2. Lift the door up off the lower hinge pin and place the door on a soft protected surface.

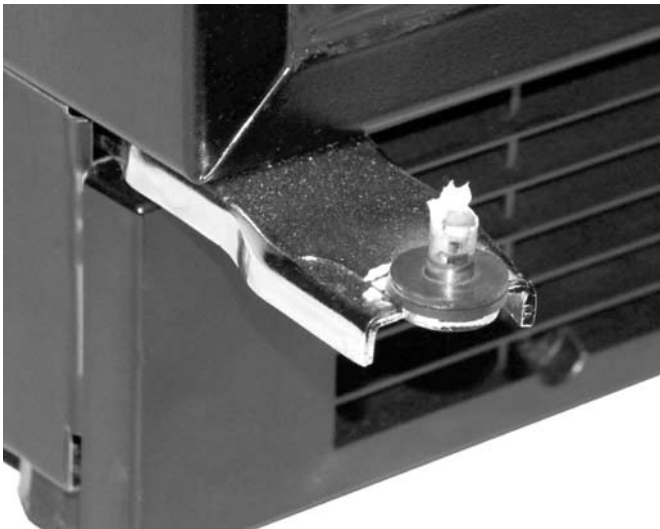

REMOVE THE DOOR SKIN AND HANDLE

1. Remove the door (See page 4-25)
2. Remove the four screws at the bottom of the door.

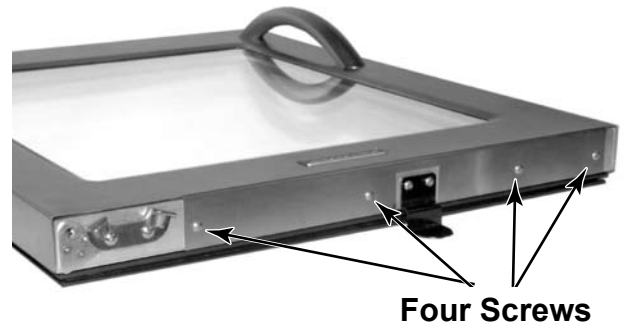

3. Lift the door skin off of the inner door.



4. Turn the door skin over and lay it on a protected surface.

5. Remove the two screws that secure the door handle to the door skin.

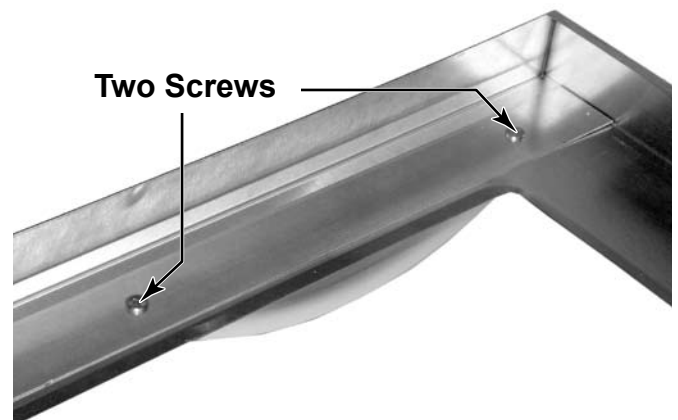

REMOVE DOOR GASKET

1. Open the door of the unit.
2. Starting at one of the corners, carefully pull the gasket away from the door. Allow the rubber tab to slide out of the channel in the door.

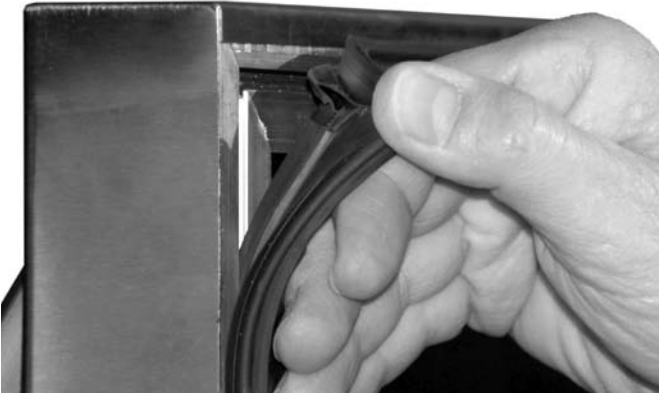

3. Replace the gasket by starting at one of the corners and pressing the rubber tab of the new gasket into the channel in the door. Work your way around the door in one continuous direction until finished.

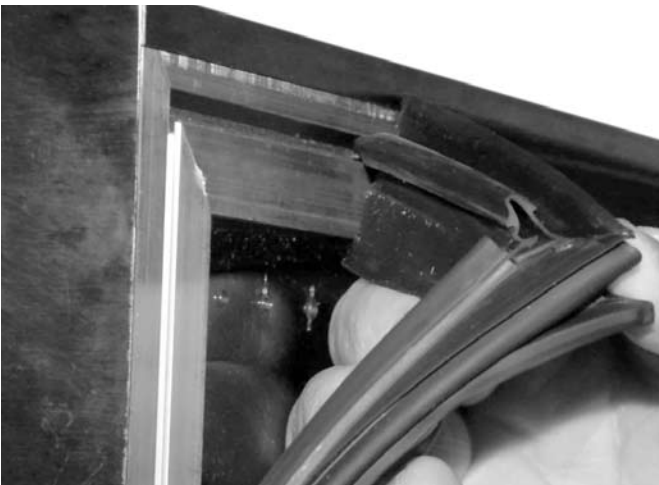

BEVERAGE CENTER LAYOUT (BC)

The Beverage Center has 3 separate temperature zones for cooling.

- The top section with one half glass shelf and one full glass shelf
- The mid section, one rack above the separator and below the full glass shelf.
- The lower section with two racks below the separator.

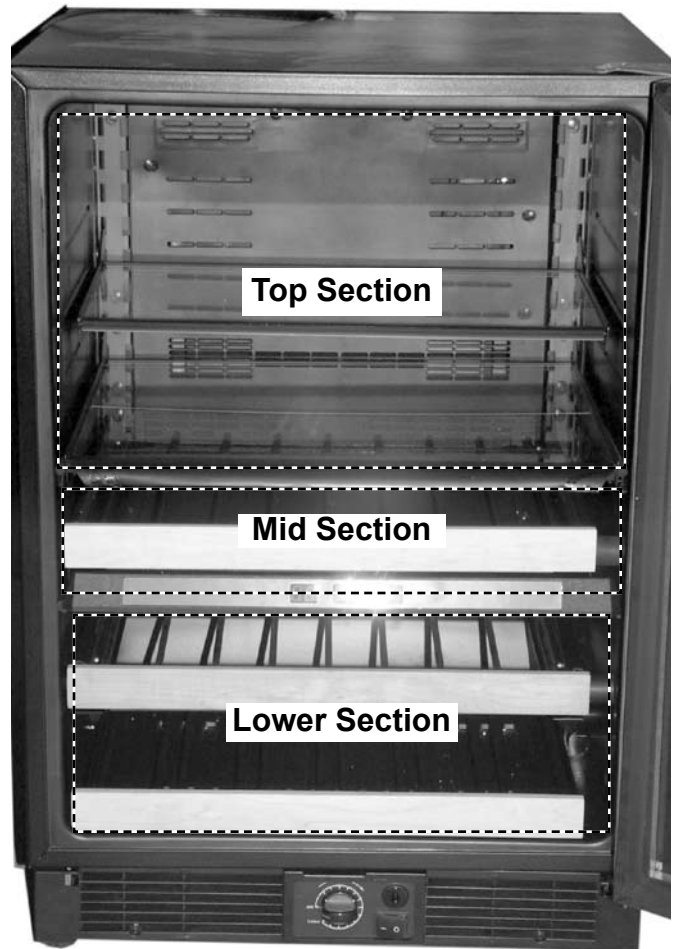

- To remove the glass shelves, lift and pull the shelf out as one piece.

UPPER COMPARTMENT TEMPERATURE DISPLAY THERMISTOR INSIDE EVAPORATOR COVER (BC)

1. Remove the evaporator cover (See page 4-4)

2. Release the two clips on each side and three clips on the top and bottom.

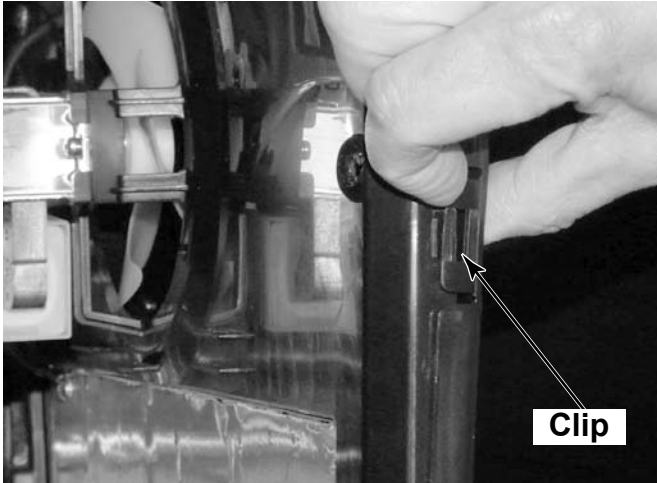

3. Open the two halves of the evaporator cover.

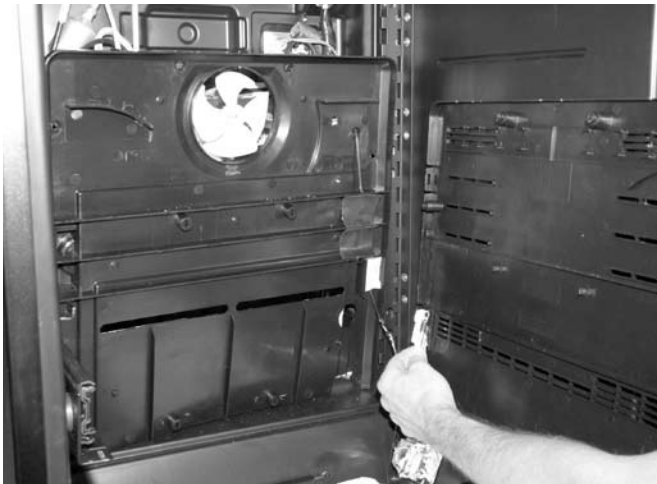

4. The upper compartment thermistor is hanging on a stud inside the evaporator halves

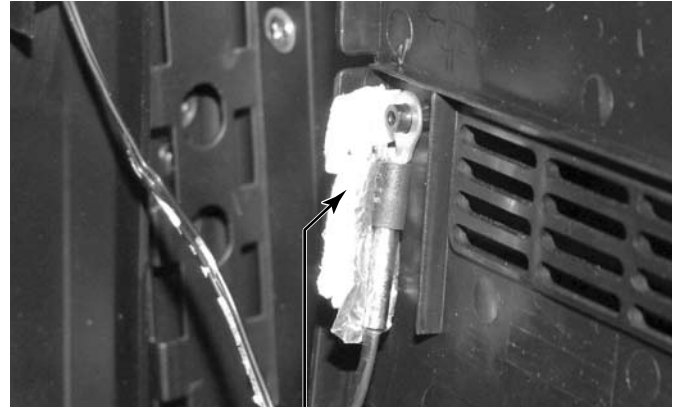

**Upper Compartment
Thermistor**

DISASSEMBLE SEPARATOR (UW, BC)

⚠ WARNING



Electrical Shock Hazard
Disconnect power before servicing.
Replace all parts and panels before operating.
Failure to do so can result in death or electrical shock.

1. Remove the separator from the unit (See page 4-3)
2. Remove the 12 screws that hold the separator halves together.

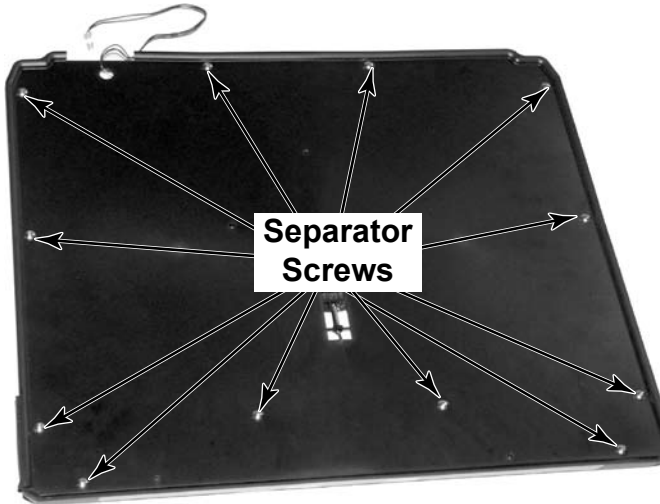

3. Open the two halves to access the lower zone temperature display thermistor.



4. (UW): Lift the foam insert to access the upper zone temperature display thermistor.
(BC): This will be the thermistor for the mid zone on the Beverage Center.



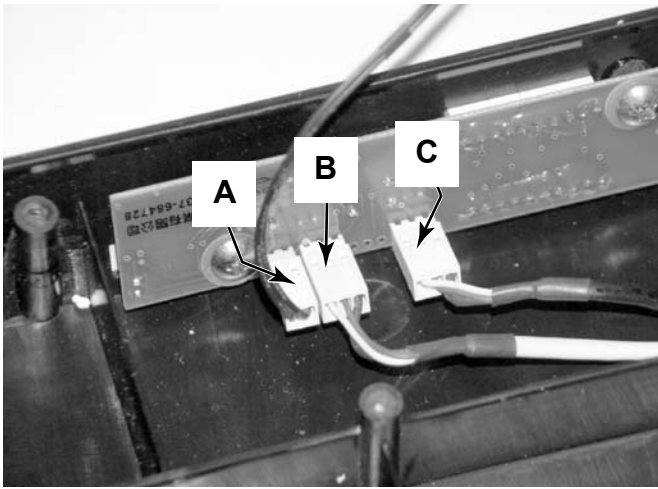

5. Pay close attention to the positioning of each thermistor and re-tape them in the same positions during reassembly.

6. (BC) The Beverage Center connector plugs:

- A. 2 pin feed wire from the back wall of unit.
- B. 3 pin connector for the top thermistor. (This will not be present on the Wine Cellar.)
- C. 3 pin connector for the bottom thermistor.

— NOTES —

COMPONENT TESTING

Before testing any of the components, perform the following checks:

- The most common cause for control failure is corrosion on connectors. Therefore, disconnecting and reconnecting wires will be necessary throughout test procedures.
- All tests/checks should be made with a VOM or DVM having a sensitivity of 20,000 ohms-per-volt DC, or greater.
- Check all connections before replacing components, looking for broken or loose wires, failed terminals, or wires not pressed into connectors far enough.
- Resistance checks must be made with power cord unplugged from outlet, and with wiring harness or connectors disconnected.



⚠ WARNING

Electrical Shock Hazard

- Disconnect power before servicing.**
- Replace all parts and panels before operating.**
- Failure to do so can result in death or electrical shock.**

EVAPORATOR FAN MOTOR

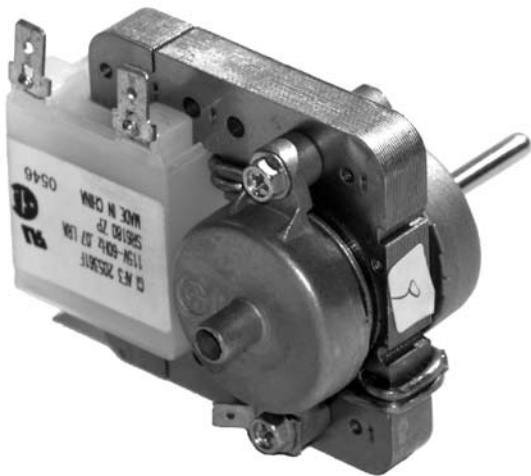

1. See Page 4-5 for access and removal procedures for the evaporator fan and motor.
2. Touch the leads of an ohmmeter to the terminals of the evaporator fan motor.
3. The meter should indicate 150 ohms \pm 10%

DEFROST HEATER



1. See Page 4-10 for access and removal procedures for the Defrost heater.
2. Touch the leads of an ohmmeter to the terminals of the Defrost Heater. The meter should indicate 150 ohms \pm 10%



⚠️ WARNING

Electrical Shock Hazard

Disconnect power before servicing.

Replace all parts and panels before operating.

Failure to do so can result in death or electrical shock.

LIGHT SWITCHES



**Door
Switch**



**Rocker Light
Switch**

1. See Page 4-14 for access and removal procedures for the light switches.
2. Touch the leads of an ohmmeter to the terminals of the normally closed door switch.
3. The meter should indicate continuity (closed circuit).
4. Push the door switch in and the meter should indicate no continuity (open circuit).
5. Touch the leads of an ohmmeter to the terminals of the manual rocker light switch.
6. When the switch is pressed on the “O” side the meter should indicate no continuity (open circuit).
7. When the switch is pressed on the “I” side the meter should indicate continuity (closed circuit).

RELAY / OVERLOAD

1. See Page 4-18 for access and removal procedures for the Relay / Overload.
2. Touch one lead of an ohmmeter to the top terminal on the front and the other lead to the top terminal on the back of the overload.
3. The meter should indicate continuity (closed circuit).



**Top terminal on
the front.**

**Top terminal on
the back.**





⚠ WARNING

Electrical Shock Hazard

Disconnect power before servicing.

Replace all parts and panels before operating.

Failure to do so can result in death or electrical shock.

CONDENSER FAN MOTOR



1. See Page 4-20 for access and removal procedures for the condenser fan and motor.
2. Touch the leads of an ohmmeter to the terminals of the condenser fan motor.
3. The meter should indicate 90 ohms \pm 10%

TEMPERATURE DISPLAY TRANSFORMER



Primary Winding Connector

Secondary Winding Connector

1. See Page 4-21 for access and removal procedures for the temperature display transformer.
2. The long wire shown on the left connects to the primary winding.
3. Touch the leads of an ohmmeter to the terminals of the long wire shown on the left.
4. The meter should indicate 225 ohms.
5. The short wire shown on the right connects to the secondary winding.
6. Touch the leads of an ohmmeter to the terminals of the short wire shown on the right.
7. The meter should indicate 4.5 to 4.6 ohms.



⚠️ WARNING

Electrical Shock Hazard

Disconnect power before servicing.

Replace all parts and panels before operating.

Failure to do so can result in death or electrical shock.

DEFROST TIMER

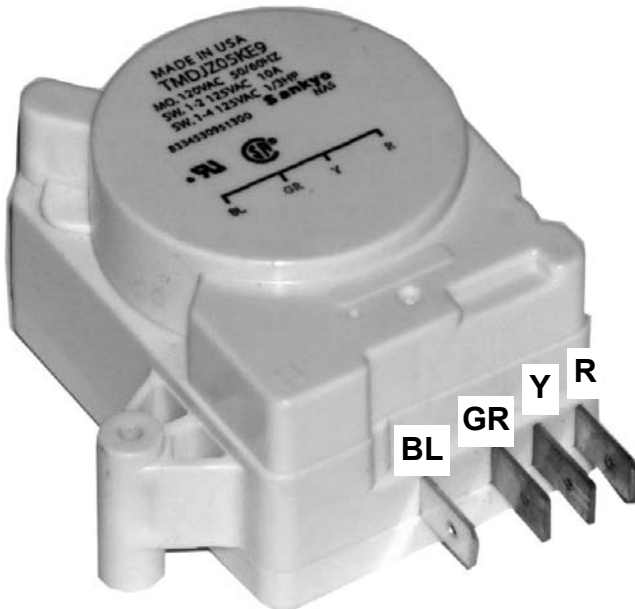

1. See Page 4-16 for access and removal procedures for the defrost timer.
2. Manually advance the timer by inserting a small flat head screwdriver into the access hole on the defrost timer. Turn it until you hear one “click” closely followed by another. Continue turning 360 degrees until one “click” is heard. This places the timer in the defrost mode.
3. An ohmmeter should indicate continuity between terminals “Y” to “R”. “Y” to “GR” should indicate no continuity.
4. Manually advance the timer until it “clicks” out of the defrost mode.
5. Measure for continuity again. “Y” to “R” should have no continuity, “Y” to “GR” should have continuity. If these readings are not correct, replace the defrost timer.

COMPRESSOR

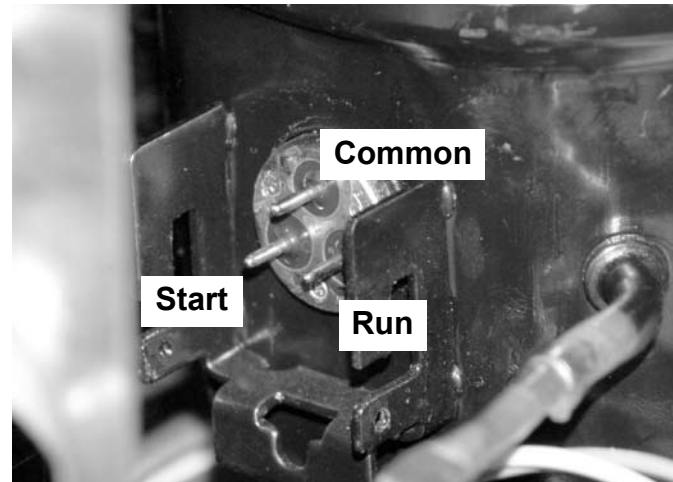

1. See Page 4-22 for access and removal procedures for the compressor.
2. Touch the leads of an ohmmeter to the Common and Run terminals of the compressor. The meter should indicate 15 ohms.
3. Touch the leads of an ohmmeter to the Common and Start terminals of the compressor. The meter should indicate 15 ohms.
4. Touch the leads of an ohmmeter to the Start and Run terminals of the compressor. The meter should indicate 30 ohms.
5. With meter set to the highest ohms scale, touch one lead to an exposed copper tubing and the other lead to each compressor terminal in turn. The meter should indicate zero ohms (open circuit)



⚠ WARNING

Electrical Shock Hazard

- Disconnect power before servicing.**
- Replace all parts and panels before operating.**
- Failure to do so can result in death or electrical shock.**

AMBIENT THERMOSTAT (UW, BC)



1. See Page 4-23 for access and removal procedures for the ambient thermostat.
2. Touch the leads of an ohmmeter to the two terminals of the ambient thermostat.
3. The meter should indicate continuity when the temperature is above _____ degrees F.

DEFROST BIMETAL



1. See page 4-11 for access and removal procedures for the defrost bimetal.
2. Touch the leads of an ohmmeter to the two terminals of the defrost bimetal.
3. The bimetal opens at 4 degrees C, 40 degrees F. and closes as -4 degrees C, 25 degrees F.

— NOTES —

DIAGNOSIS & TROUBLESHOOTING

Try the solutions suggested here first in order to avoid the cost of an unnecessary service call.

THE UW, BC, UR WILL NOT OPERATE

⚠ WARNING



Electrical Shock Hazard

Plug into a grounded 3 prong outlet.

Do not remove ground prong.

Do not use an adapter.

Do not use an extension cord.

Failure to follow these instructions can result in death, fire, or electrical shock.

- Is the power supply cord unplugged? Plug into a grounded 3 prong outlet.
- Has a household fuse blown, or has a circuit breaker tripped? Replace the fuse or reset the circuit.
- Is the Unit Control turned to the OFF position?

THE LIGHTS DO NOT WORK

- Is a light bulb loose in the socket? Unplug unit or disconnect power. Gently remove the bulb and reinsert. Plug in unit or reconnect power.
- Has a light bulb burned out? Replace with an appliance bulb of the same wattage, size, and shape.

THERE IS WATER IN THE DEFROST DRAIN PAN

- Is the unit defrosting? The water will evaporate. It is normal for water to drip into the defrost pan.
- Is it more humid than normal? Expect that the water in the defrost pan will take longer to evaporate. This is normal when it is hot or humid.

THE MOTOR SEEMS TO RUN TOO MUCH

- Is the temperature outside hotter than normal? Expect the motor to run longer under warm conditions. At normal temperatures, expect the motor to run about 40% to 80% of the time. Under warmer conditions, expect it to run even more of the time.
- Is the door opened often? Expect the motor to run longer when this occurs. In order to conserve energy, try to get everything you need out of the unit at once, keep wine bottles positioned label side up so that they are easy to find, and close the door as soon as the wine is removed.
- Is the control set correctly for the surrounding conditions?
- Is the door closed completely? Push the door firmly shut. If it will not shut all the way, see "The door will not close completely" later in this section.
- Are the condenser coils dirty? This prevents air transfer and makes the motor work harder. Clean the condenser coils.

TEMPERATURE IS TOO WARM

- Is the door opened often? Be aware that the unit will warm when this occurs. In order to keep the unit cool, try to get everything you need out of the unit at once, keep wine bottles positioned label side up so that they are easy to find, and close the door as soon as the wine is removed.
- Is the control set correctly for the surrounding conditions?
- Is the base grille blocked? For best performance, do not install the unit behind a cabinet door or block the base grille.

THERE IS INTERIOR MOISTURE BUILDUP

- Is the door opened often? To avoid humidity buildup, try to get everything you need out of the unit at once, keep wine bottles positioned label side up so that they are easy to find, and close the door as soon as the wine is removed. When the door is opened, humidity from the room air enters the unit. The more often the door is opened, the faster humidity builds up, especially when the room itself is very humid.
- Is it humid? It is normal for moisture to build up inside the unit when the air is humid.
- Is the control set correctly for the surrounding conditions?

THE DOOR IS DIFFICULT TO OPEN

! WARNING

Explosion Hazard
Keep flammable materials and vapors, such as gasoline, away from beverage center.
Failure to do so can result in death, explosion, or fire.

- Is the gasket dirty or sticky? Clean the gasket and the surface that it touches with warm water and mild detergent. Rub a thin coat of paraffin wax on the gasket following cleaning.

THE DOOR WILL NOT CLOSE COMPLETELY

- Are the racks or shelves out of position? Put the racks or shelves back into their correct positions.
- Is the gasket sticking? Clean the gasket and the surface that it touches. Rub a thin coat of paraffin wax on the gasket following cleaning.

WIRING DIAGRAMS

WINE CELLAR WIRING DIAGRAM

CIRCUIT DIAGRAM

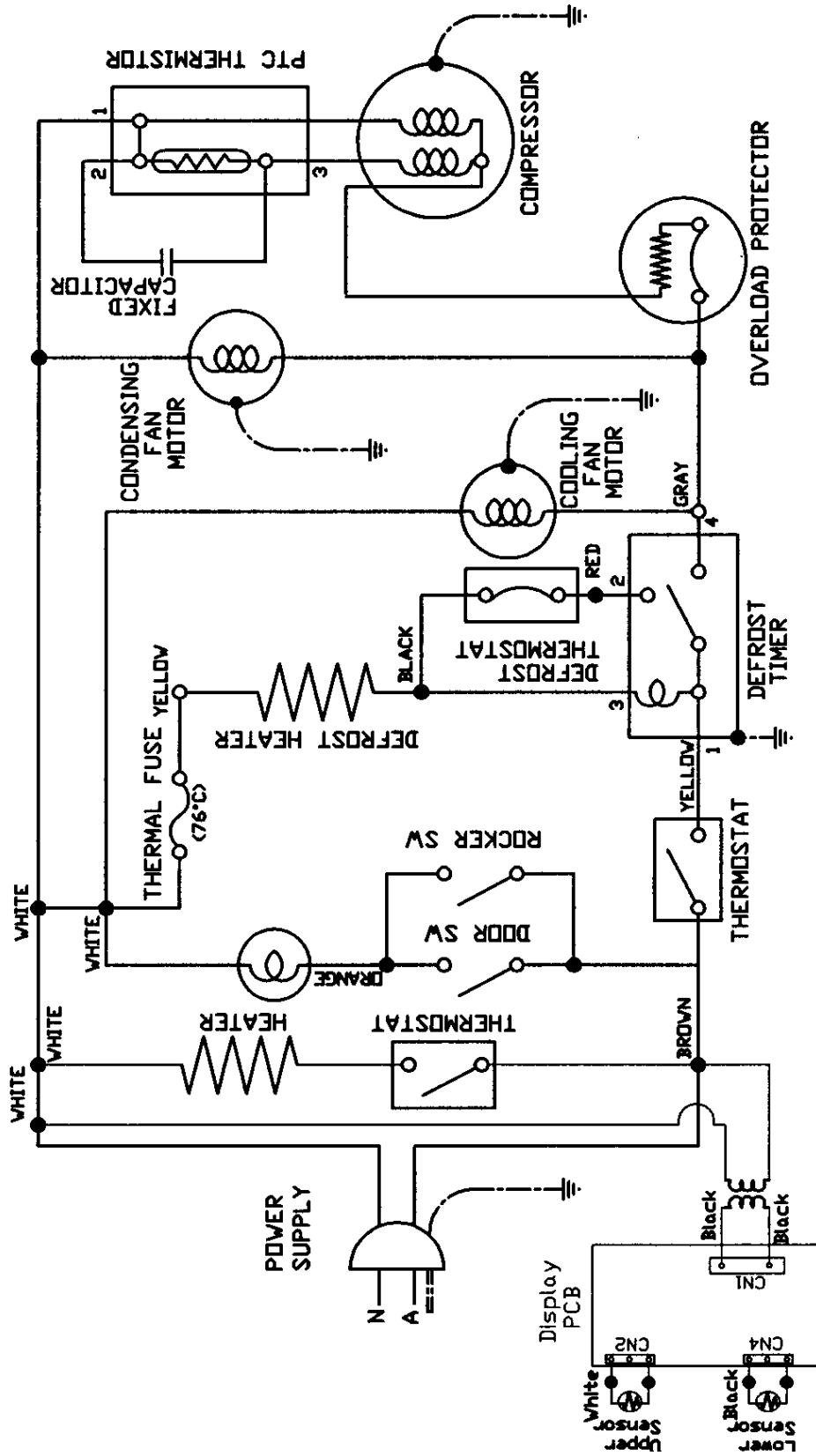

BEVERAGE CENTER WIRING DIAGRAM

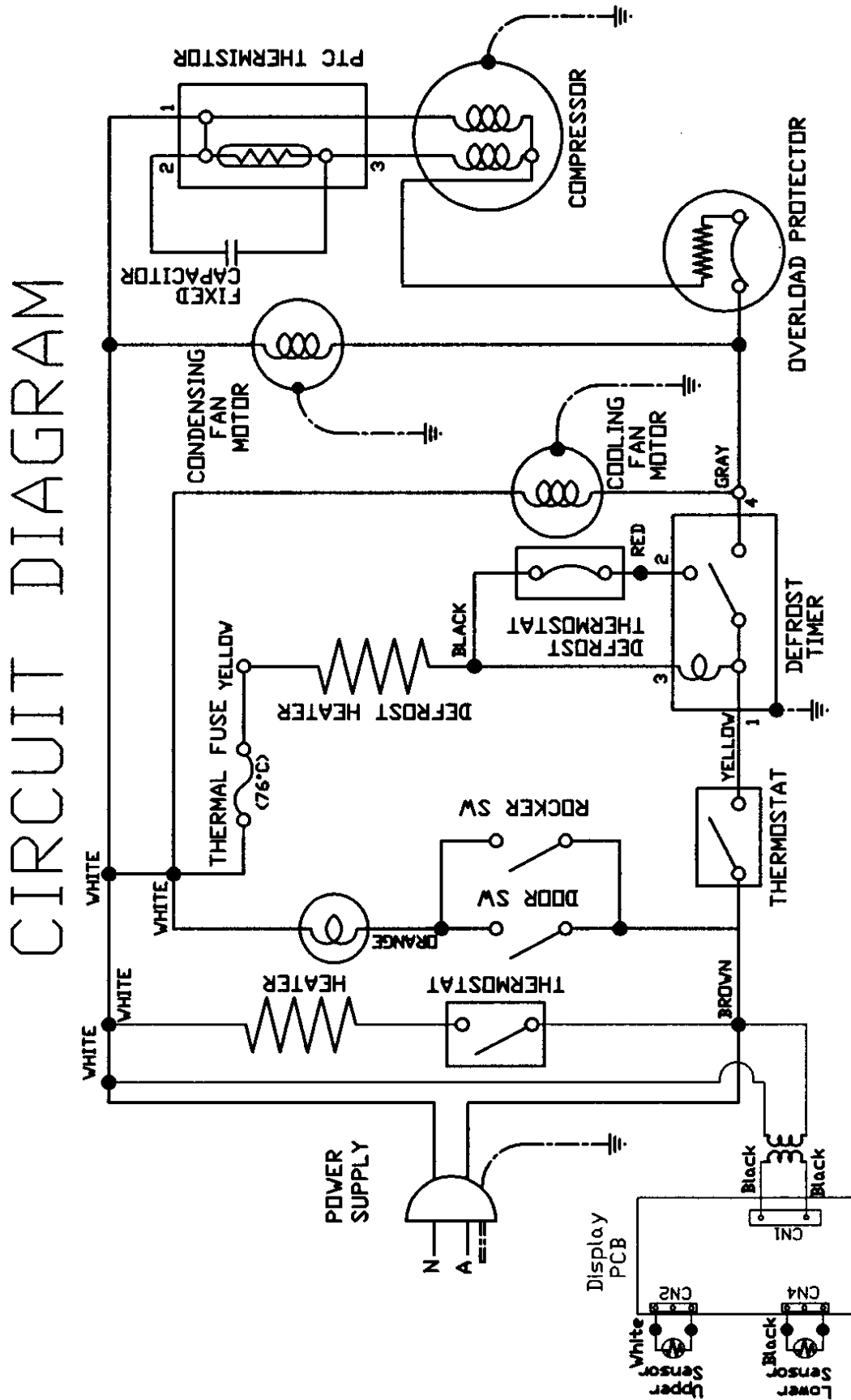

UNDERCOUNTER REFRIGERATOR WIRING DIAGRAM

CIRCUIT DIAGRAM

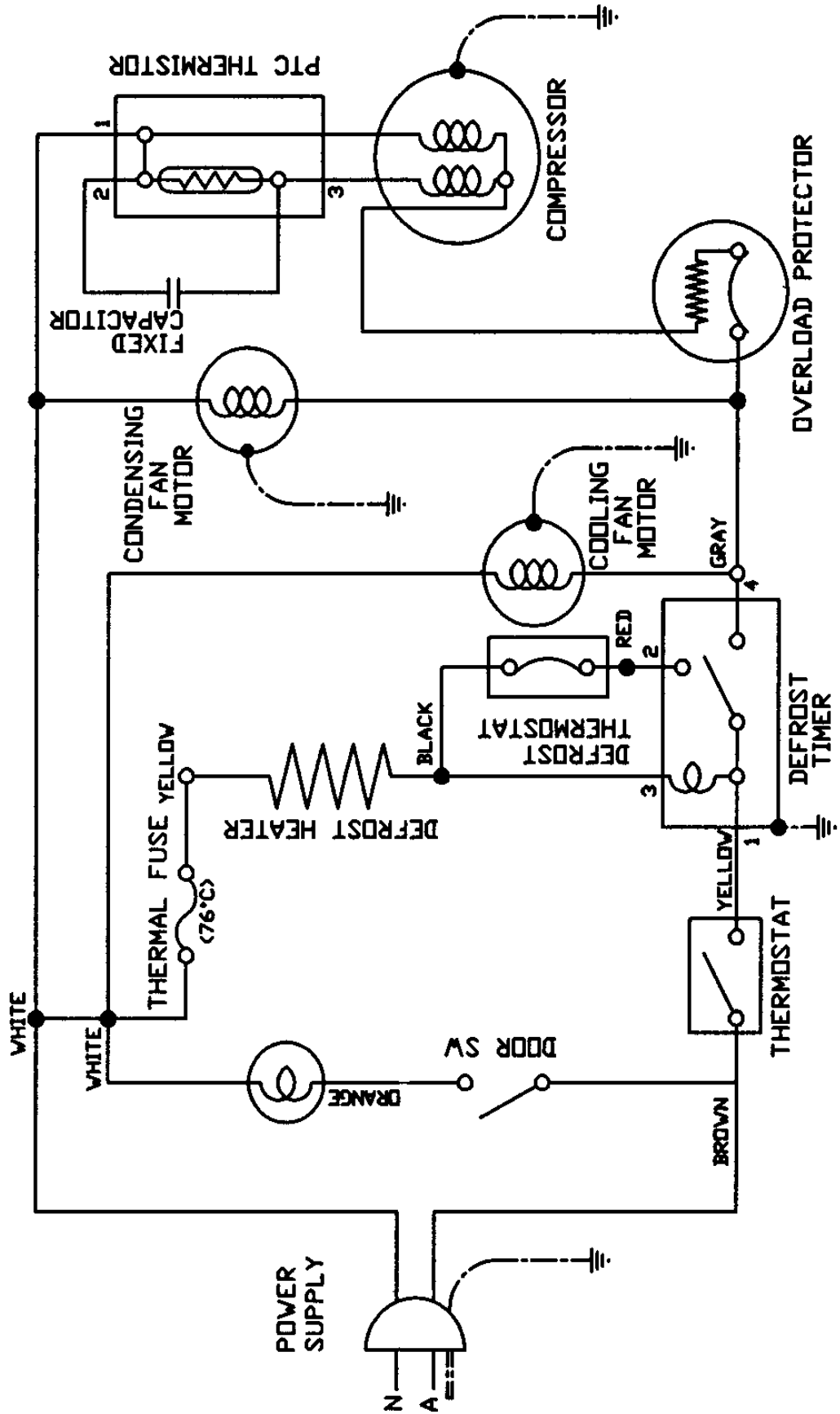

— NOTES —

**PRODUCT SPECIFICATIONS
AND
WARRANTY INFORMATION SOURCES**

IN THE UNITED STATES:

FOR PRODUCT SPECIFICATIONS AND WARRANTY INFORMATION CALL:

**FOR WHIRLPOOL PRODUCTS: 1-800-253-1301
FOR KITCHENAID PRODUCTS: 1-800-422-1230
FOR ROPER PRODUCTS: 1-800-447-6737**

FOR TECHNICAL ASSISTANCE WHILE AT THE CUSTOMER'S HOME CALL:

THE TECHNICAL ASSISTANCE LINE: 1-800-253-2870

**HAVE YOUR STORE NUMBER READY TO IDENTIFY YOU AS AN
AUTHORIZED SERVICER**

FOR LITERATURE ORDERS:

PHONE: 1-800-851-4605

FOR TECHNICAL INFORMATION AND SERVICE POINTERS:

www.servicematters.com

IN CANADA:

FOR PRODUCT SPECIFICATIONS AND WARRANTY INFORMATION CALL:

1-800-461-5681

FOR TECHNICAL ASSISTANCE WHILE AT THE CUSTOMER'S HOME CALL:

THE TECHNICAL ASSISTANCE LINE: 1-800-488-4791

**HAVE YOUR STORE NUMBER READY TO IDENTIFY YOU AS AN
AUTHORIZED SERVICER**

KitchenAid®
FOR THE WAY IT'S MADE.®