

# SERVICE MANUAL

*for*

## **THERMADOR® BUILT-IN OVENS**



*Model CM302S*

**MODELS: CM301B / CM301W / CM301S  
CM302B / CM302W / CM302S**

***Thermador***®

# Table of Contents

General .....	1-8	<b>Microwave Components Description .....</b>	<b>61-67</b>
Data Plate Location .....	1	Interlock Switches .....	62
Symbols You Will See In The Manual .....	2	Latch Mounted switch .....	62
Avoid Exposure To Excessive Microwave Energy .....	3	Oven Mounted switches .....	63
Cautions To Observe When Troubleshooting .....	4	Switches Activated by Hook .....	64
Avoid Electrical Shock .....	5	20-Ampere Fuse, Fuse Failure .....	65
Measuring For Microwave Radiation Leakage .....	6-7	Diode, High Voltage Transformer, Magnetron Tube .....	66
Thermador Warranty .....	8	Microwave Board, Stirrer Motor, Microwave Transformer Cooling Fan & Air Switch .....	67
<b>Servicing Components .....</b>	<b>9</b>	<b>CM Lower Oven .....</b>	<b>68-108</b>
Component Locations .....	9	CM Relay Board Matrix .....	69
Removing Trim, & Top Plenum Covers .....	10	CM DAC Relay Board .....	70-73
Removing Electronic Oven Control Board .....	11	Wire Harnesses .....	74-75
Removing Fuseblock & Microwave PCB Control .....	12	Troubleshooting Chart for	
Removing Light Transformer & Double Line Break Relay .....	13	Relay Board Headers Pin Failures .....	76-77
Removing Stirrer Motor .....	14	CM Oven Control Panel .....	78
Removing Transformer Cooling Fan & Microwave Transformer Air Switch Assembly .....	15	Electronic Oven Controls .....	79
Removing Magnetron Fan Assembly .....	16	Control Panel Assembly .....	80
Removing Crossflow Top Cooling Blower .....	17	Glass Touch Panel .....	81
Removing High Voltage Microwave Capacitor .....	18	Display Head .....	82
Removing High Voltage Diode .....	19	Troubleshooting Chart for	
Removing High Voltage Microwave Transformer .....	20-21	Display Head Pin Failures .....	83
Removing Magnetron, & Magnetron Thermal Cutout ..	22-23	CM Lower Oven Illustration .....	84
Removing Control Panel Assembly, Display Board, & Touch Panel Glass .....	24	Removing Hidden Bake Element .....	85-86
Removing Upper (Or Single) Oven Door Switch .....	25	Removing Oven Temperature Sensor .....	87
Removing Door Latch Assembly, High-Temp Cutout, & Monitor & Secondary Switch Assembly .....	26-27	Removing Convection Bake Element .....	88
Removing A Halogen Light Assembly .....	28-29	Removing Convection Fan Motor .....	89-90
Removing Broil Element & Stirrer Blade Assembly .....	30-31	Removing Halogen Lamp Holder .....	91
Removing Waveguide .....	32-33	Removing Lamp Transformer & Lower Oven Double Line Break Relay .....	92
Removing Convection Element & Motor .....	34-36	Removing Oven Light Switch, Oven Door Latch Assembly and High Temp Cut-out .....	93-94
Removing Meat Probe Jack .....	37	Removing Air Switches .....	95-96
Removing Hidden Bake Element .....	38-39	Removing a Blower .....	97-98
Removing Oven Thermal Sensor .....	40	Removing Lower Oven Door .....	99
Removing Upper (Or Single) Oven Door Gasket .....	41	Removing Oven Door Gasket .....	100
Removing, Reinstalling Microwave Oven Door .....	42-44	Removing Oven Door Components .....	101
Removing Upper (Or Single) Oven Door Handle & Outer Glass Assembly .....	45	Removing Oven Module .....	102
Removing An Oven Door Hinge, Actuator Arm, Center Glass, RF Screen, & Inner Glass .....	46-48	Troubleshooting .....	103
Troubleshooting .....	49	Blower Motor, Air Switch .....	103
Testing Components, 20A Time-Delay Fuse .....	49	Convection Fan Motor, Lamp Transformer .....	104
Transformer Cooling Fan Motor .....	49	Oven Door Latch Assembly .....	105
Light Transformer, Double Line Break Relay .....	50	Hidden Bake Element, Broil Element .....	106
Stirrer Motor, High Voltage Diode .....	51	Convection Bake Element, Hi-Temp Cutout .....	107
High Voltage Capacitor, High Voltage Transformer .....	52	Fault Codes .....	108
Magnetron, Magnetron Thermal Cutout (TCO) .....	53	<b>Schematic &amp; Wiring Diagrams .....</b>	<b>109-113</b>
Magnetron Fan Motor, Crossflow Blower Motor .....	54	CM301 Schematic Diagram .....	109
Door Latch Assembly, Monitor & Secondary Switches .....	55	CM301 Wiring Diagram .....	110
Door Switch, Oven Thermal Sensor .....	56	CM302 Schematic Diagram .....	111
Broil Element, Bake Element .....	57	CM302 Wiring Diagram .....	112
Convection Element, Convection Motor .....	58	CM301 Electronic Oven Control Wiring .....	113
M/W Transformer Air Switch, Meat Probe Jack .....	59	CM302 Electronic Oven Control Wiring .....	113
Microwave PCB Control .....	60		

# “CM” Oven Service Manual

THE CM OVEN SERVICE MANUAL CONTAINS INFORMATION THAT IS NECESSARY FOR SERVICING THE THERMADOR® BUILT-IN OVEN MODELS:

CM301B / CM301W / CM301S

CM302B / CM302W / CM302S

**THIS MANUAL IS DESIGNED TO BE USED ONLY BY QUALIFIED SERVICE PERSONNEL. THERMADOR RECOMMENDS THAT CUSTOMERS DO NOT SERVICE THEIR OWN UNITS, DUE TO THE COMPLEXITY AND THE RISK OF HIGH-VOLTAGE ELECTRICAL SHOCK.**

THE INFORMATION IS ORGANIZED TO HELP THE SERVICER EASILY FIND WHAT IS NEEDED TO REPAIR THE UNIT.

## GENERAL

### DATA PLATE LOCATION



Data Plate (behind oven cooling vent, right side)

## SYMBOLS YOU WILL SEE IN THE MANUAL

The following symbols are provided throughout this manual. For reasons of personal safety

and proper operation and servicing of the oven, follow the instructions carefully each time you see one of the symbols.

### **WARNING**

This symbol alerts you to such dangers as personal injury, burns, fire, and electrical shock.

### **CAUTION**

This alerts you to actions that could cause product damage (scratches, dents, etc.), and damage to your personal property.

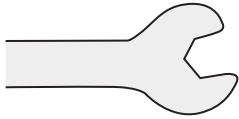

### **Tech Tip !!**

This symbol alerts you to a service tip or a special procedure.

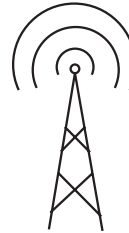

### **Service Alert !!**

This symbol alerts you to check for microwave radiation leakage and to record the reading on the service repair ticket while in the customers.

THERMADOR ASSUMES NO RESPONSIBILITY FOR ANY REPAIRS MADE ON OUR PRODUCTS BY ANYONE OTHER THAN AUTHORIZED THERMADOR SERVICE TECHNICIANS.

## TO AVOID EXPOSURE TO EXCESSIVE MICROWAVE ENERGY

Observe these precautions before and during servicing:

1. Do not operate or allow the oven to be operated with the door open.
2. Make the following safety checks on all ovens to be serviced before activating the magnetron or other microwave source, and make repairs as necessary:
  - a) Interlock Operation.
  - b) Proper Door Closing.
  - c) Seal and Sealing Surfaces (arcing, wear, and other damage).
  - d) Damage To or Loosening of Hinges and Latches.
  - e) Evidence of Dropping or Abuse.
3. Before turning on microwave power for any service test or inspection within the microwave generating compartments, check the magnetron, waveguide, or transmission line, and cavity for proper alignment, integrity, and connections.
4. Any defective or misadjusted components in the interlock, monitor, door seal, and microwave generating and transmission systems shall be repaired, replaced, or adjusted by procedures described in this manual before the oven is released to the owner.

### **WARNING**

This product should be serviced  
only by trained qualified personnel.

5. Although this product has been manufactured in compliance with “FDA Radiation Performance Standards, 21 CFR Subchapter J,” it is very important that all repairs should be made in accordance with procedures described in this manual to avoid being exposed to excessive microwave radiation.
6. Check for radiation leakage before and after every servicing. Refer to “Measuring For Microwave Radiation Leakage” on Page 6.
7. Certain components used in the microwave oven are important for safety. It is essential to replace these critical parts only with manufacturer’s specified parts to prevent microwave leakage, shock, fire, or other hazards. Do not modify the original design.

## CAUTIONS TO OBSERVE WHEN TROUBLESHOOTING

Unlike many other appliances, the microwave oven is high-voltage, high-current equipment. Although it is free from danger in ordinary use, extreme care should be taken during repair.

### CAUTION

Remove your wristwatch when working close to or when replacing the magnetron.

1. Check the grounding. The microwave oven is designed to be used when grounded. Make sure it is grounded properly before beginning repair work.
2. Discharge the electric charge in the high-voltage capacitor. For about 30-seconds after the oven stops, an electric charge remains in the high-voltage capacitor. When replacing or checking parts, short between the oven chassis and the terminal of the high-voltage capacitor (terminals of lead wire from magnetron filament, high-voltage transformer filament lead wire, and diode lead wire) with an insulated screwdriver to discharge.

### WARNING

There is high-voltage present, with high current capabilities, in the circuits of the high-voltage winding and filament winding of the high-voltage transformer. It is extremely dangerous to work on or near these circuits with the oven energized.

Do not measure the voltage in the high-voltage circuit, including the filament voltage of the magnetron.

Never touch any circuit wiring with your hand or with an insulated tool during operation.

3. When parts must be replaced, disconnect the power to the unit.
4. Avoid inserting nails, wire, etc. through any holes in the unit during operation. Never insert a wire, nail, or any other metal object through the lamp holes on the cavity or any other holes or gaps, because such objects may work as an antenna and cause microwave leakage.
5. Confirm after repair. After repairing or replacing parts, make sure that the screws of the oven, etc., are neither loose or missing. Microwaves might leak if screws are not properly tightened.
6. Make sure that all electrical connections are tight.
7. Check for microwave energy leakage. Refer to "Measuring For Microwave Radiation Leakage" on Page 6.

# **WARNING**

## **To Avoid Electrical Shock:**

- Disconnect the power to the appliance before servicing.
- For those checks requiring the use of electrical power, exercise extreme care.
- Do not attempt high-voltage tests.

**RESPECT HIGH-VOLTAGE**

# PROCEDURE FOR MEASURING MICROWAVE RADIATION LEAKAGE



## WARNING

Check for microwave radiation leakage before and after every servicing. Should the leakage be more than  $5 \text{ mw/cm}^2$  inform Thermador immediately. After repairing or replacing any radiation safety device, keep a written record for future reference, as required by D.H.H.S. regulations. This requirement must be strictly observed. In addition, the leakage reading must be recorded on the service repair ticket while in the customer's home.

**NOTE:** The maximum allowable leakage according to U.S. Government standard is  $5 \text{ mw/cm}^2$  while in the customer's home. Using  $4 \text{ mw/cm}^2$  as the highest acceptable meter reading, allows for meter and probe accuracy tolerances.

### Equipment:

Holiday model 1501 or equivalent meter.

Glass thermometer,  $212^\circ \text{ F.}$  or  $100^\circ \text{ C.}$

600 cc glass beaker.

Before performing any tests, be sure to observe the following precautions:

- Do not exceed the meter's full-scale deflection. Leakage monitor should initially be set to the highest scale.
- To prevent false readings, hold the test probe by the grip portion of the handle only, and move it along the shaded area shown in the following illustration.
- Meter reading with the top panel removed should be less than  $4 \text{ mw/cm}^2$ .
- Meter reading for fully assembled oven, with the door normally closed should be less than  $4 \text{ mw/cm}^2$ .
- Meter reading for fully assembled oven, before the latch switch (primary) is interrupted while lightly pulling on the door, should be less than  $4 \text{ mw/cm}^2$ .

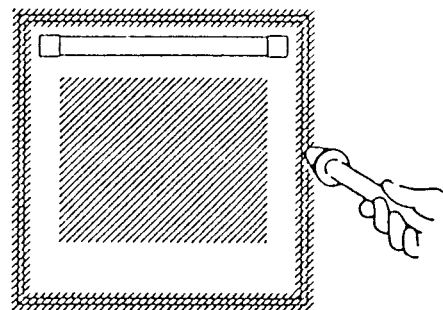



## PROCEDURE FOR MEASURING MICROWAVE RADIATION LEAKAGE, continued



### WARNING

Avoid contacting any high-voltage parts.

**I. Pour  $275 \pm 15$  cc (9 oz.  $\pm 1/2$  OZ.) of  $20 \pm 5^\circ\text{C}$  ( $68 \pm 9^\circ\text{F}$ ) water in a beaker, graduated to 600 cc, and place the beaker in the center of the oven.**

**2. Set the radiation monitor to 2450 MHz, and follow the manufacturer's recommended test procedure to assure correct results.**

**NOTE:** When measuring the leakage, always use the 2 inch (5 cm) spacer supplied with the probe.

**3. Start the magnetron and measure the leakage** by holding the probe perpendicular to the surface being measured.

**4. Measuring With The Top Panel Removed** — Whenever you replace the magnetron, measure for radiation leakage before the top panel is installed and after all necessary components are replaced or adjusted. Special care should be taken in measuring around the magnetron.

**5. Measuring A Fully Assembled Oven** After all components, including the top panel, are fully assembled, measure for radiation leakage around the (door periphery and the door viewing window).

**6. Record keeping and notification after measurement.** Take a leakage reading after any adjustment or repair to a microwave oven. Record this leakage on the repair ticket, even if it is zero. A copy of this repair ticket and the microwave oven leakage reading should be kept by the repair facility.

If the radiation leakage is more than  $5\text{mw}/\text{cm}^2$  after determining that all parts are in good condition and functioning properly, and that genuine replacement parts, as listed in this manual, have been used, immediately notify Thermador and inform the owner that the microwave cannot be used.

**7. At least once a year, have the radiation monitor calibrated by its manufacturer.**

## THERMADOR® WARRANTY

Length of Warranty	Thermador will pay for:	Thermador will not pay for:
<p><b>FULL ONE YEAR</b>                      For one year from date of installation or date of occupancy for a new previously unoccupied dwelling. Save all dated receipts or other evidence of date of installation/occupancy date.</p>	<p>All repair labor and replacement parts found to be defective due to materials and workmanship. Service must be provided by a Factory Authorized Service Agency, during normal working hours. For a Service Agency nearest you, please call: 1-800/735-4328.</p>	<ol style="list-style-type: none"> <li>1. Service by an unauthorized agency. Damage or repairs by an unauthorized agency or use of unauthorized parts.</li> <li>2. Service visits to:                             <ul style="list-style-type: none"> <li>• Teach you how to use the appliance.</li> <li>• Correct the installation. You are responsible for providing electrical wiring and/or gas installation and other connecting facilities.</li> <li>• Reset circuit breakers or replace home fuses.</li> </ul> </li> <li>3. Damage caused from accident, abuse, alteration, misuse, incorrect installation or installation not in accordance with local codes, or improper storage of the appliance.</li> <li>4. Repairs due to other than normal home use.</li> </ol>

This warranty applies to appliances used in normal family households; it does not cover their use in commercial situations.

This warranty is for products purchased and retained in the 50 states of the U.S.A., the District of Columbia, and Canada. The warranty applies even if you should move during the warranty period. Should the appliance be sold by the original purchaser during the warranty period, the new owner continues to be protected until the expiration of the original purchaser’s warranty period.

THERMADOR DOES NOT ASSUME ANY RESPONSIBILITY FOR INCIDENTAL OR CONSEQUENTIAL DAMAGES. Some states do not allow the exclusions or limitation of incidental or consequential damages, so the above limitation or exclusion may not apply to you. This warranty gives you specific legal rights. You may also have other rights which vary from state-to-state or province-to-province.

# SERVICING THE COMPONENTS

## COMPONENT LOCATIONS

The serviceable components for the upper (or single) oven and plenum are included in this section of the manual. The components are

shown below. Refer to the pages that show the components you wish to service.

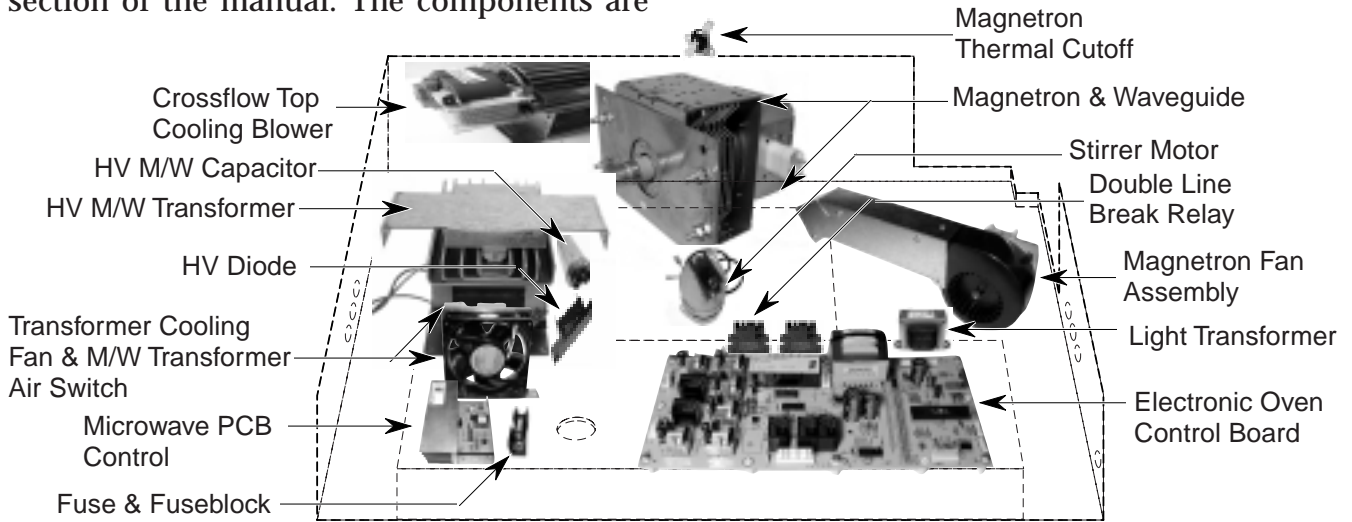

### TOP PLENUM COMPONENTS

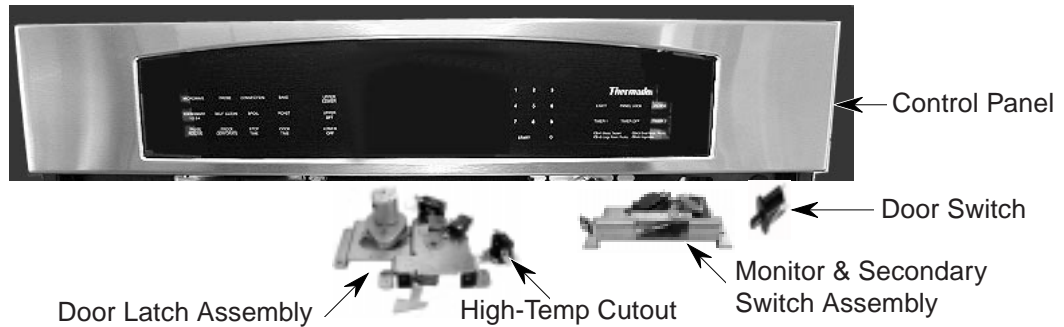

### FRONT COMPONENTS

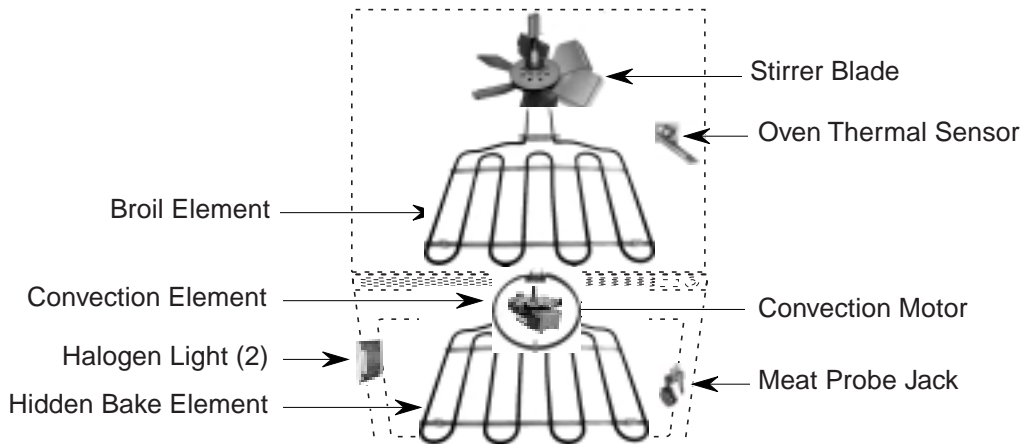

### UPPER (OR SINGLE) OVEN COMPONENTS

## REMOVING THE TRIM, AND TOP PLENUM COVERS

### **⚠ WARNING**

Turn off the electrical power going to the oven before servicing.

### **⚠ CAUTION**

When you work on the oven, be careful when handling the sheet metal parts. There are sharp edges present and you can cut yourself if you are not careful.

1. Turn off the electrical power going to the oven.
2. Pull the oven out of its mounting location so that you can access the trim and plenum covers.

3. To remove the trim, remove the two end screws.
4. To remove the top front plenum cover:
  - a) Remove the five screws.
  - b) Pull the cover forward and remove it.
5. To remove the top rear plenum cover, remove the eight screws and lift it off the oven.

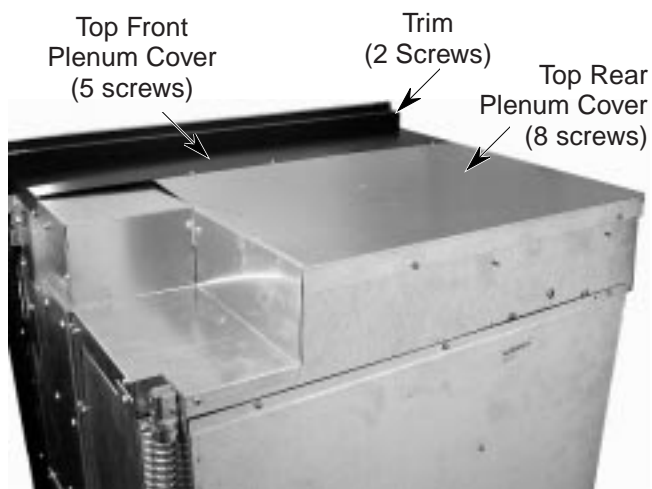

# REMOVING THE ELECTRONIC OVEN CONTROL BOARD

## **⚠ WARNING**

Turn off the electrical power going to the oven before servicing.

## **⚠ CAUTION**

When you work on the oven, be careful when handling the sheet metal parts. There are sharp edges present and you can cut yourself if you are not careful.

1. Turn off the electrical power going to the oven.
2. Pull the oven out of its mounting location so that you can access the trim and plenum covers.
3. Remove the trim and top plenum covers from the oven (see Page 10).
4. Remove the four screws from the control panel mounting bracket, pull the catches out of the ball studs at each end of the bracket, (see the small inset), and remove the bracket from the oven.

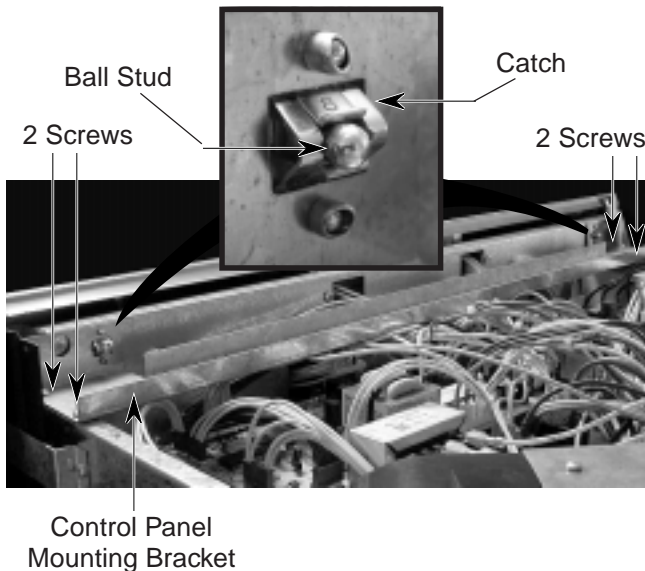

6. Remove the six screws from the electronic oven control board.

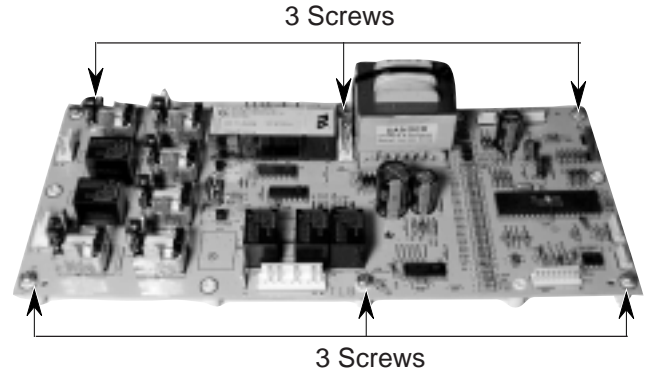

7. Lift the front of the electronic oven control board and slide the three wire ties off the front spacers, then remove the board from the oven.

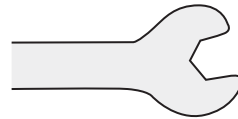
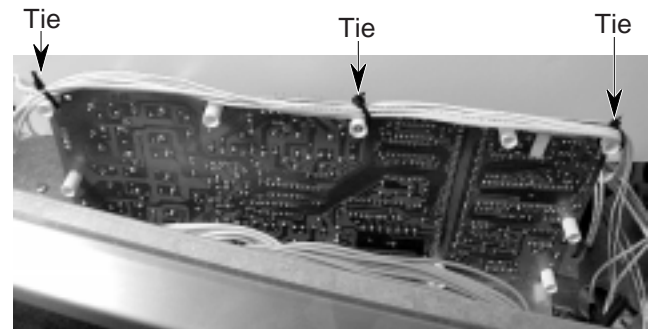

## **Tech Tip!!**

If necessary, refer to Page 113 for the wire connection callouts for single and double electronic oven control boards.

5. Disconnect the wires from the electronic oven control board connectors.

# REMOVING THE FUSEBLOCK & MICROWAVE PCB CONTROL

## ⚠ WARNING

Turn off the electrical power going to the oven before servicing.

## ⚠ CAUTION

When you work on the oven, be careful when handling the sheet metal parts. There are sharp edges present and you can cut yourself if you are not careful.

1. Turn off the electrical power going to the oven.
2. Pull the oven out of its mounting location so that you can access the trim and plenum covers.
3. Remove the trim and top plenum covers from the oven (see Page 10).
4. Remove the control panel mounting bracket (see Step 4 on Page 11).
5. **To remove the fuseblock:**
  - a) Pull the fuse out of the clips.
  - b) Remove the mounting screw from the center of the fuseblock.

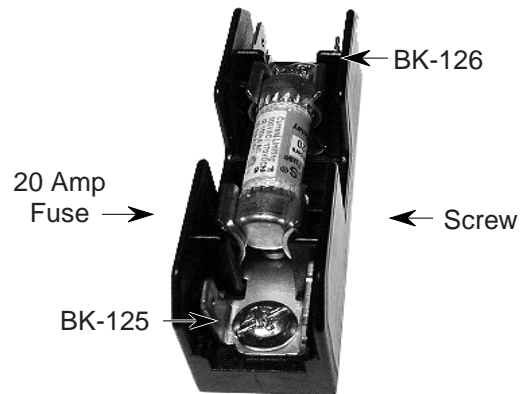

6. **To remove the microwave PCB control:**
  - a) Disconnect the wires from the terminals.
  - b) Remove the four mounting screws from the bracket.

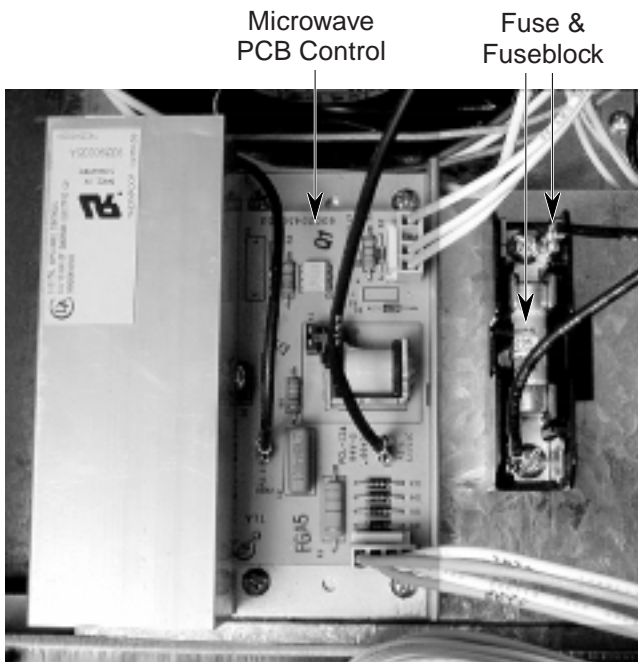
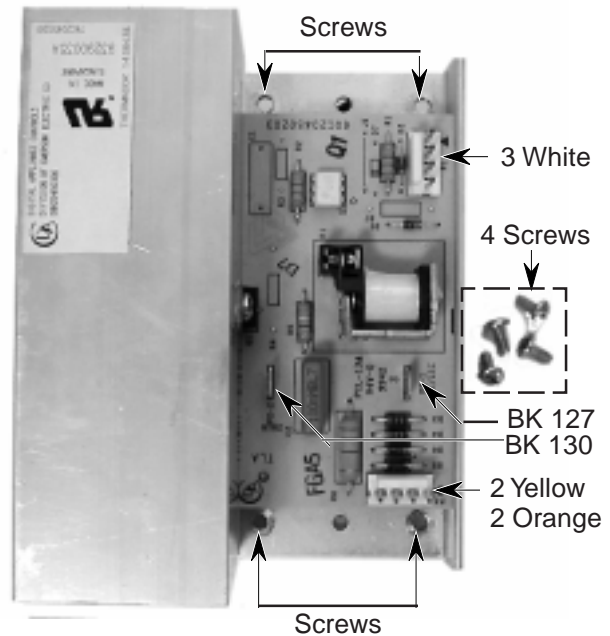



## REMOVING THE STIRRER MOTOR

### **⚠ WARNING**

Turn off the electrical power going to the oven before servicing.

### **⚠ CAUTION**

When you work on the oven, be careful when handling the sheet metal parts. There are sharp edges present and you can cut yourself if you are not careful.

1. Turn off the electrical power going to the oven.
2. Pull the oven out of its mounting location so that you can access the trim and plenum covers.
3. Remove the trim and top plenum covers from the oven (see Page 10).
4. Disconnect the stirrer motor wires from the terminal block and the in-line connector.

5. Remove the two mounting screws from the stirrer motor bracket, lift the motor, and slide the coupling out of the stirrer blade receptacle.

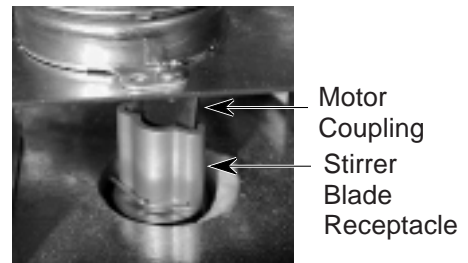
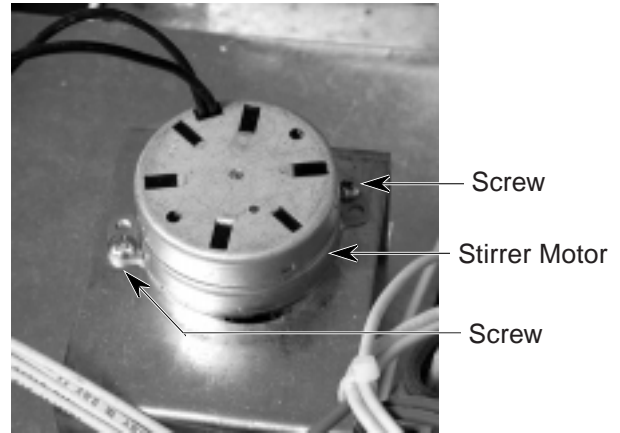
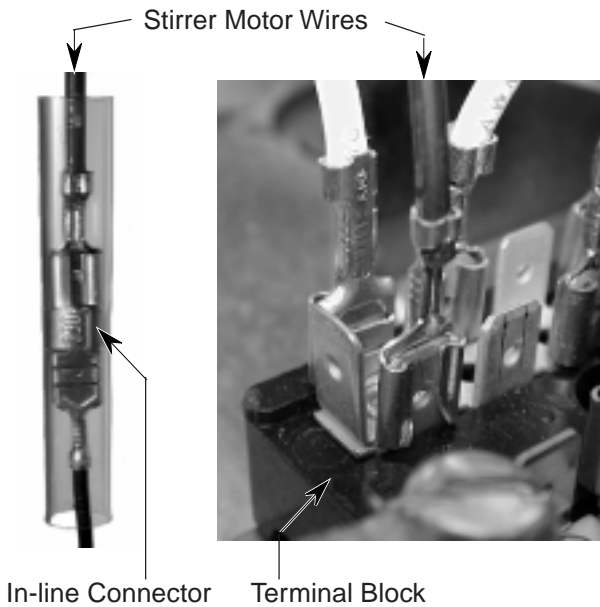



## REMOVING THE TRANSFORMER COOLING FAN AND M/W TRANSFORMER AIR SWITCH ASSEMBLY

### ⚠ WARNING

Turn off the electrical power going to the oven before servicing.

### ⚠ CAUTION

When you work on the oven, be careful when handling the sheet metal parts. There are sharp edges present and you can cut yourself if you are not careful.

1. Turn off the electrical power going to the oven.
2. Pull the oven out of its mounting location so that you can access the trim and plenum covers.
3. Remove the trim and top plenum covers from the oven (see Page 10).
4. **To remove the transformer cooling fan:**
  - a) Disconnect the wires from the terminals.
  - b) Remove the two plenum mounting screws from the bracket.

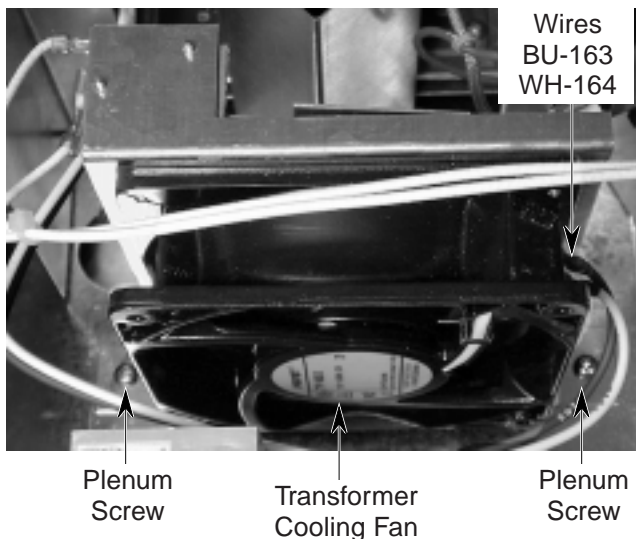

- c) Remove the four fan mounting screws from the bracket.

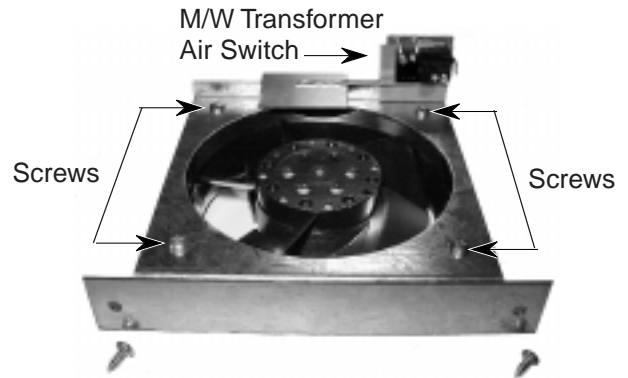

5. **To remove the m/w transformer air switch assembly from the transformer cooling fan:**
  - a) Remove the transformer cooling fan from the plenum (see Step 4).
  - b) Disconnect the wires from the terminals.
  - c) Remove the two mounting screws from the switch body.

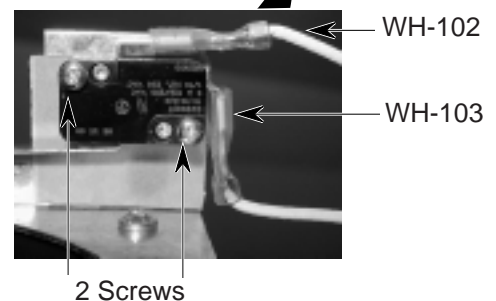
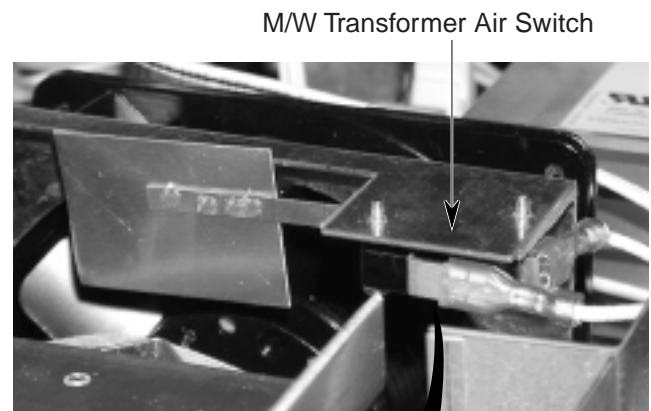

## REMOVING THE MAGNETRON FAN ASSEMBLY

### **⚠ WARNING**

Turn off the electrical power going to the oven before servicing.

### **⚠ CAUTION**

When you work on the oven, be careful when handling the sheet metal parts. There are sharp edges present and you can cut yourself if you are not careful.

1. Turn off the electrical power going to the oven.
2. Pull the oven out of its mounting location so that you can access the trim and plenum covers.
3. Remove the trim and top plenum covers from the oven (see Page 10).

4. Disconnect the wires from the terminals of the magnetron fan assembly.
5. Remove the two fan assembly bracket screws from the plenum and remove the assembly.
6. Remove the two duct screws and slide it off the fan assembly.

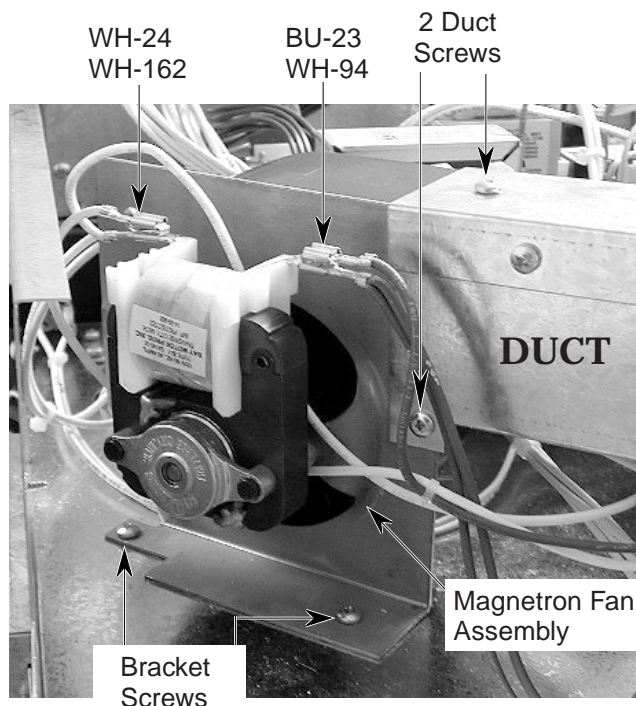

## REMOVING THE CROSSFLOW TOP COOLING BLOWER

### **⚠ WARNING**

Turn off the electrical power going to the oven before servicing.

### **⚠ CAUTION**

When you work on the oven, be careful when handling the sheet metal parts. There are sharp edges present and you can cut yourself if you are not careful.

1. Turn off the electrical power going to the oven.
2. Pull the oven out of its mounting location so that you can access the trim and plenum covers.
3. Remove the trim and top plenum covers from the oven (see Page 10).

4. Disconnect the wires from the terminals of the crossflow top cooling blower.
5. Remove the two screws from the blower mounting bracket and remove the blower from the oven.

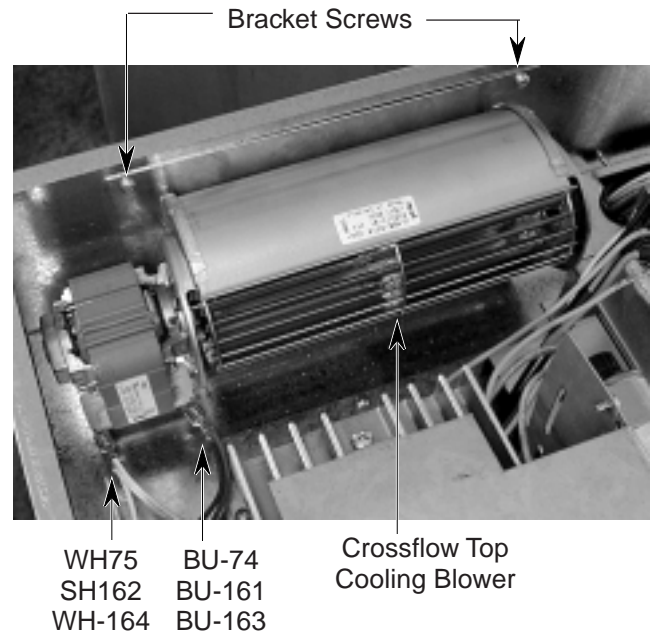

## REMOVING THE HIGH VOLTAGE MICROWAVE CAPACITOR

### **⚠ WARNING**

Turn off the electrical power going to the oven before servicing.

### **⚠ CAUTION**

When you work on the oven, be careful when handling the sheet metal parts. There are sharp edges present and you can cut yourself if you are not careful.

1. Turn off the electrical power going to the oven.
2. Pull the oven out of its mounting location so that you can access the trim and plenum covers.
3. Remove the trim and top plenum covers from the oven (see Page 10).
4. **CAUTION: DISCHARGE THE HIGH VOLTAGE MICROWAVE CAPACITOR WITH A 20,000 OHM, 1- OR 2-WATT RESISTOR TO CHASSIS GROUND BEFORE WORKING ON ANY OF THE HIGH VOLTAGE COMPONENTS. BE VERY CAREFUL NOT TO TOUCH THE BARE RESISTOR LEADS WHEN YOU DISCHARGE THE CAPACITOR.**

5. Disconnect the wires from the terminals of the high voltage microwave capacitor.
6. Remove the capacitor mounting bracket screw and remove the bracket and capacitor from the transformer side shield.

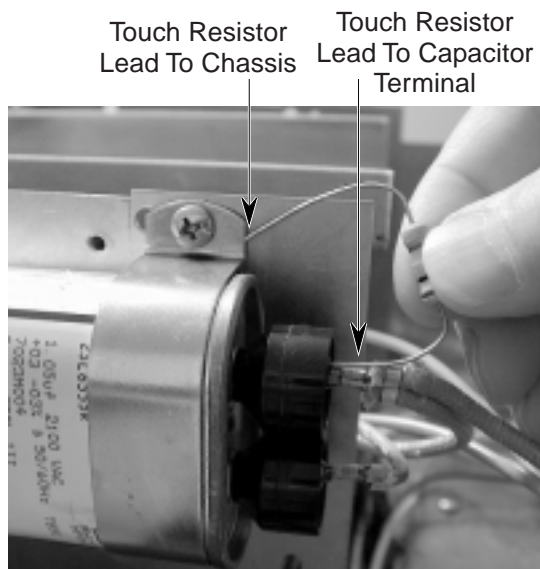
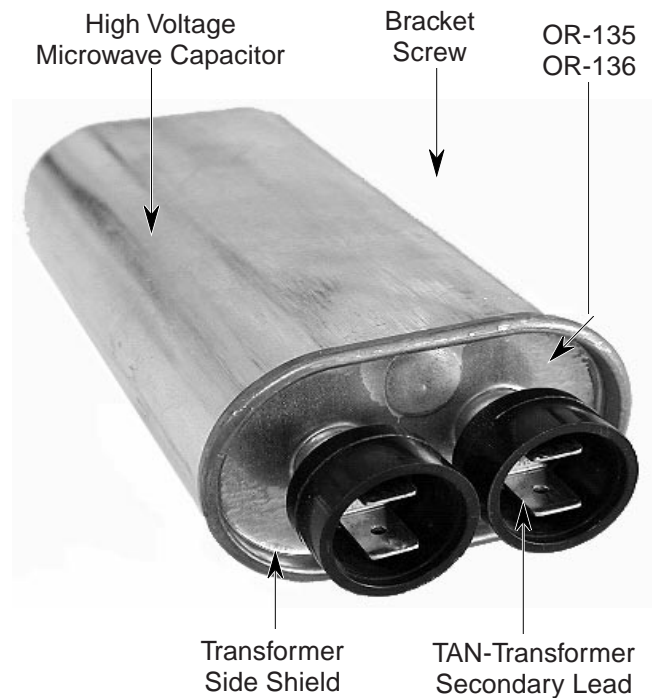

## REMOVING THE HIGH VOLTAGE DIODE

### ⚠ WARNING

Turn off the electrical power going to the oven before servicing.

### ⚠ CAUTION

When you work on the oven, be careful when handling the sheet metal parts. There are sharp edges present and you can cut yourself if you are not careful.

1. Turn off the electrical power going to the oven.
2. Pull the oven out of its mounting location so that you can access the trim and plenum covers.
3. Remove the trim and top plenum covers from the oven (see Page 10).
4. **CAUTION: DISCHARGE THE HIGH VOLTAGE MICROWAVE CAPACITOR WITH A 20,000 OHM, 1- OR 2-WATT RESISTOR TO CHASSIS GROUND (SEE PAGE 18) BEFORE WORKING ON ANY OF THE HIGH VOLTAGE COMPONENTS. BE VERY CAREFUL NOT TO TOUCH THE BARE RESISTOR LEADS WHEN YOU DISCHARGE THE CAPACITOR.**

5. Disconnect the wires from the terminals of the high voltage diode.
6. Remove the mounting screw from the diode and remove the diode from the shield.

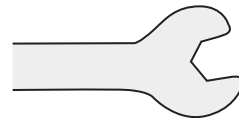
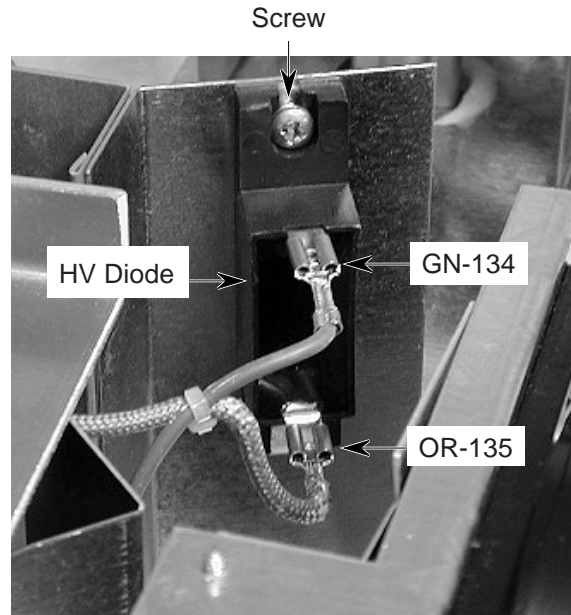

### Tech Tip!!

**IMPORTANT:** Make sure that you position the high voltage diode with the cathode (-) terminal at the top and the anode (+) terminal at the bottom. The diode symbol is shown below and on the side of the diode body.

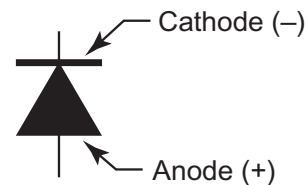

## REMOVING THE HIGH VOLTAGE MICROWAVE TRANSFORMER

### **⚠ WARNING**

Turn off the electrical power going to the oven before servicing.

### **⚠ CAUTION**

When you work on the oven, be careful when handling the sheet metal parts. There are sharp edges present and you can cut yourself if you are not careful.

1. Turn off the electrical power going to the oven.
2. Pull the oven out of its mounting location so that you can access the trim and plenum covers.
3. Remove the trim and top plenum covers from the oven (see Page 10).
4. **CAUTION: DISCHARGE THE HIGH VOLTAGE MICROWAVE CAPACITOR WITH A 20,000 OHM, 1- OR 2-WATT RESISTOR TO CHASSIS GROUND (SEE PAGE 18) BEFORE WORKING ON ANY OF THE HIGH VOLTAGE COMPONENTS. BE VERY CAREFUL NOT TO TOUCH THE BARE RESISTOR LEADS WHEN YOU DISCHARGE THE CAPACITOR.**
5. Disconnect the three high voltage microwave transformer leads from the terminals of the high voltage capacitor and the magnetron.

6. Remove the four mounting screws from the heat sink bracket and remove the bracket from the top of the transformer.

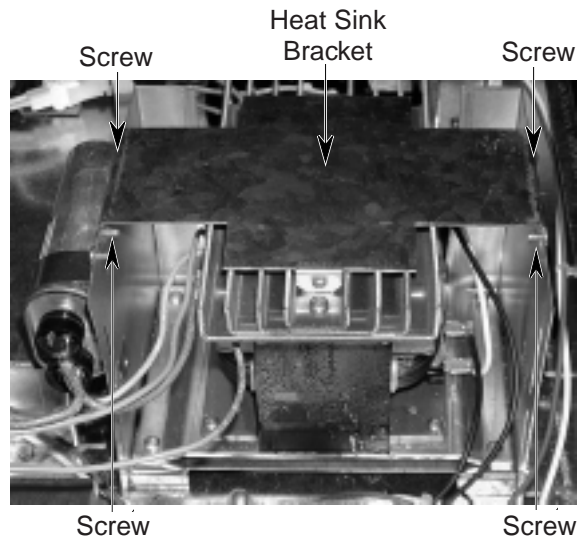

7. Remove the two mounting screws from the heat sink and remove the sink from the top of the transformer.

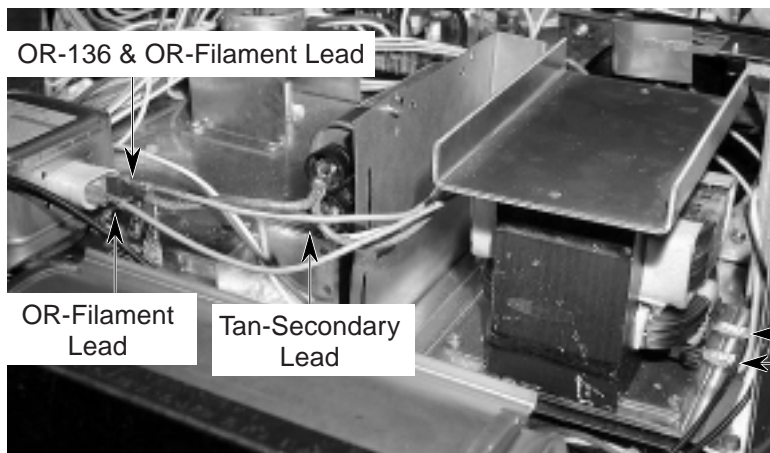
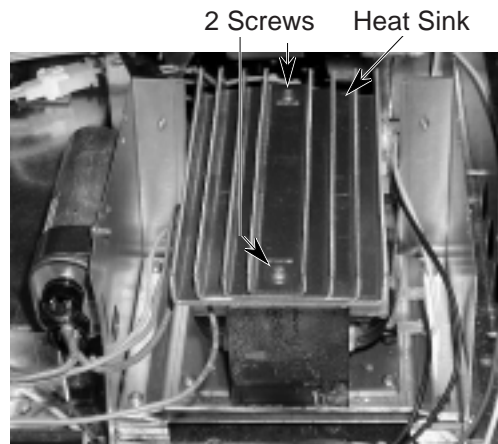

8. Remove the four mounting screws from the high voltage microwave transformer and remove the transformer from the oven.

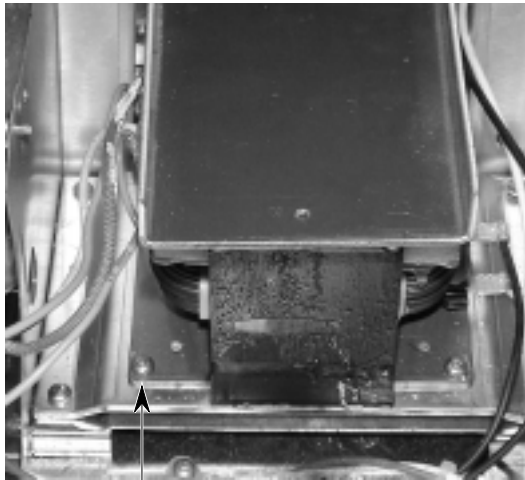

Screw (1 of 4)

9. Remove the heat sink plate from the top of the high voltage microwave transformer.
10. Apply a liberal amount of heat sink paste over the top of the new transformer, then place the heat sink plate in the center of the transformer and press it down so it adheres firmly.

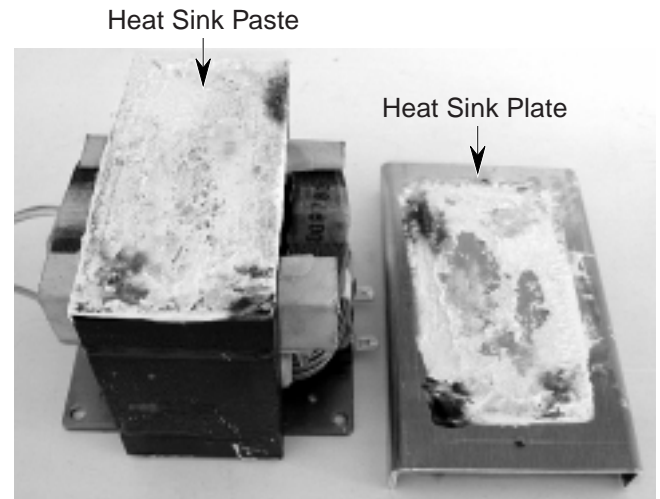

## REMOVING THE MAGNETRON, & MAGNETRON THERMAL CUTOUT

### **⚠ WARNING**

Turn off the electrical power going to the oven before servicing.

### **⚠ CAUTION**

When you work on the oven, be careful when handling the sheet metal parts. There are sharp edges present and you can cut yourself if you are not careful.

1. Turn off the electrical power going to the oven.
2. Pull the oven out of its mounting location so that you can access the trim and plenum covers.
3. Remove the trim and top plenum covers from the oven (see Page 10).
4. **CAUTION: DISCHARGE THE HIGH VOLTAGE MICROWAVE CAPACITOR WITH A 20,000 OHM, 1- OR 2-WATT RESISTOR TO CHASSIS GROUND (SEE PAGE 18) BEFORE WORKING ON ANY OF THE HIGH VOLTAGE COMPONENTS. BE VERY CAREFUL NOT TO TOUCH THE BARE RESISTOR LEADS WHEN YOU DISCHARGE THE CAPACITOR.**
5. Remove the two screws from the magnetron fan duct and remove the duct.

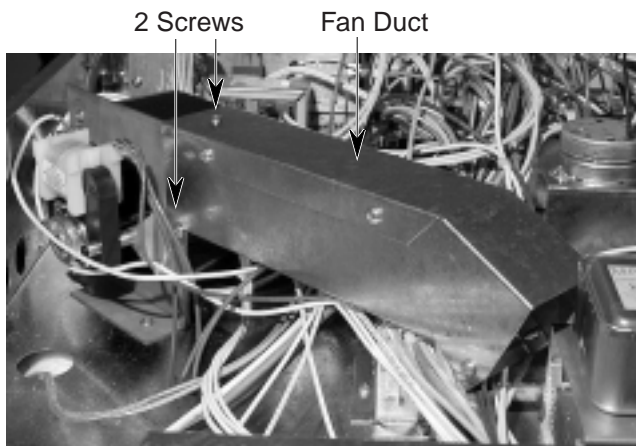

6. To remove the magnetron:
  - a) Disconnect the wires from the two terminals.
  - b) Remove the two screws from the vent cover and remove the cover.

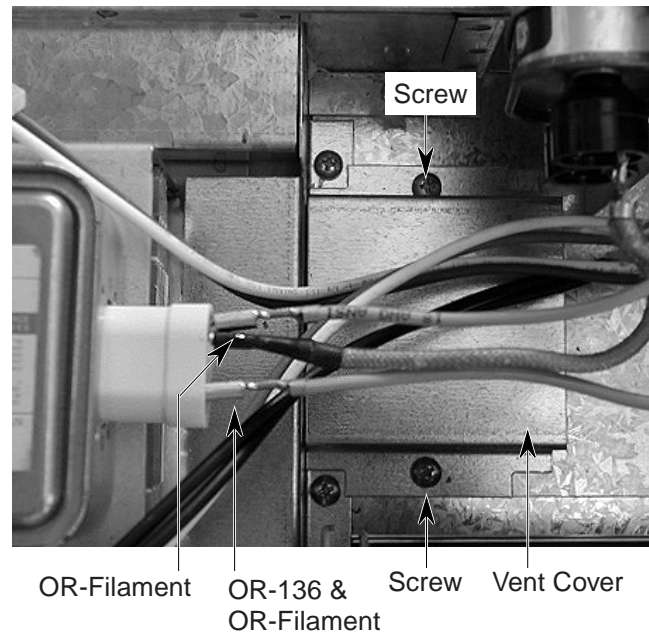

- c) Remove the mounting screws (two each) from the left and right waveguide insulation covers and remove the covers.

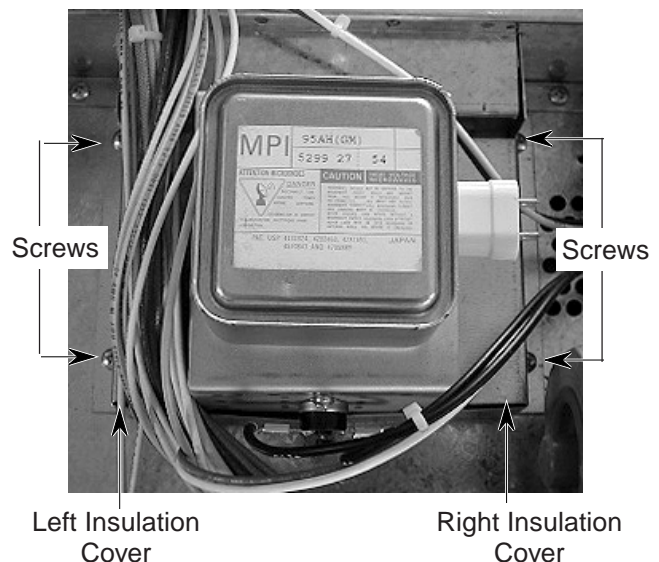



- d) Remove the two pieces of insulation from the top of the waveguide.

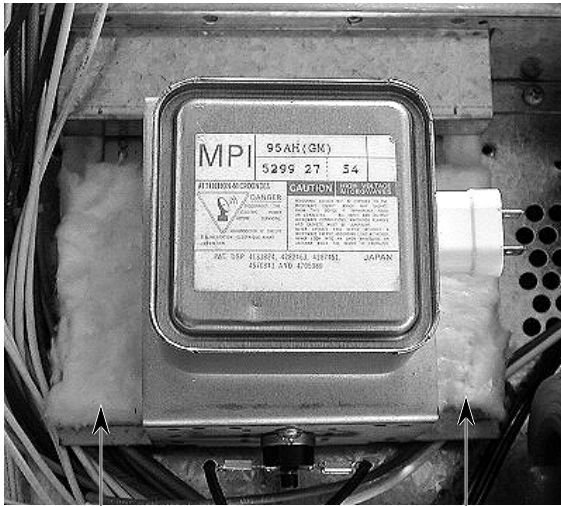

Insulation Insulation

- e) Remove the four mounting screws from the magnetron and lift it off the waveguide.

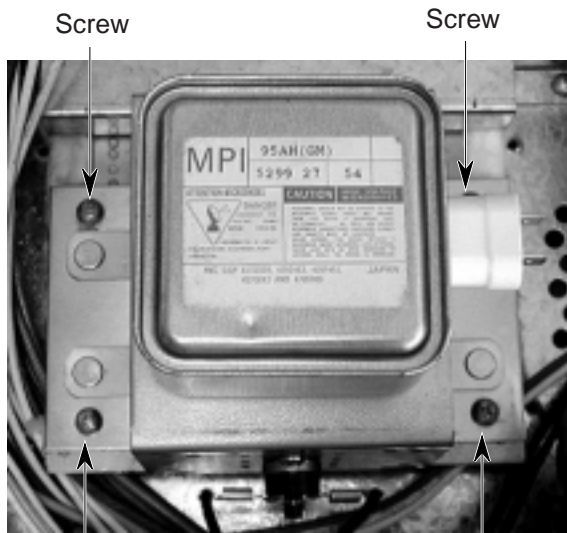

Screw Screw

7. To reinstall the magnetron on the waveguide, use the cross-tightening method to tighten the four screws, as follows:

- a) Loosely install screw #1.
- b) Loosely install screw #2 in an alternate (across the transformer) mounting hole.

- c) Repeat steps a and b for screws #3 and #4 so that all four screws are loosely installed.
- d) Alternately tighten screws #1 through #4 until they are snug. The base of the magnetron should be perfectly parallel with the waveguide to operate properly.

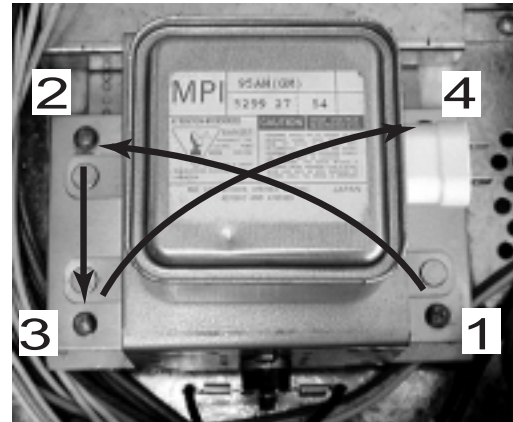

8. To remove the magnetron thermal cut-out:

- a) Disconnect the wires (BK-130 & BK131) from the terminals.
- b) Remove the two screws.

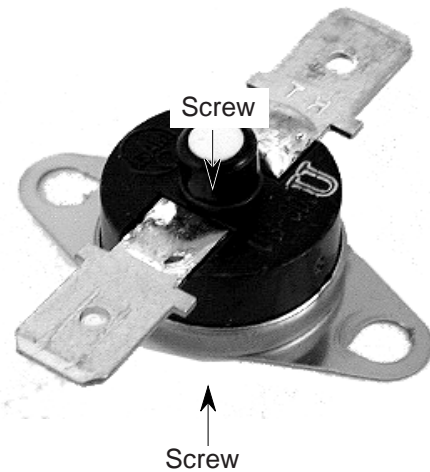

## REMOVING THE CONTROL PANEL ASSEMBLY, DISPLAY BOARD, & TOUCH PANEL GLASS

### **⚠ WARNING**

Turn off the electrical power going to the oven before servicing.

### **⚠ CAUTION**

When you work on the oven, be careful when handling the sheet metal parts. There are sharp edges present and you can cut yourself if you are not careful.

1. Turn off the electrical power going to the oven.
2. Open the microwave oven door.
3. **To remove the control panel assembly:**
  - a) Remove the four outer black screws from the bottom of the control panel assembly.



4 Black Control Panel Screws

- b) Pull the top of the control panel forward and unhook the two ball studs at the top right and left corners from the catches.
  - c) Disconnect the five cables from the control panel board connectors at P2, P4, P6, P10, and P11 and remove the assembly.
4. **To remove the display board and touch panel glass:**
  - a) If not already done, remove the control panel assembly from the oven (see Step 3).
  - b) Place the control panel assembly face-down on a padded work surface to prevent scratching the finish.

- c) Disconnect the cables from the touch panel glass filter board connectors.
  - d) Remove the nine indicated screws from the control panel plate and lift the plate off the control panel.

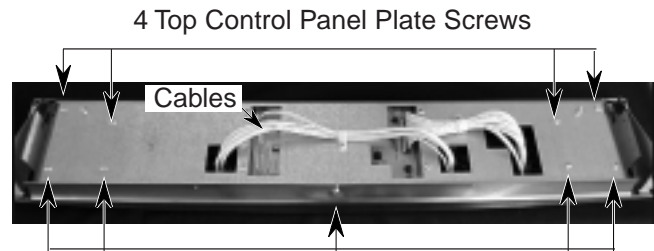

4 Top Control Panel Plate Screws

5 Bottom Control Panel Plate Screws

- e) Lift the display board off the control panel.

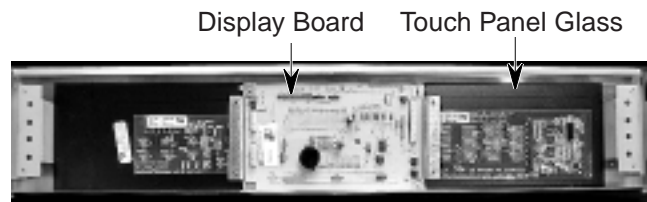

Display Board Touch Panel Glass

- f) Remove the screws from the mounting brackets and remove the brackets from the display board.

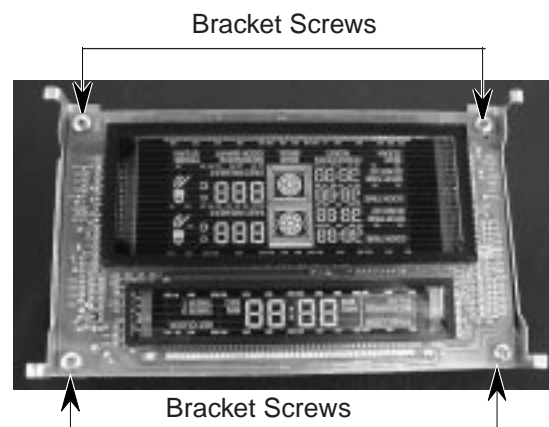

Bracket Screws

Bracket Screws

- g) Lift the touch panel glass (with filter boards) out of the control panel frame.

## REMOVING THE UPPER (OR SINGLE) OVEN DOOR SWITCH

### **WARNING**

Turn off the electrical power going to the oven before servicing.

### **CAUTION**

When you work on the oven, be careful when handling the sheet metal parts. There are sharp edges present and you can cut yourself if you are not careful.

1. Turn off the electrical power going to the oven.
2. Open the microwave oven door.
3. Remove the four outer black screws from the bottom of the control panel assembly (see Step 3, Page 24).
4. Remove the two black screws that are holding the upper latch plate to the front of the upper door latch assembly.



Upper Latch Plate  
2 Black Screws

5. Pull the upper latch plate forward and push the oven door switch out of the mounting hole.
6. Disconnect the wires from the oven door switch.

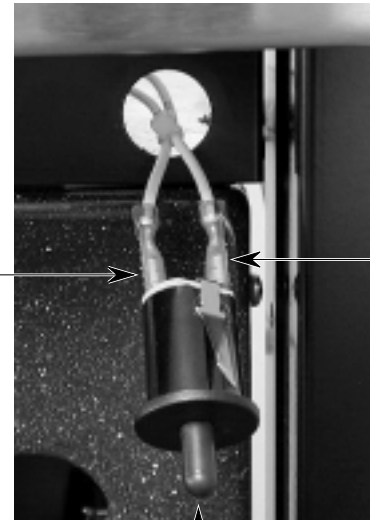

WH-03

WH-04

Oven Door Switch

## REMOVING THE DOOR LATCH ASSEMBLY, HIGH-TEMP CUTOUT, AND THE MONITOR & SECONDARY SWITCH ASSEMBLY

### **⚠ WARNING**

Turn off the electrical power going to the oven before servicing.

### **⚠ CAUTION**

When you work on the oven, be careful when handling the sheet metal parts. There are sharp edges present and you can cut yourself if you are not careful.

1. Turn off the electrical power going to the oven.
2. Open the microwave oven door.
3. Remove the four outer black screws from the bottom of the control panel assembly.

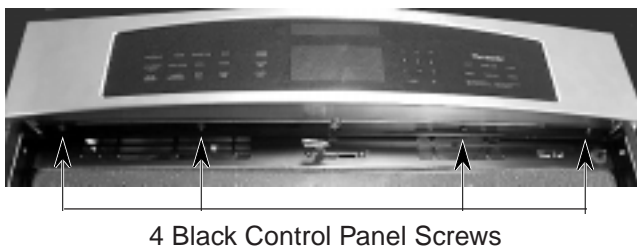

4. Remove the two black screws that are holding the upper latch plate to the front of the upper door latch assembly.

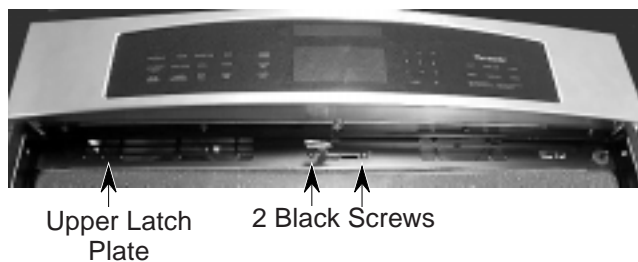

5. Pull the upper latch plate forward and position it off to the side.
6. Pull the top of the control panel forward and unhook the two ball studs at the top right and left corners from the catches.

7. Disconnect the five cables from the touch glass filter board connectors at P2, P4, P6, P10, and P11 and remove the control panel assembly.

NOTE: The door latch assembly and the monitor and secondary switch assembly must each be replaced as an assembly. Individual parts are not available.

8. To remove the door latch assembly:
  - a) Use an angled 1/4" socket and remove the two hex-head screws from the front of the door latch assembly. Pull the assembly forward as far as the wires will allow.
  - b) Disconnect the wires from the latch motor and switches.

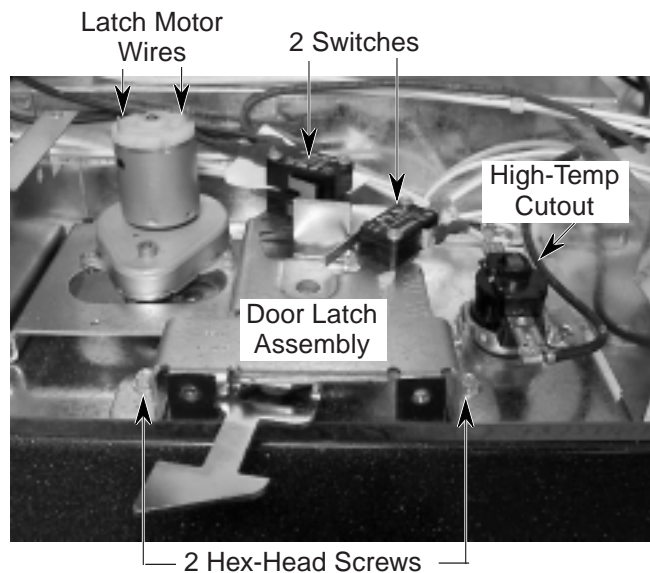

NOTE: The M/W oven door latch motor is activated by 12-volts D.C. through a series of diodes on the electronic oven control board (see Page 60). This motor locks the microwave oven door faster than the lower oven motor.

9. To remove the high-temp cutout:

- a) Use an angled 1/4" socket and remove the two hex-head screws from the high-temp cutout bracket. Pull the cut-out forward as far as the wires will allow.
- b) Disconnect the wires from the terminals.

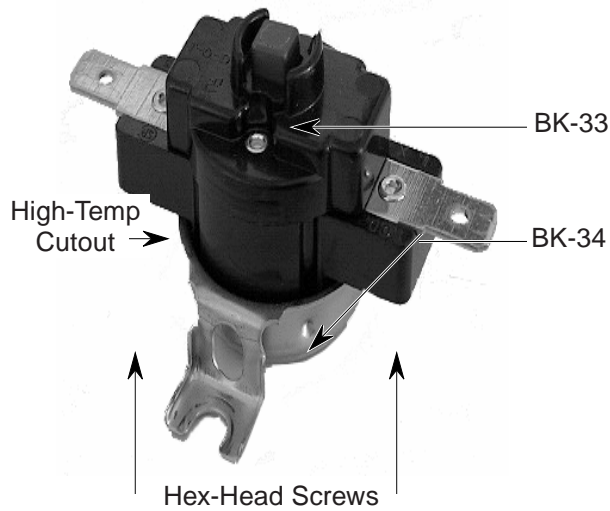

10. To remove the monitor and secondary switch assembly:

- a) Use an angled screwdriver and remove the four screws and lockwashers from the switch assembly. Pull the assembly forward as far as the wires will allow.
- b) Disconnect the wires from the switch terminals.

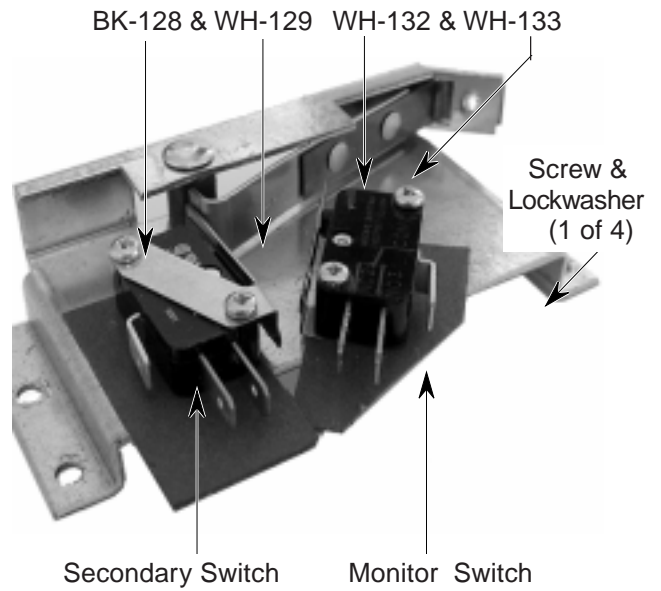

## REMOVING A HALOGEN LIGHT ASSEMBLY

### **⚠ WARNING**

Turn off the electrical power going to the oven before servicing.

### **⚠ CAUTION**

When you work on the oven, be careful when handling the sheet metal parts. There are sharp edges present and you can cut yourself if you are not careful.

1. Turn off the electrical power going to the oven.
2. To make servicing inside the oven easier, remove the microwave oven door (see Page 42 for the procedure).
3. Remove the oven racks.
4. Remove the screws from the rack support that is over the halogen light you wish to service.

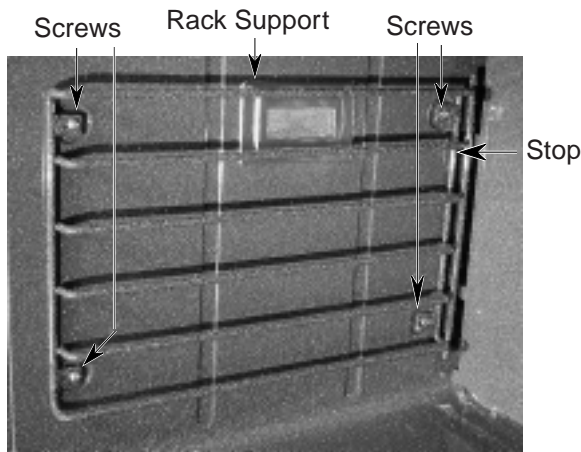

**CAUTION:** When you remove the halogen lens holder and lens in the next step, be careful that the lens does not fall out and break.

5. Remove the four screws from the halogen lens holder and remove the holder and lens from the oven liner.

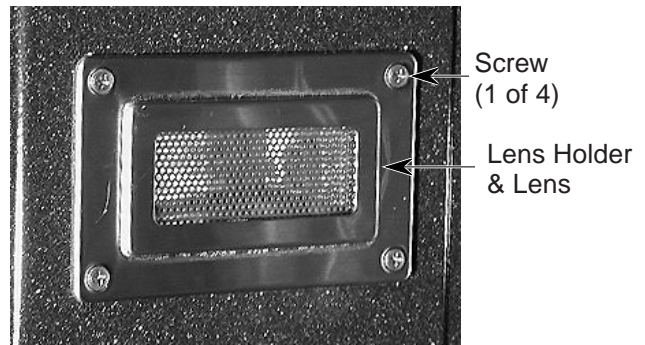

6. Remove the screws from the metal screen that is over the halogen light and remove the screen.

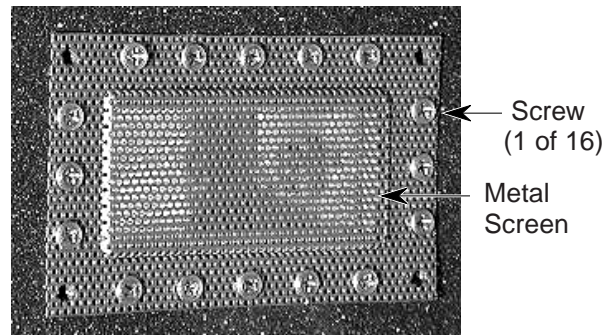

7. Pull the light assembly out of the oven liner cutout and remove the halogen bulb from the socket.

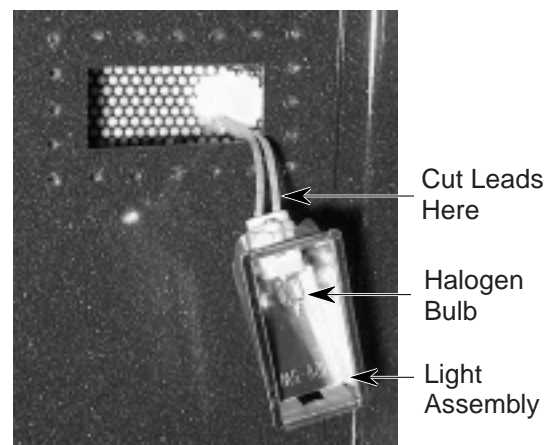

8. Cut the leads that are coming from the light socket near the socket body.

9. Cut the leads of the new light assembly approximately 3" from the body.
10. Remove 3/8" of insulation from the cut lead ends and the wiring harness.
11. Twist two small wire nuts over the ends of the leads.

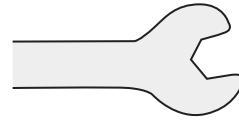

## Tech Tips!!

When you reassemble the halogen light assembly:

1. Position the wiring neatly inside the oven liner cutout for the halogen light and press the assembly into place so its edges are flush with the outside of the liner.

Keep Edges  
Flush With Liner

Install Halogen Bulb

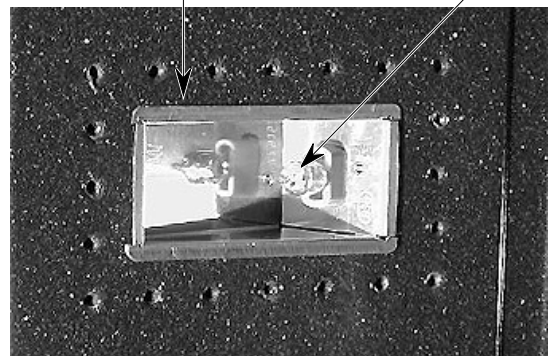

2. Install the bulb in the socket.
3. When you reinstall the metal screen, do not install screws at the four corners (see Step 6 on the previous page).
4. When you reinstall the rack support, make sure you position it with the stop towards the back (see Step 4 on the previous page).

## REMOVING THE BROIL ELEMENT AND STIRRER BLADE ASSEMBLY

### **⚠ WARNING**

Turn off the electrical power going to the oven before servicing.

### **⚠ CAUTION**

When you work on the oven, be careful when handling the sheet metal parts. There are sharp edges present and you can cut yourself if you are not careful.

1. Turn off the electrical power going to the oven.
2. To make servicing inside the oven easier, remove the microwave oven door (see Page 42 for the procedure).
3. Remove the oven racks.
4. **To remove the broil element:**
  - a) Remove the two front and six rear screws from the broil element.

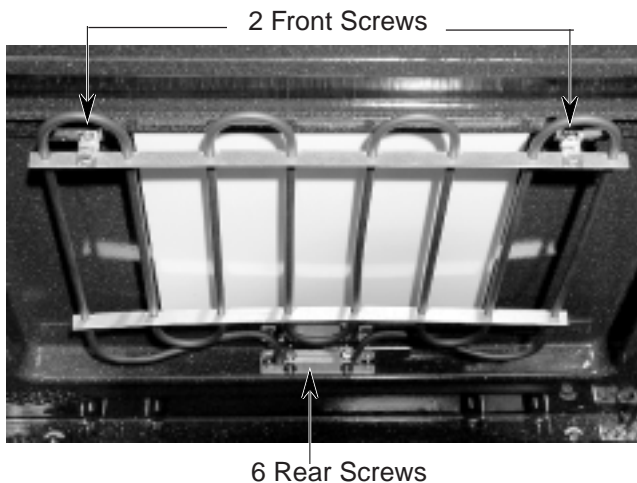

- b) Carefully pull the broil element forward so that the terminals and wires slide through the holes in the liner. **NOTE:** Be careful not to pull the element too hard so that you disconnect the wires from the terminals. If this happens, you may have to remove the rear panel from the oven to retrieve the wiring.

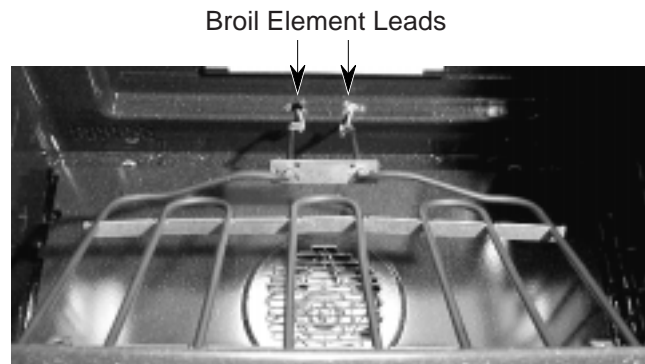

5. **To remove the stirrer blade assembly:**
  - a) If not already done, remove the broil element (refer to Step 4).

**CAUTION:** When you remove the stirrer glass in the next step, be careful that it does not fall and break when the bracket is removed.



- b) Remove the two screws from the stirrer glass bracket, and remove the bracket and glass.

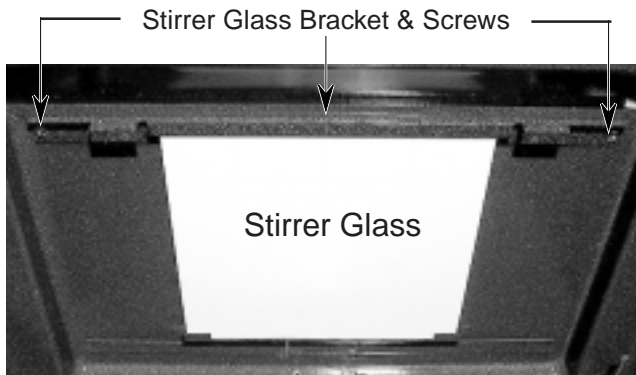

- c) Using one of the mounting screw access holes in the stirrer blade, remove the eight screws from the stirrer blade assembly and remove the assembly.

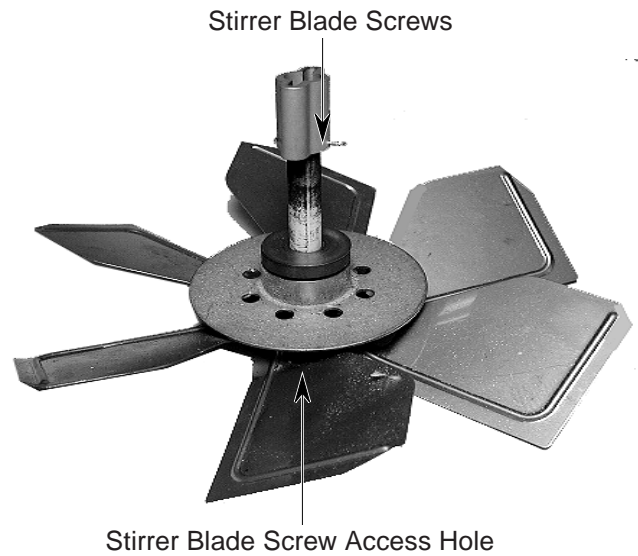

## REMOVING THE WAVEGUIDE

### WARNING

Turn off the electrical power going to the oven before servicing.

### CAUTION

When you work on the oven, be careful when handling the sheet metal parts. There are sharp edges present and you can cut yourself if you are not careful.

1. Turn off the electrical power going to the oven.
2. To make servicing inside the oven easier, remove the microwave oven door (see Page 42 for the procedure).
3. Remove the oven racks.
4. If not already done, remove the broil element, (refer to Step 4 on Page 30), and the stirrer blade assembly, (refer to Step 5 on Page 30).
5. Remove the two screws from the waveguide insulator and remove the insulator.



6. Remove the waveguide screws (#14-91-142).

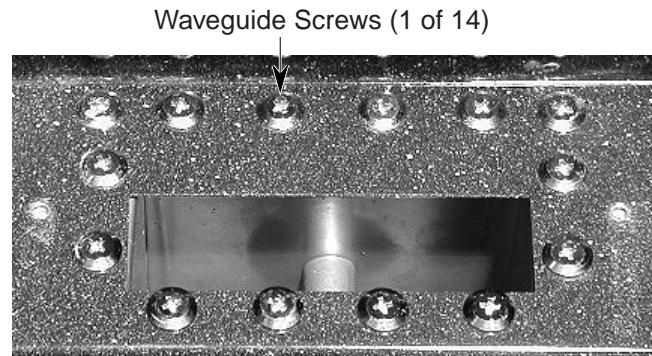

7. Refer to Page 22 and remove the magnetron, as instructed.
8. Remove the high voltage capacitor bracket, and lay the capacitor on top of the microwave transformer so you can access the screw underneath it.
9. Remove the six screws (3 on each side) from the stirrer motor platform.

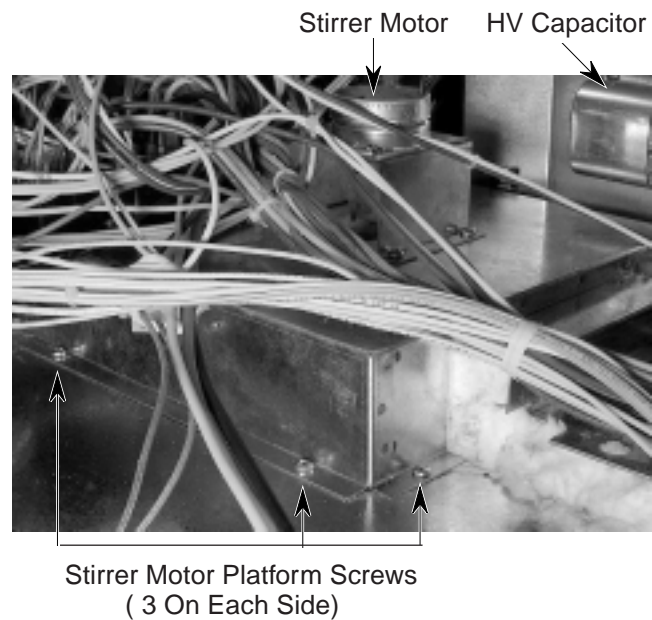

- 10. Lift the back of the stirrer motor platform just high enough to remove the waveguide from underneath it.

Raise Stirrer Motor Platform      Lift Waveguide

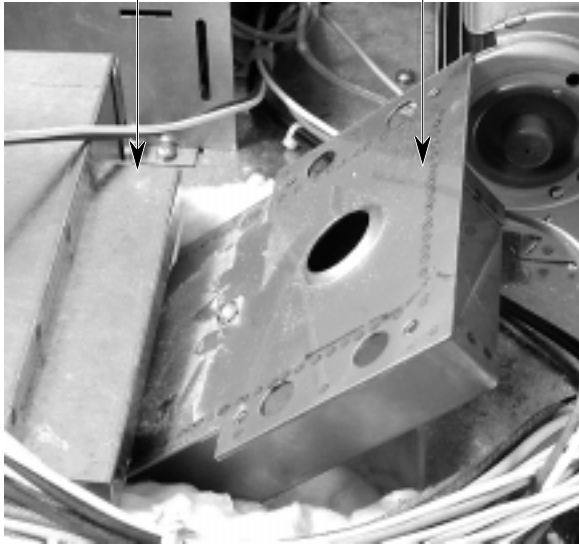

- 11. Clear any insulation away from the area that the waveguide will be mounted in so that the screw holes will align properly when the waveguide is installed.

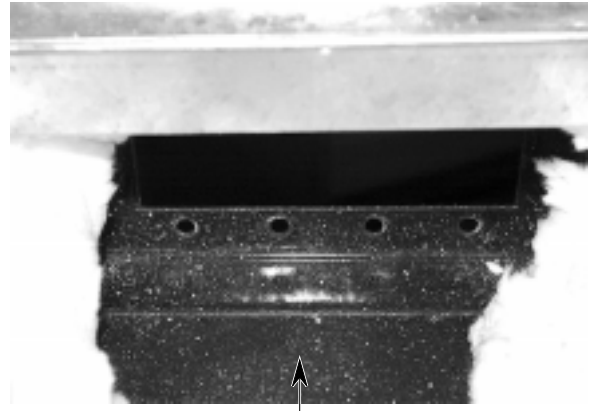

Clear Insulation From This Area

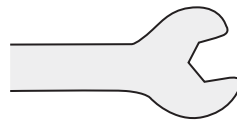

## Tech Tip!!

**IMPORTANT:** Make sure that you reinstall the magnetron as instructed on Page 23.

## REMOVING THE CONVECTION ELEMENT & CONVECTION MOTOR

### **⚠ WARNING**

Turn off the electrical power going to the oven before servicing.

### **⚠ CAUTION**

When you work on the oven, be careful when handling the sheet metal parts. There are sharp edges present and you can cut yourself if you are not careful.

1. Turn off the electrical power going to the oven.
2. To make servicing inside the oven easier, remove the microwave oven door (see Page 42 for the procedure).



## Service Alert!!

After reinstalling the oven door, check around the door for microwave radiation leakage.

3. Remove the oven racks and supports.
4. Remove the four screws and two top insulator (mica) washers from the convection baffle and remove the baffle.

Baffle Screws With Insulator Washers

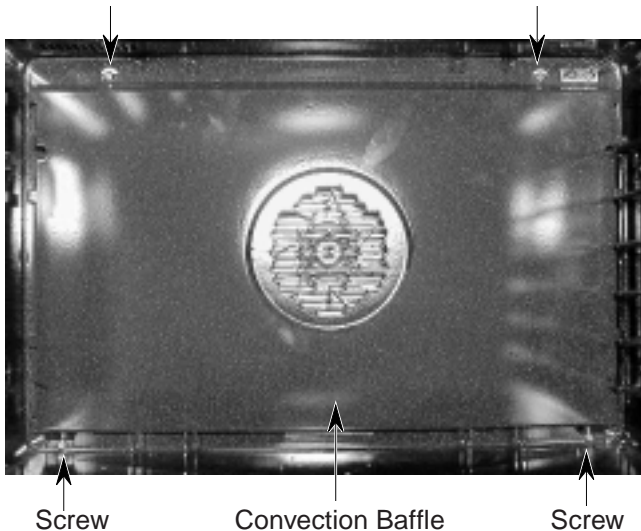

5. To remove the convection element:
  - a) Remove the eight screws from the convection element.

8 Screws      Convection Element

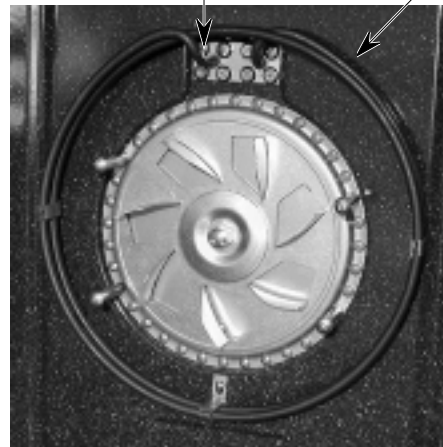

- b) Pull the element forward until the terminal wires are inside the oven (the element terminals and wires are angled up 90°). Disconnect the two wires from the terminals and remove the element.

Convection Element Wires

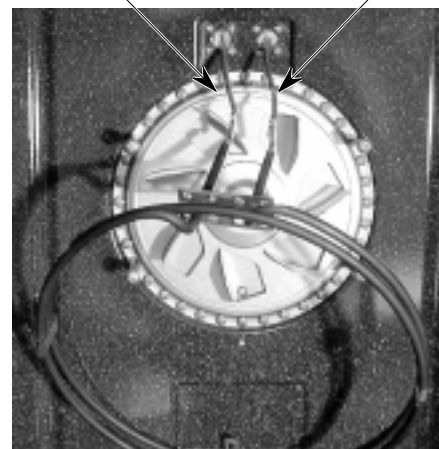

**NOTE:** It will be necessary to pull the oven out of the cabinet to replace the convection motor.

6. To remove the convection motor:

- a) Remove the nut from the convection fan blade and remove the blade and flat washer from the motor shaft.

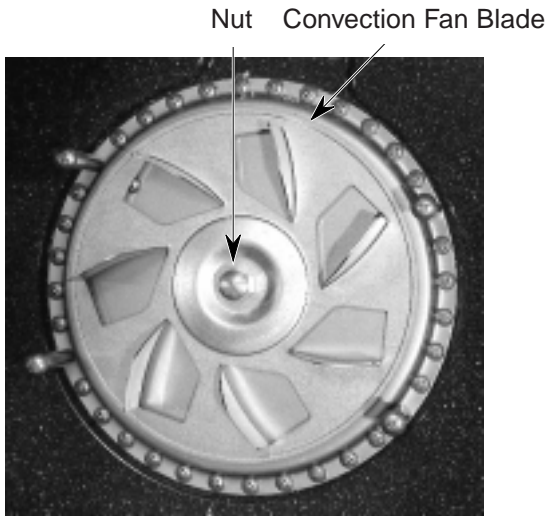

- b) **CAUTION:** The rear shield cover plate is sealed and tested for microwave emissions at the factory. **DO NOT REMOVE THIS SHIELD COVER.**

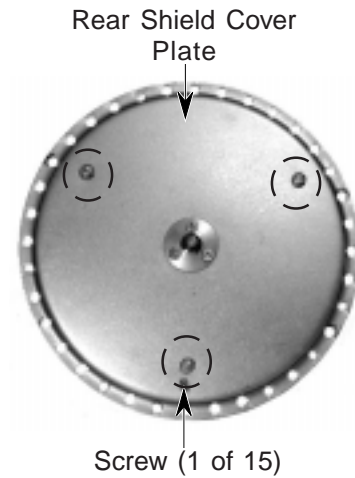

- c) Remove the 15 motor mounting screws from the rear shield cover plate and remove the plate.
- d) Motor and bracket assembly can now be removed from the back of the oven.

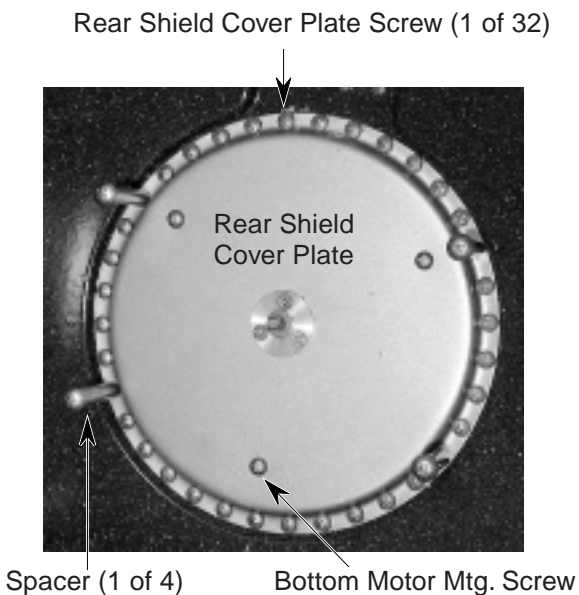

Continued on the next page.

- e) Remove the insulation from the motor and convection motor bracket.

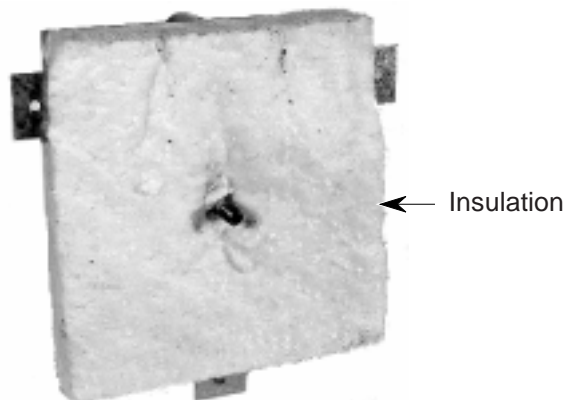

- f) Remove the three screws from the convection motor bracket and remove the bracket from the motor.

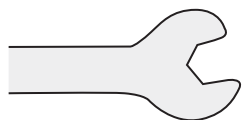
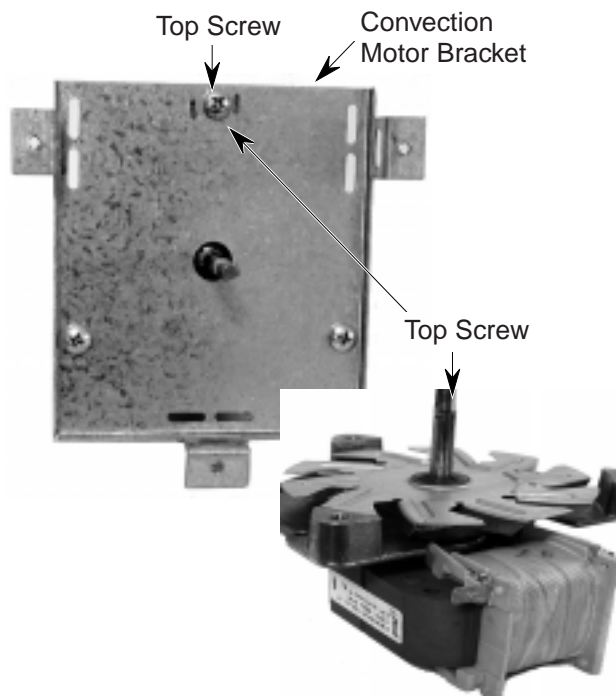

## Tech Tip!!

1. After the fan blade is reassembled, spin the blade to assure that there is no interference with the wires in the rear.

## REMOVING THE MEAT PROBE JACK

### **⚠ WARNING**

Turn off the electrical power going to the oven before servicing.

### **⚠ CAUTION**

When you work on the oven, be careful when handling the sheet metal parts. There are sharp edges present and you can cut yourself if you are not careful.

1. Turn off the electrical power going to the oven.
2. Pull the oven out of its mounting location just far enough so that you can access the meat probe jack access panel on the right side of the oven.
3. Open the microwave oven door.
4. Raise the cover on the meat probe jack, then use a 17 mm (11/16") socket, and remove the hex nut.



5. Remove the screw from the meat probe jack access panel on the right side of the oven.

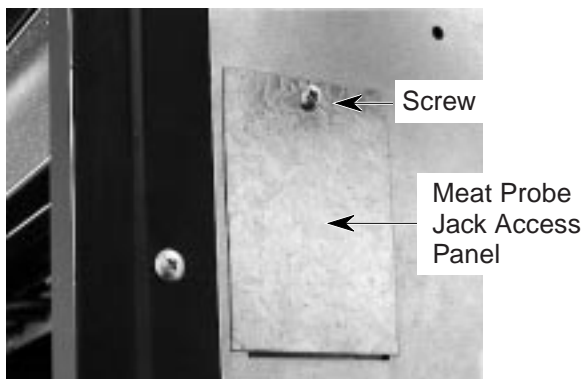

6. Remove the piece of insulation that is covering the meat probe jack.
7. Pull the meat probe jack and flat washer out of the cutout and disconnect the two wires from the terminals.

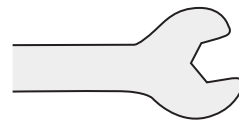
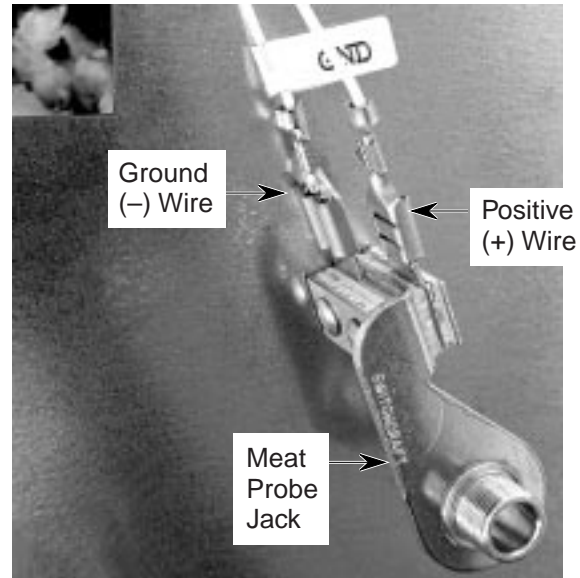

### **Tech Tips!!**

1. Connect the wire with the GND tag on it to the ground terminal on the meat probe jack. This terminal is part of the jack's frame. Be sure to reinstall the flat washer on the jack.
2. To make it easier when reinstalling the hex nut on the jack, place the nut inside the spring cover and close the cover. Thread the nut onto the jack as far as possible by turning the cover, and then tighten it firmly using the socket.

## REMOVING THE HIDDEN BAKE ELEMENT

### **⚠ WARNING**

Turn off the electrical power going to the oven before servicing.

### **⚠ CAUTION**

When you work on the oven, be careful when handling the sheet metal parts. There are sharp edges present and you can cut yourself if you are not careful.

1. Turn off the electrical power going to the oven.
2. Pull the oven out of its mounting location so that you can access the trim and plenum covers.
3. Remove the trim and top plenum covers from the oven (see Page 10).
4. Remove the back cover from the oven.

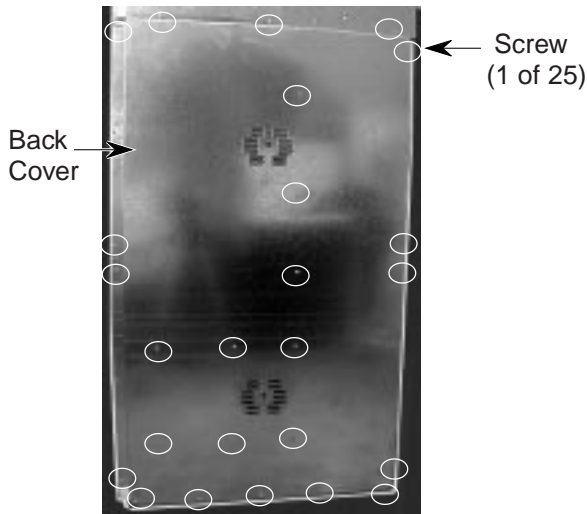

5. Remove the wire wraps from the vertical support holes and wrap them around the wire bundles at the same four locations. This will allow you to keep the ties around the same wires when you reinstall the support later.

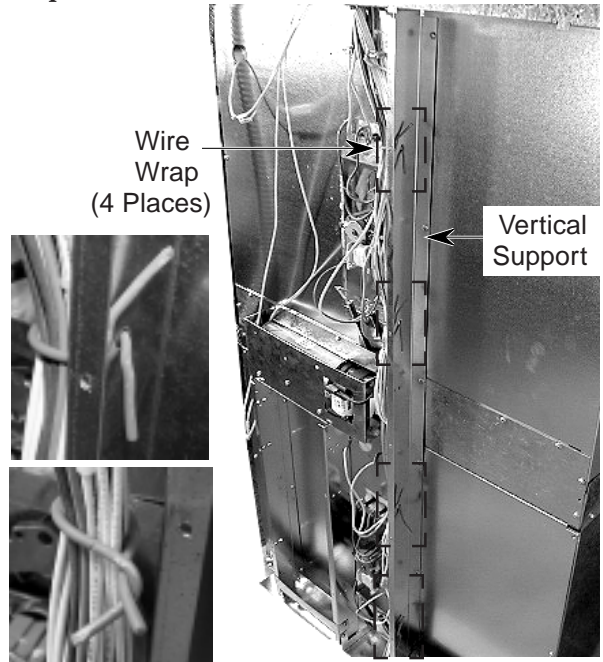

6. Remove the eight screws (circled) from the vertical support and remove the support from the back of the oven.

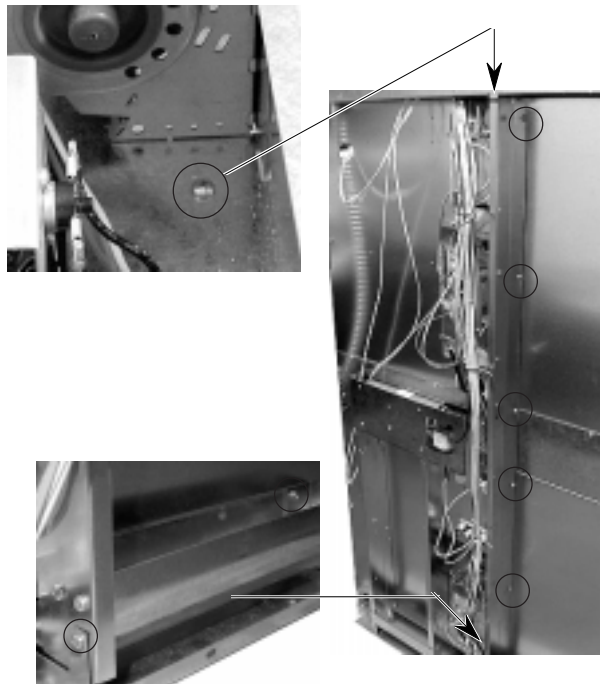



7. Remove the four bracket screws from the lower crossflow blower assembly and remove the assembly from the oven.
8. Disconnect the two motor wires (BU-74 & WH-75) and remove them from the wire wrap.

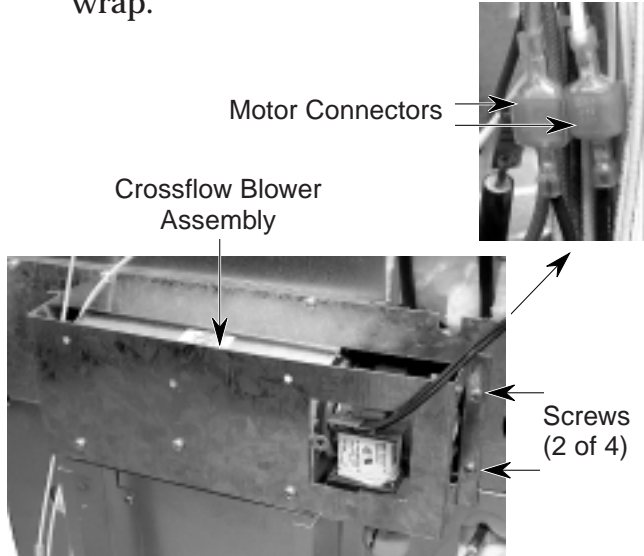

9. Remove the nine screws from the blower mounting plate.

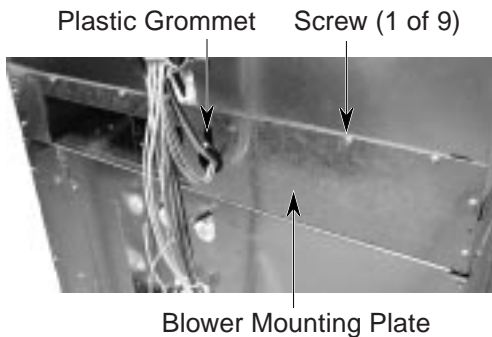

10. Remove the plastic grommet from the blower mounting plate hole and remove the grommet from the wiring.
11. Bend the blower mounting plate down 90° along the perforated edge.

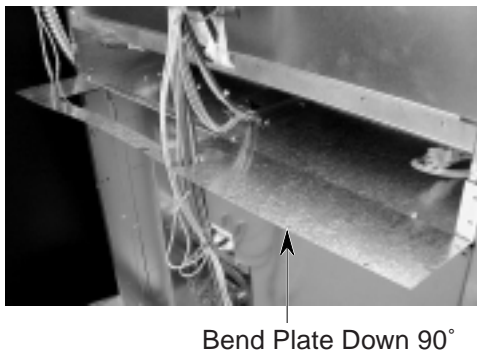

12. Bend the flange covering the hidden bake element down as necessary to remove the element.

Bend Flange Down To Access Bake Element



13. Disconnect the two orange wires (22 & 29) from the bake element terminals.
14. Remove the four screws from the mounting and element brackets (2 each).

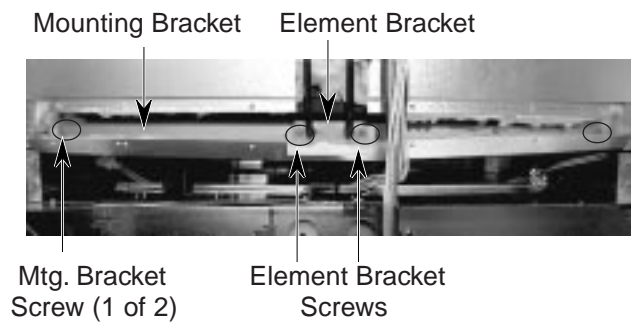

15. Position the wiring to the side and pull the bake element and mounting bracket out of the oven.

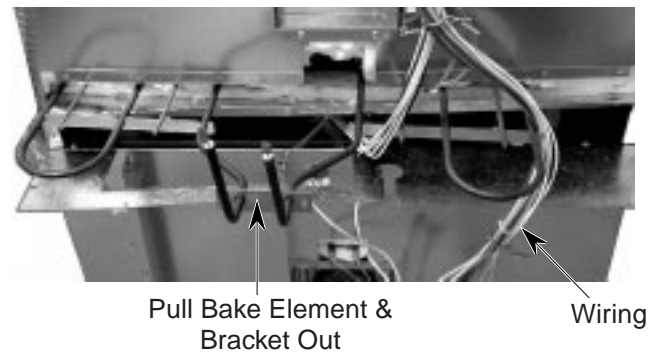

## REMOVING THE OVEN THERMAL SENSOR

### **⚠ WARNING**

Turn off the electrical power going to the oven before servicing.

### **⚠ CAUTION**

When you work on the oven, be careful when handling the sheet metal parts. There are sharp edges present and you can cut yourself if you are not careful.

1. Turn off the electrical power going to the oven.
2. Open the microwave oven door.
3. Remove the oven racks.
4. Remove the two screws from the oven thermal sensor.

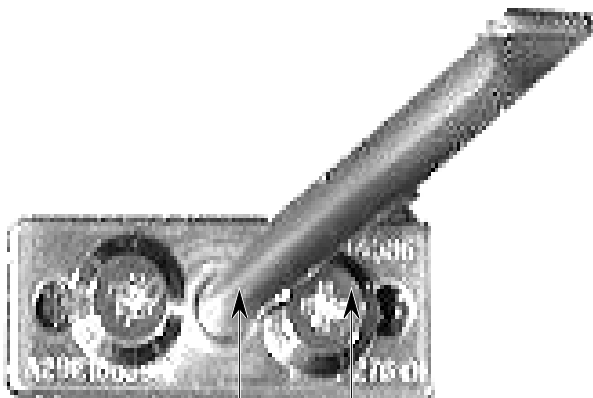

Thermal Sensor Screws

5. Pull the oven thermal sensor forward until the wire splices are inside the oven.

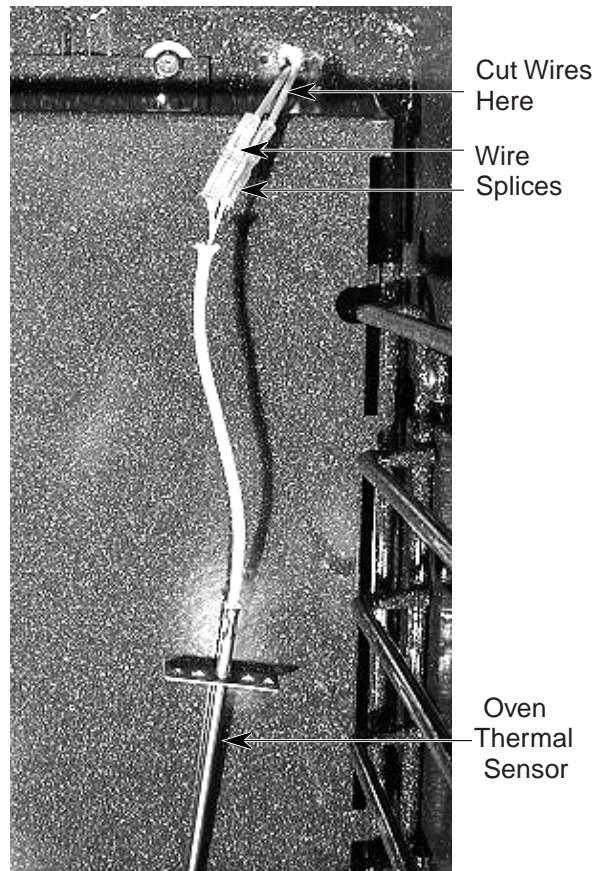

6. Using the instructions in the "Thermal Sensor Kit," (#35-00-306), splice the wires from the new oven thermal sensor to the main wires. Cut the wires from the old sensor at the location shown above.

## REMOVING THE UPPER (OR SINGLE) OVEN DOOR GASKET

1. Fully open the oven door.
2. Pull the ends of the oven door gasket out of the hole in the door liner.
3. Unclip the gasket from the door liner and remove it.

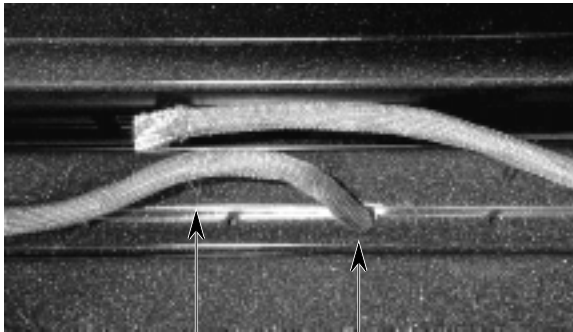

Pull Clips Out  
Of Holes In Liner

Pull Ends Out  
Of Hole In Liner



Upper (or Single)  
Oven Door Gasket

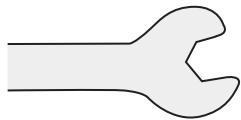

### Tech Tip!!

Use a small screwdriver to insert the ends of the gasket into the liner hole. Fully insert one end at a time



### Service Alert!!

Check around the door for microwave radiation leakage.

# REMOVING AND REINSTALLING THE MICROWAVE OVEN DOOR

## REMOVING THE OVEN DOOR

**CAUTION:** Be careful handling the oven door when removing it, as it is very heavy. Never lift the door by the handle.

1. Pull the oven out of its mounting location so that you can access the left and right hinge pocket covers (see the following photo).
2. Remove the screws from the left and right hinge pocket covers and remove the covers.

Hinge Pocket Cover



3. Remove the locking screw from each of the hinges.

Locking Screw

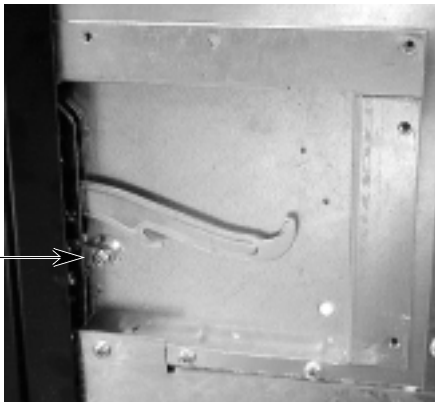

4. Fully open the oven door.



5. Raise the U-clip over the hook on each of the hinges to lock them. This will prevent the hinge from snapping closed when the door is removed.

Hook

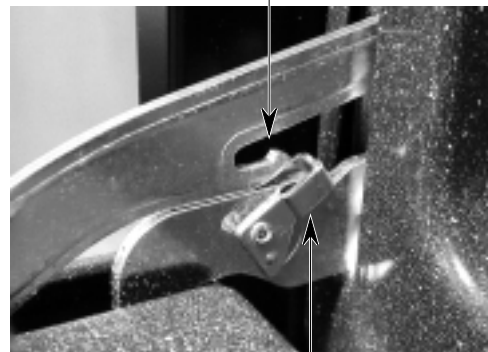

Raise U-Clip Over Hook

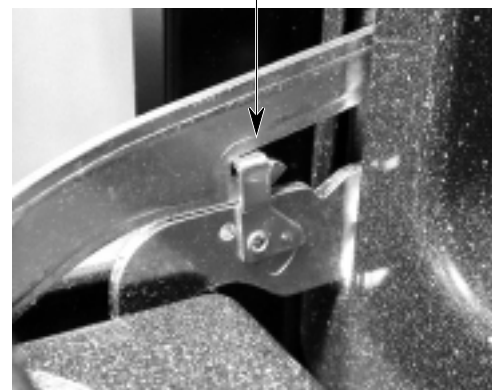

- Grasp the oven door by the sides near the top, and carefully close it until the hook in the hinge contacts the hinge support (approximately 3/4 of the way). You will feel some spring resistance while you do this, which is normal.



- Gently lean against the top of the door to hold it in position, and grasp the door firmly by the sides approximately 2/3 of the way down, then **open the door slightly**, and lift it until the hinges are free of the frame supports. Pull the hinges out of the oven slots and remove the door.



## REINSTALLING THE OVEN DOOR

- Hold the oven door by the sides approximately 2/3 of the way down and insert the hinges into the oven slots near the top as far as possible.



Insert Hinge Into  
Slot Near Top



**Continued on the next page.**

2. Lower the oven door to its fully open position.
3. Rotate the U-clips on the hinges forward to the unlocked position.



4. Close the oven door.
5. Reinstall the two hinge locking screws.

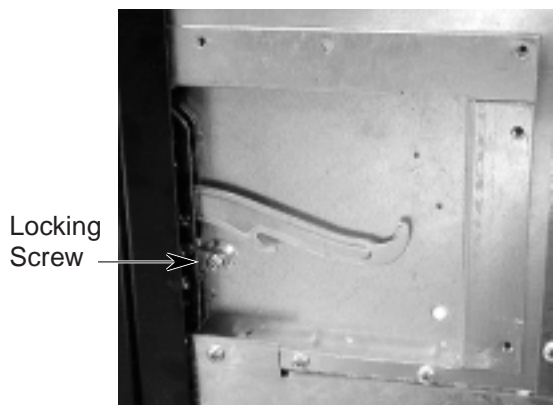

6. Reinstall the hinge pocket covers.

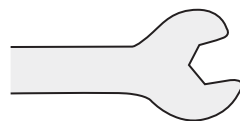

## Tech Tip!!

Make sure that the door seal is tight against the front of the oven liner and that the door is not crooked. If it is, push the hinges into the slots firmly until it is.



## Service Alert!!

After reinstalling the oven door, check around the door for microwave radiation leakage.

## REMOVING THE UPPER (OR SINGLE) OVEN DOOR HANDLE & OUTER GLASS ASSEMBLY

### **⚠ CAUTION**

When you work on the oven, be careful when handling the sheet metal parts. There are sharp edges present and you can cut yourself if you are not careful.

1. Remove the upper (or single) oven door from the unit (see Page 42) and lay it on a padded surface with the glass side down and the bottom edge facing you.
2. Remove the two bottom edge screws and the two top screws from the liner. This will separate the glass and liner sections of the door.

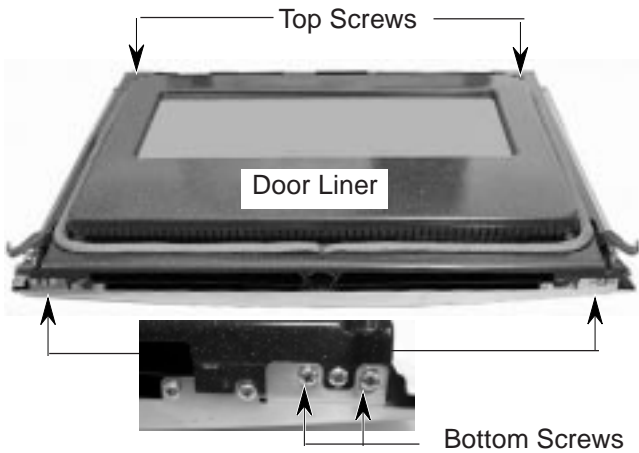

3. Lift the door liner assembly off the door glass assembly and set the liner aside.
4. **To remove the oven door handle**, remove the hex-head screws (see the small inset) from the left and right handle brackets and remove the brackets and handle from the glass.

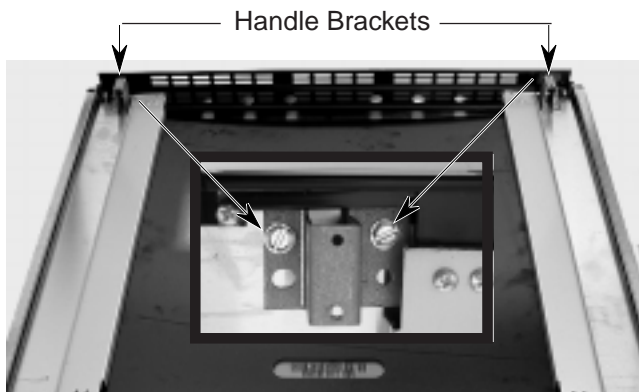

5. **To remove the outer oven door glass:**
  - a) Remove the four screws from the left and right glass support brackets and remove the brackets.

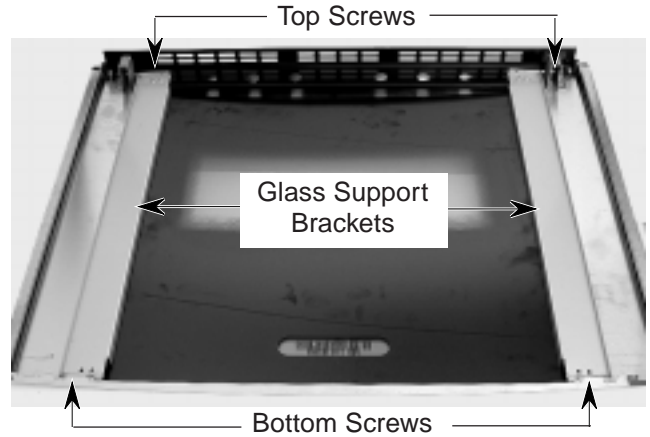

- b) Rotate the top door trim w/end caps back and remove it from the top of the door.

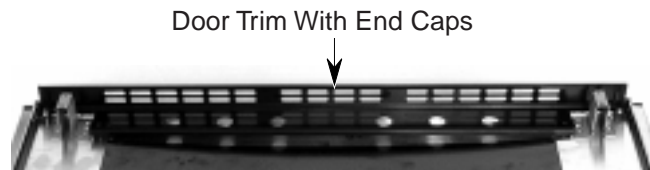

6. If not already done, remove the handle from the outer door glass (see Step 4).



### Service Alert!!

**After reinstalling the oven door, check around the door for microwave radiation leakage.**

# REMOVING AN OVEN DOOR HINGE, ACTUATOR ARM, CENTER GLASS, RF SCREEN, & INNER GLASS

## ⚠ CAUTION

When you work on the oven, be careful when handling the sheet metal parts. There are sharp edges present and you can cut yourself if you are not careful.

1. Remove the upper (or single) oven door from the unit (see Page 42) and lay it on a padded surface with the glass side down and the bottom edge facing you.
2. Remove the two bottom edge screws and the two top screws from the liner. This will separate the glass and liner sections of the door (see Page 47).
3. Lift the door liner assembly off the door glass assembly and lay it liner-side-down on the padded work surface. NOTE: Set the oven door glass assembly out of the way so it does not get damaged.
4. **To remove an oven door hinge:**
  - a) Remove the mounting screw at the bottom edge of the door.
  - b) Slide a piece of pipe over the end of the hinge and push it against the spring until you can unlock the U-clip, then allow the hinge to return to its unlocked position, and remove the pipe.
  - c) Unhook the hinge at the top, and remove the hinge.

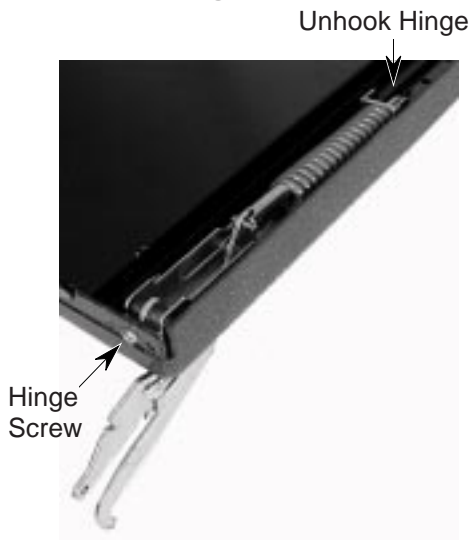

5. **To remove the actuator arm:**
  - a) Remove the four screws from the baffle and remove the baffle.
  - b) Remove the four screws from the actuator arm bracket and remove the actuator arm from the liner.

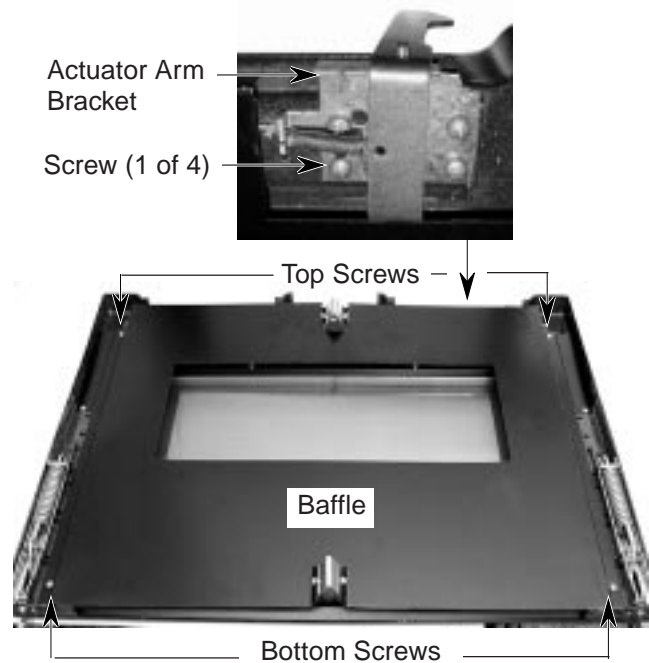

6. **To remove the center glass:**
  - a) Remove the four screws from the insulation cover and remove the cover.

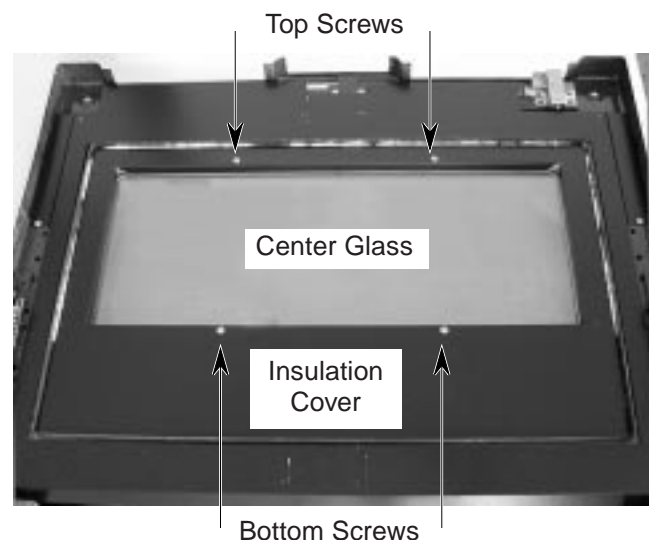



- b) Remove the insulation strip from around the center glass assembly.

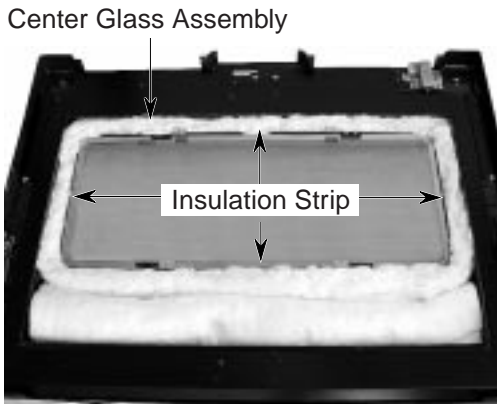

- c) Remove the screws from the four insulation cover brackets and the four glass assembly clamps and remove the brackets and clamps.

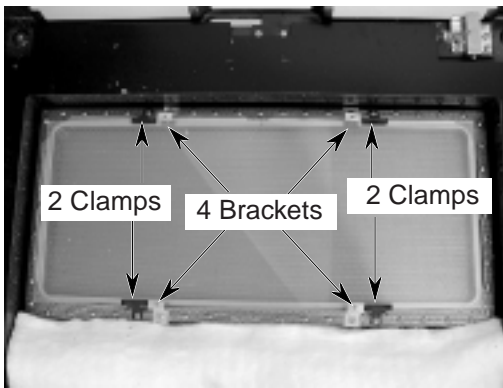

- d) Lift the center glass and frame out of the liner. **CAUTION:** The center glass is heat-treated on both sides. If you remove both the center and inner glass, **be sure to install the heat-treated glass in the center glass position.**

- 7. **To remove the RF screen and the inner glass:**

- a) Remove the bottom insulation from the door.
- b) Remove the forty-eight screws from the screen and remove the screen from over the inner glass. **REASSEMBLY NOTE:** Make sure that you position the screen with the best side showing through the inner glass.

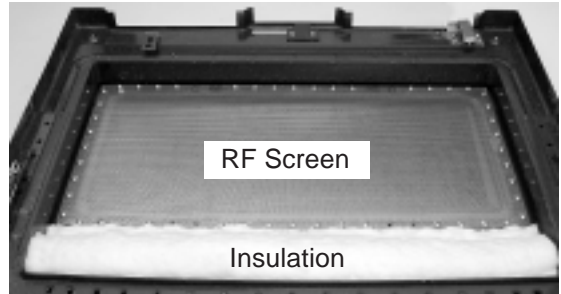

- c) Lift the inner glass off the oven door. **CAUTION:** The inner glass is not heat-treated like the center glass. **Be sure to install the untreated glass in the inner glass position.**

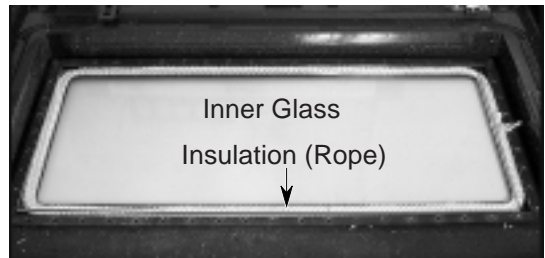

- d) If you need to replace the insulation "rope" that is under the inner glass, pull it out of the track and install the new one in its place. **REASSEMBLY NOTE:** Make sure that the end strands of the insulation do not show through the inner glass when you reinstall the glass.

**Continued on the next page.**



## Service Alert!!

After reinstalling the oven door, check around the door for microwave radiation leakage.

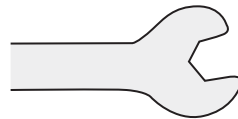

## Tech Tip!!

The center glass is heat-treated and has the letters "HB" stamped in two places near one of the edges.

If you are in doubt as to which glass is heat-treated, use an ohmmeter to check it. To do this, set the ohmmeter to the R X 1 scale and touch the test probes to the glass. If the glass is heat-treated, the meter will indicate a short ( $0 \Omega$ ). If the meter does not indicate a reading (infinity), the glass is untreated.

# TROUBLESHOOTING

## TESTING THE COMPONENTS

### Resistance Measurements

## **⚠ WARNING**

**TO AVOID ELECTRICAL SHOCK DISCONNECT THE POWER TO THE APPLIANCE BEFORE TESTING.**

### 20A TIME-DELAY FUSE

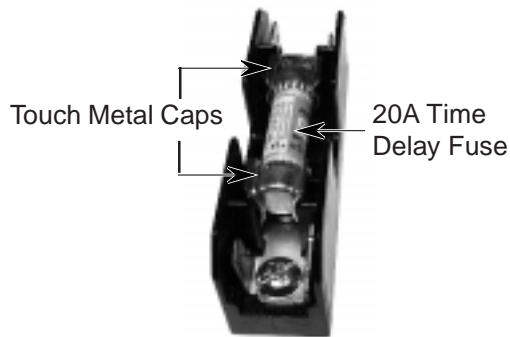

Refer to Page 12 to access the 20A time-delay fuse. To test the 20A time-delay fuse, perform the following steps.

1. Turn off the electrical power to the oven.
2. Set the ohmmeter to the R x 1 scale.
3. Touch the test leads to the metal end caps of the fuse. If the fuse is good, the meter should indicate a short circuit (0  $\Omega$ ). If the fuse is open, the meter will indicate an open circuit (infinite resistance).

### TRANSFORMER COOLING FAN MOTOR

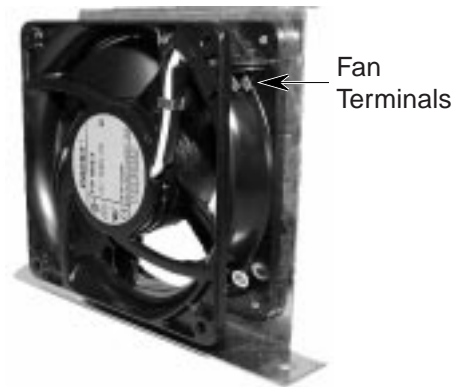

Refer to Page 15 to access the transformer cooling fan. To test the motor, perform the following steps.

1. Turn off the electrical power to the oven.
2. Disconnect one of the wires from the fan motor.
3. Set the ohmmeter to the R x 1 scale.
4. Touch the test leads to the motor terminals. The meter should indicate between 135  $\Omega$  and 150  $\Omega$ .

## LIGHT TRANSFORMER

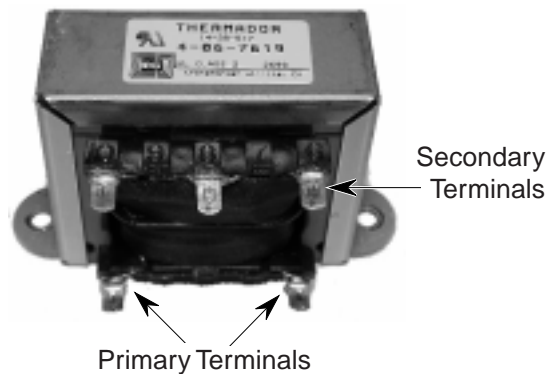

Refer to Page 13 to access the light transformer. To test the light transformer, perform the following steps.

1. Turn off the electrical power to the oven.
2. Set the ohmmeter to the R x 1 scale.
3. Disconnect one of the wires from the bottom (primary) terminals.
4. Touch the test leads to the bottom terminals. The meter should indicate less than 1  $\Omega$ .
5. Disconnect the wires from the top three terminals.
6. Touch the test leads to the following numbered terminals. The meter should indicate less than 1  $\Omega$  at each location:
  - a) Terminals 8 and 6
  - b) Terminals 8 & 10.
  - c) Terminals 6 and 10.

## DOUBLE LINE BREAK RELAY

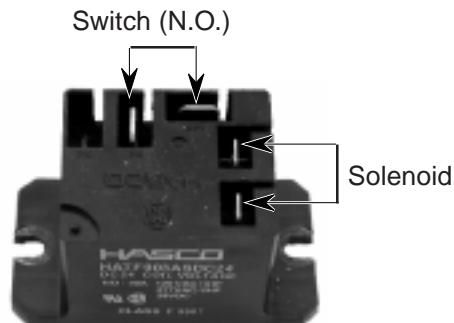

Refer to Page 13 to access the double line break relay. To test the double line break relay, perform the following steps.

1. Turn off the electrical power to the oven.
2. Set the ohmmeter to the R x 1 scale.
3. Disconnect the two yellow (solenoid) wires from the relay.
4. Touch the test leads to the relay terminals. The meter should indicate less than 1  $\Omega$ .
5. Disconnect the other two (switch) wires from the relay.
6. Touch the test leads to the relay terminals. The meter should indicate an open circuit (infinite resistance).

## STIRRER MOTOR

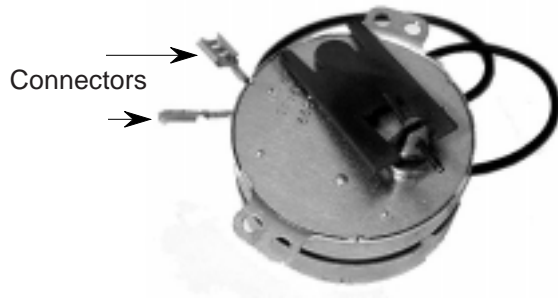

Refer to Page 14 to access the stirrer motor. To test the stirrer motor, perform the following steps.

1. Turn off the electrical power to the oven.
2. Set the ohmmeter to the R x 1 scale.
3. Disconnect the stirrer motor wire going to the terminal block.
4. Touch the test leads to the motor connectors. The meter should indicate approximately 1.5  $\Omega$ .

## HIGH VOLTAGE DIODE

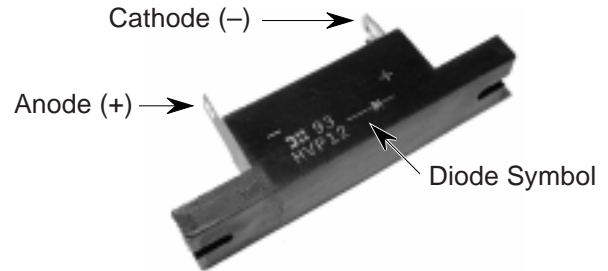

**CAUTION: DISCHARGE THE HIGH VOLTAGE CAPACITOR BEFORE TESTING THE DIODE. REFER TO PAGE 18 FOR THE PROCEDURE.**

Refer to Page 19 to access the high voltage diode. To test the high voltage diode, perform the following steps.

1. Turn off the electrical power to the oven.
2. Set the ohmmeter to the R x 1 scale.
3. Disconnect the wires from the diode.

**IMPORTANT:** Use the above photo for the proper terminal polarity connections. Disregard any other polarity markings on the diode body.

4. Touch the negative (-) meter lead to the cathode terminal and the positive (+) lead to the anode terminal. The meter should indicate continuity (current flow).
5. Switch the test leads and the meter should indicate a very high resistance.

## HIGH VOLTAGE CAPACITOR



**CAUTION: DISCHARGE THE HIGH VOLTAGE CAPACITOR BEFORE TESTING IT. REFER TO PAGE 18 FOR THE PROCEDURE.**

Refer to Page 18 to access the high voltage capacitor. To test the high voltage capacitor, perform the following steps.

1. Turn off the electrical power to the oven.
2. Set the ohmmeter to the R x 10K scale.
3. Disconnect the wires from the capacitor terminals.
4. Touch the test leads to the capacitor terminals. The meter should indicate a high resistance, and then gradually begin to fall back toward infinity.
5. Switch the test leads and the meter should again indicate a high resistance, and gradually fall back toward infinity.

## HIGH VOLTAGE TRANSFORMER

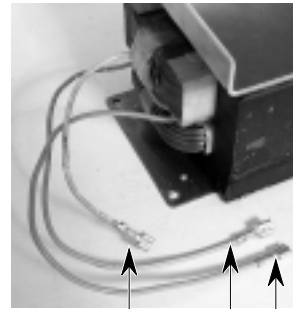

Tan Lead  
(secondary)      Orange Leads  
(secondary)

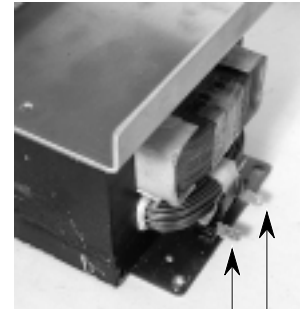

Primary  
Terminals

**CAUTION: DISCHARGE THE HIGH VOLTAGE CAPACITOR BEFORE TESTING THE TRANSFORMER. REFER TO PAGE 18 FOR THE PROCEDURE.**

Refer to Page 19 to access the high voltage transformer. To test the high voltage transformer, perform the following steps.

1. Turn off the electrical power to the oven.
2. Set the ohmmeter to the R x 1 scale.

### Testing The Primary Winding

3. Disconnect the black and white wires from the primary terminals of the transformer.
4. Touch the test leads to the primary terminals. The meter should indicate less than 1  $\Omega$ .

### Testing The Secondary Windings

5. Disconnect the two orange transformer wires from the magnetron terminals.
6. Touch the test leads to the orange wire connectors. The meter should indicate less than 1  $\Omega$ .
7. Disconnect the light tan transformer wire from the high voltage capacitor.
8. Touch one of the test leads to the chassis and the other lead to the tan wire connector. The meter should indicate less than 1  $\Omega$ .

## MAGNETRON

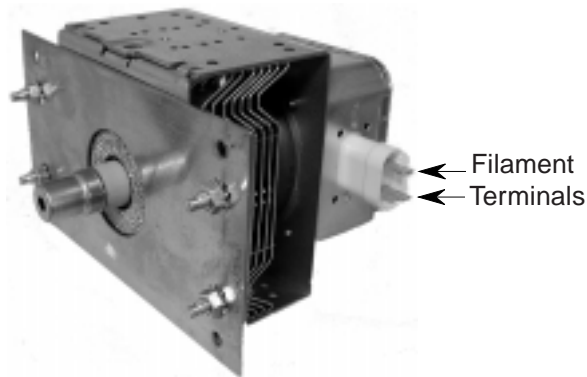

**CAUTION: DISCHARGE THE HIGH VOLTAGE CAPACITOR BEFORE TESTING THE MAGNETRON. REFER TO PAGE 18 FOR THE PROCEDURE.**

Refer to Page 22 to access the magnetron. To test the magnetron, perform the following steps.

1. Turn off the electrical power to the oven.
2. Set the ohmmeter to the R x 1 scale.
3. Disconnect the leads from the filament terminals of the magnetron.
4. Touch the test leads to the primary terminals. The meter should indicate less than 1  $\Omega$ .

## MAGNETRON THERMAL CUTOUT (TCO)

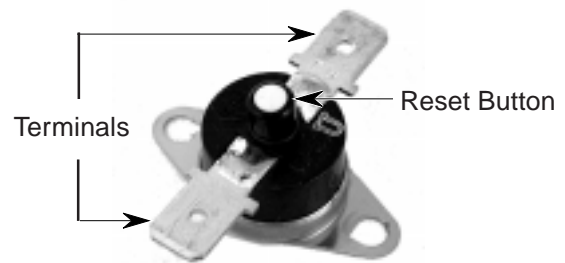

**CAUTION: DISCHARGE THE HIGH VOLTAGE CAPACITOR BEFORE TESTING THE MAGNETRON THERMAL CUTOUT. REFER TO PAGE 18 FOR THE PROCEDURE.**

Refer to Page 27 to access the magnetron thermal cutout (TCO). To test the TCO, perform the following steps.

1. Turn off the electrical power to the oven.
2. Set the ohmmeter to the R x 1 scale.
3. Disconnect one of the leads from the magnetron TCO terminals.
4. Touch the test leads to the normally-closed terminals. The meter should indicate a short circuit (0  $\Omega$ ). NOTE: If the meter indicates an open circuit, (infinite resistance), press the reset button on the TCO and check it again. If it remains open, replace the TCO.

## MAGNETRON FAN MOTOR

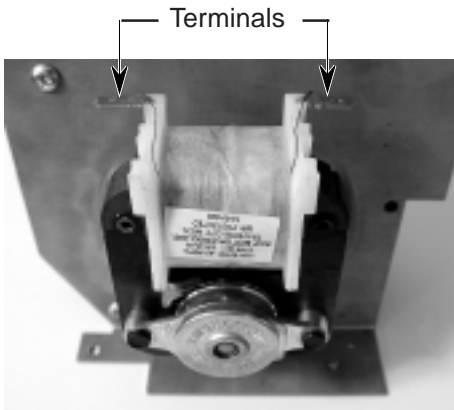

Refer to Page 16 to access the magnetron fan motor. To test the motor, perform the following steps.

1. Turn off the electrical power to the oven.
2. Set the ohmmeter to the R x 1 scale.
3. Disconnect one of the leads from the magnetron fan motor terminals.
4. Touch the test leads to the motor terminals. The meter should indicate less than 1  $\Omega$ .

## CROSSFLOW BLOWER MOTOR

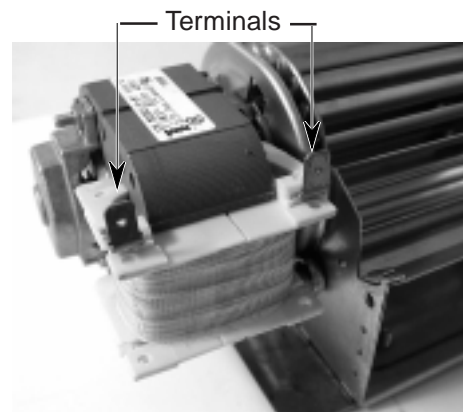

Refer to Page 17 to access the crossflow blower. To test the motor, perform the following steps.

1. Turn off the electrical power to the oven.
2. Set the ohmmeter to the R x 1 scale.
3. Disconnect one of the leads from the crossflow blower motor terminals.
4. Touch the test leads to the motor terminals. The meter should indicate less than 1  $\Omega$ .



## DOOR LATCH ASSEMBLY

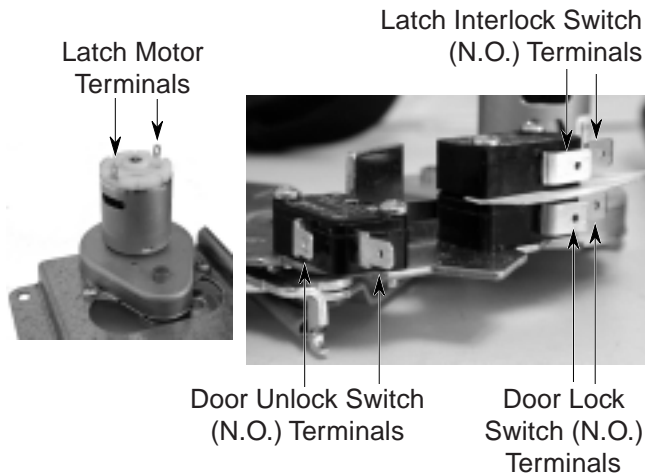

Refer to Page 26 to access the door latch assembly. To test the door latch assembly components, perform the following steps.

1. Turn off the electrical power to the oven.
2. Set the ohmmeter to the R x 1 scale.

### Testing The Latch Motor

3. Disconnect the two orange wires from the latch motor terminals.
4. Touch the test leads to the motor terminals. The meter should indicate less than 1  $\Omega$ .

### Testing The Door Lock, Door Unlock, & Latch Interlock Switches (All Normally-Open N.O.)

5. Disconnect one of the wires from the terminal of the switch under test.
6. Touch the test leads to the switch terminals. The meter should indicate an open circuit (infinite resistance).
7. Press the switch button to close the contacts. The meter should indicate a short circuit (0  $\Omega$ ).

## MONITOR & SECONDARY SWITCHES

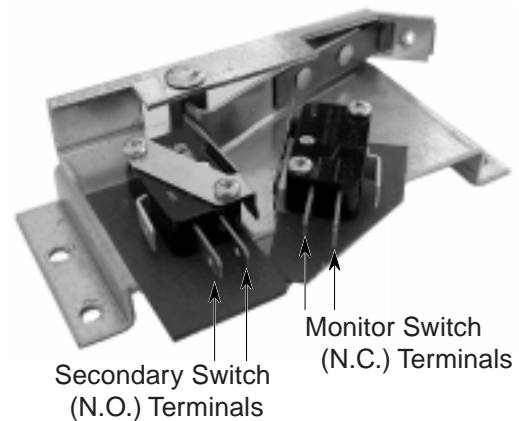

Refer to Page 27 to access the monitor and secondary switches. To test the switches, perform the following steps.

1. Turn off the electrical power to the oven.
2. Set the ohmmeter to the R x 1 scale.

### Testing The Secondary Switch (Normally-Open N.O.)

3. Disconnect one of the wires from the secondary switch.
4. Touch the test leads to the switch terminals. The meter should indicate an open circuit (infinite resistance).
5. Press the switch button to close the contacts. The meter should indicate a short circuit (0  $\Omega$ ).

### Testing The Monitor Switch (Normally-Closed N.C.)

6. Disconnect one of the wires from the monitor switch.
7. Touch the test leads to the switch terminals. The meter should indicate a short circuit (0  $\Omega$ ).
8. Press the switch button to close the contacts. The meter should indicate an open circuit (infinite resistance).

## DOOR SWITCH

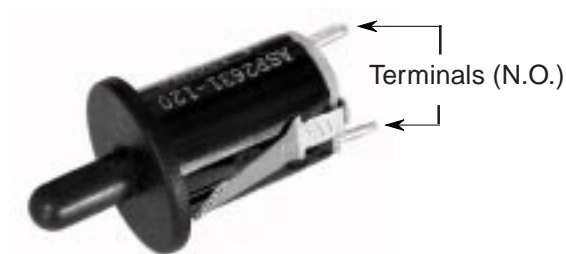

Refer to Page 25 to access the door switch. To test the switch, perform the following steps.

1. Turn off the electrical power to the oven.
2. Set the ohmmeter to the R x 1 scale.
3. Disconnect one of the wires from the door switch.
4. Touch the test leads to the normally-open switch terminals. The meter should indicate an open circuit (infinite resistance).
5. Press the switch button to close the contacts. The meter should indicate a short circuit (0  $\Omega$ ).

## OVEN THERMAL SENSOR



Refer to Page 40 to access the oven thermal sensor. To test the sensor, perform the following steps.

1. Turn off the electrical power to the oven.
2. Set the ohmmeter to the R x 1 scale.
3. Touch the test leads to the in-line splice connections inside the oven with the sensor removed, or at connector P3 on the electronic oven control board. The meter should indicate approximately 1050  $\Omega$  at room temperature.

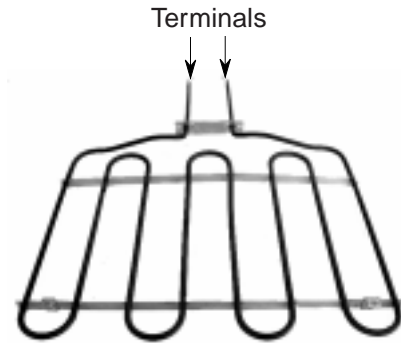
**BROIL ELEMENT**

Refer to Page 30 to access the broil element. To test the element, perform the following steps.

1. Turn off the electrical power to the oven.
2. Set the ohmmeter to the R x 1 scale.
3. Disconnect one of the wires from the broil element.
4. Touch the test leads to the broil element terminals. The meter should indicate between 13  $\Omega$  and 20  $\Omega$ .

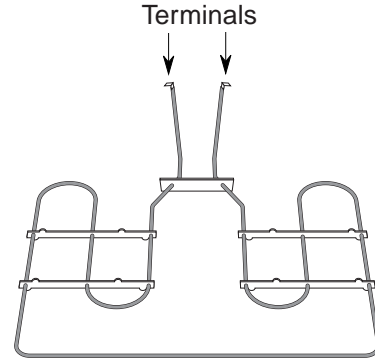
**BAKE ELEMENT**

Refer to Page 38 to access the bake element. To test the element, perform the following steps.

1. Turn off the electrical power to the oven.
2. Set the ohmmeter to the R x 1 scale.
3. Disconnect one of the wires from the bake element.
4. Touch the test leads to the bake element terminals. The meter should indicate between 20  $\Omega$  and 30  $\Omega$ .

## CONVECTION ELEMENT

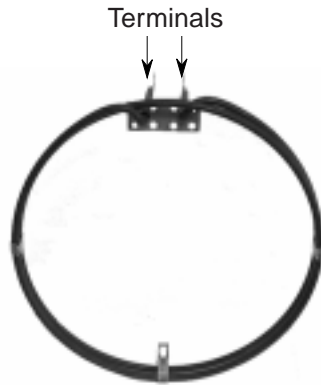

Refer to Page 34 to access the convection element. To test the element, perform the following steps.

1. Turn off the electrical power to the oven.
2. Set the ohmmeter to the R x 1 scale.
3. Disconnect one of the wires from the convection element.
4. Touch the test leads to the convection element terminals. The meter should indicate between 15  $\Omega$  and 25  $\Omega$ .

## CONVECTION MOTOR

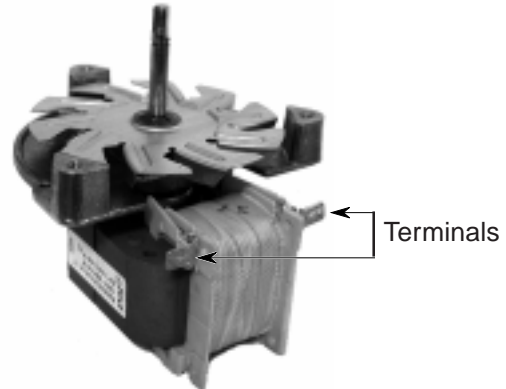

Refer to Page 36 to access the convection motor. To test the motor, perform the following steps.

1. Turn off the electrical power to the oven.
2. Set the ohmmeter to the R x 1 scale.
3. Disconnect one of the wires from the convection motor.
4. Touch the test leads to the convection motor terminals. The meter should indicate between 10  $\Omega$  and 20  $\Omega$ .

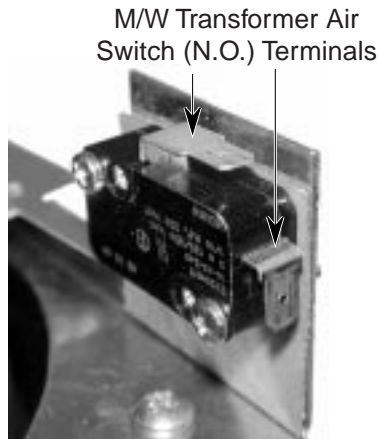
**M/W TRANSFORMER AIR SWITCH**

Refer to Page 15 to access the M/W transformer air switch. To test the switch, perform the following steps.

1. Turn off the electrical power to the oven.
2. Disconnect one of the wires from the M/W transformer air switch.
3. Set the ohmmeter to the R x 1 scale.
4. Touch the test leads to the switch terminals. The meter should indicate an open circuit (infinite resistance).
5. Actuate the M/W transformer air switch by moving the air paddle. The meter should indicate a short circuit ( $0 \Omega$ ).

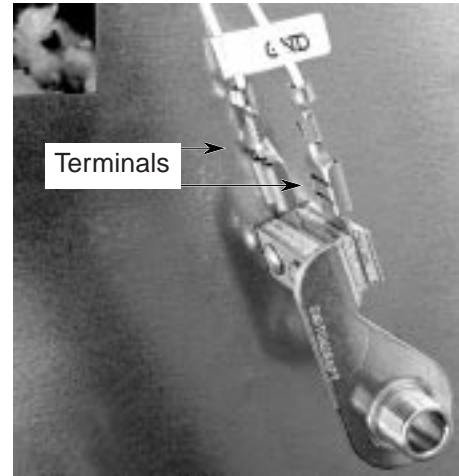
**MEAT PROBE JACK**

Refer to Page 37 to access the meat probe jack. To test the jack, perform the following steps.

1. Set the ohmmeter to the R x 1 scale.
2. Disconnect one of the wires from the meat probe jack.
3. Touch the test leads to the meat probe jack terminals. The meter should indicate an open circuit (infinite resistance).
4. Plug the meat probe into the jack. The meter should indicate a short circuit ( $0 \Omega$ ).

## MICROWAVE PCB CONTROL

Refer to Page 12 to access the microwave PCB control. The control has a relay (K1), two headers (P1 & P3), and two 1/4" wire terminals (P2-1 & P2-2). These components perform the following functions:

**Relay K1:** Transfers 120-volts AC to the high-voltage transformer to activate the microwave circuitry. K1 is activated by 24-volts DC from the relay board.

**Header P1:** Receives 24-volts and 5-volts DC from the relay board using wire harness connector P6. The 18-volts DC activates the relay coil, and the 6-volts DC activates the triac on the Microwave PCB Control.

**Terminal P2-1:** Inputs 120-volts AC from the latch interlock switches.

**Terminal P2-2:** Outputs 120-volts AC to the high-voltage transformer when relay K1 closes.

**Header P3:** Receives 12-volts AC from the halogen light transformer at pins 1 & 2, and Pins 3 & 4 output 12-volts DC to activate the upper (or single) oven latch motor. The 12-volts DC is produced by passing the 12-volts AC through a bridge rectifier (see the following circuits).

### Positive AC Cycle

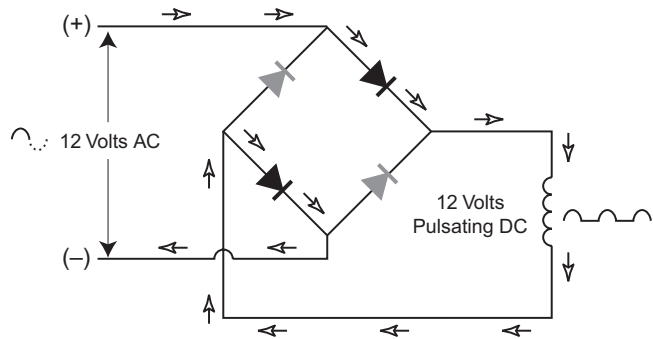

### Negative AC Cycle

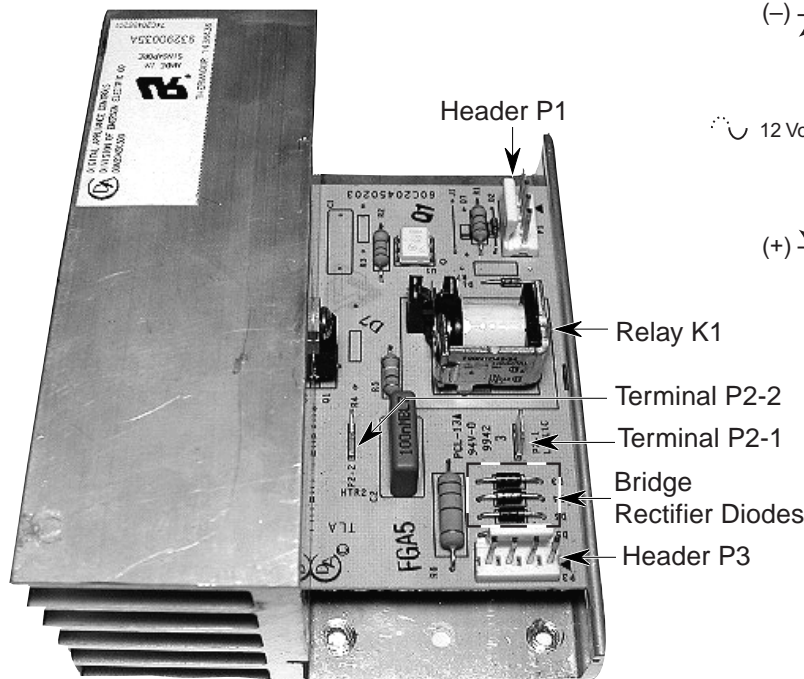
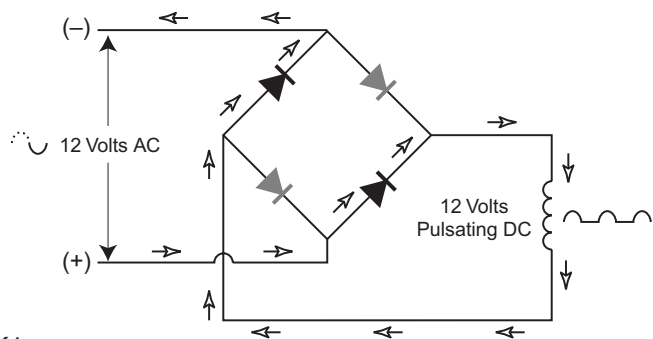

# MICROWAVE COMPONENTS DESCRIPTION

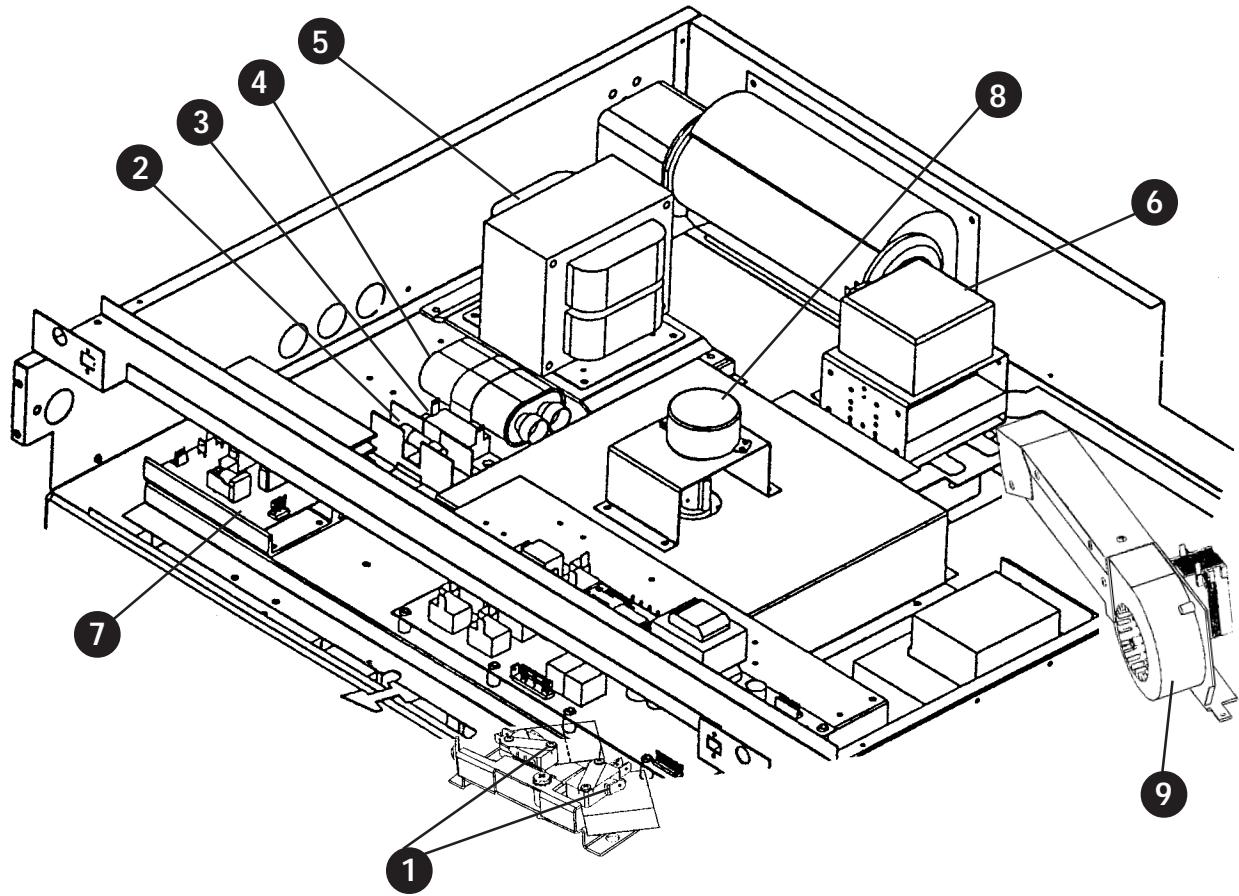

- 1 Switches
- 2 Fuse
- 3 Diode (High Voltage)
- 4 Capacitor (High Voltage)
- 5 Transformer (High Voltage)
- 6 Magnetron Tube
- 7 Microwave PCB Control
- 8 Stirrer Motor
- 9 Microwave Cooling Fan

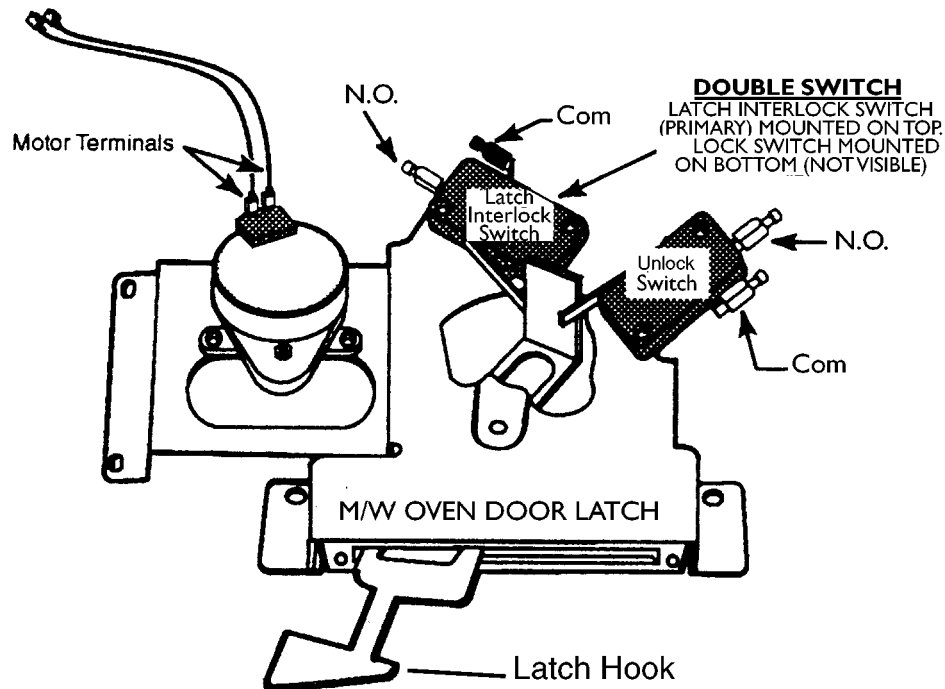

## The interlock switches

The CM Oven has a total of 3 safety switches. The primary switch is mounted on the upper oven latch (latch interlock switch). The other two switches are mounted in the upper plenum behind and below the control panel. These switches are the monitor and secondary switch. These switches are designed to prevent the microwave oven from operating if the door does not close properly or the primary switches fails. These switches are not adjustable. They must be replaced if they fail.

### Latch mounted switch;

The primary latch interlock switch is mounted on the microwave oven door latch assembly. When microwave is selected, the latch assembly motor latches the door closed. The latch lock switch which is "normally open" closes to signal the relay board that the door is latched. The latch interlock switch which is also normally open closes and completes the circuit to the microwave board.

\*The latch hook will not close the switches unless the microwave oven door is closed when the motorized latch is operated.



## Oven Mounted Switches

The secondary and the monitor switches are mounted on a bracket. The bracket is located on the plenum behind the control panel on the right side of the oven (see Front View, below).

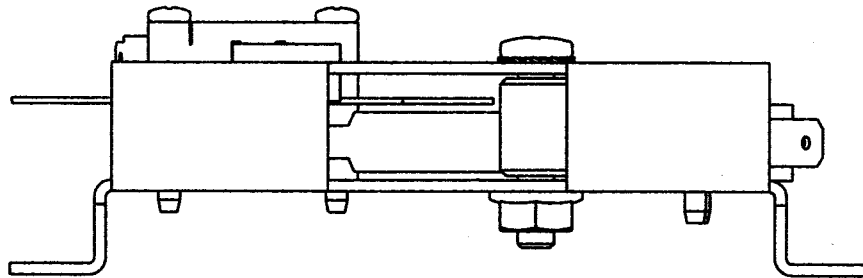

Front View

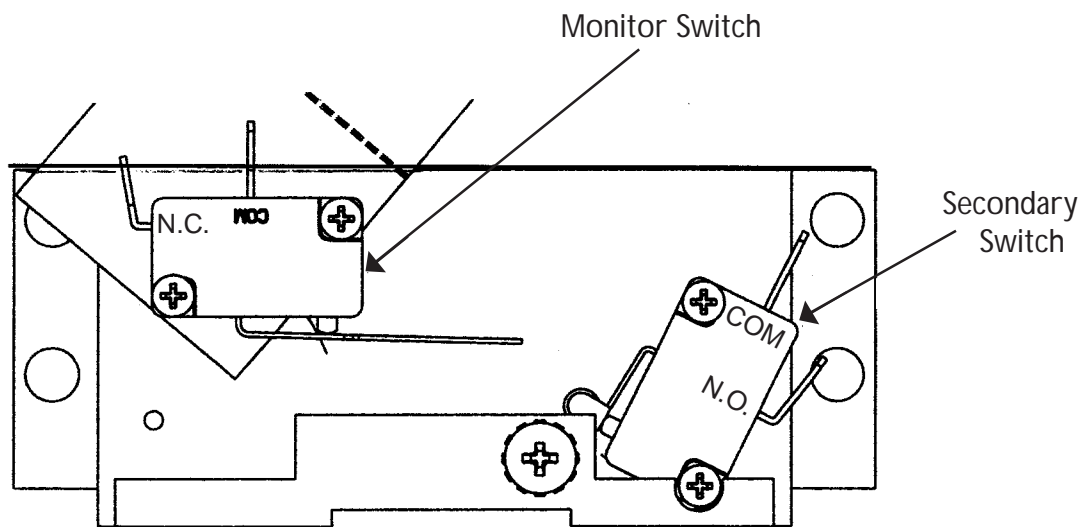

Top View

The monitor switch is mounted on the left side of the bracket. It is normally closed. The switch is opened by the forward motion of the hook (See Figure A) when the door is closed. The purpose of this switch is to cause the fuse to blow if the latch switch is not open when the microwave door is opened. The switch is wired across the neutral and positive side of the line. The fuse will blow if the monitor switch and the primary switch are closed at the same time.

The right side door interlock switch (secondary) is mounted on the right side of the oven bracket. It is normally open. The switch is closed by side ways motion of the hook (See Figure A) when the oven door is closed. This switch provides a current path to the microwave plate transformer. With the door open or if the switch fails, there is no current to the microwave transformer. The oven mounted switches are mounted as shown in the illustration above, facing the oven (See Top View, above)

## Switches Activated by Hook

The switches are activated by a spring action hook on the microwave oven door. When the door is closed, the hook contacts and activates the switches (see illustration, below).

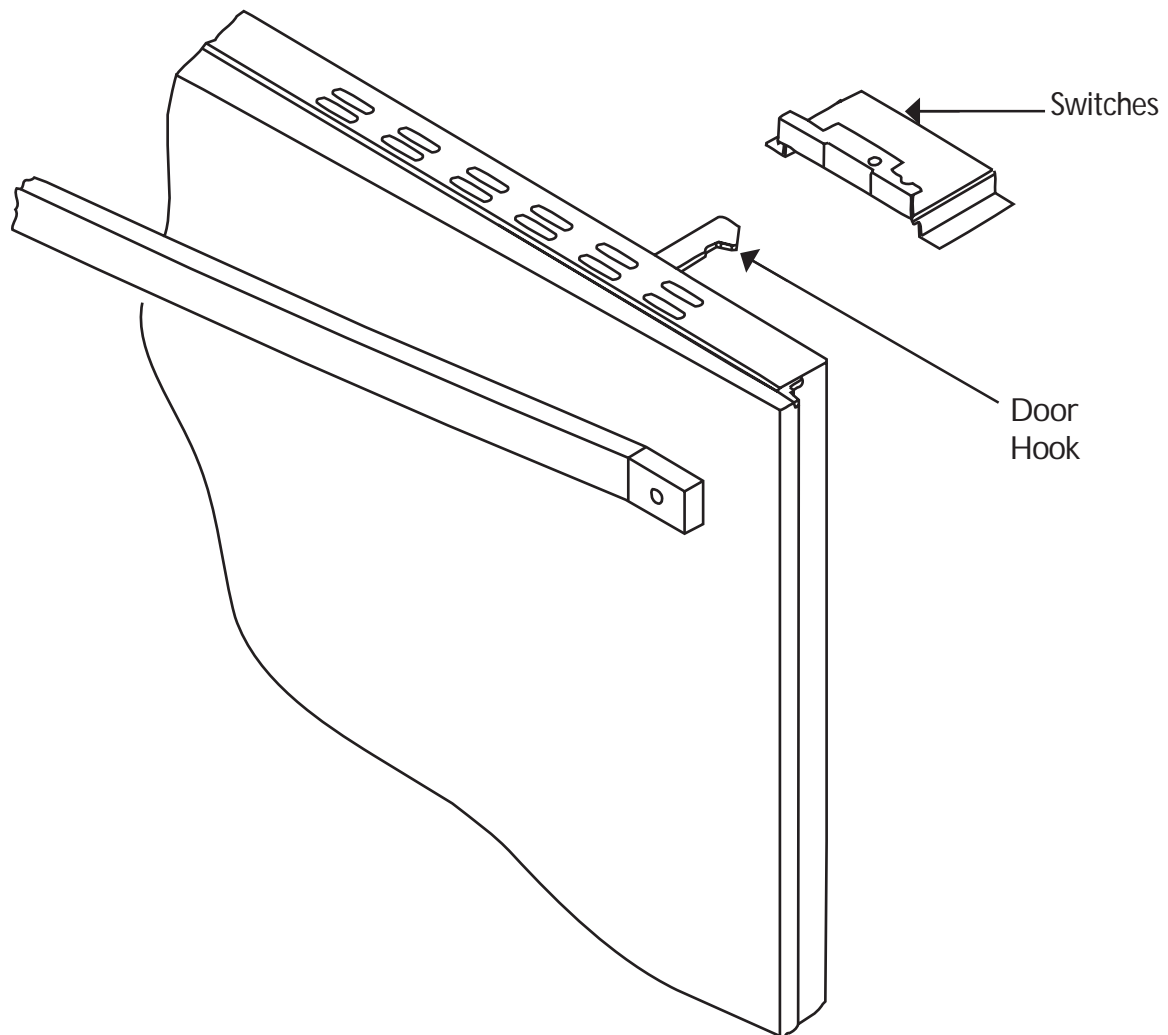

**20 AMPERE FUSE**

The Microwave Oven is protected from interlock switch failure by a 20 ampere Fuse. A defective switch or any other factor causing an overload on the microwave circuit will blow the fuse and stop the operation of the microwave section of the oven. The fuse is located in a fuse holder in the upper plenum.

### **Microwave Fuse Failure:**

The purpose of the fuse system is to prevent operation of the unit in the event of a safety switch failure. The safety switches prevent the unit from emitting microwave energy if the door is not completely closed. The following is an explanation of the safety switches and an explanation of the fuse protection system. The safety switches are the monitor switch and the latch interlock switch (primary switch), and the right side door interlock switch (secondary switch).

The latch interlock switch (primary switch) is mounted on the latch assembly. The latch interlock switch is closed by the latching of the motorized oven door latch.

The monitor switch and the right side door interlock switch (secondary switch) are activated by the door strike movement.

### **Fuse Failure Modes:**

The fuse can open due to any of the following failure modes:

- 1) A short in the microwave circuit or a component failure that causes the microwave circuit to draw more than 20 amps.
- 2) The monitor switch is closed when the latch's interlock switch is also closed.

**DO NOT ATTEMPT TO REPAIR A SAFETY SWITCH.  
REPLACE A FAILED SAFETY SWITCH.**

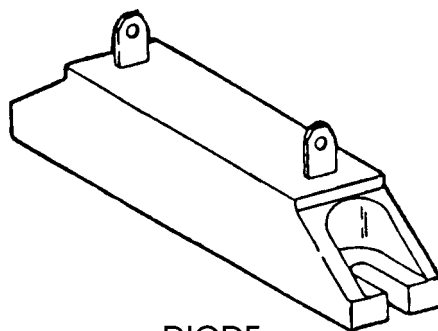

DIODE

## DIODE

The diode is a device used to convert alternating current (AC) into pulsating direct current (DC) allowing it to pass forward in one direction while blocking the current flow in the opposite direction. There is no charge stored in this part.

## HIGH VOLTAGE TRANSFORMER

The high voltage transformer has one primary winding and two secondary windings. The “stepup” secondary winding converts 120 volts AC. To 2300 volts across the transformer terminals.

The other secondary winding “steps down” 120 volts AC to 3.3 volts AC. Which heats the magnetron tubes cathode filament. The cathode filament preheats approximately 1 second before the high voltage circuit is energized.

## MAGNETRON TUBE

The magnetron tube is a vacuum tube in which the flow of electrons from the heated cathode to the anode is controlled by a magnetic field to produce an electromagnetic wave (2450 mhz). These electromagnetic waves are called “microwaves.”

To operate the magnetron tube requires both a minimum power input of 3800 to 4000 volts DC. From the transformer. Diode, and capacitor, and 3.8 volts from the filament transformer lead. The tube has a 650 watt rating.

### Note

Wire mesh gasket (rf) between the magnetron tube and the wave guide must be in place when reinstalling the tube. When reinstalling the tube, tighten the four tube nuts diagonally. Do not tighten the two nuts on one side, then the two nuts on the other side. (Removing and replacing the magnetron tube requires a microwave leakage test.)

## MICROWAVE BOARD

The Microwave Board has one snap relay (K1).; Two Pin Headers (P1 and P3) and two 1/4" terminals (P2-1 and P2-2).

### K1 Relay:

This relay transfers 120 Volts AC to the high voltage transformer to activate the microwave circuit. The K1 Relay Coil is activated by 24 Volts DC from the relay board.

### P1 Pin Header

This is a 3-pin header that receives 24 Volt DC from the Relay Board using a wire harness from PIN Header P6 on the relay board.

### P3 Pin Header

Pins 1 and 2 inputs 12 Volts AC from the halogen light transformer circuit. Pins 3 and 4 output 12 volts DC (Rectified through a series of diodes) to activate the upper oven (or single oven) latch motor.

### P2-1 Terminal:

This terminal inputs 120 Volts AC from the latch interlock switches.

### P2-2 Terminal:

This terminal outputs 120 Volts AC to the transformer when relay K1 closes.

## STIRRER MOTOR

The stirrer motor is a 120 volt AC motor. The purpose of the stirrer motor is to run the stirrer blades at the output of the wave guide. The stirrer rotates at about 60 rpm.

As the microwave energy enters the oven cavity through the wave guide, it bounces off the rotating stirrer blades and is reflected throughout the oven cavity at constantly changing angles, providing a more even microwave distribution.

In the jet impinged oven, the stirrer blade also mixes the air flow into the top of the oven.

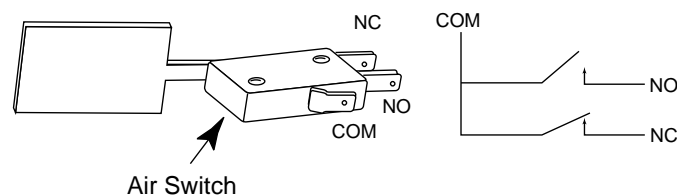

## Microwave Transformer Cooling Fan and Air Switch

The Microwave Transformer Cooling Fan is a box fan mounted between the control panel and the high voltage transformer. There is an air switch (see illustration, above) with a paddle mounted on the fan bracket. The fan blows air across the high voltage transformer to keep the transformer cool. The air flow from the fan moves the paddle on the air switch. The paddle movement closes the normally open contacts on the air switch. The air switch is in series with the air switch located on the base area below the lower oven. If this air switch does not close, you will see an F34 error code in the control panel.

# “CM” Lower Oven

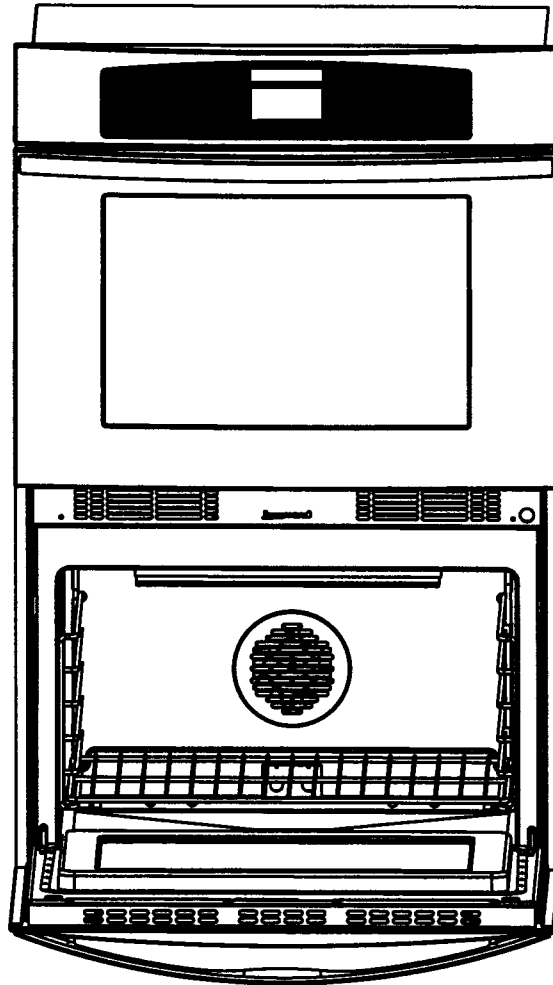

**“CM” RELAY BOARD MATRIX**

<b>REPLAY</b>	<b>FUNCTION</b>
K0	Upper Oven Latch Motor
K1	Lower Oven Latch Motor
K2	None
K3	None
K4	Upper Oven Cooling Motor
K5	Lower Oven Cooling Motor
K6	Upper Oven Halogen Lamp
K7	Lower Oven Halogen Lamp
K8	Upper Oven Bake Element
K9	Upper Oven Broil Element
K10	Upper Oven Convection Element
K11	Upper Oven Convection Motor
K12	Lower Oven Bake Element
K13	Lower Oven Broil Element
K14	Lower Oven Convection Element
K15	Lower Oven Convection Motor

# “CM” DAC RELAY BOARD

(Digital Appliance Controls)

There are 2 relay boards, 1 for a single oven and 1 for a double oven. You can use the double oven board for a single oven. You must use a double oven board for a double oven.

The relay board has 14 snap relays activated by 24 volts d.c., 8 small pin headers that carry *signal voltage* to components, and 5 large pin headers that provide or transfer 120 volts ac to components.

## Relays K0 through K15:

- K0 Transfers 12 volts from transformer to microwave board.
- K1 Transfers 120 volts from L2 to lower oven latch motor.
- K2 Transfers 120 volts from L2 to microwave stirrer motor.
- K3 None
- K4 Transfers 120volts from L2to both oven cooling motors, tube fan, m/w TX and cooling fan.
- K5 Transfers 120 volts from L2 to both oven cooling motors, tube fan, m/w TX and cooling fan.
- K6 Transfers current to complete L2 v.a.c. Upper oven halogen light circuit.
- K7 Transfers current to complete L2 v.a.c. Lower oven halogen light circuit.
- K8 Transfers 120 volts from L2 to upper oven bake element.
- K9 Transfers 120 volts from L2 to upper oven broil element.
- K10 Transfers 120 volts from L2 to upper oven convection element.
- K11 Transfers 120 volts from L2 to upper oven convection motor.
- K12 Transfers 120 volts from L2 to lower oven bake element
- K13 Transfers 120 volts from L2 to lower oven broil element.
- K14 Transfers 120 volts from L2 to lower oven convection element.
- K15 Transfers 120 volts from L2 to lower oven convection motor.

These relays have normally open contacts that transfer voltage when the are snapped closed. These relays have a coil that is snapped closed by 24 VDC from the eeprom (memory chip) on the relay board.

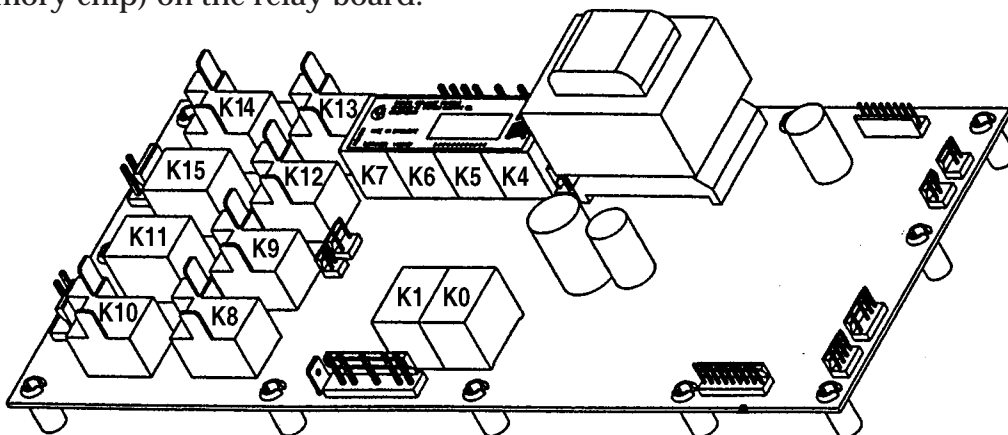



# DAC RELAY BOARD

(continued)

The relay board has 8 small pin headers. They are identified as P2, P3, P5, P6, P9, P10, P11, P14, P15. These small pin headers carry signal voltage to specific components. The pin numbers are identified on the schematic. The illustration below shows that the arrow will always point to Pin#1.

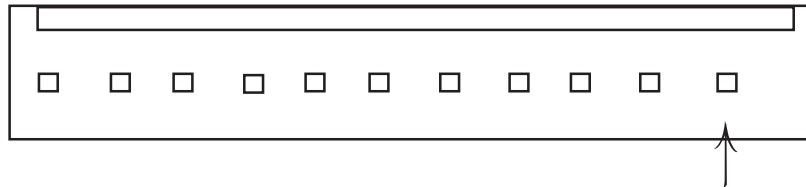

## 8 Small Pin Header Identification:

- P2 Sends current to the lower oven sensor. It is a 3 pin header only #1 and #2 are used. #3 is missing on the pin header and #3 is plugged on the harness so it cannot be miswired.
- P3 Sends current to the upper oven sensor. It is a 3 pin header. only #2 and #3 are used. #1 is missing on the pin header and #1 is plugged on the harness so it cannot be miswired.
- P5 Sends current to the lower oven latch switches. It is a 5 pin header. Only #1,2,3 and 5 are used. #4 is missing on the pin header and is plugged on the harness to prevent miswiring.
- P6 Send 18 VDC to the Microwave board to snap K1 relay closed and 5 VDC to the microwave board to activate the triac.
- P9 Sends current to the upper oven latch switches. It is a 4 pin header. All 4 pins are used.
- P10 Sends current to p10 header on the display head. It is an 8 pin header. All 8 pins are used.
- P11 Sends current to Pl 1 header on the display head. It is a 9 pin header. All 9 pins are used.
- P14 Sends current to the upper oven double line break relay coil. it is a 2 pin header. Both pins are used.
- P15 Sends current to the lower oven double line break relay coil. it is a 3 pin header. Only #1 and #3 are used. #2 is missing on the pin header and is plugged on the harness to prevent miswiring.

# DAC RELAY BOARD

(continued)

The relay board has 5 large pin headers. They are identified as P0, P1, P7, P8, P18. These large pin headers carry current to specific components. The pin numbers are identified on the schematic.

**P0 large pin header has 8 pins and are identified as follows;**

- P0-1 Receives current from center tap of light transformer.
- P0-2 Sends current to microwave board to activate m/w oven door latch.
- P0-3 Blank
- P0-4 Sends 120VAC to lower oven latch motor
- P0-5 Blank
- P0-6 Sends 120 VAC to microwave stirrer motor.
- P0-7 Not used
- P0-8 Blank

**P1 large pin header has 8 pins and are identified as follows;**

- P1-1 Receives current from center tap of halogen light transformer.
- P1-2 Sends current to lower oven halogen lights.
- P1-3 Receives current from center tap of halogen light transformer.
- P1-4 Sends current to upper oven halogen lights.
- P1-5 Blank
- P1-6 Sends current to both cooling motors, tube fan and microwave transformer cooling fan.
- P1-7 Blank
- P1-8 Sends current to both cooling motors, tube fan and microwave transformer cooling fan.

# DAC RELAY BOARD

(continued)

**P7 large pin header has 4 pins and are identified as follows;**

P7-1 Blank

P7-2 Blank

P7-3 Current from L2 to K11 relay

P7-4 Current to upper oven convection motor

**P8 large pin header has 4 pins and are identified as follows;**

P8-1 Current from L2 to K15 relay.

P8-2 Current to lower oven convection motor.

P8-3 Blank

P8-4 Blank

**P18 large pin header has 6 pins and are identified as follows;**

P18-1 Current from L1 to relay board transformer.

P18-2 Blank

P18-3 Neutral from "n" to relay board transformer.

P18-4 Not used

P18-5 Blank

P18-6 Chassis ground

# Explanation of the Wire Harness



The wire harness is shown in the illustration above.

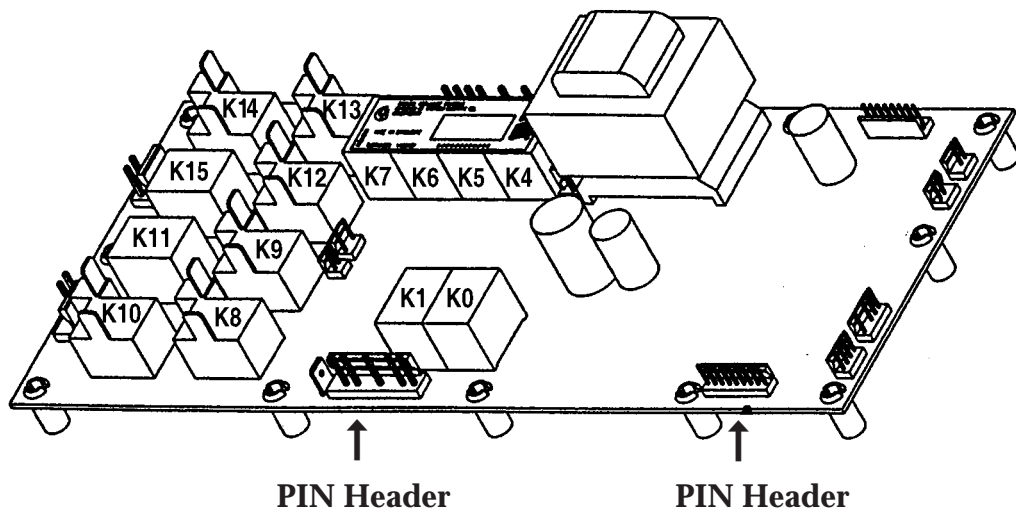

The wire harness' slide onto the pin headers of the relay board, display head, and touch control boards. The illustration above shows the pin headers on the relay board.

# Wire Harnesses

(Continued)

The “CM” oven uses 5 wire harnesses to transfer signal voltage between the DAC control (relay board), display head, and touch control boards (glued on the glass). The 5 wire harness' connect to the corresponding pin headers on the corresponding components (relay board, display head, touch control board). These 5 wire harness' are identified as follows:

## **2 Wire White Power Harness:**

This wire harness has 2 wires and connects from pin header P8 on the display head to pin header P2 1 on the left touch control board. The center hole of the connector is plugged so it cannot be mis-wired. This harness sends 24 volts AC. To the touch control boards.

## **7 Wire White Bridge Harness:**

This 7 wire harness connects from pin header P2 on the left side TCB to pin header P2 on the right side tcb. The #2 hole on the connector housing is plugged (there is no wire). This harness sends commands between the left tcb and the right tcb.

## **8 Wire Yellow Display Harness:**

This 8 wire yellow harness connects from pin header P10 on the display head to pin header P10 on the relay board (right rear corner of relay board). This harness sends display signals from the relay board back to the display head.

## **9 Wire Orange Communication Harness:**

This 9 wire harness connects from pin header P11 on the display head to pin header P11 on the relay board (right front corner of board). This harness sends communication signals from the display head to the relay board.

## **18 Pin White Communication Harness:**

This split wire harness has 18 wires and connects from pin header P1 on the large left side tcb to pin header P1 on the display head. The side with the single connector goes to the display head; the side with the split (2) connector housings goes to the left side TCB. This harness sends communication from both the left and right TCBs to the display head.

# Troubleshooting chart for relay board header pin failures

*Wire harness off at pin header; or circuits open:*

**P2 Lower oven sensor:**

Control functions normal. When sensor opens, f-61 code will appear. If sensor shorts, f-60 will appear. Cooling fan is on constantly.

**P3 Upper oven sensor:**

Controls function normal. When sensor opens, f-31 code will appear. If sensor shorts, f-30 will appear. Cooling fan is on constantly.

**P5 Lower oven door latch:**

Will accept all modes except self clean. When set in self clean, "DOR" will flash and self clean will erase.

**P9 Upper oven door latch:**

Will accept all modes except self clean. When set in self clean, "dor" will flash and self clean will erase

**P10 Sends display signals to display head:**

Glass control panel is completely dead. No display, circuit Must be reset at breaker.

**P11 Sends communication signals to display head:**

Glass control panel is completely dead. No display, circuit must be reset at breaker.

**P0 Upper/lower door latch motors:**

No fail code, will accept all modes except self clean. When either oven is set to self clean, the display will be on constantly, doors will not lock. It will not go into self clean.

**P18 Relay board transformer:**

No fail code, no display at all. Board is dead.

**P1 Both cooling motors and halogen lights:**

Will accept modes. In about 45 seconds F-34 will appear in the upper oven or F-64 will appear in the lower oven because the

Cooling motors did not come on to close the air switches and signal the board. Additionally, the halogen lights in both ovens will not work. All relays will close but the lights and motors will not work.

**P8 Lower oven convection motor:**

No fail code. The lower oven convection motor will not work. The relay will snap closed.

**P7 Upper oven convection motor:**

No fail code. The upper oven convection motor will not work. The relay will snap closed.

**P14 Upper oven double line break relay coil:**

No fail code. If double line break relay does not close, 11 (120 volts) will not reach upper oven bake, broil, convection elements.

**P15 Lower oven double line break relay coil:**

No fail code. If double line break relay does not close, 11 (120 volts) will not reach upper oven bake, broil, convection elements.

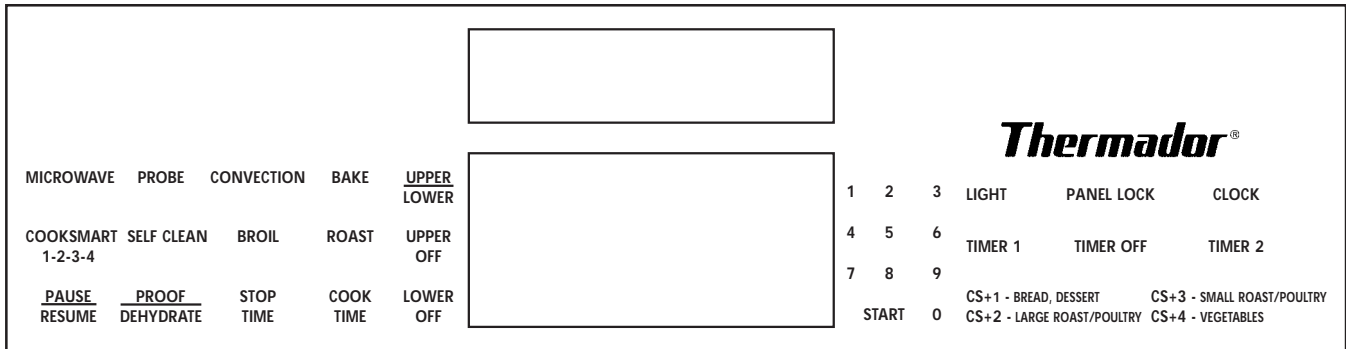

## “CM” OVEN CONTROL PANEL

- **Touch Control Glass**
- **Touch Control Boards**
- **Display Head**



# ELECTRONIC OVEN CONTROLS

## HANDLING THE BOARDS

The Touch Control Board and the Display Head are subject to failure if static electricity is transferred to the components during handling. When handling these parts, use a grounding strap, if available. If not, touch any grounded metal surface, (e.g. the appliance chassis), prior to handling these components.

The replacement Touch Control Board and the Display Head are packaged in antistatic bags. When removing the boards from their bags, handle them as follows:

## Touch Control Board

Handle the Touch Control Board only by the edges of the glass and the plastic frame. **DO NOT TOUCH** the connector pins, or the microprocessor chips.

## Display Head

Handle the Display Head only by the edges of the plastic frame. **DO NOT TOUCH** the connector pins, the microprocessor chip, or jumper wires.

**IMPORTANT NOTE: Repack the old boards in the antistatic bags and original packaging before returning them to a parts distributor.**

## CAUTION

**Power to Oven must be turned OFF before disconnecting or reconnecting wire harnesses to relay board, control panel or display board.**

# Control Panel Assembly

**The control panel assembly is comprised of the following parts;**

**Control panel:**

There are a total of 6 control panels. 2 black, 2 white and 2 stainless. The control panels are what determines the color of the unit.

**Curved glass touch panel:**

There are 2 glass touch panels. One is for the single oven, the other is for the double oven. Both are black in color and both are the same size. The difference between a 27-inch oven and a 30-inch oven is determined by the control panel.

**Mounting brackets:**

There are 6 mounting brackets that hold the glass against the control panel snug. 2 of these brackets mount the display head to the back plate.

**Back plate:**

The back plate is used to put pressure against the glass and hold it in place. The back plate also serves to mount the display head.

**Wire harnesses:**

There are a total of 5 wire harnesses on the control panel. There is 1 orange harness, 1 yellow harness, and 3 white harness'.

**Display head:**

There are 2 display heads; one for the single oven, one for the double oven.

# Glass touch panel

The glass touch panel is comprised of a piece of curved glass with 2 control boards glued onto it.

## Left side touch control board:

The large touch control board is glued on the left side of the curved glass. The large touch control board controls the following 12 modes;

MICROWAVE	PROBE	CONVECTION	BAKE	<u>UPPER</u> LOWER
COOKSMART 1-2-3-4	SELF CLEAN	BROIL	ROAST	UPPER OFF
<u>PAUSE</u> RESUME	<u>PROOF</u> DEHYDRATE	STOP TIME	COOK TIME	LOWER OFF

This control board has 3 pin headers and are identified as P1, P2, P3.

P1 pin header has 21 pins (only 20 are used, #2 is missing) and connects to the display head using 3 harnesses. One harness has 10 wires, one harness has 8 wires and one harness to 2 wires.

P2 pin header has 8 pins (only 7 are used, #2 is missing) and connects to the small right side touch control board.

P3 pin header on the large left side touch control board is not used.

## Right side touch control board:

The small touch control board is glued on the right side of the curved glass and controls the following 7 modes;

1	2	3	LIGHT	PANEL LOCK	CLOCK
4	5	6	TIMER 1	TIMER OFF	TIMER 2
7	8	9			
START	0		CS+1 - BREAD, DESSERT	CS+3 - SMALL ROAST/POULTRY	
			CS+2 - LARGE ROAST/POULTRY	CS+4 - VEGETABLES	

**This control board has 1 pin header and is identified as P2.**

P2 pin header has 8 pins (only 7 are used, #2 is missing), and connects to the large left side control board.

# Display Head

The display head has a total of 8 pin headers (only 7 are used), they are identified as P1, P2, P4, P6, P8, P10 and P11.

**P1 pin header** has 18 pins and connects to the large touch control board (P1).

**P2 pin header** has 2 pins and connects to the meat probe.

**P4 pin header** has 2 pins and connects to the lower oven air switch.

**P6 pin header** has 2 pins and connects to the upper oven air switch and the microwave transformer air switch.

**P8 pin header** has 2 pins and connects to the large touch control board (P1).

**P10 pin header** has 8 pins and connects to the relay board (white harness to P10 on relay board).

**P11 pin header** has 9 pins and connects to the relay board (white harness to P11 on relay board).

# Troubleshooting chart for display head pin header failures

## *Wire harness off at pin header or open circuits*

### **P10 Accepts display signals from relay board:**

Glass control panel is completely dead. No display, circuit must be reset.

### **P11 Accepts communication signals from relay board:**

Glass control panel is completely dead. No display, circuit must be reset.

### **P2 Upper oven meat probe:**

No probe display when probe is inserted. Wont accept program. If probe is shorted, the probe display will be on constantly and the unit will accept no programs at all.

### **P6 Upper oven air switch:**

F-34 will appear if upper oven air switch does not close. If air switch does not close the mode is cancelled after about 45 seconds.

### **P4 Lower oven air switch:**

F64 will appear if lower oven air switch does not close. If air switch does not close the mode is cancelled after about 45 seconds.

### **P8 Power supply to touch control board:**

No fail code, time of day on clock, control panel is dead, no reaction.

### **P1 Display/communication signals to tcb:**

No fail code. Time of day on clock, control panel is dead, no reaction.

# Troubleshooting chart for right side touch control board header pin failures

## *Wire harness off at pin header or circuits open:*

### **P2 Sends commands to display head:**

No fail code. Will not send commands from right side of tcb to display head. Such as numbers 0 through 9 and "start."

# CM LOWER OVEN

Hidden Bake Element  
Under Oven Liner

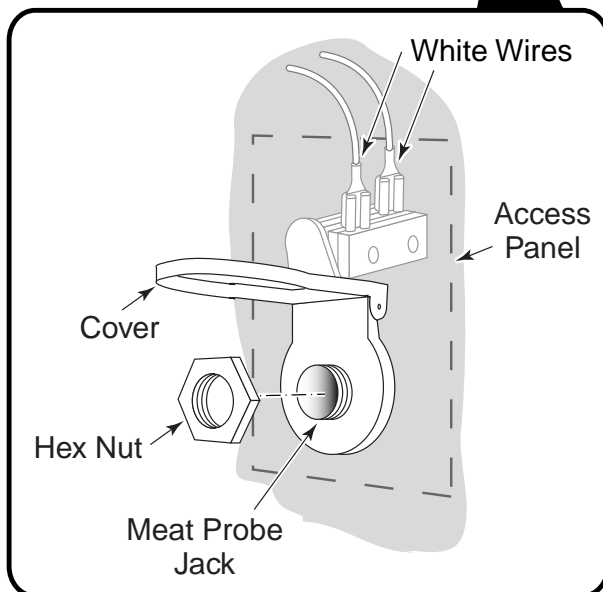
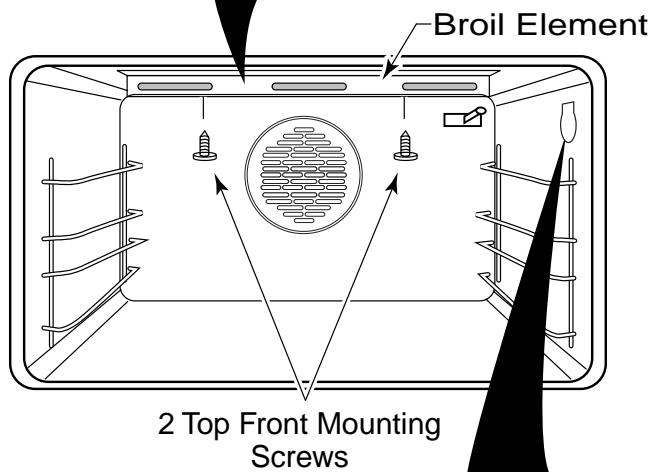
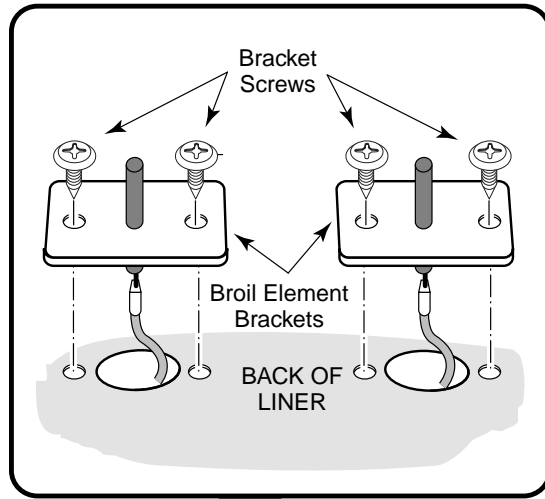
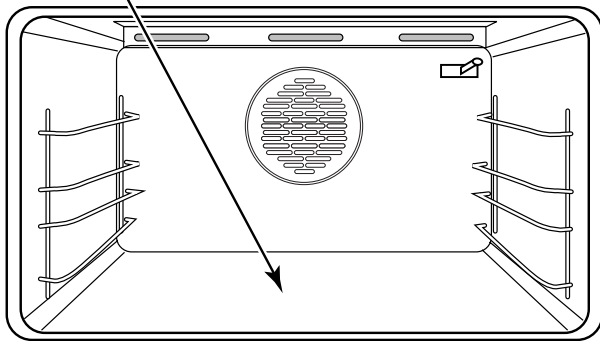

# REMOVING THE HIDDEN BAKE ELEMENT

## (LOWER OVENS ONLY)

### **WARNING**

Turn off the electrical power circuit to the oven at the main junction box before servicing this unit.

### **CAUTION**

When you work on the oven, be careful when handling the sheet metal parts. There are sharp edges present and you can cut yourself if you are not careful.

1. Turn off the electrical power to the oven.
2. Pull the oven out of its mounting location so that you can access the back.
3. Remove the screws from the rear panel and remove the panel (see Figure A, Page 86).

Refer to Figure B (Page 86) for the following steps.

4. Unwrap and remove the indicated wire tie from the support bracket.
5. Remove the three screws from the support bracket and rotate it to the right so you can access the flange at the bottom of the oven.
6. Remove the six screws from the flange.
7. Remove the two wires from the bake element.
8. Refer to Figure C (Page 86) and bend the bottom flange down as far as possible so that you can pull the bake element out from under the unit.

Refer to Figure D (Page 86) for the following steps.

9. Remove the screws from the hidden element cover and remove the cover.
10. Remove the two screws from the hidden bake element and pull the element out from the unit. **NOTE:** Be careful not to tear the insulation under the element.

# REMOVING THE HIDDEN BAKE ELEMENT (LOWER OVENS ONLY)

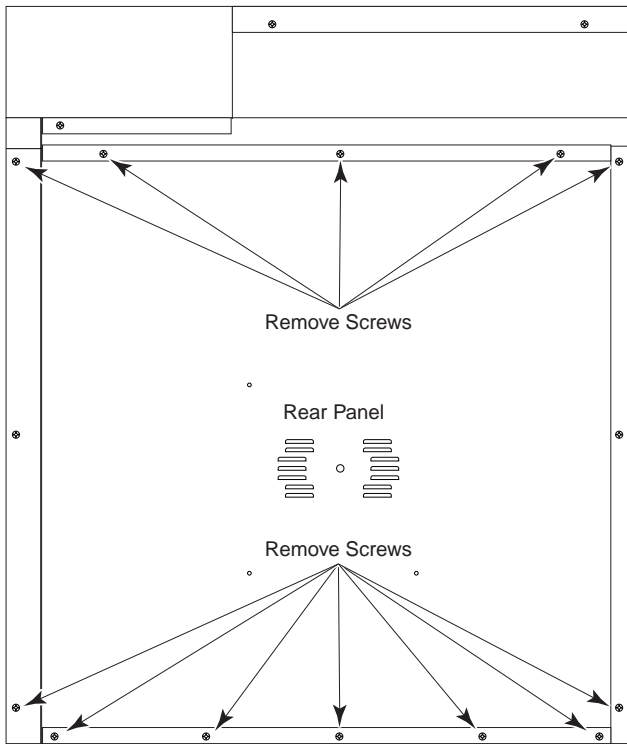

**Figure A**

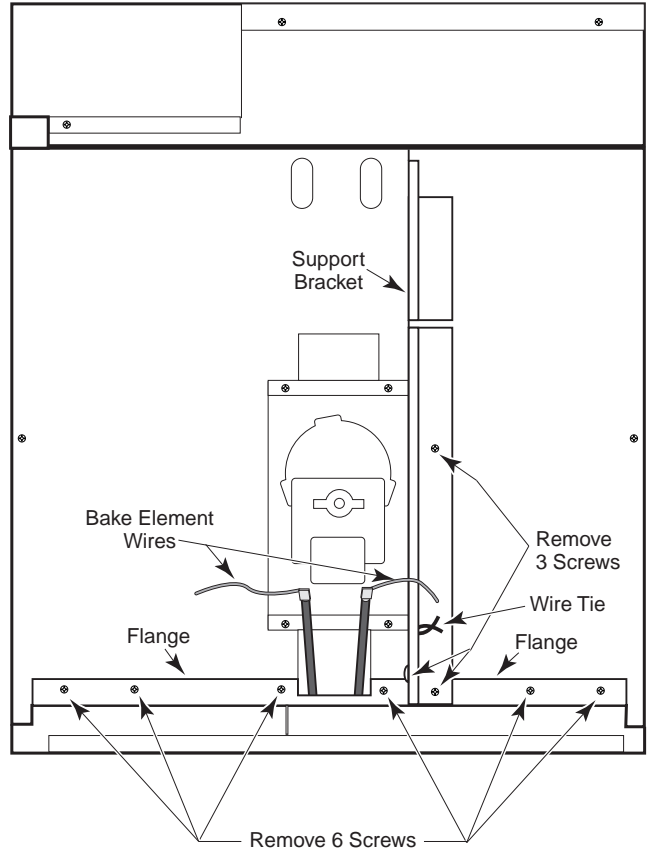

**Figure B**

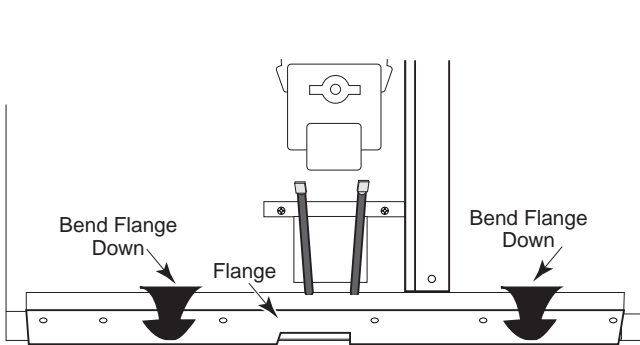

**Figure C**

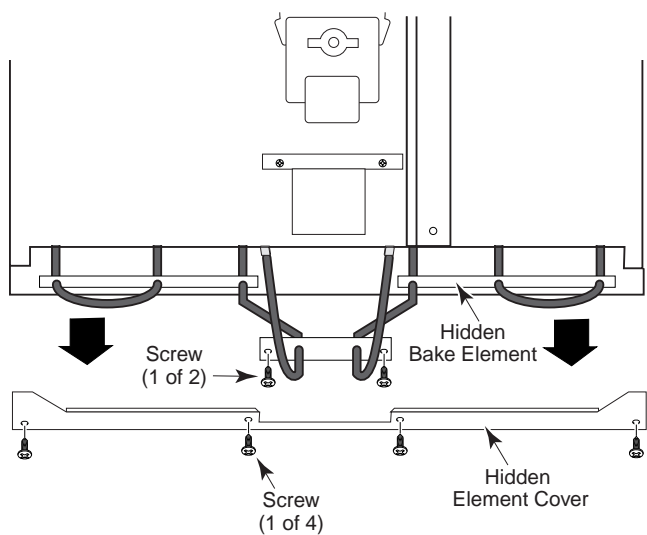

**Figure D**



# REMOVING THE OVEN TEMPERATURE SENSOR

## **⚠ WARNING**

Turn off the electrical power circuit to the oven at the main junction box before servicing this unit.

## **⚠ CAUTION**

When you work on the oven, be careful when handling the sheet metal parts. There are sharp edges present and you can cut yourself if you are not careful.

Refer to illustration, below, for the following steps.

1. Turn off the electrical power to the oven.
2. To make servicing easier, remove the oven door (see Page 99).
3. Remove the racks from the oven.
4. Remove the screws from the bracket and pull the oven temperature sensor forward until the wire connectors are through the opening.
5. Cut the inline splices from the oven temperature sensor and main harness wires.
6. Connect the wires from the new oven temperature sensor to the main harness wires with two red inline splices. After you connect the wires, pull on them to make sure that the inline splices are secure.
7. Use a screwdriver or stiff wire and push the wires into the back of the oven as far as they will go, then install the oven temperature sensor in the oven liner with its two screws.
8. Reassemble the oven.

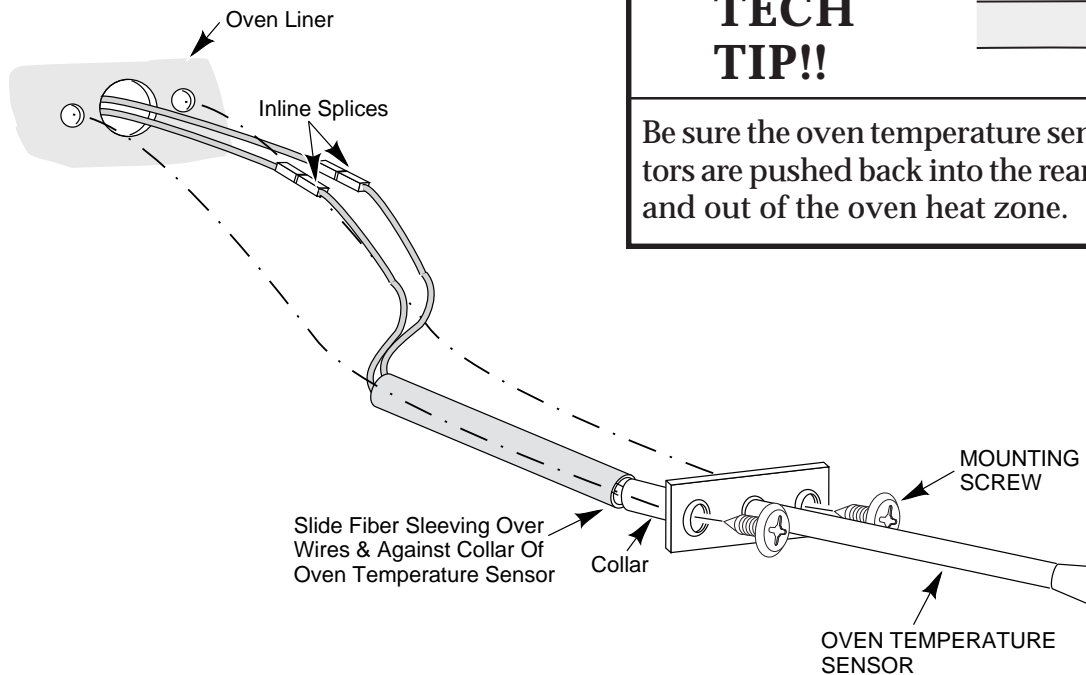

## **TECH TIP!!**

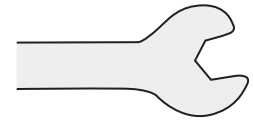

Be sure the oven temperature sensor connectors are pushed back into the rear of the oven and out of the oven heat zone.

# REMOVING THE CONVECTION BAKE ELEMENT

## **⚠ WARNING**

Turn off the electrical power circuit to the oven at the main junction box before servicing this unit.

## **⚠ CAUTION**

When you work on the oven, be careful when handling the sheet metal parts. There are sharp edges present and you can cut yourself if you are not careful.

Refer to illustration, below, for the following steps.

1. Turn off the electrical power to the oven.
2. To make servicing easier, remove the oven

door (see Page 99).

3. Remove the racks from the oven.
4. Remove the front screws from the left and right oven rack supports and remove the supports from the oven liner.
5. Remove the screws from the convection baffle and remove the baffle from the back of the oven liner.
6. Remove the screws from the convection bake element bracket and the screw from the bottom support and pull the element forward, then disconnect the wires from the terminals.
7. Install the new convection bake element and connect the wires to the terminals.
8. Reassemble the oven.

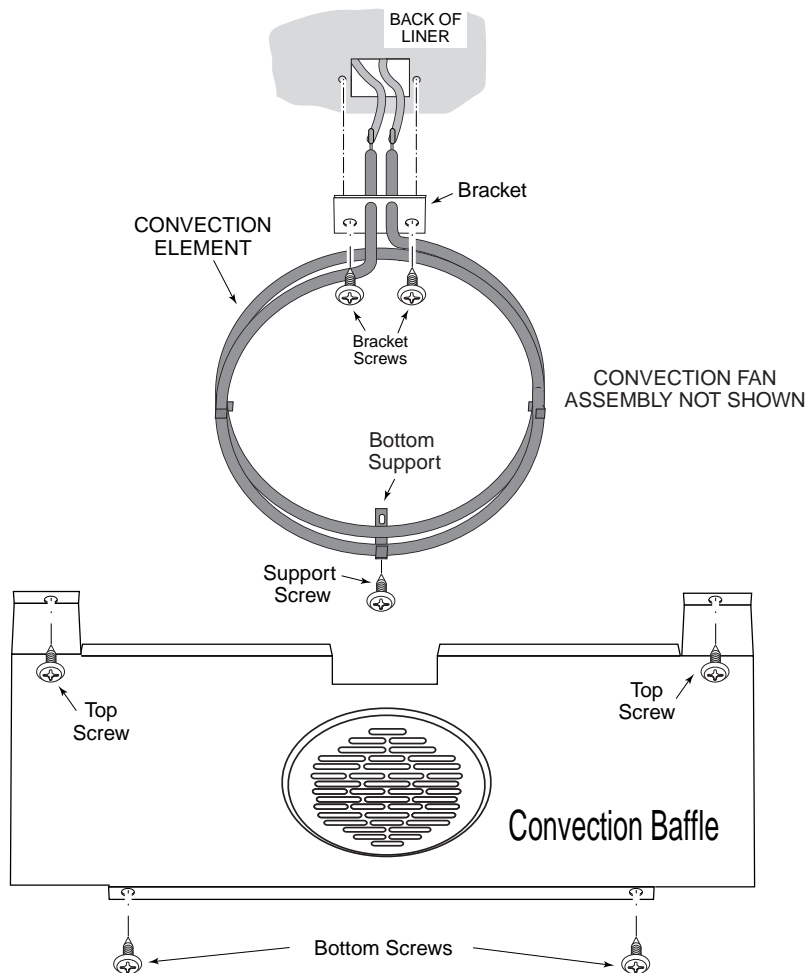

## REMOVING A CONVECTION FAN MOTOR

### **WARNING**

Turn off the electrical power circuit to the oven at the main junction box before servicing this unit.

### **CAUTION**

When you work on the oven, be careful when handling the sheet metal parts. There are sharp edges present and you can cut yourself if you are not careful.

Refer to illustration for the following steps.

1. Turn off the electrical power to the oven.
2. To make servicing easier, remove the oven door (see Page 99).
3. Remove the racks from the oven.
4. Remove the front screws from the left and right oven rack supports and remove the supports from the oven liner.
5. Remove the screws from the convection baffle and remove the baffle from the back of the oven liner.
6. Remove the hex nut from the front of the convection blade. **NOTE:** The nut has left-rotating threads.

### **TECH TIP!!**

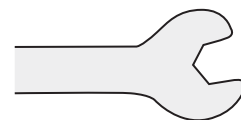

The convection blade hex nut has left-rotating threads.

7. Remove the flat washer and e-ring from the convection blade and remove the blade from the motor shaft.
8. Remove the screws from the pan and remove the pan.
9. Remove the motor screws from the bracket and remove the motor from the bracket.
10. Disconnect the two wires from the fan motor terminals.
11. Connect the brown wire (#45) to the right terminal of the new convection fan motor, and the white wire (#44) to the left terminal, then install the motor assembly.
12. Reassemble the oven.

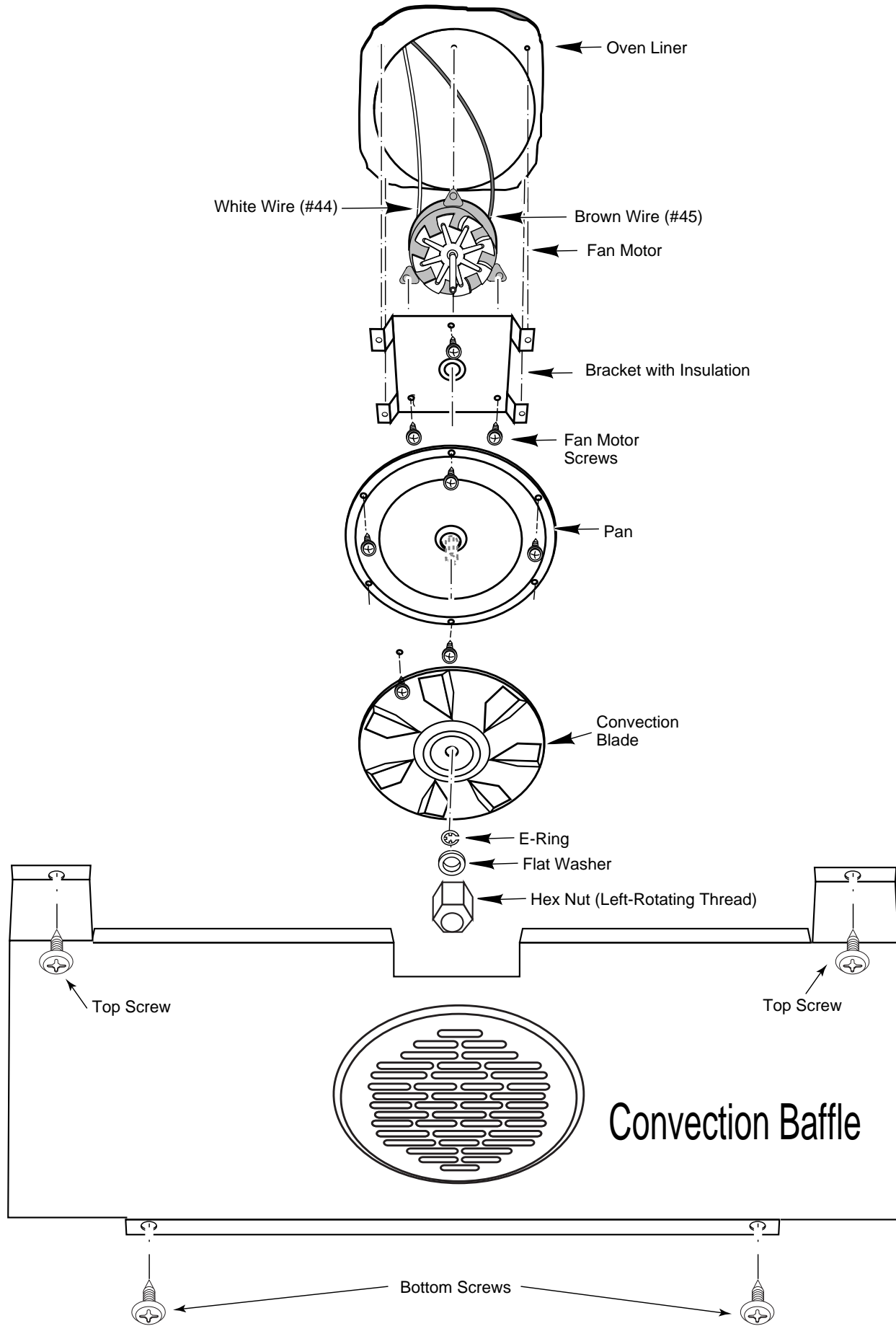

# REMOVING A HALOGEN LAMP HOLDER

## ⚠ WARNING

Turn off the electrical power circuit to the oven at the main junction box before servicing this unit.

## ⚠ CAUTION

When you work on the oven, be careful when handling the sheet metal parts. There are sharp edges present and you can cut yourself if you are not careful.

Refer to illustration, right, for the following steps.

1. Turn off the electrical power to the oven.
2. Remove the oven racks.
3. Remove the oven rack support for the halogen lamp holder you are removing.

**CAUTION:** Make sure that the halogen bulb is cool before you remove it in the next step.

4. Pull the lamp cover out of the halogen lamp holder and remove the bulb.
5. Pry the lamp holder out of the oven liner and cut the wires approximately 2" from the lamp holder body. **CAUTION:** Be careful not to chip or scratch the oven liner when you pry the lamp holder out of the cutout.
6. Cut the plug off the new lamp holder.
7. Connect the cut wires to the new lamp holder with two red inline splices. After you connect the wires, pull on them to make sure that the inline splices are secure.
8. Gently pull the lamp holder wires up into the plenum area until you can see the red wire splices in the plenum area.
9. Reassemble the oven.

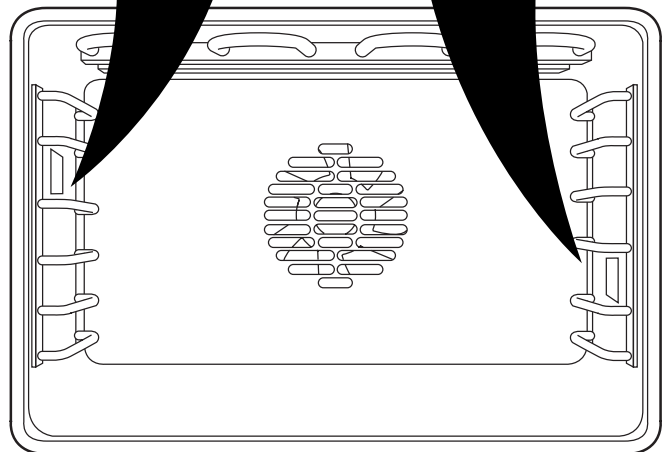
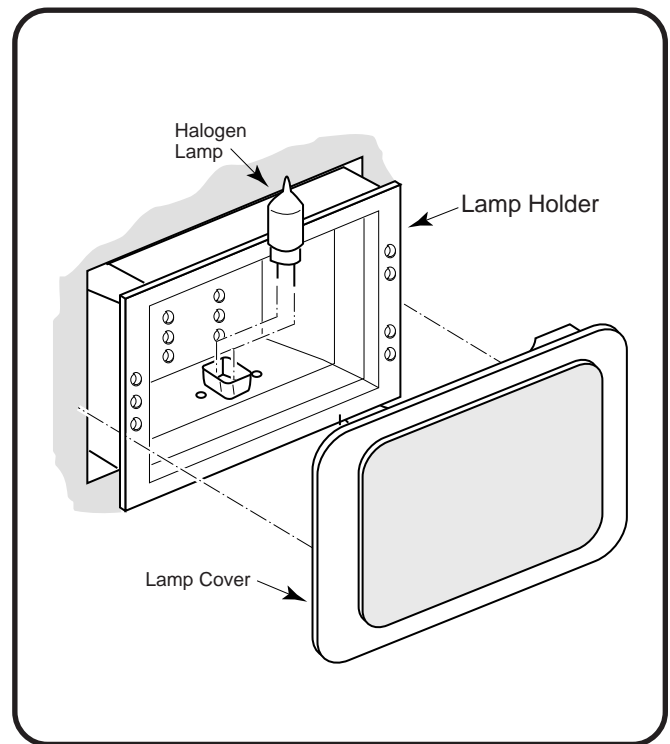

## TECH TIP!!

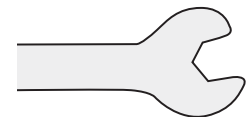

Make sure that the two red inline splices are in the top plenum area and not in the oven heat zone.

# REMOVING THE LAMP TRANSFORMER & LOWER OVEN DOUBLE LINE BREAK RELAY

## ⚠ WARNING

Turn off the electrical power circuit to the oven at the main junction box before servicing this unit.

## ⚠ CAUTION

When you work on the oven, be careful when handling the sheet metal parts. There are sharp edges present and you can cut yourself if you are not careful.

1. Turn off the electrical power to the oven.
2. Open the upper oven door.
3. Remove the control panel and display head (see Page 11 for the procedure).
4. Remove the front subpanel (see Page 10).
5. **To remove the lamp transformer (see illustration, below):**
  - a) Remove the screws and disconnect the wires from the terminals.
  - b) Install the new lamp transformer and reconnect the wiring.

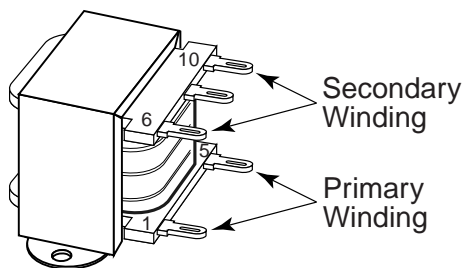

6. **To remove an old oven relay (see Illustration, below):**
  - a) Remove the screws and disconnect the wires from the relay terminals.
  - b) Install the new oven stalled fan relay with the terminals positioned as shown and reconnect the wiring.

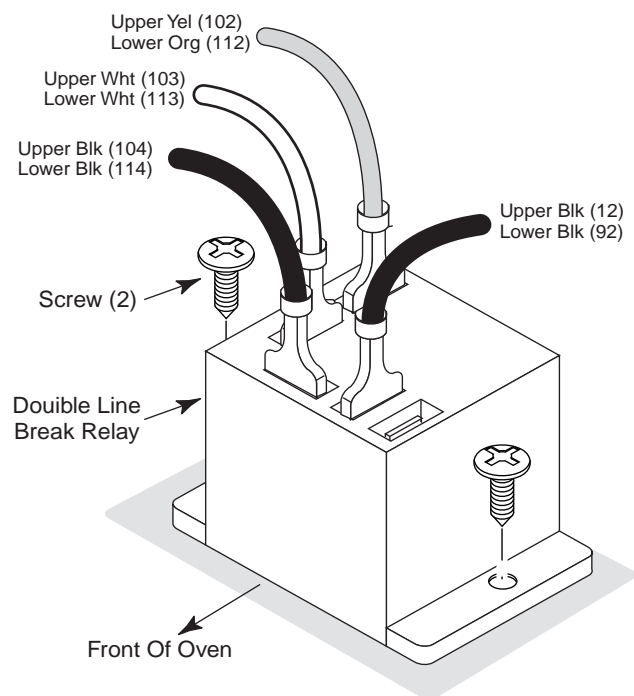

7. Reassemble the oven.

## REMOVING the OVEN LIGHT SWITCH, the OVEN DOOR LATCH ASSEMBLY and the HI-TEMP CUTOUT in LOWER OVEN

### **⚠ WARNING**

Turn off the electrical power circuit to the oven at the main junction box before servicing this unit.

### **⚠ CAUTION**

When you work on the oven, be careful when handling the sheet metal parts. There are sharp edges present and you can cut yourself if you are not careful.

Refer to illustration on Page 94 for the following steps.

1. Turn off the electrical power to the oven.
2. Open the oven door for the component you wish to remove.
3. **To remove the lower air vent grille**, remove the two front oven door latch screws, (see illustration, below), then pull the posts on the ends of the air vent grille out of the catches in the chassis.
4. **To remove the oven light switch**, disconnect the wires from the terminals, press in on the locking arms, and push the switch out of the vent (see Inset 1, Page 94).
5. **To remove the oven door latch assembly (see Inset 2, Page 94):**
  - a) Use a 1/4" ratchet and a 1/4" thin-wall socket and remove the two front hex-head screws from the latch bracket.
  - b) Pull the latch assembly to the right so that the flange on the left side clears the bracket, and then pull it forward as far as the wires will allow.
  - c) Remove the wires from the switch connectors and the motor wires from the main harness.
  - d) **To replace a door lock or door unlock switch on the latch assembly**, remove the two screws from the switch body, and remove the switch.
6. **To remove the hi-temp cutout (see Inset 3, Page 94):**
  - a) Remove the two 1/4" hex-head screws from the bracket.
  - b) Remove the hi-temp cutout and disconnect the wires.
7. Install the replacement component.
8. Reassemble the oven.

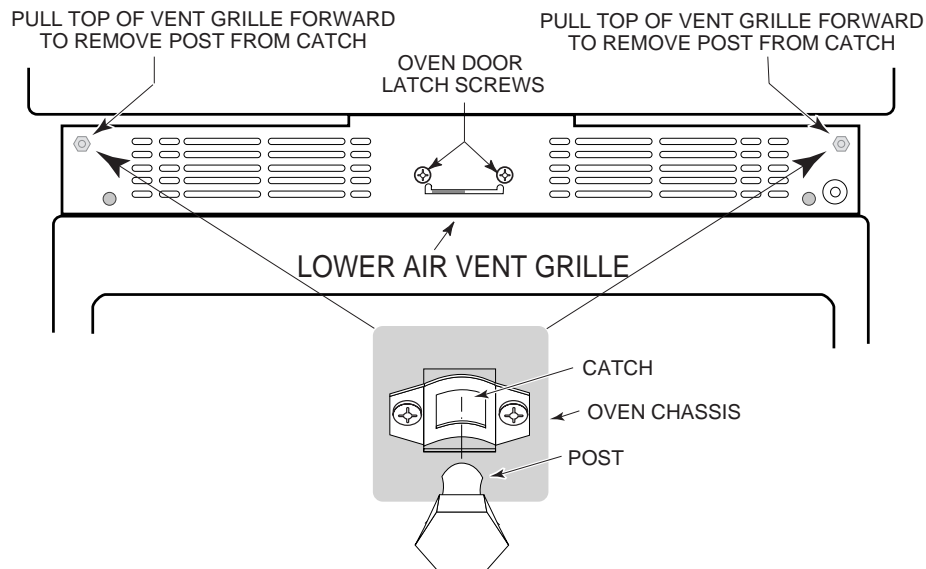

# REMOVING the OVEN LIGHT SWITCH, the OVEN DOOR LATCH ASSEMBLY and the HI-TEMP CUTOUT

## TECH TIP!!

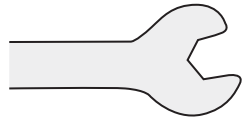

You will need the following tools to remove the components:

- 1/4" ratchet
- 1/4" thin-wall socket
- #2 Phillips Offset Screwdriver

**Inset 1**

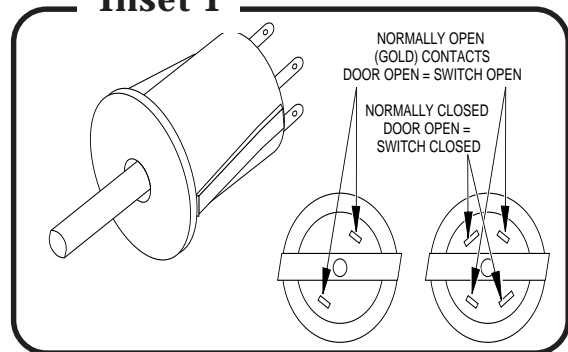

**OVEN DOOR LATCH SCREWS**

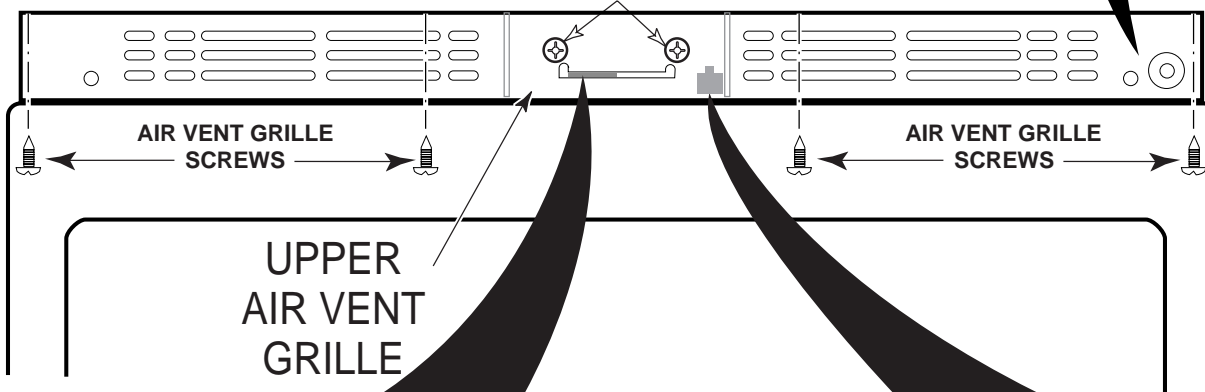

**Inset 2**

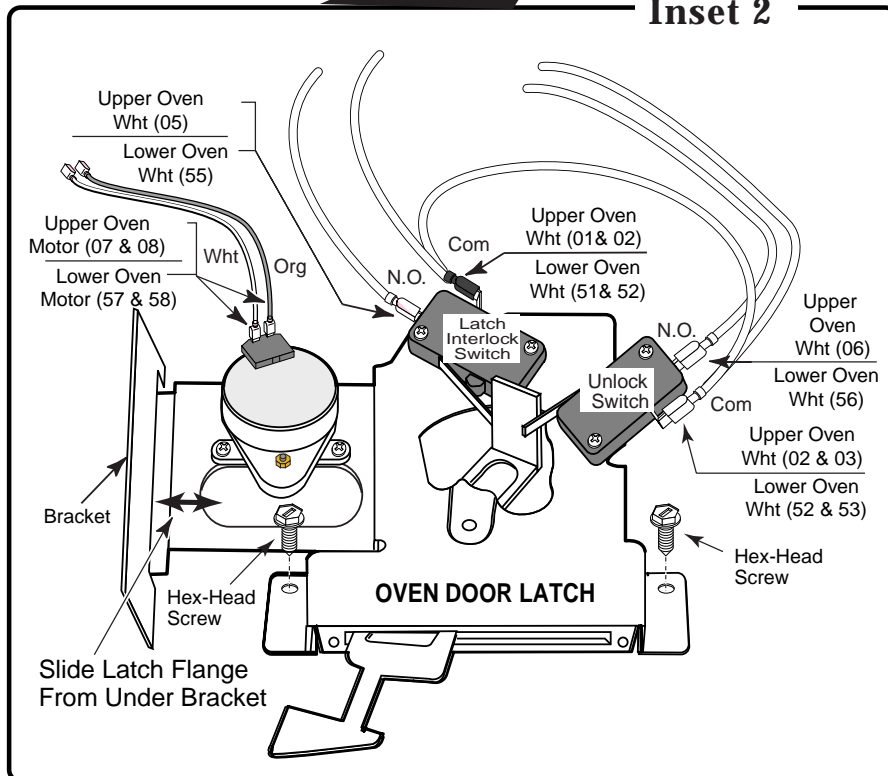

**Inset 3**

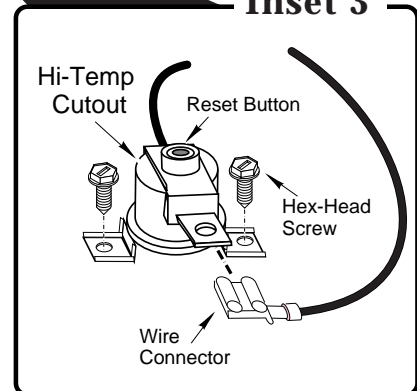



# REMOVING THE AIR SWITCHES

## ⚠ WARNING

Turn off the electrical power circuit to the oven at the main junction box before servicing this unit.

## ⚠ CAUTION

When you work on the oven, be careful when handling the sheet metal parts. There are sharp edges present and you can cut yourself if you are not careful.

NOTE: The air flow to the air switch in the lower oven base compartment of all 27" S-Series ovens has been improved with the addition of an air diverter (#16-10-101). This improvement has been made to all 27" and 30" ovens built in 1998. The new air diverter is located on the right side of the lower oven base compartment (see illustration below). If you encounter a 27" oven that was built in 1997 with no oven heat, due to the air switch not closing, order and install the new diverter. You will not see any error code messages in control display window if these problems occur. Refer to illustration on Page 96 for the following steps.

1. Turn off the electrical power to the oven.
2. Open the lower oven door. The bottom trim mounting screws (see Inset 1, Page 96) are visible at each side of the oven door, below the left and right hinges.
3. Remove the two screws from the bottom trim, pull it forward, and remove it.
4. Remove the two front switches from the air switch bracket and flange, and pull the air switch bracket assembly forward so you can access the switches (see Inset 2, Page 96).
5. To remove an air switch from the bracket, remove the two screws from the switch body, and disconnect the wires from the terminals (see Inset 3, Page 96).
6. Install the new air switch in the mounting bracket.
7. If you intend to install the air switch diverter, do so at this time. Make sure that the spacing between the air switch paddle and the end of the diverter is as shown below.
8. Reassemble the oven.

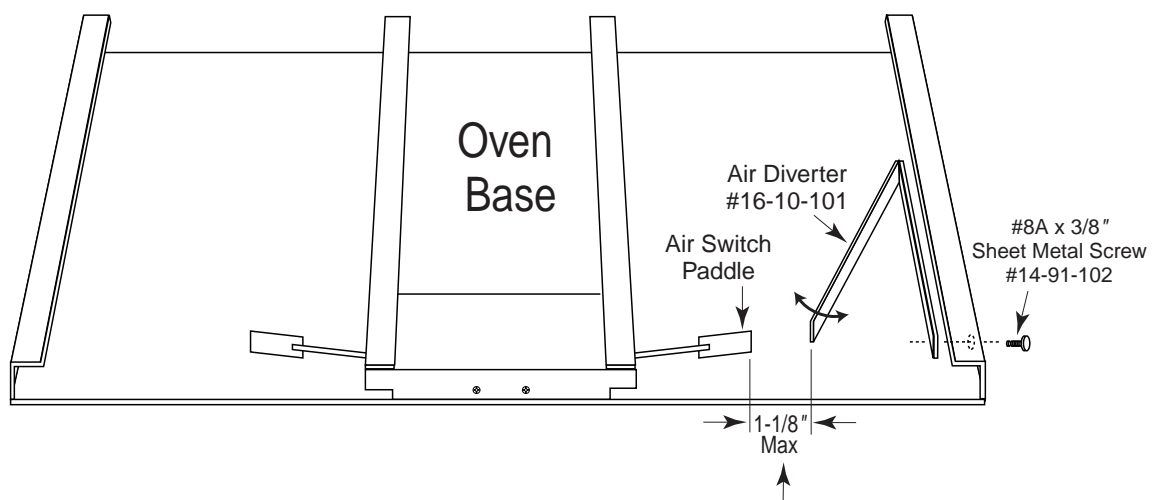

NOTE: After mounting the air diverter, bend the arm, as necessary, so that the space between the air switch paddle and the end of the arm is as shown.

# REMOVING THE AIR SWITCHES

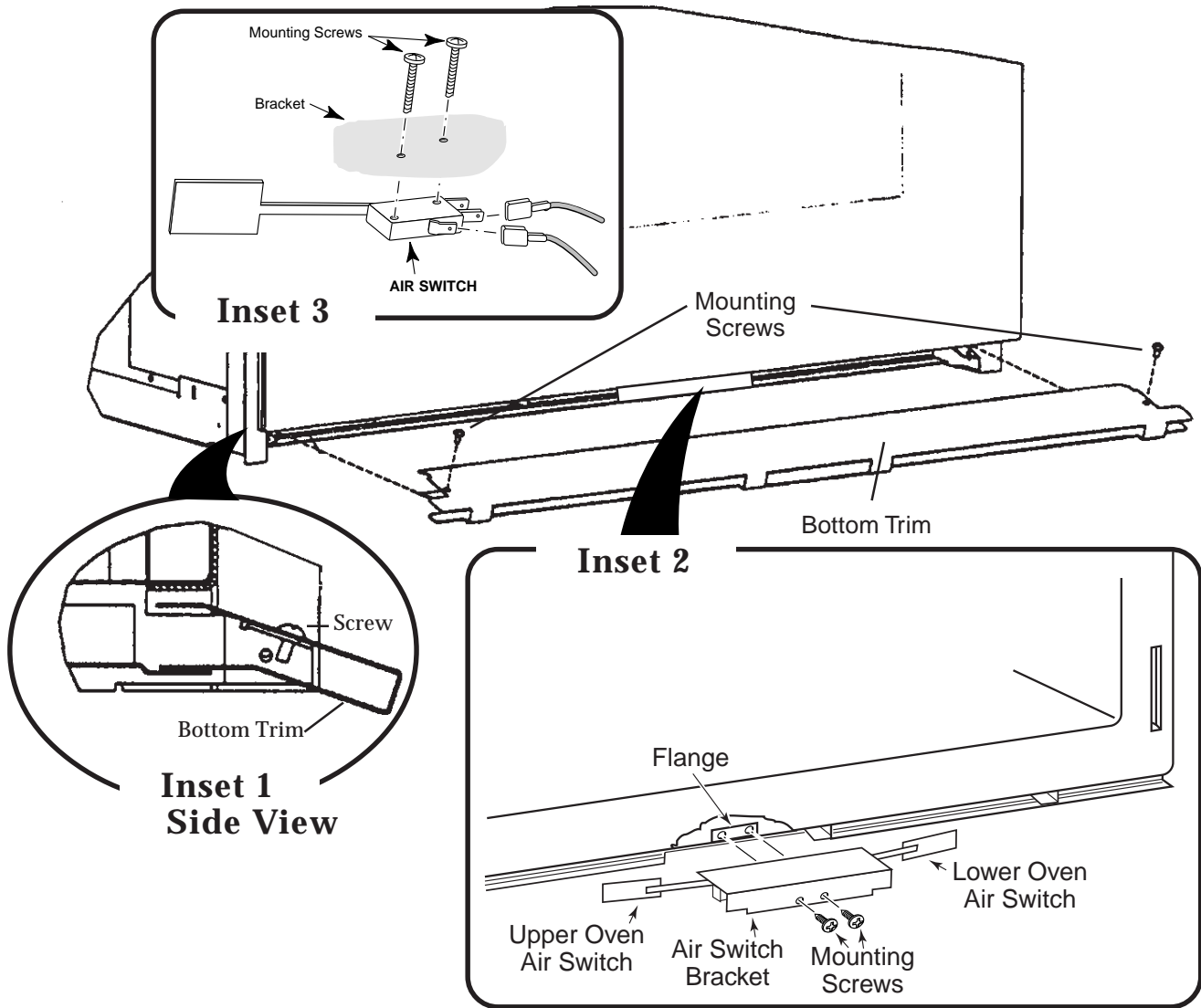

# REMOVING A BLOWER

## WARNING

Turn off the electrical power circuit to the oven at the main junction box before servicing this unit.

## CAUTION

When you work on the oven, be careful when handling the sheet metal parts. There are sharp edges present and you can cut yourself if you are not careful.

1. Turn off the electrical power to the oven.
2. To make servicing easier, remove the oven door (see Page 99).
3. **To remove the upper blower (see Figure A, Page 5-98):**
  - a) Remove the oven from the wall.
  - b) Remove the screws from the front and rear plenum covers and remove the covers (see Page 10 for the procedure).
  - c) Remove the three screws from the blower motor bracket on the back of the plenum and turn the assembly around so that the back faces you.
  - d) Remove the three screws that mount the motor to the bracket.
  - e) Disconnect the four wires from the motor terminals.
  - f) Install the new blower in the mounting bracket and mount the assembly to the plenum.
4. **To remove the lower blower (see Figure B, Page 5-98):**
  - a) Remove the oven from the wall.
  - b) Remove the rear panel from the oven.
  - c) Remove the four bracket screws (1,2,6, & 7) from the back of the oven.
  - d) Remove the three blower screws (3, 4, & 5) from the bracket and remove the motor.
  - e) Loosen the wire ties and remove the two motor wires from the rest of the wire harness.
  - f) Install the new blower in the mounting bracket, mount the assembly to the back of the oven, and connect the wires.
  - g) Install the motor wires in the wire harness ties with the rest of the wires and dress them neatly.
5. Reassemble the oven.

# REMOVING A BLOWER

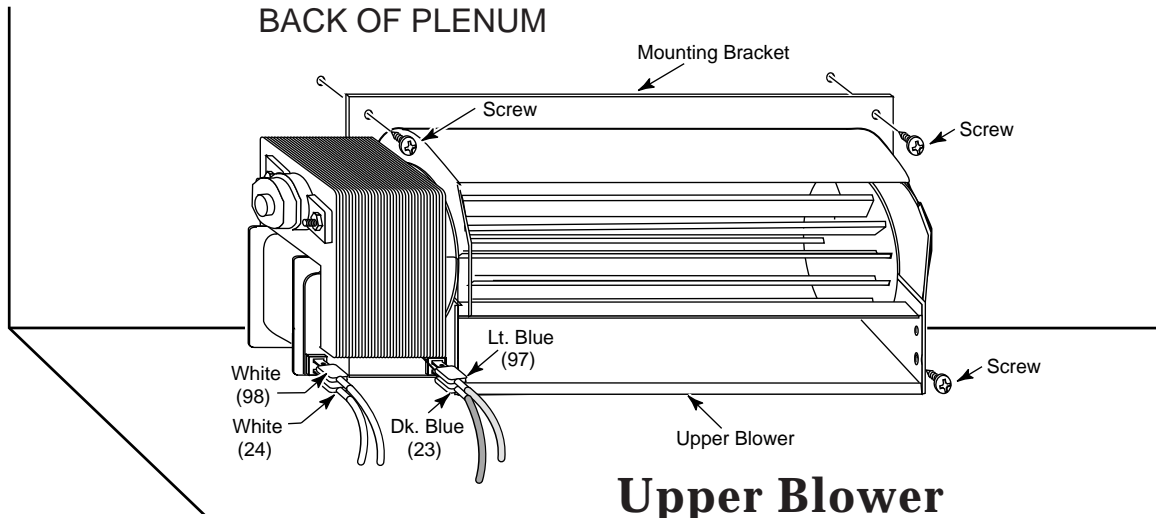

**Upper Blower**  
**Figure A**

**Lower Blower**  
**Figure B**

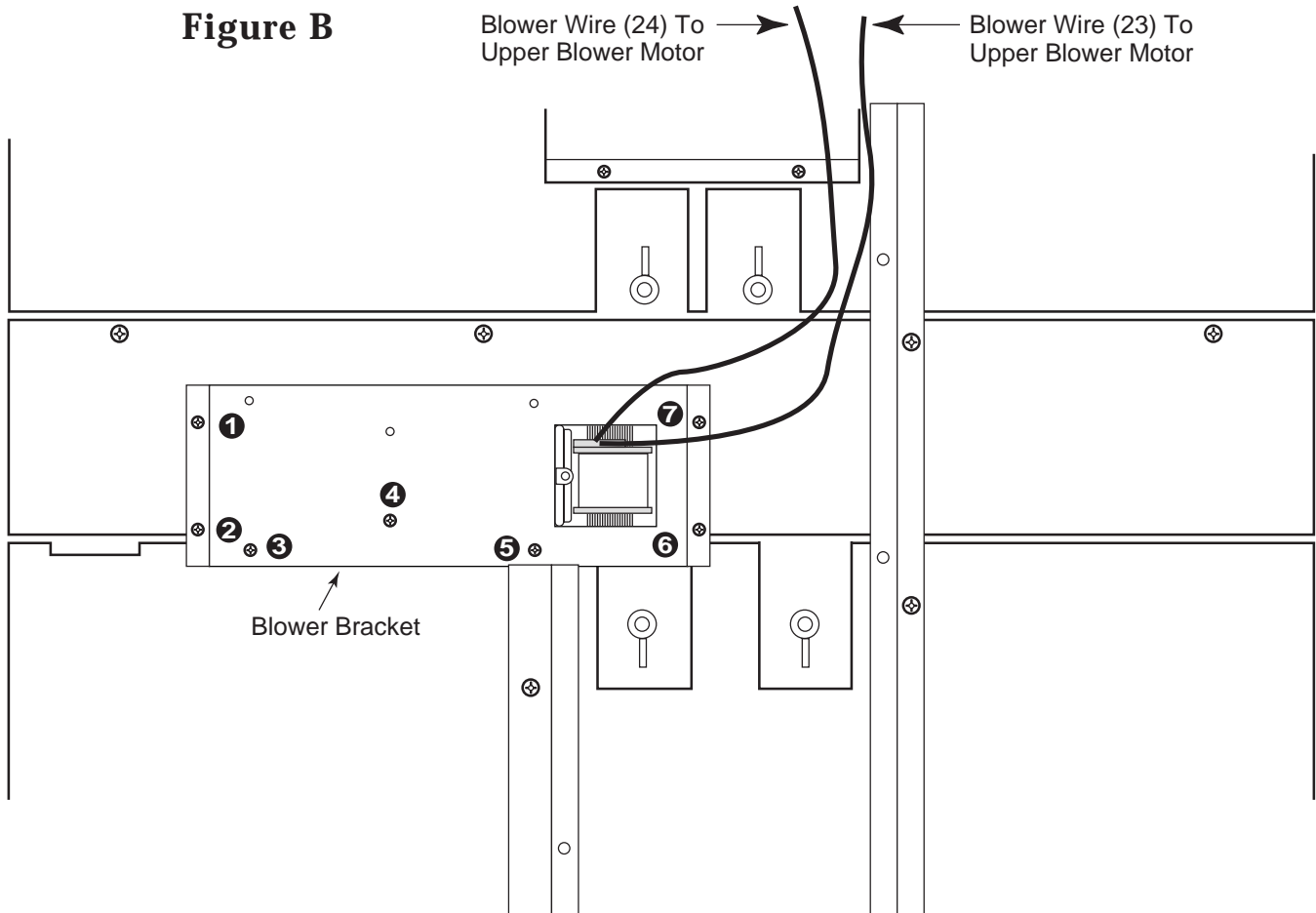

# REMOVING AN OVEN DOOR

Refer to the illustration below for the following steps.

1. Open the door to its fully open position.
2. Raise the hinge latch over the hook on each of the hinges.
3. **To remove the door:**
  - a) Grasp the door by the sides toward the back and raise the front of the door several inches (there will be some resistance in the spring mechanism because the hinge is locked).
  - b) When the door is high enough, lift it until the hinges clear the indents, and pull it out of the slots in the front frame.

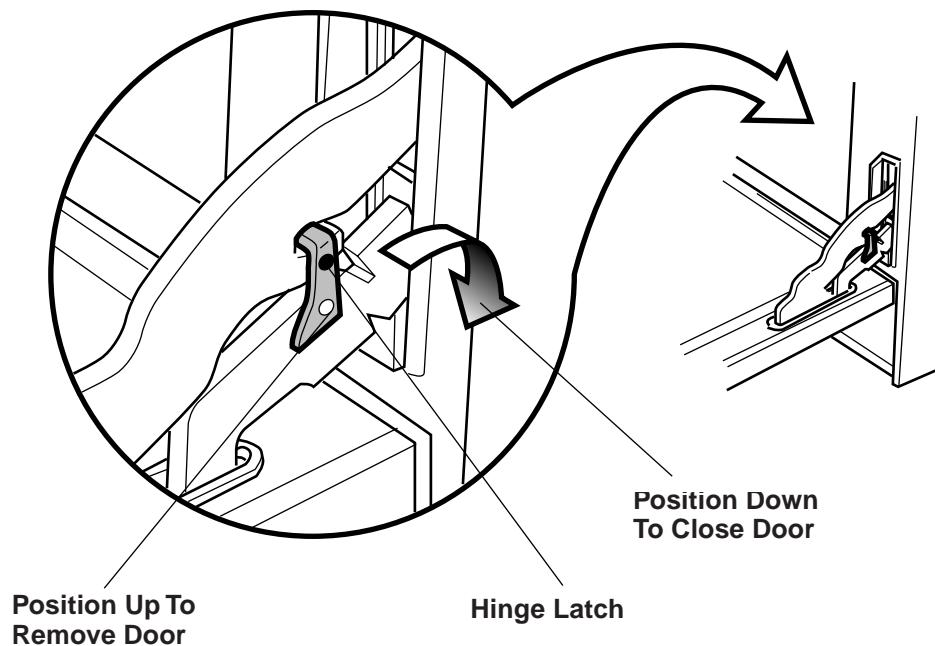

# REMOVING THE OVEN DOOR GASKET

## ⚠ CAUTION

When you work on the oven, be careful when handling the sheet metal parts. There are sharp edges present and you can cut yourself if you are not careful.

**CAUTION:** Before you replace the fiberglass gasket on the oven door, make sure that the oven control is turned OFF, and that the oven is cool.

Refer to illustration, below, for the following steps.

1. Open the oven door to its fully open position.
2. Pull the ends of the old gasket out of the holes in the door (see Inset 1 on the illustration).
3. Working from one end of the gasket to the other, carefully pull the clips that are attached to the gasket out of the holes in the oven door (see Inset 2 on the illustration).
4. Position the new fiberglass gasket around the oven door so that the clips are near the holes.
5. Working from one end of the gasket to the other, insert the gasket clips into the holes in the oven door. NOTE: Once inserted, gently pull on the clip to make sure that it is locked into place.
6. Using the eraser end of a pencil, push the ends of the gasket fully into the holes in the oven door.
7. Check the entire gasket to make sure that all of the clips are properly inserted, and that it is flush and even with the surface of the door.
8. Close the oven door and check to make sure that the gasket fits firmly and evenly with the front of the oven.

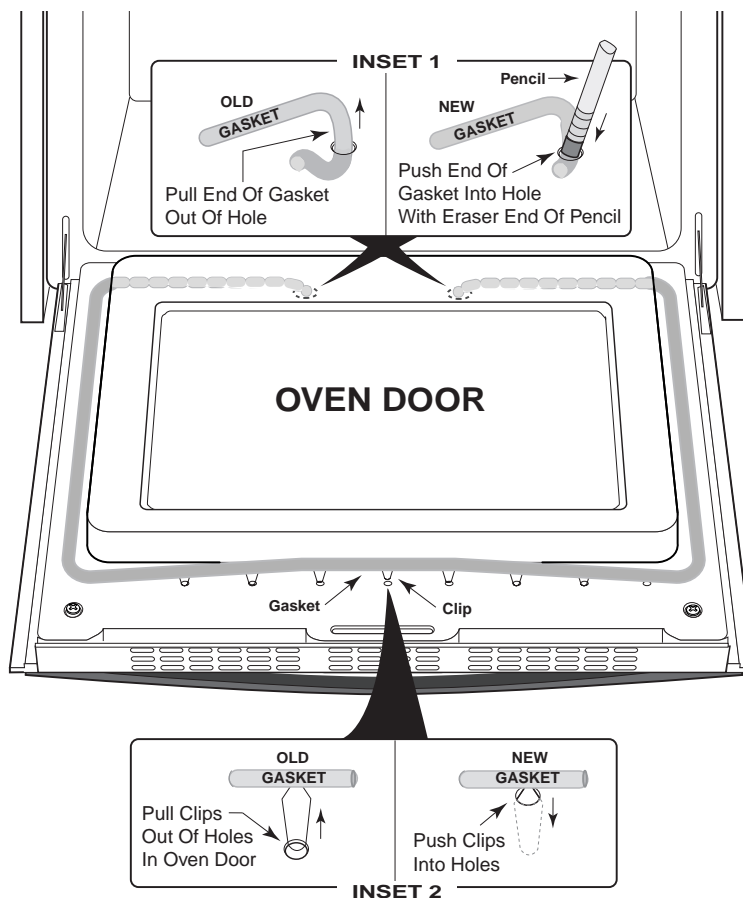

# REMOVING THE OVEN DOOR COMPONENTS

## ⚠ CAUTION

When you work on the oven, be careful when handling the sheet metal parts. There are sharp edges present and you can cut yourself if you are not careful.

1. To remove any of the oven door components, remove the oven door from the oven (see Page 99).
2. Refer to illustration, below, as you remove the door components. The illustration shows the order of removal.

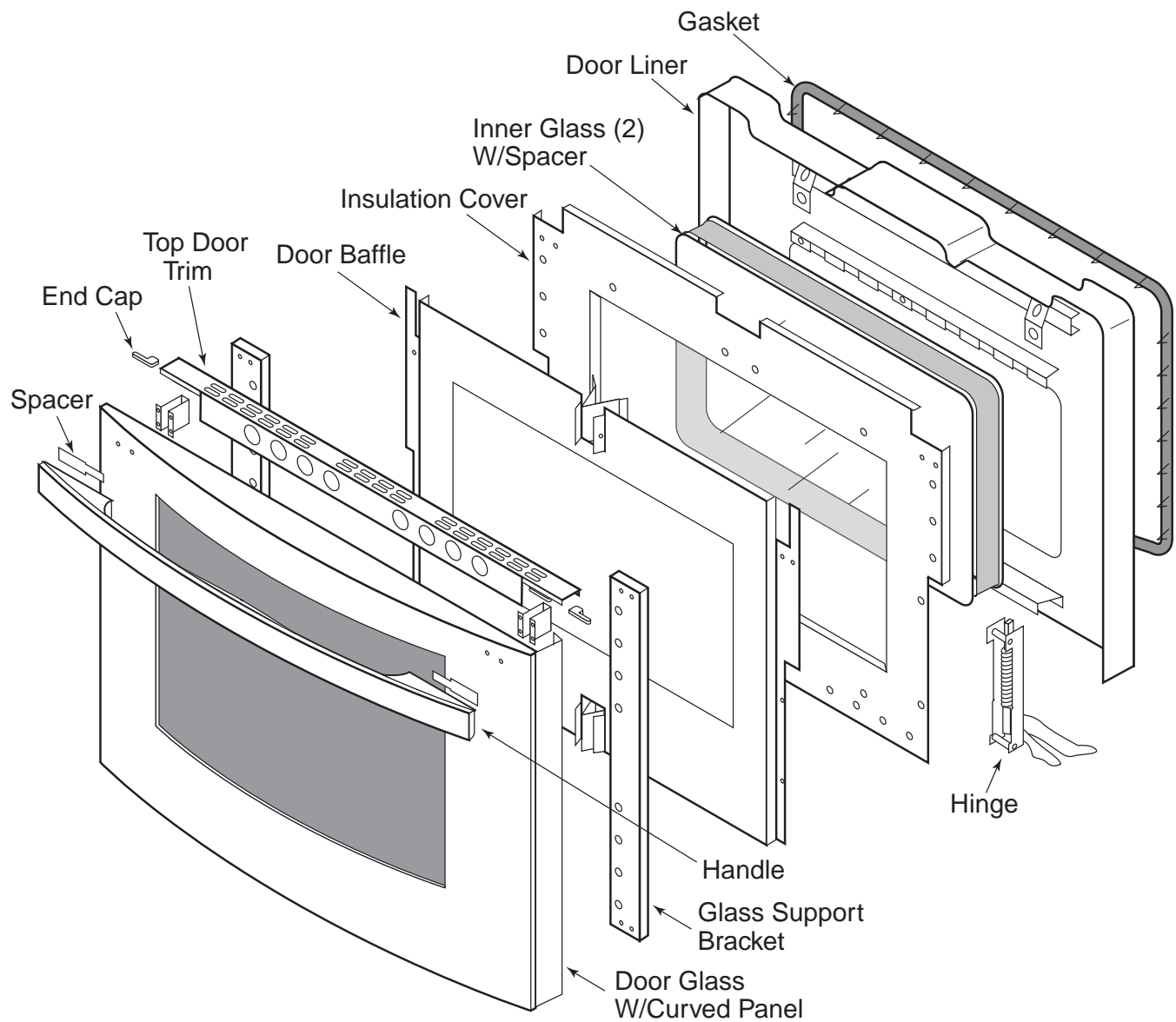

# REMOVING THE OVEN MODULE

## (30") Convection Kit—#35-00-687

### **⚠ WARNING**

Turn off the electrical power circuit to the oven at the main junction box before servicing this unit.

### **⚠ CAUTION**

When you work on the oven, be careful when handling the sheet metal parts. There are sharp edges present and you can cut yourself if you are not careful.

1. Turn off the electrical power to the oven.
2. To make servicing easier, remove the oven door (see Page 99).
3. Remove the oven from the wall.
4. Remove the components from the oven, shown in illustration, below. Refer to the sections in this manual for the procedures on removing the components.
5. With all of the oven components removed, remove the six screws (three on each side) from the front sides of the oven can.
6. Pull the oven can forward and remove it.

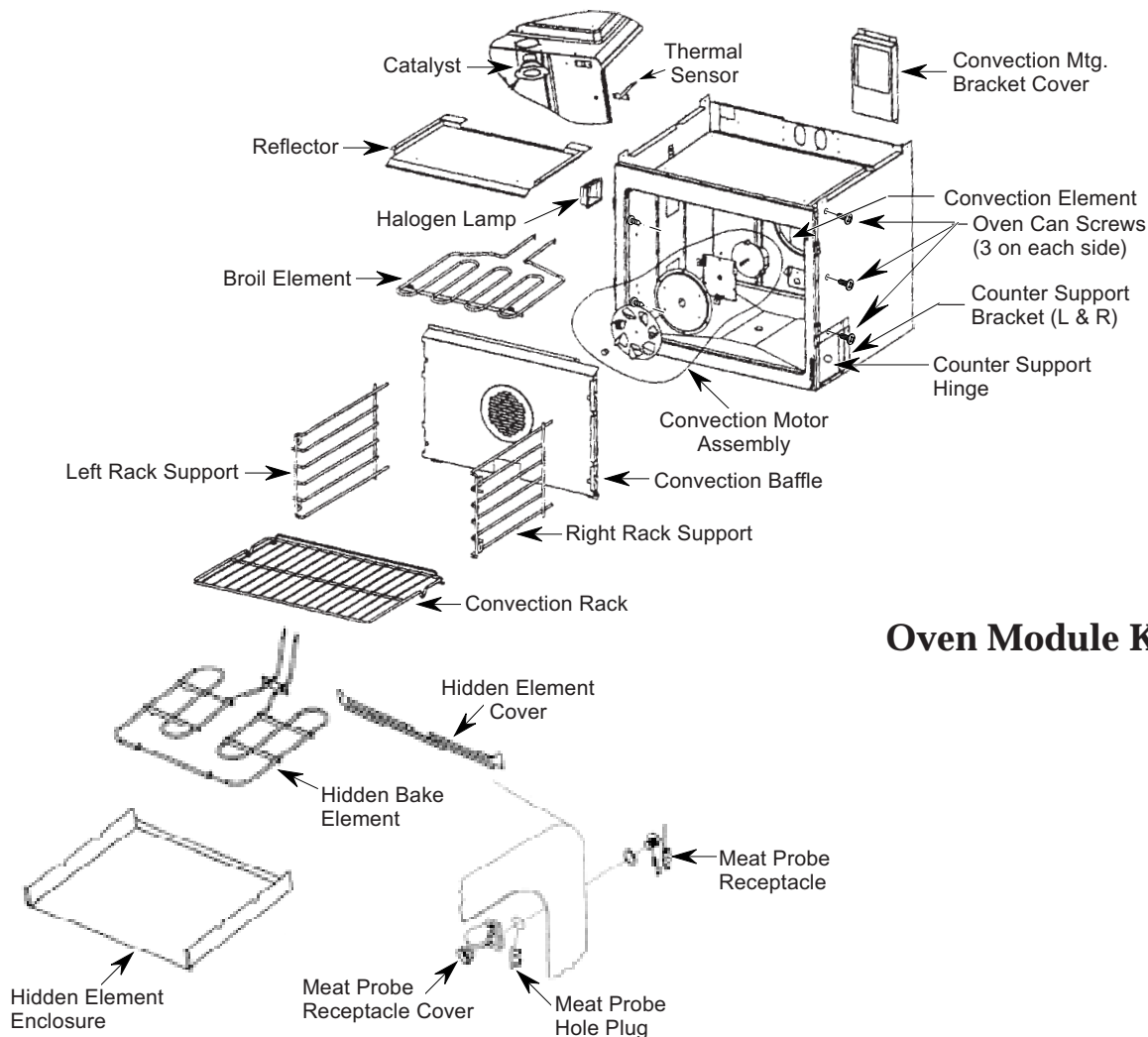

### Oven Module Kit



# TROUBLESHOOTING

## TESTING THE COMPONENTS

### **⚠ WARNING**

TO AVOID ELECTRICAL SHOCK

- DISCONNECT THE POWER TO THE APPLIANCE BEFORE SERVICING.
- FOR THOSE CHECKS REQUIRING THE USE OF ELECTRICAL POWER, EXERCISE EXTREME CARE.
- DO NOT PERFORM HIGH-VOLTAGE TESTS.

### THE BLOWER MOTOR

Refer to Page 97 to access the blower motor.

1. With no power applied, disconnect the motor wire connectors from their terminals.
2. Set the ohmmeter to the R x 1 scale.
3. Touch the ohmmeter leads to the motor terminals. The meter should indicate 13  $\Omega$ .
4. If the reading is not correct, remove and replace the blower motor.

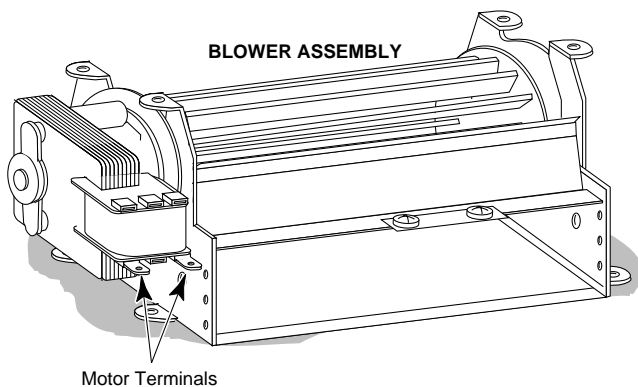

### THE AIR SWITCH

Refer to Page 95 to access the air switch.

1. With no power applied, remove the wire connectors from the terminals.
2. Set the ohmmeter to the R x 1 scale.
3. Connect one of the ohmmeter leads to the common (C) terminal of the switch (the terminal callouts are stamped on the switch).
4. Touch the free ohmmeter lead to the N.O. (normally-open) switch terminal. The meter should show no continuity with the switch in its normal position, and continuity when it is activated.
5. If the readings are not correct, remove and replace the switch.



## THE CONVECTION FAN MOTOR

Refer to Page 89 to access the convection fan motor.

1. With no power applied, disconnect the motor wire connectors from their terminals.
2. Set the ohmmeter to the R x 1 scale.
3. Touch the ohmmeter leads to the motor terminals. The meter should indicate 12  $\Omega$ .
4. If the reading is not correct, remove and replace the convection fan motor.



Convection Fan Motor

## THE LAMP TRANSFORMER

Refer to Page 92 to access the lamp transformer.

1. With no power applied, remove the wires from the terminals of the lamp transformer.
2. Set the ohmmeter to the R x 1 scale.
3. Touch the ohmmeter leads to the primary terminals. The meter should indicate 9  $\Omega$ .
4. Touch the ohmmeter leads to the secondary terminals. The meter should indicate 2  $\Omega$ .
5. If the readings are not correct, remove and replace the lamp transformer.

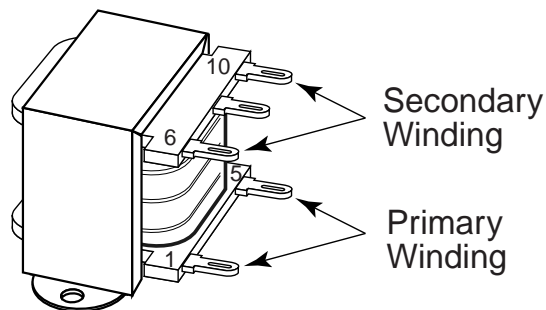

## THE OVEN DOOR LATCH ASSEMBLY

The oven door latch locks the oven door during the *CLEAN* cycle (see the illustration at the bottom of the next column for the various latch positions). Refer to Page 93 to access the oven door latch assembly.

To test one of the latch switches:

1. With no power applied, remove the wire connectors from the switch terminals.
2. Set the ohmmeter to the R x 1 scale.
3. Connect one of the ohmmeter leads to the common (C) terminal of the switch.
4. Touch the other ohmmeter lead to the N.O. (normally-open) switch terminal. The meter should indicate no continuity with the switch in its normal position, and continuity when it is activated.

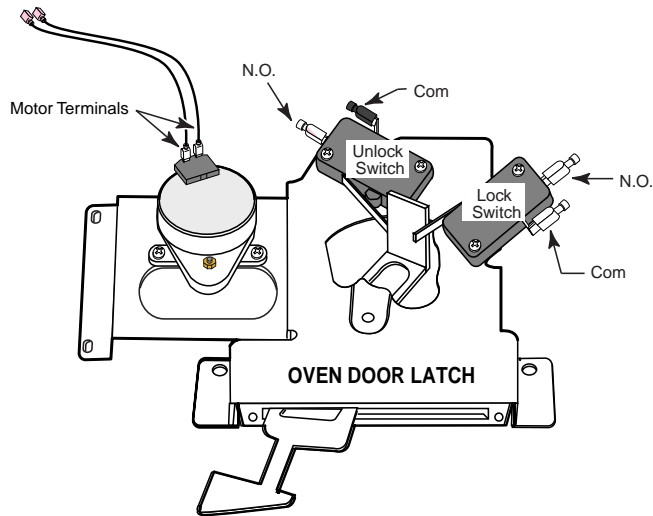

5. If the reading is not correct, remove and replace the switch.

To test the door latch motor windings:

1. With no power applied, disconnect the motor wires from the terminal block and main harness connector.
2. Set the ohmmeter to the R x 100 scale.
3. Touch the ohmmeter leads to the motor wire connectors. The meter should read between 700  $\Omega$  and 750  $\Omega$ .
4. If the reading is not within this range, remove and replace the door latch assembly.

### Door Latch Positions

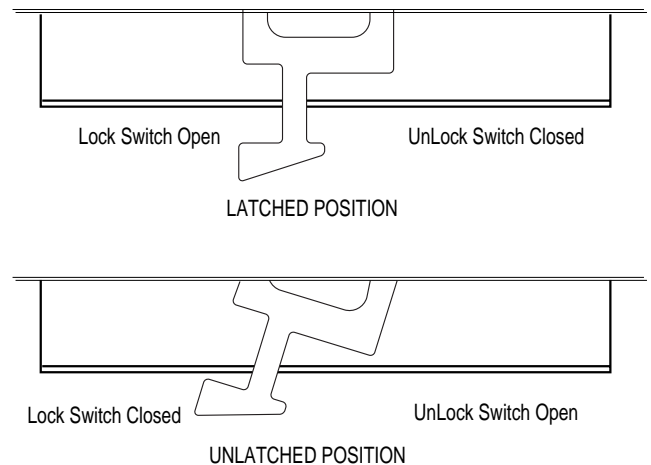

## THE HIDDEN BAKE ELEMENT

Refer to Pages 85 and 86 to access the bake element.

1. With no power applied, remove the wires from the terminals of the hidden bake element.
2. Set the ohmmeter to the R x 1 scale.
3. Touch the ohmmeter leads to the bake element terminals. The meter should indicate 24  $\Omega$ .
4. If the reading is not correct, remove and replace the bake element.

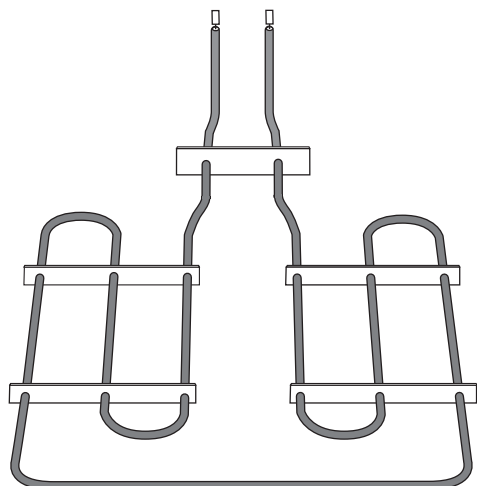

## THE BROIL ELEMENT

Refer to Page 30 to access the broil element.

1. With no power applied, remove the wires from the terminals of the broil element.
2. Set the ohmmeter to the R x 1 scale.
3. Touch the ohmmeter leads to the broil element terminals. The meter should indicate 15  $\Omega$ .
4. If the reading is not correct, remove and replace the broil element.

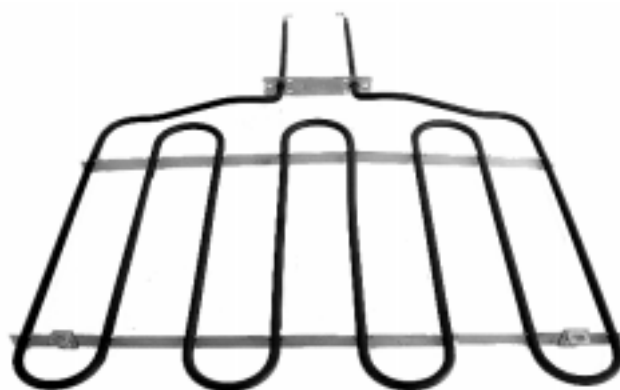

## THE CONVECTION BAKE ELEMENT

Refer to Page 88 to access the convection bake element.

1. With no power applied, remove the wires from the terminals of the convection bake element.
2. Set the ohmmeter to the R x 1 scale.
3. Touch the ohmmeter leads to the convection bake element terminals. The meter should indicate 18  $\Omega$ .
4. If the reading is not correct, remove and replace the convection bake element.



## THE HI-TEMP CUTOUT

The hi-temp cutout contacts open at or above 350°F  $\pm 8^\circ$ , and are manually reset by pressing the reset button.

Refer to Page 93 to access the hi-temp cutout.

1. With no power applied, remove the wires from the terminals of the hi-temp cutout.
2. Set the ohmmeter to the R x 1 scale.
3. Touch the ohmmeter leads to the terminals. The meter should indicate continuity.
4. If the reading is not correct, remove and replace the hi-temp cutout.

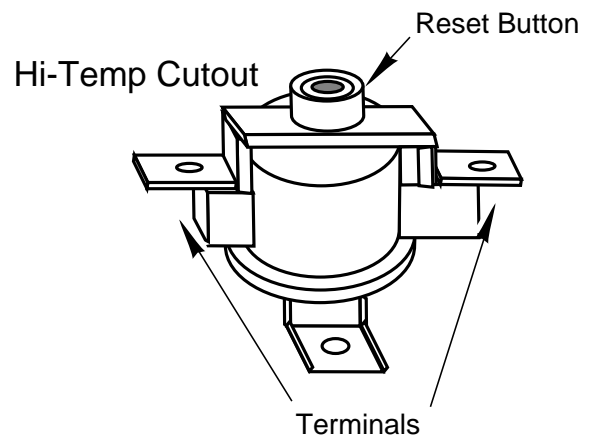

## Fault Codes

CODE	FAULT DETECTION
F10	Power board incompatibility
F11	Communication error with power board
F12	Vcc lift-off (power board)
F13	Power board not calibrated
F14	Display board EEPROM error
F19	Misc. power board error
F20	Upper oven cancel key shorted high
F21	Lower oven cancel key shorted high
F22	Upper oven cancel key shorted low
F23	Lower oven cancel key shorted low
F24	Key stuck
F25	Multiple keys stuck
F30	Upper oven sensor shorted
F31	Upper oven sensor open
F32	Upper oven over temperature while cleaning
F33	Upper oven over temperature while cooking
F34	Upper oven cooling fan not operating
F40	Upper meat probe shorted
F50	Upper door signal shorted low
F51	Upper door stuck locked
F52	Upper oven door position error (locked and open)
F53	Upper door stuck locked
F54	Upper latch input shorted
F60	Lower oven sensor shorted
F61	Lower oven sensor open
F62	Lower oven over temperature while cleaning
F63	Lower oven over temperature while cooking
F64	Lower oven cooling fan not operating
F70	Lower meat probe shorted
F80	Lower door signal shorted low
F81	Lower door stuck locked
F82	Lower oven door position error (locked and open)
F83	Lower door stuck locked
F84	Lower latch input shorted

# CM301 ELECTRONIC OVEN CONTROL WIRING

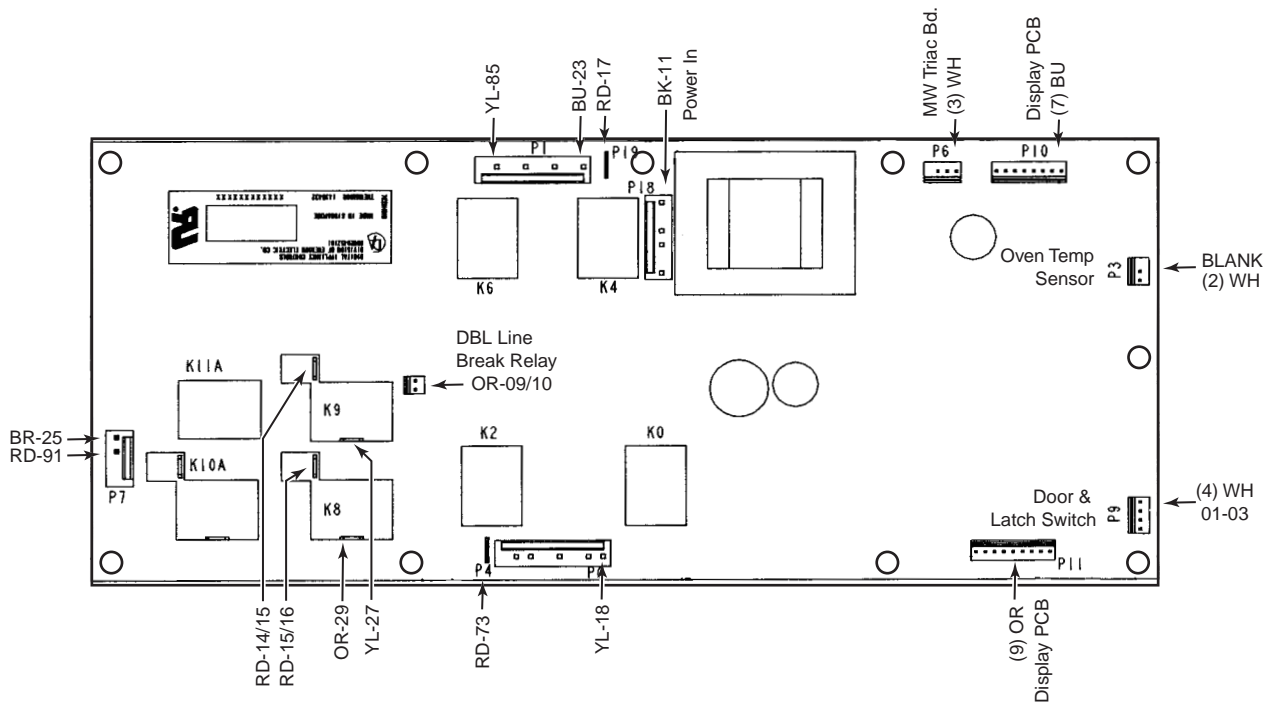

# CM302 ELECTRONIC OVEN CONTROL WIRING

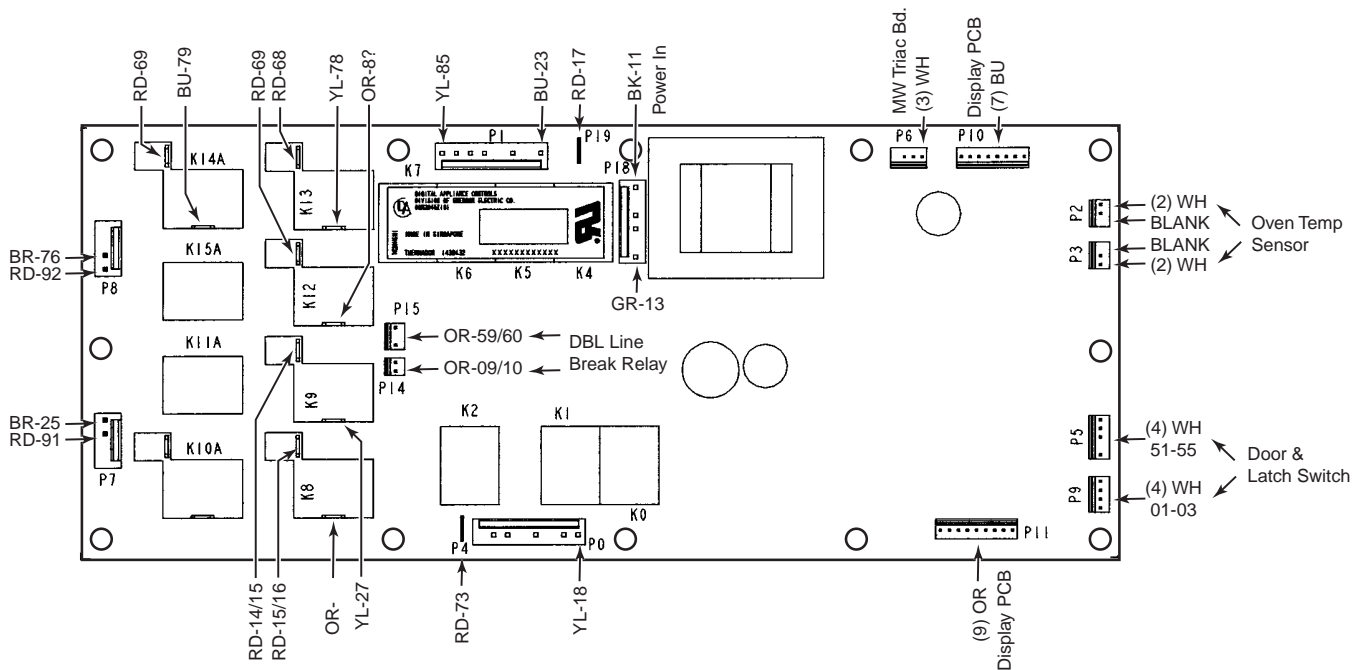

***Thermador***<sup>®</sup>

5551 McFadden Avenue, Huntington Beach, CA 92649 • 800/735-4328  
ECO91450 • 94-30-006B • ©BSH Home Appliances Corp. 2000 • Litho U.S.A. 8/00