

Section 7 - Troubleshooting Guide



IMPORTANT

- While this troubleshooting guide provides information to aid in troubleshooting problems with the range, it does not contain information on every possible type of failure.
- See *Appendix A* to determine when elements and convection fan should be on or off.

Control Panel Error Codes

The error codes below apply to both models ER36D and ER48D.

General Error Codes

The following codes give a general indication of the location of problems detected by the control panel controller board. They are usually followed by another, more specific error code (see below).

ERROR CODE	GENERAL LOCATION
F1	INTERNAL
F2	COMMUNICATION BETWEEN CONTROL PANEL AND RELAY BOARD
F3	EXTERNAL
F9	DOOR LOCK

Specific Error Codes

ERROR CODE	POSSIBLE CAUSES	POSSIBLE SOLUTIONS
F10	Shorted element relay.	Replace power board.
	Intermittent temperature sensor or loose sensor wiring.	Tighten sensor connections for replace temperature sensor.
F11	Shorted key (button) on keypad membrane.	Replace keypad membrane.
F13	Control panel failure.	Replace power board.
F14	Defective power board.	Replace power board.
F15	Defective power board.	Replace power board.
F20	Data cable between relay board and control panel loose or defective.	Tighten connections, replace if necessary.
	Defective control panel circuit board.	Replace control panel circuit board.
F30	Shorted temperature sensor.	Replace sensor.
	Shorted temperature sensor wiring.	Repair sensor wiring.
F31	Open temperature sensor.	Replace sensor.
	Open temperature sensor wiring.	Replace sensor wiring.
F32	Data cable between relay board and control panel loose or defective.	Tighten connections, replace if necessary.
	Defective membrane.	Replace membrane.
F90	Cables to door latch loose or defective.	Tighten connections or repair cable.
	Defective door latch assembly.	Replace door latch assembly.
F95	Defective power board.	Replace power board.

DACOR RANGE SERVICE MANUAL

Basic Troubleshooting Instructions

1. If the range does not function properly, check for obvious problems first, such as the main power switch being turned off, or the control panel being locked.
2. If the problem is not immediately obvious, use the *Performance Tests* in *Appendix B* and consult the *Troubleshooting Chart* on the following pages to help locate the problem.

Troubleshooting Chart - Oven

<u>PROBLEM</u>	<u>POSSIBLE CAUSES</u>	<u>WHAT TO CHECK</u>
Nothing works, no power to the range, control panel display is dark, burners do not spark, burner knobs don't light when turned on.	Range not connected to electrical power.	<ul style="list-style-type: none"> • Conduit or appliance wire connection.
	Power to range is off.	<ul style="list-style-type: none"> • Tripped circuit breaker or blown fuse.
	Power outage.	<ul style="list-style-type: none"> • Contact power company.
	Wiring problems.	<ul style="list-style-type: none"> • Check wiring harness.
Oven will not heat. Cooktop works OK. Control panel lit. Oven controller beeps when keys are pressed.	Oven setting not correct.	<ul style="list-style-type: none"> • Press CANCEL/SECURE, then follow instructions in <i>Operating the Oven</i> section of this manual.
	Oven set for delay timed cooking.	<ul style="list-style-type: none"> • Oven will turn on automatically at preset time. Press CANCEL/SECURE to return to normal operation.
	Attempting to broil with meat probe connected.	<ul style="list-style-type: none"> • Broil and convection broil settings will not work when meat probe is connected. Disconnect meat probe.
	Power board problems.	<ul style="list-style-type: none"> • Power board wiring. • Power board.
	Bad heating element.	<ul style="list-style-type: none"> • Check <i>Cycling Chart</i> (Appendix A) to determine elements used during the mode that is not working. Check continuity.
Oven does not heat, display is lit. Cooktop works OK. Control panel does <u>not</u> beep when keys are pressed.	High limit switch tripped or defective.	<ul style="list-style-type: none"> • Wires to high limit switch. • High limit switch.
	Power board problems.	<ul style="list-style-type: none"> • Power board.
	Control panel locked-up.	<ul style="list-style-type: none"> • Cycle power. Check range to see if normal operation resumes.
Oven does not heat, display is <u>not</u> lit. Cooktop works OK. Control panel does not beep when keys are pressed.	Control panel problems.	<ul style="list-style-type: none"> • Cable from power board to oven controller board. • Oven controller board. • Cable from oven controller board to keypad membrane. • Keypad membrane.
	Power board problems.	<ul style="list-style-type: none"> • Wiring to power board • Power board
	Control panel locked-up.	<ul style="list-style-type: none"> • Cycle power. Check range to see if normal operation resumes.
	Control panel problems.	<ul style="list-style-type: none"> • Cable from power board to oven controller board. • Oven controller board. • Cable from oven controller board to keypad membrane. • Keypad membrane.

SECTION 7 - TROUBLESHOOTING GUIDE

Troubleshooting Chart - Oven (continued)

PROBLEM	POSSIBLE CAUSES	WHAT TO CHECK
Time on display not correct.	Time of day not set.	<ul style="list-style-type: none"> • Set time.
	Power failure or power was turned off.	<ul style="list-style-type: none"> • Reset time.
	Control panel problems.	<ul style="list-style-type: none"> • Oven controller board.
Time flashes on display.	Power failure or power was turned off.	<ul style="list-style-type: none"> • Reset time.
	Control panel problems.	<ul style="list-style-type: none"> • Cable from power board to oven controller board. • Oven controller board. • Cable from oven controller board to keypad membrane. • Keypad membrane.
Oven does not self-clean. Display is lit. Oven controller beeps when keys are pressed. Cooktop works OK.	Door not shut tightly.	<ul style="list-style-type: none"> • Check for obstructions. Close door tightly.
	Oven set for delay timed cleaning.	<ul style="list-style-type: none"> • Oven will start to self-clean at preset time. Press CANCEL/SECURE to return to normal operation.
	Model ER48D only: Other oven is on or self-cleaning.	<ul style="list-style-type: none"> • Due to power consumption on model ER48D, one oven cannot self-clean while the other is in use or self-cleaning. Turn off other oven.
	Oven not set properly.	<ul style="list-style-type: none"> • Follow instructions in <i>Cleaning and Maintenance</i> section.
	Meat probe connected.	<ul style="list-style-type: none"> • Oven will not start self-clean cycle when meat probe is connected. Disconnect and remove meat probe.
	Door latch problems.	<ul style="list-style-type: none"> • Door latch wiring. • Door latch and switches.
	High limit switch tripped or defective.	<ul style="list-style-type: none"> • Wires to high limit switch. • High limit switch.
	Power board problems.	<ul style="list-style-type: none"> • Power board wiring. • Power board.
Oven lights will not work. Oven heats normally and cooktop works OK.	Control panel problems.	<ul style="list-style-type: none"> • Oven controller board. • Cable from oven controller board to keypad membrane. • Keypad membrane (self-clean key).
	Light bulbs burned out.	<ul style="list-style-type: none"> • Replace light bulbs. See <i>Cleaning and Maintenance</i> section.
	Oven in self-clean mode.	<ul style="list-style-type: none"> • Lights do not work when oven is in self-clean mode.
	Light fixture/wiring problems.	<ul style="list-style-type: none"> • Light wiring harness. • Light fixture.
	Light transformer.	<ul style="list-style-type: none"> • Wiring between transformer and power board. • Transformer.
Power board problems.	Power board problems.	<ul style="list-style-type: none"> • Wiring to power board. • Power board.
	Control panel problems.	<ul style="list-style-type: none"> • Oven controller board. • Cable from oven controller board to keypad membrane. • Keypad membrane.

DACOR RANGE SERVICE MANUAL

Troubleshooting Chart - Oven (continued)

PROBLEM	POSSIBLE CAUSES	WHAT TO CHECK
Foods over or under cook.	Incorrect cooking time or temperature.	<ul style="list-style-type: none"> Follow instructions in <i>Operating Instructions</i> section.
	Items not being cooked on rack level that will provide best results.	<ul style="list-style-type: none"> See <i>Understanding the Various Cooking Modes</i> section.
	Food placed in oven during pre-heat.	<ul style="list-style-type: none"> Make sure pre-heat indicator on display is off before putting food in oven (does not apply to broil modes).
	Oven set to incorrect temperature scale.	<ul style="list-style-type: none"> See <i>Setting the Temperature Scale</i> section.
	Relay stuck closed on power board.	<ul style="list-style-type: none"> Power board.
	Defective temperature sensor.	<ul style="list-style-type: none"> Temperature sensor.
	Elements not wired correctly.	<ul style="list-style-type: none"> Check for correct element wiring.
Cooling fan continues to run after oven is turned off. Shuts off after extended period of time.	Normal operation.	<ul style="list-style-type: none"> The cooling fan may run for a while after the oven is turned off, until the internal parts have cooled.
Cooling fan runs continuously after oven is off and does not shut off after an extended period of time.	Power board problems.	<ul style="list-style-type: none"> Power board.
	Defective temperature sensor.	<ul style="list-style-type: none"> Temperature sensor.
	Control panel problems.	<ul style="list-style-type: none"> Cable from power board to oven controller board. Oven controller board.
Oven door will not open.	Oven is set to self-clean.	<ul style="list-style-type: none"> Check display. If "LOCK" appears on display oven door cannot be opened. Wait for oven to complete self-clean or press CANCEL/SECURE. Door will unlock once oven has cooled.
	Door latch problems.	<ul style="list-style-type: none"> Door latch wiring. Door latch and switches.
	Power board problems.	<ul style="list-style-type: none"> Power board.
Meat probe does not work.	Meat probe not plugged in.	<ul style="list-style-type: none"> Make sure meat probe is plugged into meat probe connector.
	Meat probe defective.	<ul style="list-style-type: none"> Check meat probe continuity.
	Meat probe connector problem.	<ul style="list-style-type: none"> Wiring from meat probe to power board. Power board.

SECTION 7 - TROUBLESHOOTING GUIDE

Troubleshooting Chart - Cooktop

PROBLEM	POSSIBLE CAUSES	WHAT TO CHECK
Igniters do not spark. Control panel is dark.	Range not connected to electrical power.	<ul style="list-style-type: none"> Have electrician connect range to properly wired electrical connection.
	Power to range is off.	<ul style="list-style-type: none"> Turn power on at junction box. Check for tripped circuit breaker or blown fuse.
	Power outage.	<ul style="list-style-type: none"> Contact power company.
Igniters do not spark. Control panel is lit.	Wet or dirty igniter.	<ul style="list-style-type: none"> Clean according to <i>Cleaning and Maintenance</i> section.
	Spark module problems.	<ul style="list-style-type: none"> Wiring between terminal blocks below access panel and spark module (including switches mounted to the valves). Wiring between spark module and igniter. Spark module.
No flame.	Igniter(s) not working (no clicking sound).	<ul style="list-style-type: none"> See igniters do not spark above.
	Wet or dirty igniter.	<ul style="list-style-type: none"> Clean according to <i>Cleaning and Maintenance</i> section.
	Gas is turned off.	<ul style="list-style-type: none"> Make sure the gas supply valve is in the on position.
	Gas supply interrupted.	<ul style="list-style-type: none"> Contact gas company.
	Gas supply pressure too low.	<ul style="list-style-type: none"> Make sure gas supply to building meets the <i>Gas Supply Requirements</i> in the installation section.
	Defective regulator.	<ul style="list-style-type: none"> Gas supply regulator.
Flame yellow at tips.	LPG gas supply.	<ul style="list-style-type: none"> Slightly yellow tips are normal for range equipped for use with LPG.
Large, erratic, or yellow flame.	Dirty burner assembly.	<ul style="list-style-type: none"> Make sure burner bases, burner heads, burner rings, and burner caps are free of grease and grime. See <i>Cleaning and Maintenance</i>. On stack burners, make sure the main orifice in the bottom of the burner base is not plugged up.
	Burner ring or burner cap not properly positioned.	<ul style="list-style-type: none"> Make sure burner is assembled according to the <i>Installation Instructions</i> section.
	Range not equipped for correct altitude or gas type (natural gas or LPG).	<ul style="list-style-type: none"> Determine if range is properly equipped for type of gas being used and for the correct altitude range. See <i>Model Identification</i> section.
	Crown burner venturi out of adjustment.	<ul style="list-style-type: none"> Check venturi opening. See <i>Component Repair</i> section.
	Low gas pressure.	<ul style="list-style-type: none"> Make sure gas supply to building meets the <i>Gas Supply Requirements</i> in the installation section.
	Defective regulator.	<ul style="list-style-type: none"> Gas supply regulator.

Troubleshooting Chart - Cooktop

<u>PROBLEM</u>	<u>POSSIBLE CAUSES</u>	<u>WHAT TO CHECK</u>
Igniter continues to spark (click) after flame ignites.	Burner is cold.	<ul style="list-style-type: none">• Burners may continue to spark for up to 60 seconds when cold and set to low. See <i>Operating the Cooktop</i> section for more information on how to minimize.
	Flame distorted by air draft.	<ul style="list-style-type: none">• Minimize any air drafts around the range. Close nearby windows.
	Wet or dirty igniter.	<ul style="list-style-type: none">• Clean according to <i>Cleaning and Maintenance</i> section.
	Burner ring or burner cap is dirty.	<ul style="list-style-type: none">• Clean according to <i>Cleaning and Maintenance</i> section.
	Burner ring or burner cap not properly positioned.	<ul style="list-style-type: none">• Make sure burner is assembled according to the <i>Installation Instructions</i> section.
	Improper electrical polarity.	<ul style="list-style-type: none">• Electrical wiring reversed. See <i>Electrical Connection</i> in <i>Installation Instructions</i> section.
Flame goes out at low setting.	Air intake holes obstructed.	<ul style="list-style-type: none">• Check to make sure air holes above knobs are not blocked.
	Low gas pressure.	<ul style="list-style-type: none">• Make sure gas supply to building meets the <i>Gas Supply Requirements</i> in the installation section.
Burner knob does not light.	LED harness problems.	<ul style="list-style-type: none">• LED wiring harness connection.• LED wiring harness wires open.
	LED defective.	<ul style="list-style-type: none">• LED continuity.

Accessing Software Version Information

To access to read the software versions loaded on the various printed circuit boards:

1. Disconnect power to the range for 20 seconds, then reconnect.
2. Within the first 30 seconds after power up, press and hold the BAKE and BROIL keys for at least 6-10 seconds to enter diagnostic mode.
3. Press START to read the EEPROM version on the control board.
4. Press PROBE to read the FLASH version on the control board.
5. Press SELF-CLEAN to read the software version on the power board.
6. Press CANCEL/SECURE twice to exit diagnostic mode.

Section 8 - Range Disassembly

DANGER

- Turn off electrical power at the main power supply and the gas supply at the gas supply valve before servicing the range. Failure to turn off electrical power and the gas supply to the range will result in a electric shock and explosion hazard.

Door Removal

WARNING

- Do not attempt to disengage the hinge locks on the door while it is removed from the oven. The hinge springs could release, causing personal injury.
 - Do not lift or carry the oven door by the door handle.
- Open the oven door completely.
 - Pull the hinge locks forward on both hinges, until they stop.

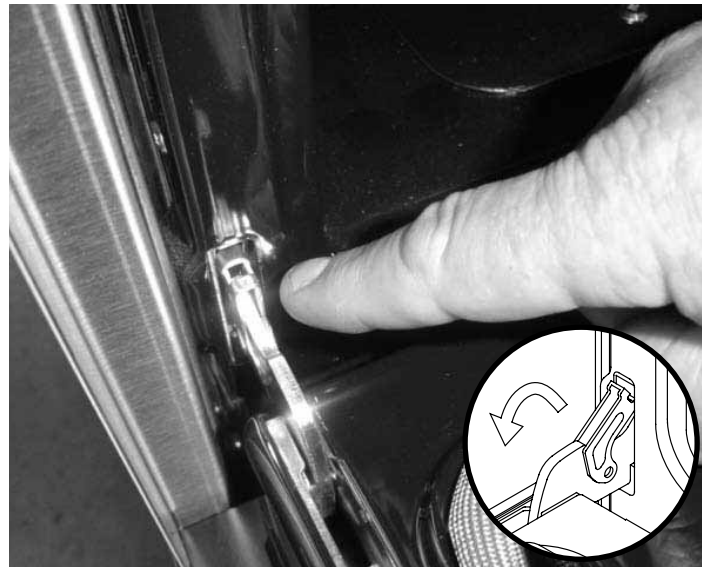

- Raise the door so that it is at a 15° angle from the front of the oven. Hold the door with one hand on each side. Lift the door up and out.



Door Installation

WARNING

- Be sure that the notch on the bottom of each hinge rests on top of the lower lip of each hinge receptacle before attempting to open the oven door. Failure to do so may cause the door to fall off its hinges, resulting in personal injury or damage to the door.
- Rotate the hinge locks toward the front of the range immediately after installation of the door. Failure to do so may cause the door to fall off its hinges, resulting in personal injury or damage to the door.

- Grasp the oven door on opposite sides and hold it at a 15° angle from the front of the oven. Slide the hinges **A** into the hinge openings **B**, resting the bottom of the hinge arms **C** on the lower lip **D** of the hinge receptacles. Continue to hold the door at a 15° angle with one hand while pushing in on each of the bottom corners of the door. Push until the notch **E** on the bottom of each hinge slips over the lower lip **D** of each hinge receptacle.
- Lower the door to the fully opened position.
- Rotate both hinge locks toward the oven.
- Open and close the door completely to ensure that it is properly installed.

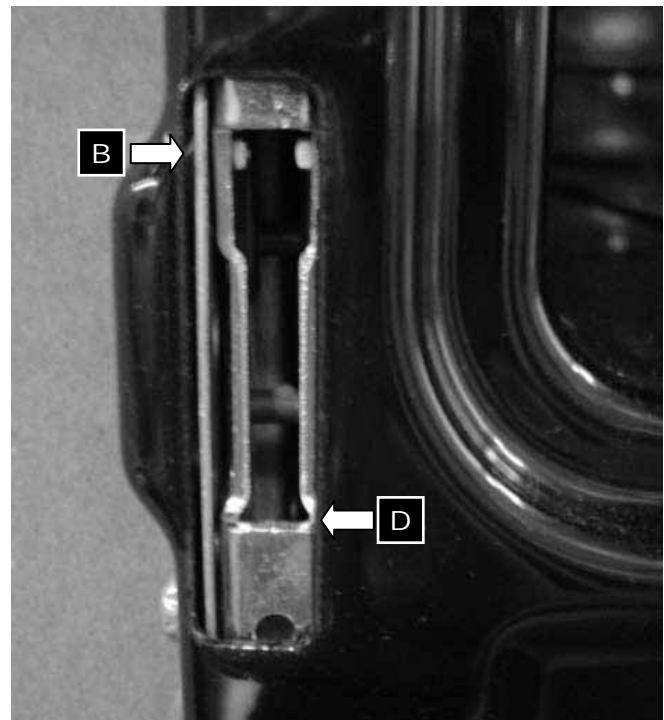
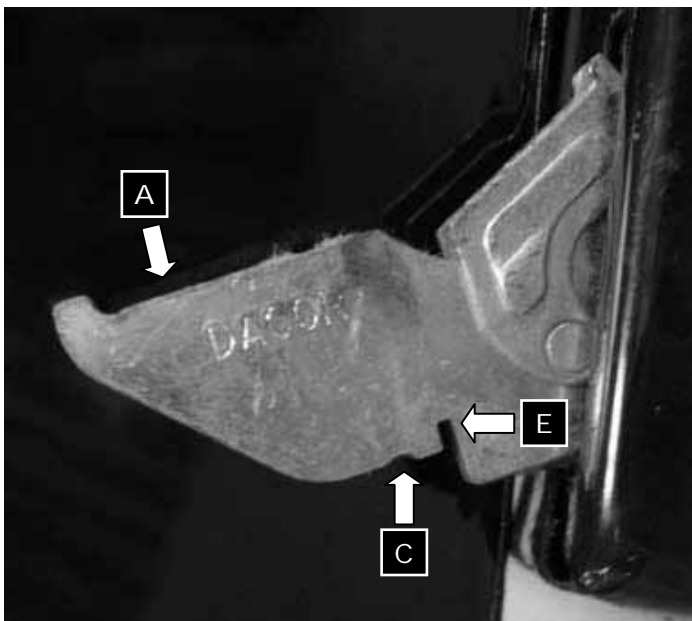

SECTION 8 - RANGE DISASSEMBLY

Removing the Back Panel

- Turn off the gas supply at the gas supply valve and power to the range at the junction or fuse box.
- Pull the range out from the wall or cabinet.
- Remove the grates, the burner caps, burner rings, and crown burner heads from the cooktop.
- If the range is equipped with a 24" backguard **F**, remove the eight (8) backguard bracket hex screws **G**. They are accessed through the 8 holes **H** on the back of the backguard.

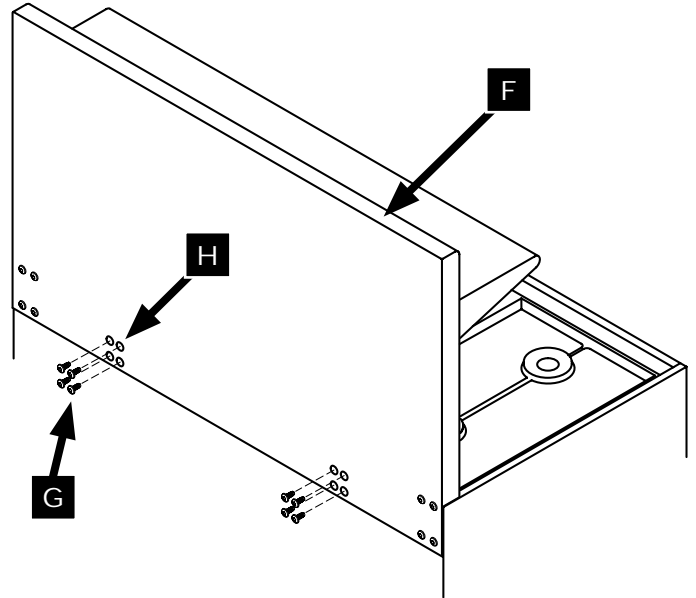

- Remove the five (5) screws **I** on the front of the island trim/backguard **J**, above the spill trays **K**.

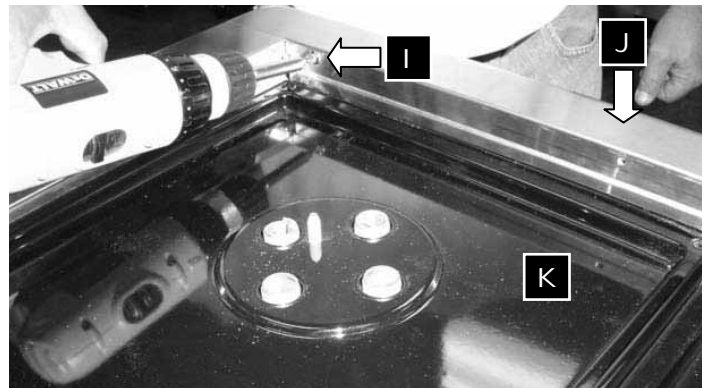

- Remove the eight (8) screws on the back side of the island trim/backguard, four (4) on each side of the range.



Removing the Back Panel (continued)

- Pull the island trim/backguard **J** up and off the range.
- Remove the stainless steel spill tray trim piece **L**.

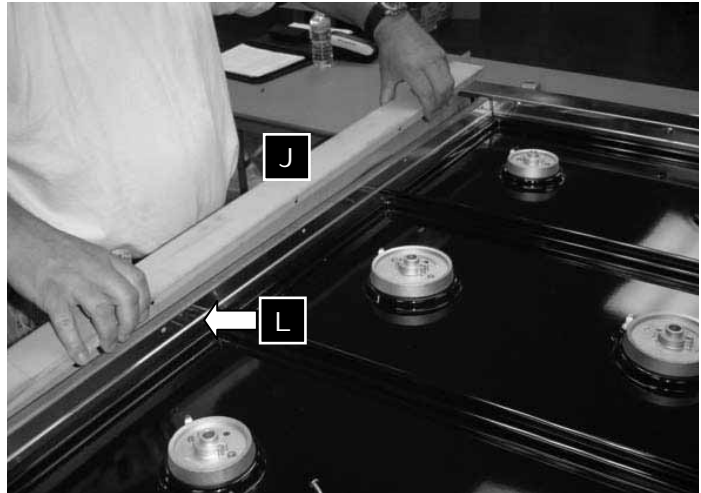

- Remove the electrical access panel cover **N** by removing the two (2) screws **M** that hold it in place.
- Remove the two (2) screws **O** on the sides of the electrical access panel. It is not necessary to remove the gas regulator access panel cover **P**.

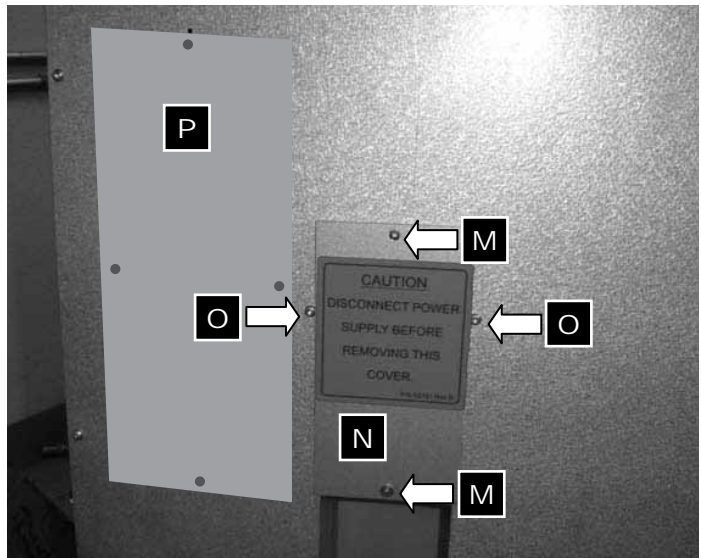

- Remove all of the remaining screws from the back panel and pull it off.



SECTION 8 - RANGE DISASSEMBLY

Removing the Side Panel(s)

- Turn off the gas supply at the supply valve and power to the range at the junction or fuse box.
- Pull the range out from the wall or cabinet
- Remove all of the screws from the edge of the back panel **A** on the same side of the range as the side panel being removed.

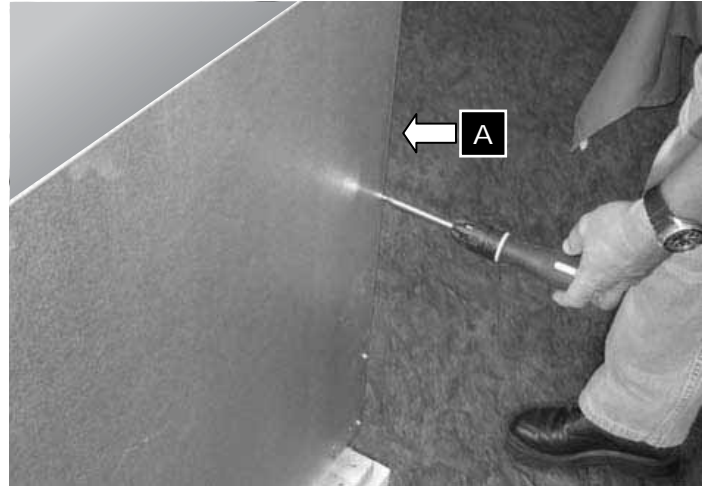

- Loosen the end cap set screws **B** through the access holes **C** on the bottom of the front panel lip **D**.

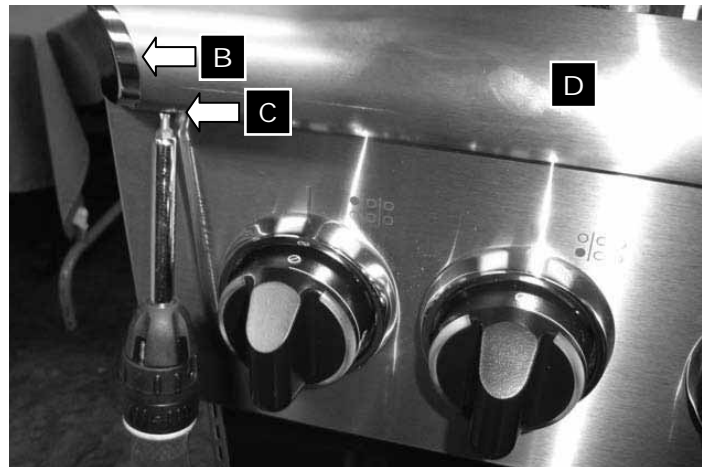

- Remove the end cap.



Removing the Side Panel(s) (continued)

- Remove the side panel screw inside the front panel lip.



- Remove the grates, the burner caps, burner rings, and crown burner heads from the cooktop.
- Remove the screws above the spill tray that hold the side panel in place.



- Lift the side panel off of the range.



Removing the Spill Trays

CAUTION

- Take care when disassembling the spill tray. Many of the spill tray components are porcelain coated and can chip.

- Turn off the gas supply at the supply valve and power to the range at the junction or fuse box.
- Remove the grates, the burner caps, burner rings, and crown burner heads from the cooktop.
- Remove the spill tray trim screws, located above the spill trays **E**, from the back, front, and side panels.
- Slip all four (4) spill tray trim pieces **F** that were held in place by the screws out of the side, front, and back panels **G**.
- Use the thread ring removal tool **H** (Dacor part# 101539, included with range, see page 3-6 for location) to remove all four (4) thread rings **I** from the crown burner bases (eight [8] thread rings total).

NOTE

- Dacor recommends using anti-seize grease on the thread rings during reassembly. Doing so will make future disassembly easier.

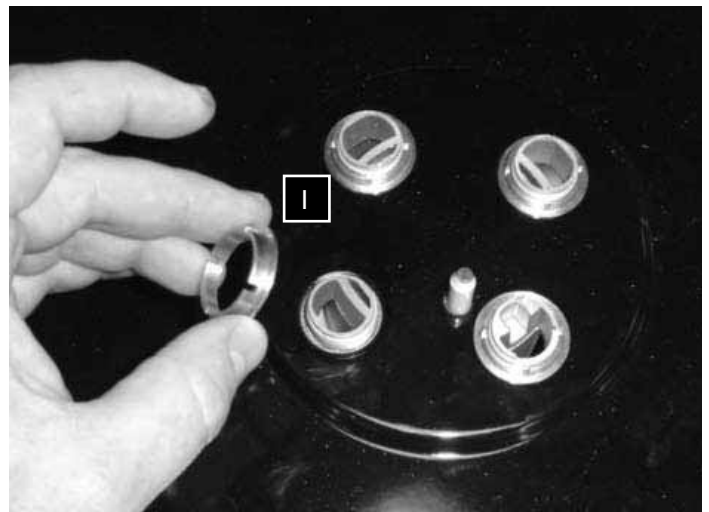
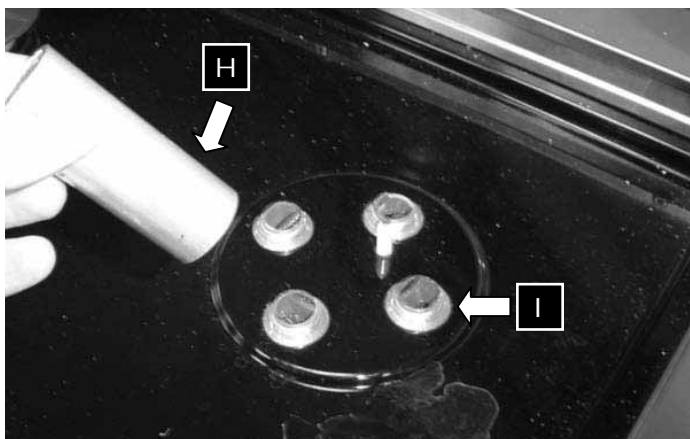
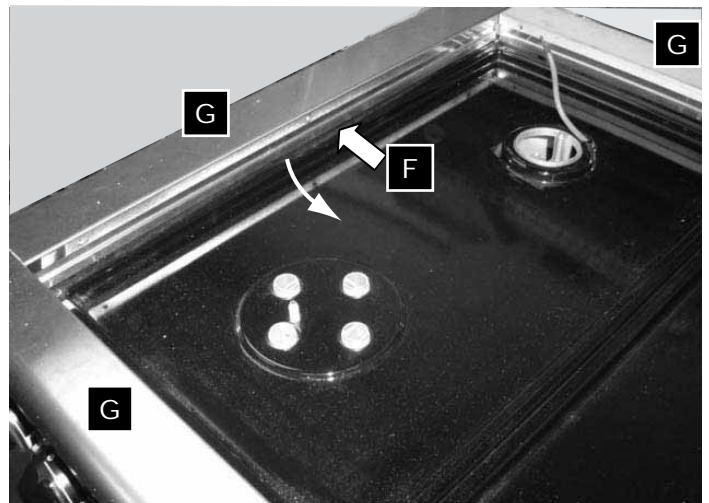
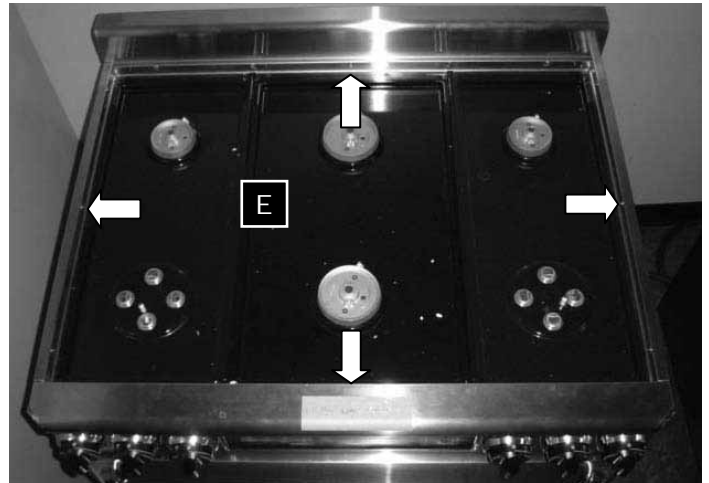

Removing the Spill Trays (continued)

- Remove the screws from the stack burner heads **H** (eight [8] screws total).

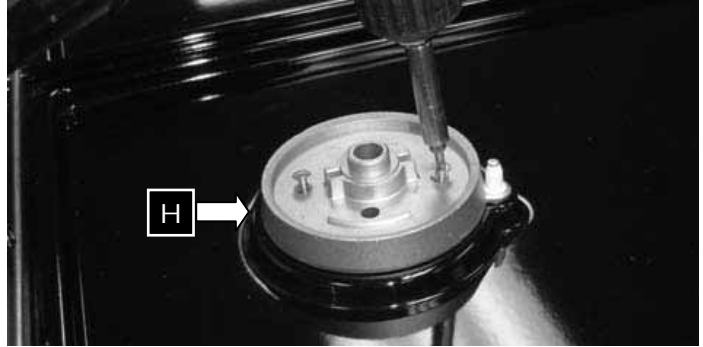

- Remove each of the stack burner heads. When removing the head, disconnect the igniter wire from each one.



- Gently lift up on the back of one of the porcelain trim pieces **I** where the spill trays **J** come together. Pull it toward the back of the range and out of the stainless steel trim piece above the front of the spill tray. Be careful not to chip the porcelain.
- Repeat for the remaining porcelain trim piece.

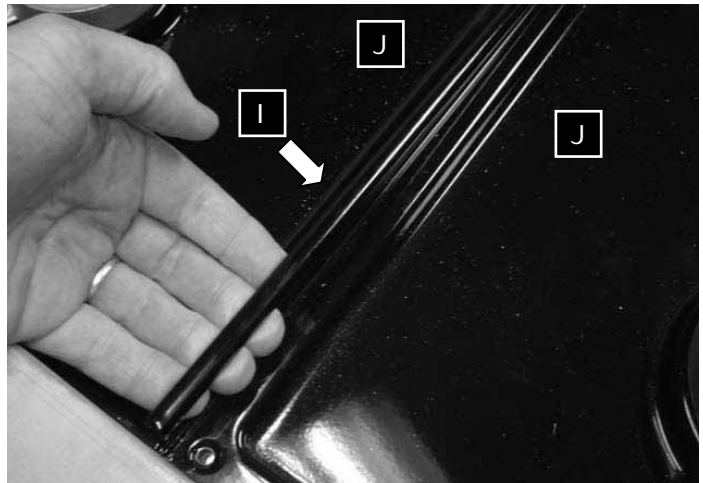

- To remove the spill trays, pull up on the back of each spill tray and slip it out of the stainless steel trim piece toward the front of the range. Be careful not to chip the porcelain.



Section 9 - Component Repair

DANGER

- Turn off electrical power at the main power supply and the gas supply at the supply valve before servicing the range. Failure to turn off electrical power and the gas supply to the range will result in a electric shock and explosion hazard.

Door Component Repair

WARNING

- Do not attempt to disengage the hinge locks on the door while it is removed from the oven. The hinge springs could release, causing personal injury.
- Do not lift or carry the oven door by the door handle.

Door Gasket (seal)

- Remove the oven door. See the *Door Removal* section on page 8-1.
- Lay the door on a flat, padded surface with the door gasket **A** facing up.
- Remove the gasket by grasping sections of it and pulling up.
- Insert the self-locking tabs on the replacement gasket into the holes on the oven door. Check to make sure that all of the self-locking tabs are firmly in place by pulling gently on the gasket.
- Reinstall the oven door. See the *Door Installation* section on page 8-2.



Door Handle (ER48D)

- Remove the oven door. See the *Door Removal* section on page 8-1.
- Lay the door on a flat, padded surface with the door gasket facing up.
- Remove the two (2) screws **B** in the top corners of the door.
- Grasp the door with one hand and pull up. Pull the door handle out from underneath.
- To reinstall the door handle, grasp the door with one hand and pull up. Hold the handle in position on the front. Lower the door onto the padded surface.
- Replace the two (2) screws in the top corners of the door and tighten into place. Do not over-tighten the screws. The front door glass could crack.
- Reinstall the oven door. See the *Door Installation* section on page 8-2.



Door Handle (ER36D)

- Remove the oven door. See the *Door Removal* section on page 8-1.
- Lay the door on a flat, padded surface with the door gasket facing up.
- Remove the two (2) door handle screw plugs **X**. The door handle mounting screws are located below the plugs.
- Remove the two (2) door handle screws **Y**. Do not remove the door liner screws **B**.
- Grasp the door with one hand and pull up. Pull the door handle out from underneath.
- To reinstall the door handle, grasp the door with one hand and pull up. Hold the handle in position on the front. Lower the door onto the padded surface.
- Replace the two (2) screws in the top corners of the door and tighten into place. Do not over-tighten the screws. The front door glass could crack.
- Reinstall the door handle screw plugs.
- Reinstall the oven door. See the *Door Installation* section on page 8-2.

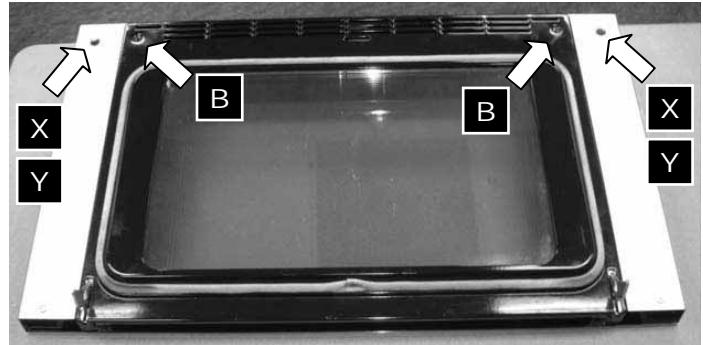

Door Component Repair (continued)

Front Door Glass Assembly



WARNING

- To prevent personal injury, use gloves when handling glass components that are broken or shattered.

- Remove the oven door. See the *Door Removal* section on page 8-1.
- Lay the door, handle down, on a flat, padded surface with the door gasket facing up.
- Remove the two (2) screws **B** in the top corners of the door.
- On ER48D Only: Grasp the top end of the door with one hand and pull up. Pull the door handle out from underneath.
- Grasp the top of the door with both hands and turn it over on the padded surface so that the door gasket faces up.
- Remove the two (2) inner screws **C** on the bottom of the door. The outer screws **D** on the bottom of the door are part of the hinge assembly. Do not remove them.

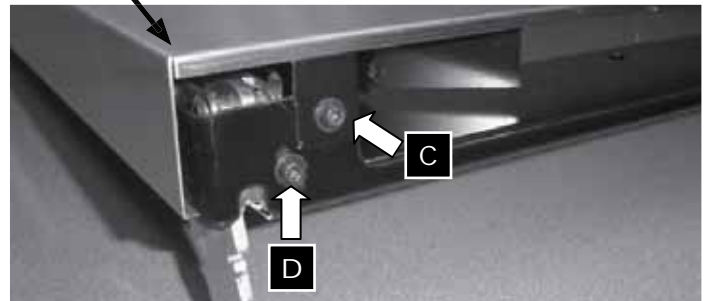

- Grab the front door glass assembly with both hands and remove it.
- On ER36D Only: Remove the two (2) door handle screw plugs **X**. The door handle mounting screws are located below the plugs (see facing page). Remove the two (2) door handle screws **Y**. Do not remove the door liner screws **B**. Assemble the door handle to the new front door glass assembly. Replace the plugs



Door Component Repair (continued)

- When putting the front door glass assembly back in place, be careful not to knock loose the door spacers which are glued to the top corners. Also, make sure the tabs **E** on the bottom rest on the outside of the door liner.
- Reinstall the screws on the bottom of the door, then grasp the top of the door with both hands and turn it over.
- On ER48D Only: Hold the top end of the door up with one hand. Position the handle under the door and lower the door on top. Replace the handle screws. Do not over-tighten.
- Reinstall the oven door. See the *Door Installation* section on page 8-2.

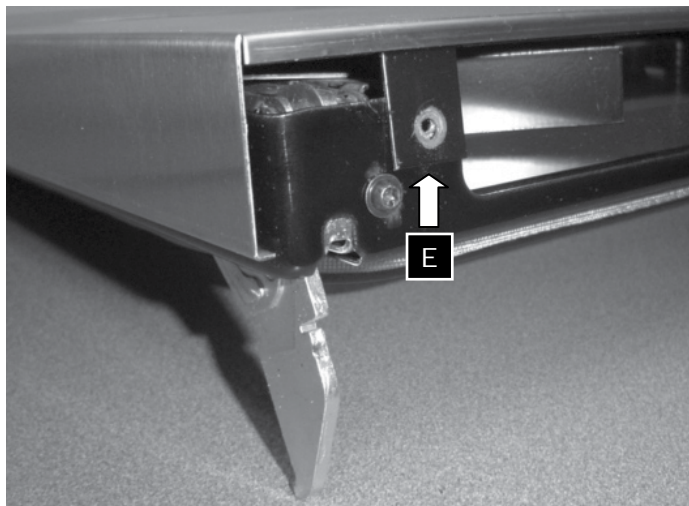

Door Hinges

- Remove the oven door. See the *Door Removal* section on page 8-1.
- Lay the door, handle down, on a flat, padded surface with the door gasket facing up.
- Remove the two (2) screws **B** in the top corners of the door.
- On ER48D Only: Grasp the top end of the door with one hand and pull up. Pull the door handle out from underneath.
- Grasp the top of the door with both hands and turn it over on the padded surface so that the door gasket faces up.
- Remove the two (2) inner screws **C** on the bottom of the door. The outer screws **D** on the bottom of the door are part of the hinge assembly. Do not remove them.

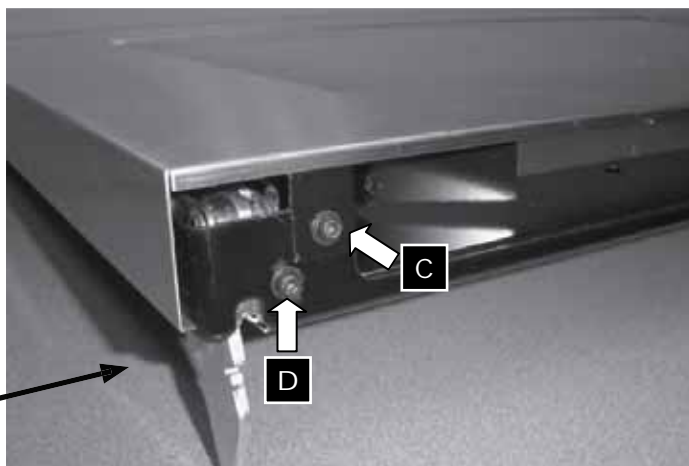

Continued...

SECTION 9 - COMPONENT REPAIR

Door Hinges (continued)

- Grab the front door glass assembly with both hands and remove it.



- Remove the two (2) hinge cover screws **F** over the hinge to be removed and pull off the hinge cover **G**.
- Remove the hinge retainer screw **H** for the hinge to be removed.

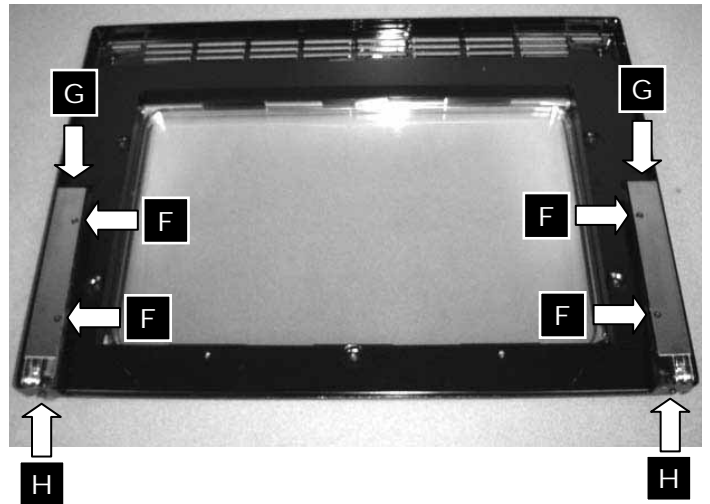

- Carefully pry up the hinge **I** up and out of the door.
- After installing the hinge, replace the hinge cover and the three (3) screws that hold the hinge assembly in place.
- Reassemble the door. When putting the front door glass assembly back in place, be careful not to knock loose the door spacers which are glued to the top corners. Also, make sure the tabs **E** on the bottom rest on the outside of the door liner.
- Reinstall the screws on the bottom of the door, then grasp the top of the door with both hands and turn it over.
- On ER48D Only: Hold the top end of the door up with one hand. Position the handle under the door and lower the door on top. Replace the handle screws. Do not over-tighten.
- Reinstall the oven door. See the *Door Installation* section on page 8-2.

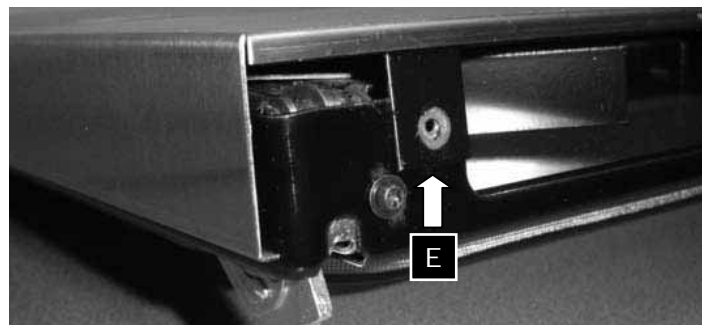
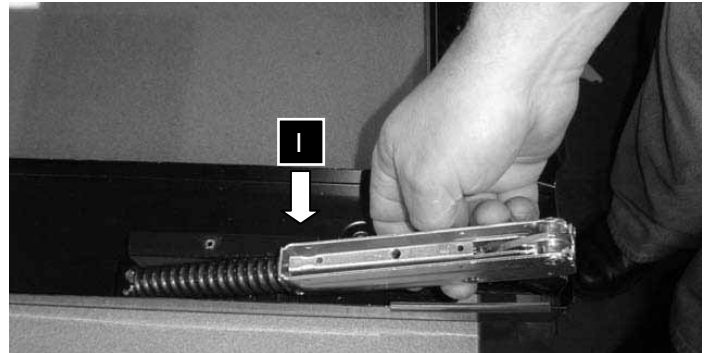

Door Component Repair (continued)

Inner Window Assembly

WARNING

- To prevent personal injury, use gloves when handling glass components that are broken or shattered.

- Remove the oven door. See the *Door Removal* section on page 8-1.
- Lay the door, handle down, on a flat, padded surface with the door gasket facing up.
- Remove the two (2) screws **B** in the top corners of the door.
- On ER48D only: Grasp the top end of the door with one hand and pull up. Pull the door handle out from underneath.
- Grasp the top of the door with both hands and turn it over on the padded surface so that the door gasket faces up.
- Remove the two (2) inner screws **C** on the bottom of the door. The outer screws **D** on the bottom of the door are part of the hinge assembly. Do not remove them.

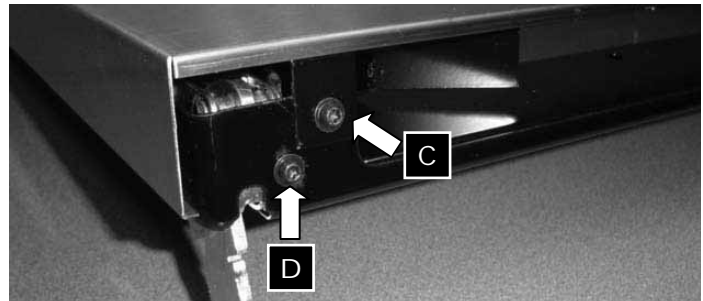

- Grab the front door glass assembly with both hands and remove it.



SECTION 9 - COMPONENT REPAIR

Inner Window Assembly (continued)

- Remove the four (4) screws **J** that hold the outer heat shield **K** in place. Lift the outer heat shield out.
- Remove the four (4) screws **L** that hold the lower outer heat shield **M** in place. Lift the lower heat shield out.
- Remove the four (4) screws **N** that hold the inner heat shield **O** in place. Lift the inner heat shield up and out toward the top of the door.
- Push the glass window assembly out of the door liner from the bottom and lift it out.

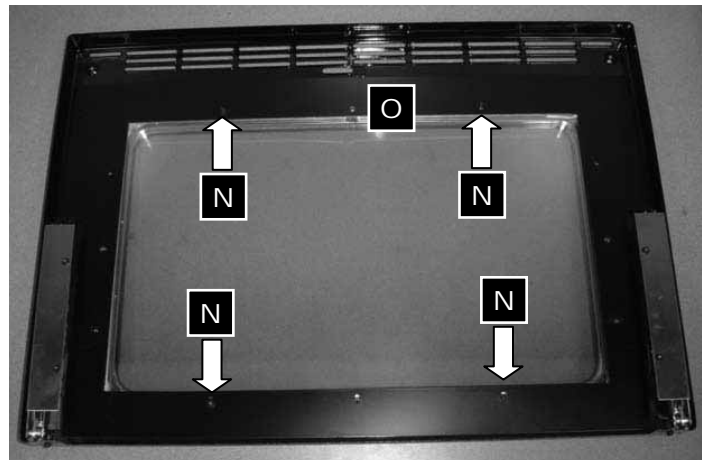
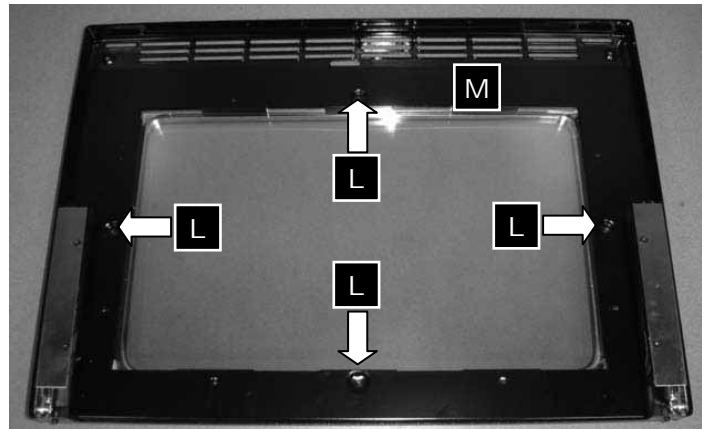
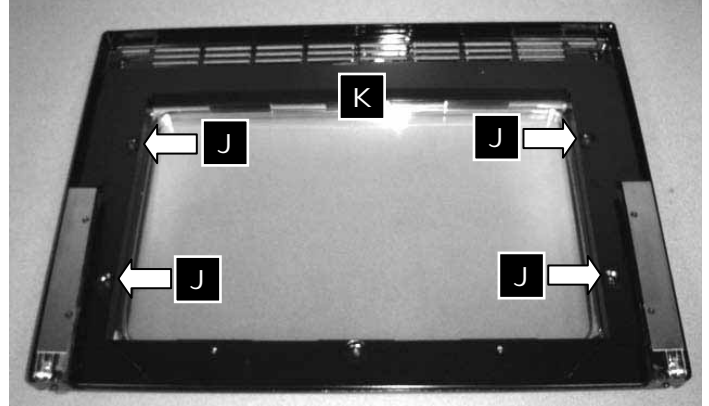

Door Component Repair (continued)

- If the inner window gasket **P** must be removed, make sure it is fit completely into the groove around the window opening before replacing the window assembly.
- Replace the window glass assembly. The seam in the metal rim around the inside of the glass must be placed toward the top of the door.
- Replace the inner heat shield and tighten into place using the existing screws.
- Replace the lower outer heat shield and tighten into place using the existing screws.
- Replace the outer heat shield and tighten into place using the existing screws.
- Reassemble the door. When putting the front door glass assembly back in place, be careful not to knock loose the door spacers which are glued to the top corners, loose. Also, make sure the tabs **E** on the bottom rest on the outside of the door liner.
- Reinstall the screws on the bottom of the door, then grasp the top of the door with both hands and turn it over.
- On ER48D only: Hold the top end of the door up with one hand. Position the handle under the door and lower the door on top. Replace the handle screws. Do not over-tighten.
- Reinstall the oven door. See the *Door Installation* section on page 8-2.

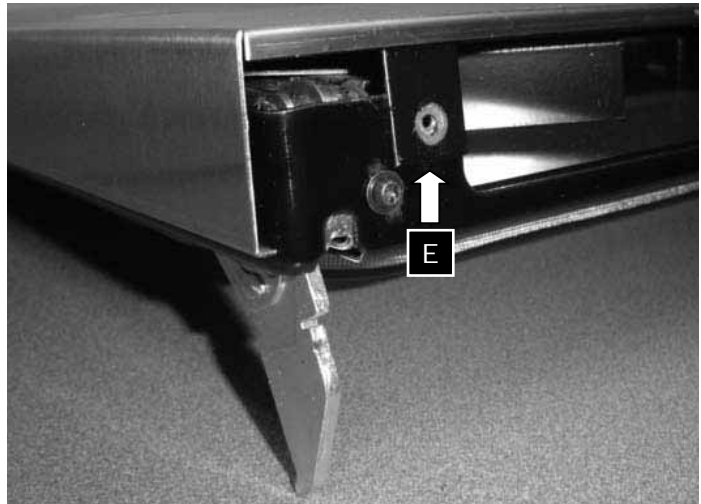

Cooktop Component Repair

General

To make repairs to the cooktop gas supply lines (flex tubes), remove the spill trays. See page 8-7 for instructions. Each burner is fed by two (2) flex tubes from the valve. The larger flex tube is the main gas supply line. It supplies gas to the main orifice on each burner. The smaller flex tube is the simmer line. It supplies gas to the simmer orifice on each burner assembly. The simmer line supplies the low volume of gas required to keep the burner lit at low flame levels.

See the schematic below for details on the routing of the various gas lines.

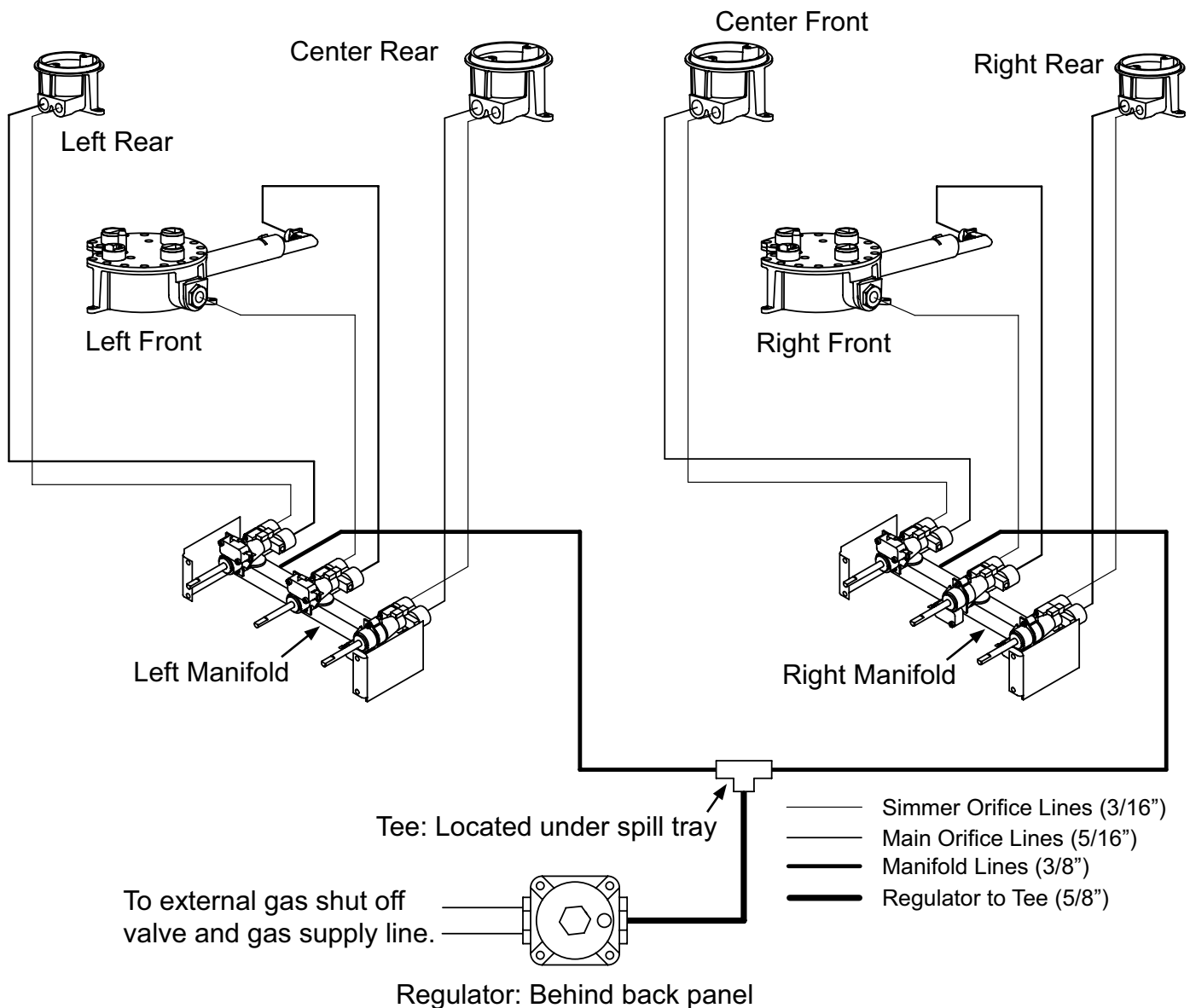

COOKTOP GAS LINES

Cooktop Component Repair (continued)

Regulator

- Turn off the gas supply at the supply valve and power to the range at the junction or fuse box.
- Pull the range out from the wall or cabinet.
- Remove the gas regulator access cover **A** from the back of the range **B**.

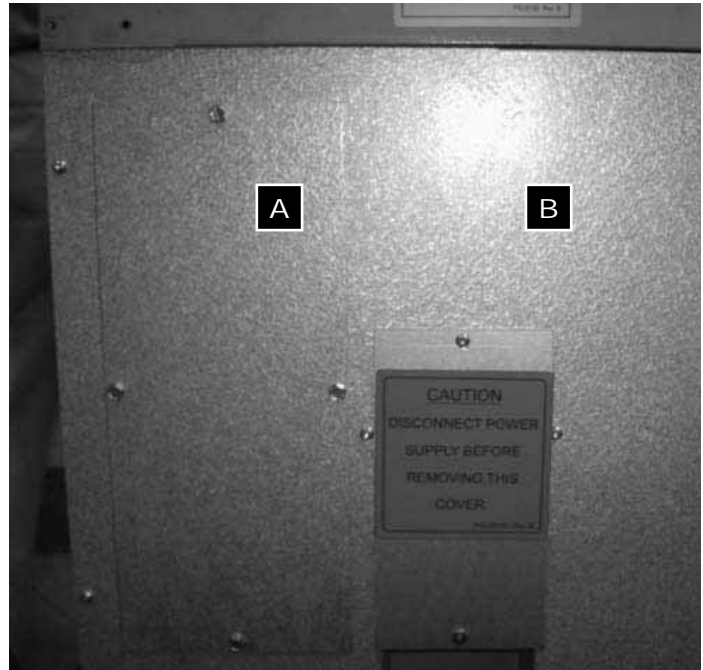

- Disconnect the gas supply line **C** to the regulator **D**.
- Disconnect the flex tube **E** from the top of the regulator.
- Hold the regulator in one hand while removing the two (2) screws **F** from the regulator bracket. Remove the regulator through the access hole.
- Reassemble the regulator in the reverse order.
- Turn the gas supply on and check for leaks using a gas leak detector or bubble forming fluid.
- Turn on the power at the junction or fuse box. Test the cooktop for proper operation according the installation instructions.
- Turn off the power and gas supply. Reinstall the gas regulator access cover.
- Push the range back into position in the wall or cabinet.
- Turn on gas supply and power. Test the cooktop to ensure that repairs were properly completed.

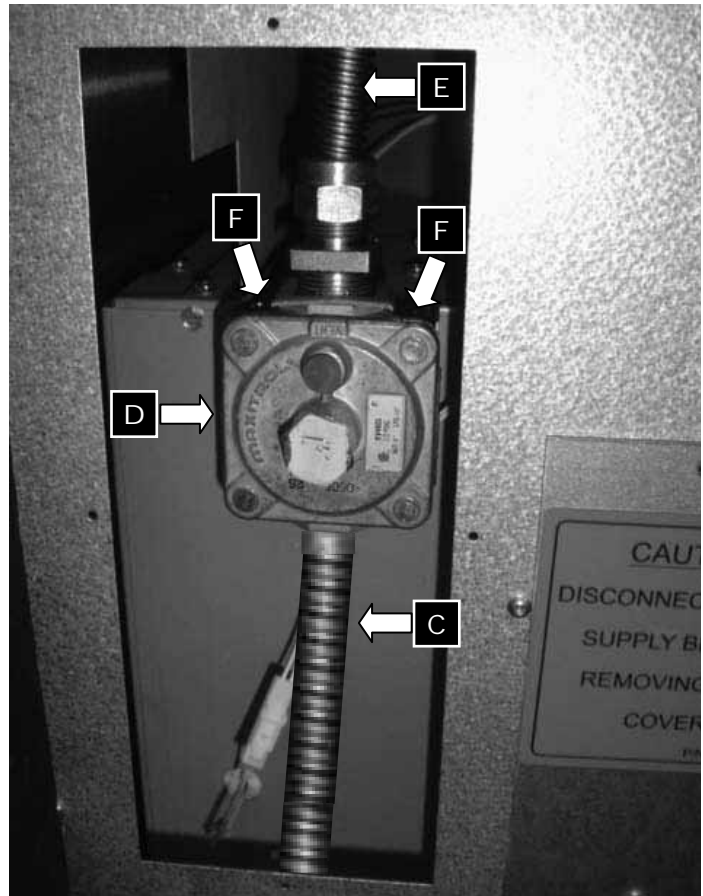

Cooktop Component Repair (continued)

Igniters and Orifices (injectors)

Replacement of the crown burner igniters or orifices require the removal of the spill trays. The spill trays do not need to be removed to replace the stack burner igniters or orifices.

Stack Burner

- Turn off the gas supply at the supply valve and power to the range at the junction or fuse box.
- Remove the grates.
- Remove the burner ring and burner cap from the stack burner.
- Remove both T20 Torx head screws from the top of the stack burner base **G**.
- Remove the burner head. Slip the igniter wire **H** off of the igniter **I** as you remove it.

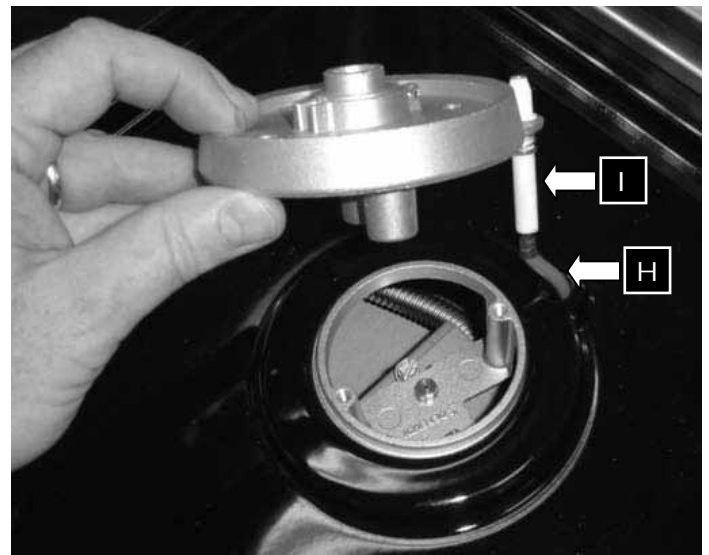
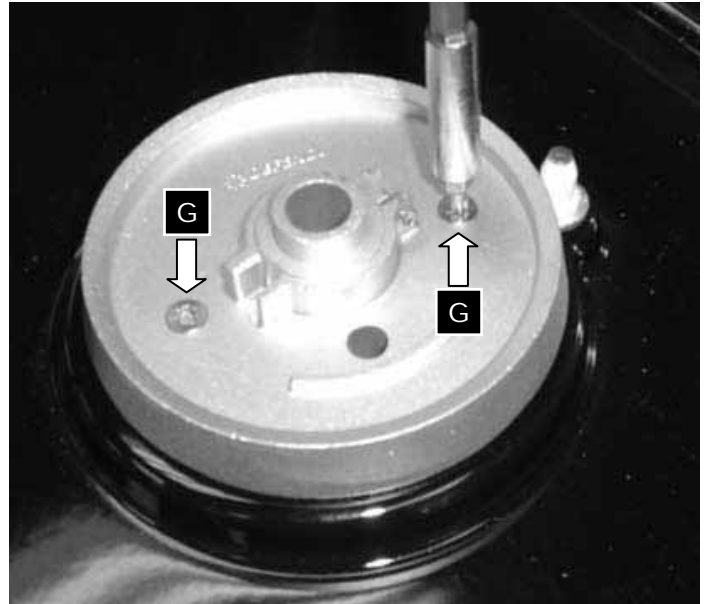

Stack burner igniter replacement

- The stack burner igniter is mounted to the side of the stack burner base. Pry the retainer ring **J** at the bottom of the igniter spring **K** off the igniter **L**.
- Pull the igniter out of the burner base.
- Reattach the igniter to the base.

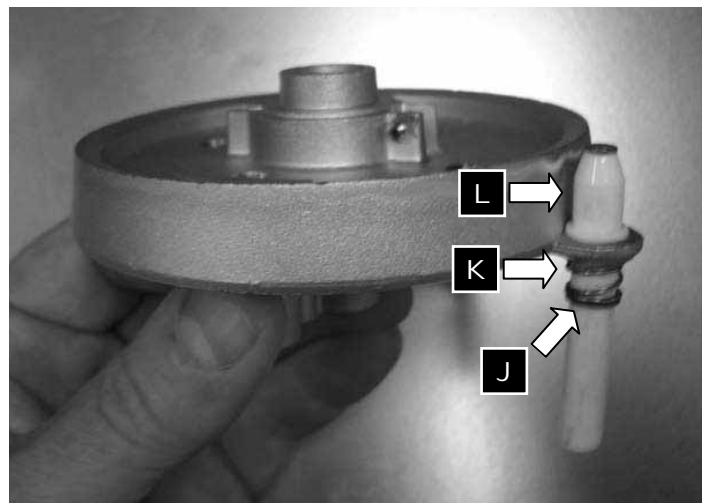

Cooktop Component Repair (continued)

Stack burner orifice replacement

- Use a 7 mm hex driver or socket to remove the orifice from the burner base. The main orifice **M** is located in the center of the burner. The simmer orifice **N** is located near the outside of the base. Consult the Dacor technical service department for the correct orifice size. The size of each orifice is stamped on its side.
- Tighten the replacement orifice into place with the 7 mm hex tool.
- Repeat the above steps for any other stack burners that need to be serviced.

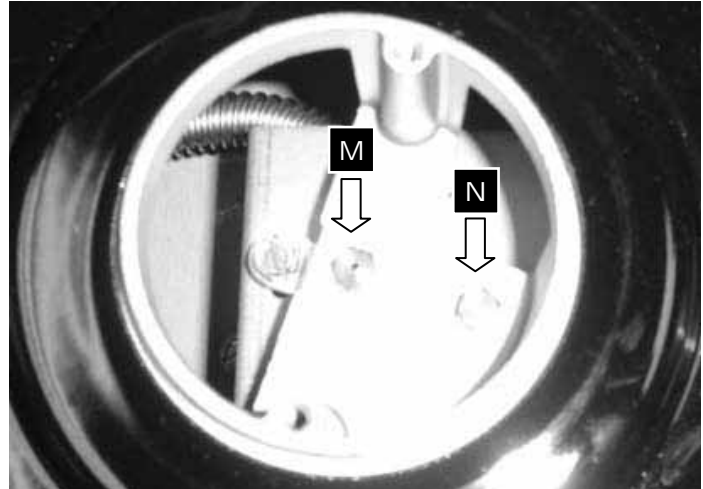

Crown Burner

- Turn off the gas supply and power to the range at the junction or fuse box.
- Remove the spill trays. See the *Removing the Spill Trays* section on page 8-7.

Crown burner igniter replacement

- The crown burner igniter is mounted in the crown burner base. Pry the retainer ring **O** at the bottom of the igniter spring **P** off the igniter **Q**.
- Slip the igniter wire off and pull the igniter out of the burner base.
- Reattach the igniter to the base in the reverse order.

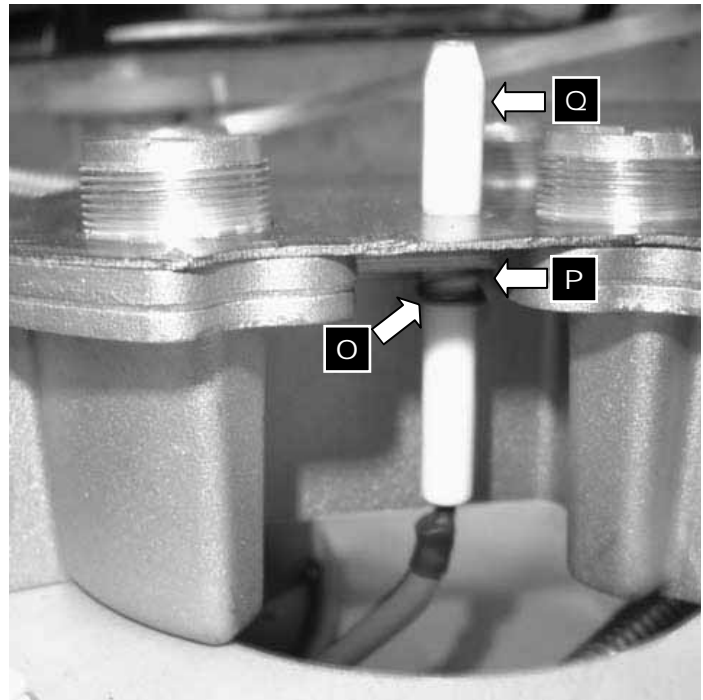

Crown burner orifice replacement

Consult Dacor technical service department for the correct orifice sizes. The size of each orifice is stamped on its side.

- The main orifice **R** on the crown burner is located at the end of the venturi tube assembly **S**. Use a 7 mm hex wrench to remove and install the orifice.

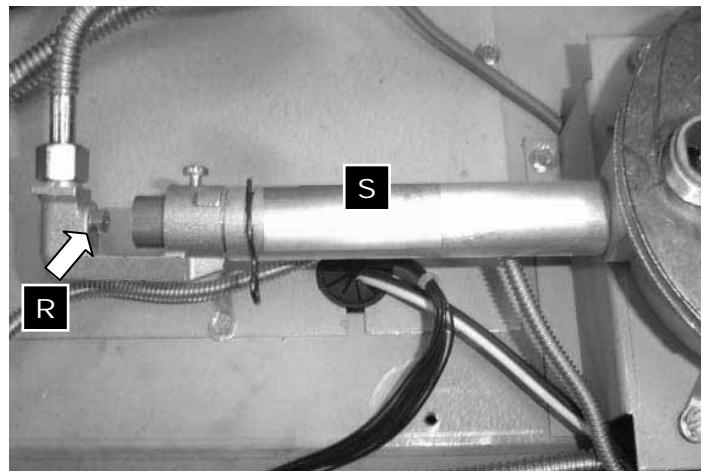

SECTION 9 - COMPONENT REPAIR

Crown burner orifice replacement (continued)

- The simmer orifice is attached to a fitting on the side of the crown burner. Remove the fitting retaining clip **T** to access the simmer orifice fitting.
- Pull the fitting **U** out of the side of the burner.
- Use a 7 mm hex wrench to remove the simmer orifice **V** from the fitting.
- Tighten the replacement orifice into place with a 7 mm hex wrench.
- Repeat the above steps for the other crown burner if it requires service.

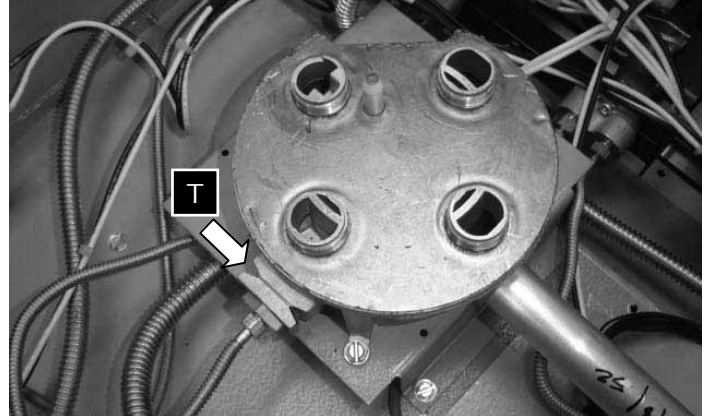

Venturi Adjustment

For proper operation, the gap between the end of the crown burner main orifice **R** and the end of the venturi **X** needs to be set to 9 mm.

- To adjust the venturi gap, loosen the set screw **W** on the side of the venturi assembly.
- Slide the venturi in and out of the venturi assembly to adjust the gap.

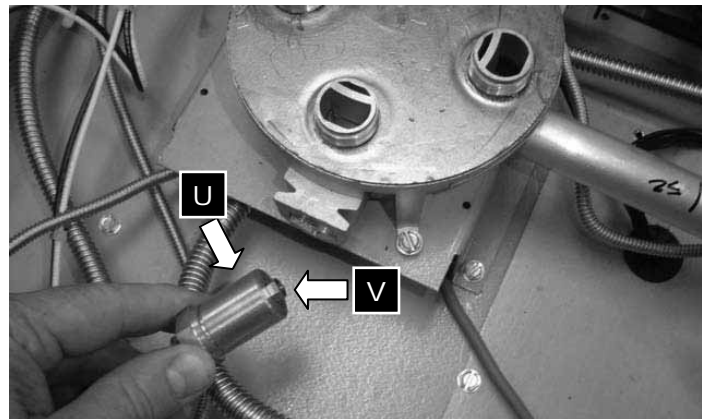

After Burner Service is Complete:

- Reinstall the spill trays.
- Reattach the igniter wires to the stack burner igniters.
- Reassemble the cooktop and test it to ensure that repairs were properly completed.

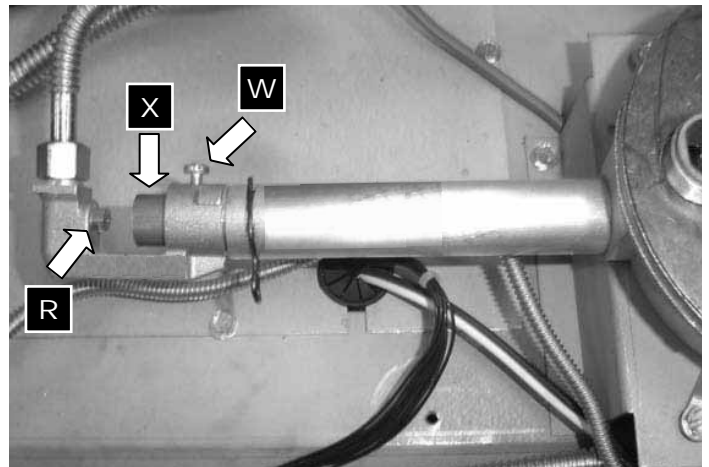

Cooktop Component Repair (continued)

Igniter Module

- Turn off the gas supply and power to the range at the junction or fuse box.
- Remove the spill trays. See the *Removing the Spill Trays* section on page 8-7.
- Determine the igniter to be replaced by tracing the igniter wire **G** from the burner that is not sparking back to the module **H**. The igniter modules are located under the igniter module insulation **I**.
- Disconnect the igniter wire and power supply wires **J** from the module.
- Remove the screws that hold the module to the chassis.
- Install the new module, reconnect the wire and replace the insulation.
- Reassemble the cooktop and test it to make sure that it has been reassembled properly.

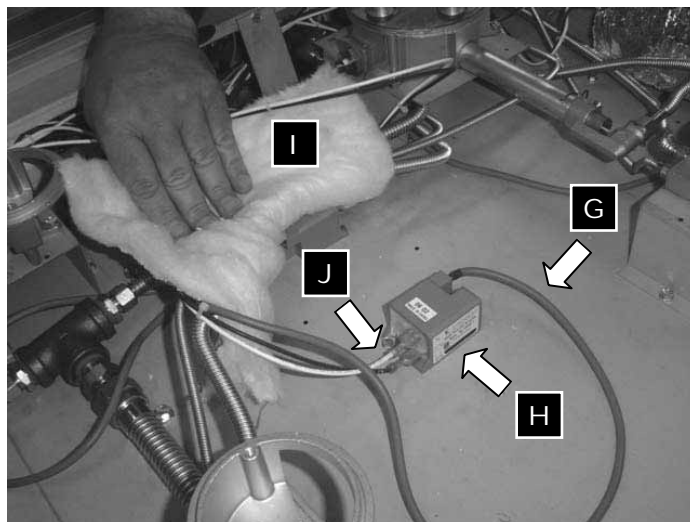

Knob Lights (LED assembly)

- Turn off the gas supply and power to the range at the junction or fuse box.
- Remove the spill trays. See the *Removing the Spill Trays* section on page 8-7.
- Pull off the knob in front of the LED assembly to be removed. Doing so will make it easier to see the LED assembly from the back side.

The LED is held in place by the LED holder **A** above the valve stem **B**.

- To remove the LED, push in on the LED gently with your finger. Then reach in from the back side of the cooktop front panel **C** and pull back on the wires connecting to the LED.
- Disconnect the LED assembly **D** at the connector **E** about six (6) inches from the LED.
- When remounting the LED, push the LED into the LED holder from the back side until it stops.
- Replace the knob.
- Reassemble the cooktop and test it to make sure the LED is working and that the cooktop has been reassembled properly.

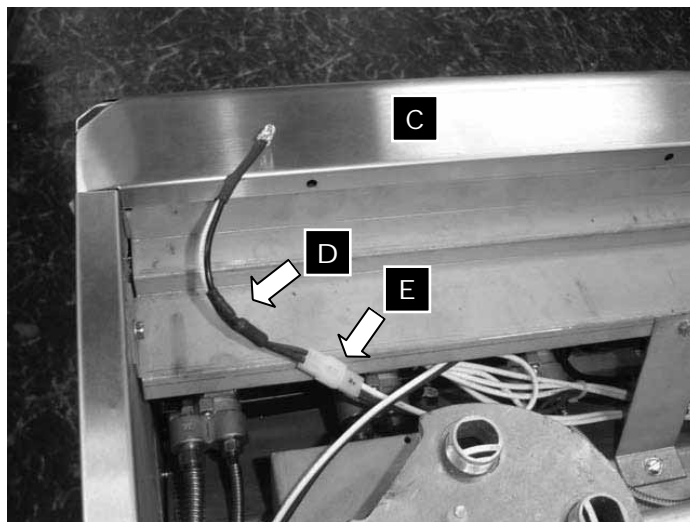
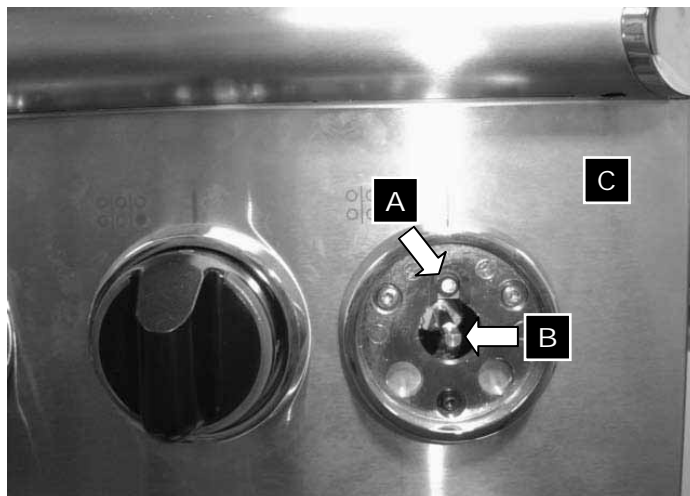

Cooktop Component Repair (continued)

Manifolds and Valves

- Turn off the gas supply and power to the range at the junction or fuse box.
- Remove the spill trays. See the *Removing the Spill Trays* section on page 8-7.
- Remove the torx head screws from the end caps **F** through the access holes **G** on the bottom of the front panel lip **H**.

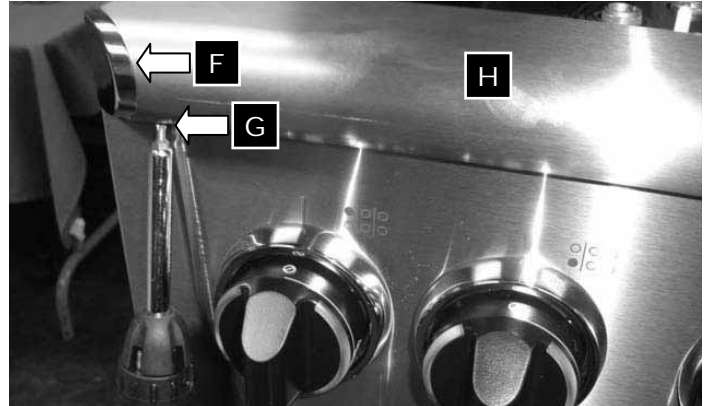

- Remove the end cap.



- Pull all the knobs off the front of the range.
- Remove the side panel screw inside the front panel lip.



- Remove the screws from the bottom of the cooktop front panel **C**.



Cooktop Component Repair (continued)

- Make sure the oven control panel **I** is in the lowered position. See page 5-2.
- Pull the bottom of the front panel **J** out and lift it up and off the range.

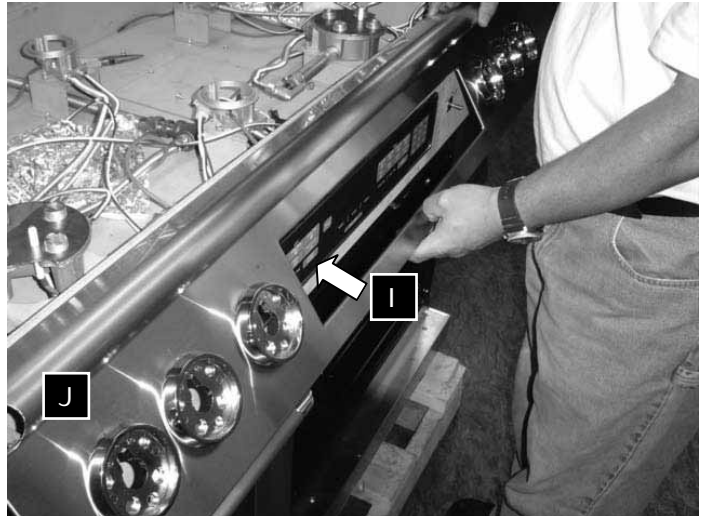

- Remove all of the screws that hold the channel support **K** to the cooktop chassis. Lift the channel support out of the chassis.



- Disconnect the wires **L** from the valves connected to the manifold **M** to be removed.
- Disconnect the flex tubes **N** from the valves and the manifold to be removed.
- Remove the nuts that attach the manifold assembly to the sub-panel **O**.

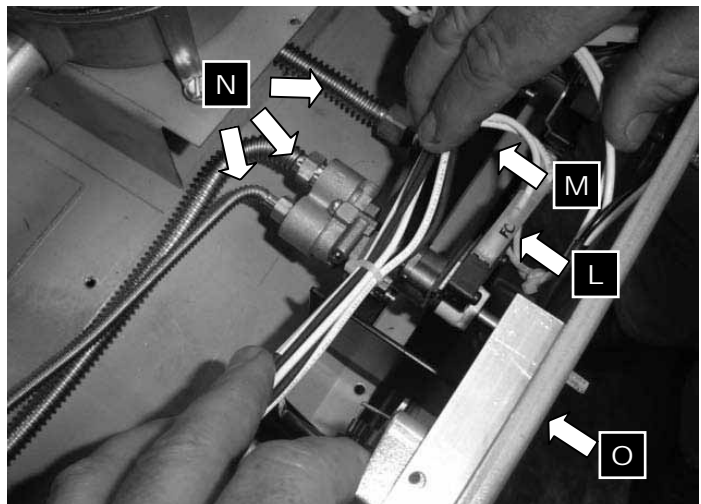

SECTION 9 - COMPONENT REPAIR

Manifolds and Valves (continued)

- To remove the valves **P**, remove the bolts **Q** from the bottom of the manifold **R**.
- After repairs are completed, reassemble the cooktop and test it to make sure repairs were properly completed.

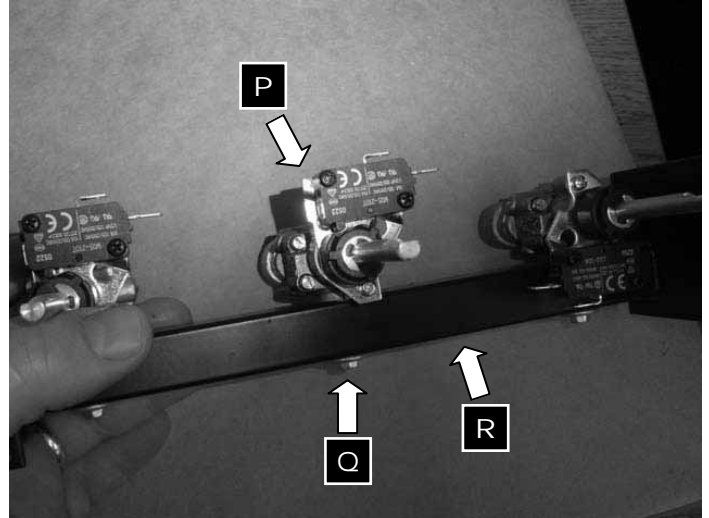

Oven Component Repair

Smoke Eliminator

- Turn off the gas supply at the supply valve and power to the range at the junction or fuse box.
- Remove the oven door as described on page 8-1.
- Remove the oven racks.
- Remove the convection filter from the back wall of the oven by lifting it up and out.
- Remove the four (4) screws that hold the convection baffle **A** to the back of the oven **B** and remove it.
- Model ER48D Only: If removing the smoke eliminator for the left oven, remove the screws that hold the broil element **C** to the ceiling and slowly remove it. Pull the wires through the back wall with a gentle rocking motion to prevent them from disconnecting from the element inside the back wall. Disconnect the wires from the element after they have pulled through the wall.

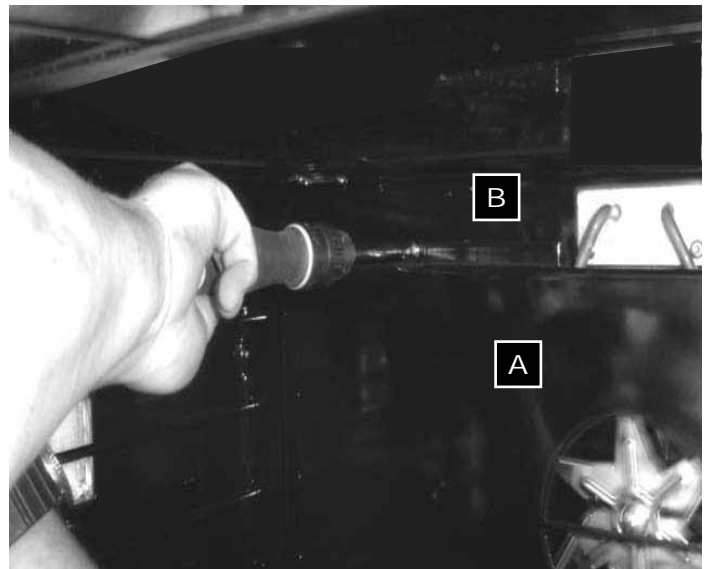

Oven Component Repair (continued)

The oven chamber smoke eliminator **D** is located on the ceiling of the oven chamber near the back. Exact location varies with model.

- Remove the three (3) screws that hold the smoke eliminator in place. Be careful not to scratch the back of the oven with the screwdriver during removal and installation.
- To install the smoke eliminator, fasten it in place with the three (3) existing screws.
- Reinstall the broil element if necessary.
- Reinstall the convection baffle. The end with the slots on the side goes up.
- Reinstall the convection filter.
- Reinstall the oven racks.
- Reinstall the oven door as described on page 8-2.
- Test the oven to ensure that repairs were properly completed.

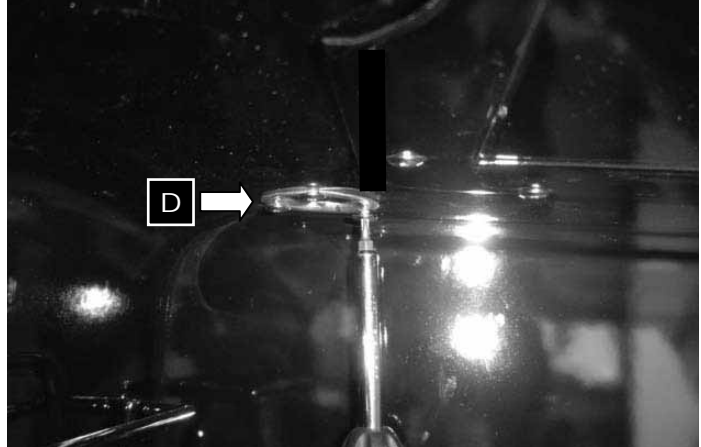

Oven Component Repair (continued)

Convection Element, Fan and Fan Motor

- Turn off the gas supply and power to the range at the junction or fuse box.
- Remove the oven racks from the oven.
- Remove the oven door(s) as described on page 8-1.
- Remove the convection filter from the back wall of the oven by lifting it up and out.

Convection Baffle Removal

- Remove the four (4) screws that hold the convection baffle **P** in place. The screws are located near the four corners of the baffle at the back **Q** of the oven.
- Remove the convection baffle.

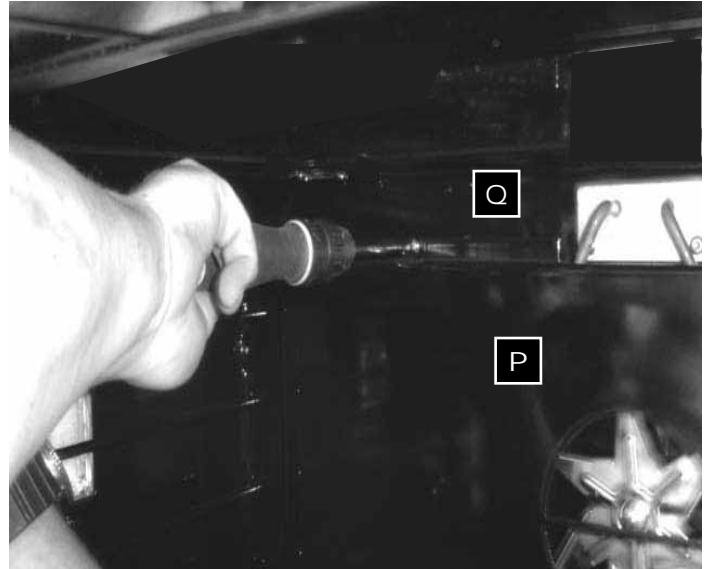

Convection Element Removal

- Remove the back panel as described on page 8-3.
- Disconnect the convection element wires **R** from the element behind the back panel.

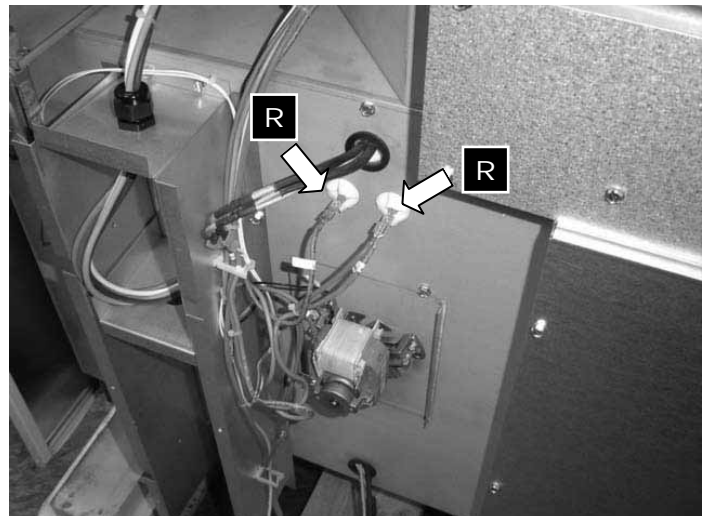

- Remove the three (3) screws **S** holding the convection element **T** in place.
- Grasp the convection element near the top and pull it slowly out of the back wall with a gentle, rocking motion.
- Replace and reconnect the convection element in the reverse order.

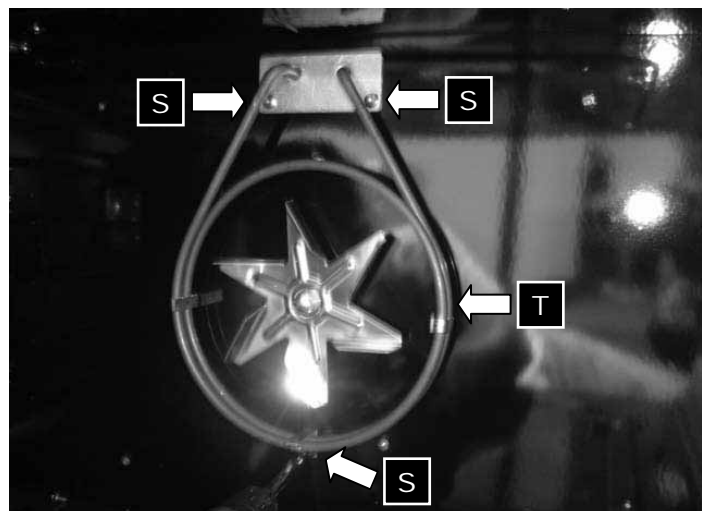

Oven Component Repair (continued)

Convection Fan and Fan Motor Removal

- To remove the convection fan **U**, hold it with one hand and turn the nut **V** clockwise with a wrench.
- With the back cover removed (see page 8-3), label the location of the convection fan wires **W** and disconnect them.
- Remove the three (3) screws **X** that attach the motor **Y** to the back panel to remove it.
- Reassemble the fan motor and fan in the reverse order. When replacing the fan, make sure that the washer is installed behind the fan blade before installing the fan. Use a wrench to tighten the nut counterclockwise.
- Reinstall the four (4) mounting screws that hold the baffle in place.
- Reinstall the convection filter.
- Reinstall the racks.
- Reinstall the oven door as described on page 8-2.
- Test the oven to ensure that repairs were properly completed.

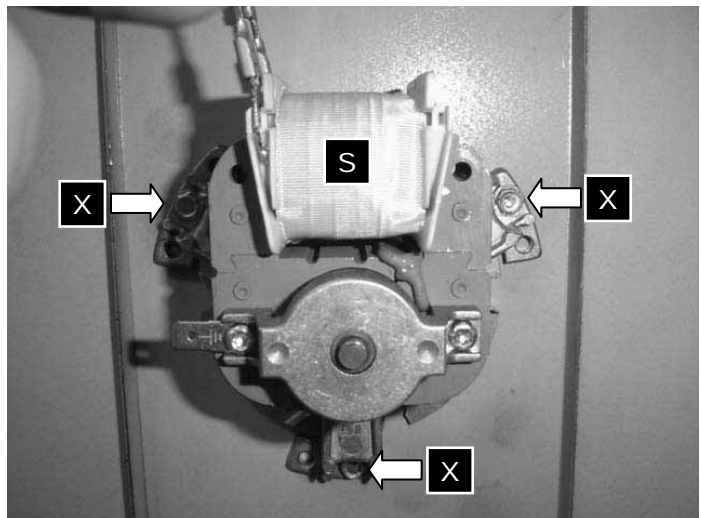
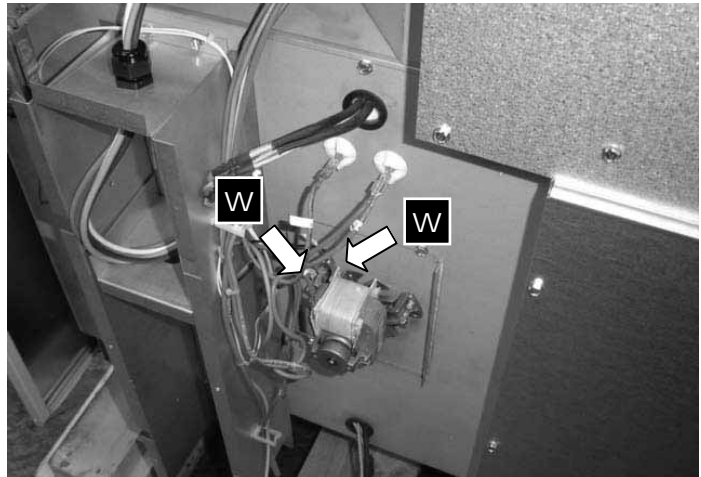
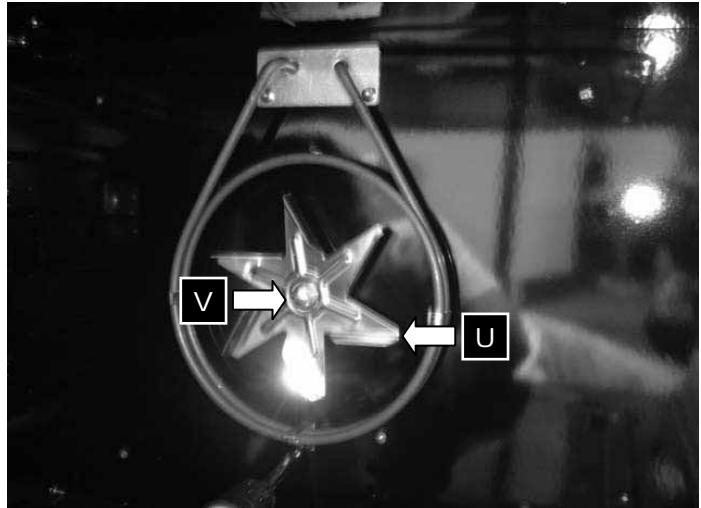

Oven Component Repair (continued)

Broil Element

Left oven on Model ER48D:

- Turn off the gas supply at the supply valve and power to the range at the junction or fuse box.
- Remove the oven door as described on page 8-1.
- Remove the oven racks.
- Remove the convection filter **E** from the back wall of the oven by lifting it up and out.
- Remove the four (4) screws that hold the convection baffle **A** to the back of the oven and remove it.
- Remove the screws that hold the broil element **C** to the ceiling and slowly remove it. Pull the wires through the back wall with a gentle rocking motion to prevent them from disconnecting from the element inside the back wall. Disconnect the wires from the element after they have pulled through the wall.
- When replacing the element, connect the wires to the element and gently push them into the holes on the back oven wall as you reposition the element. Reattach it using the existing screws.
- Reinstall the convection baffle and filter.
- Reinstall the oven racks.
- Reinstall the oven door as described on page 8-2.
- Test the oven to ensure that repairs were properly completed.

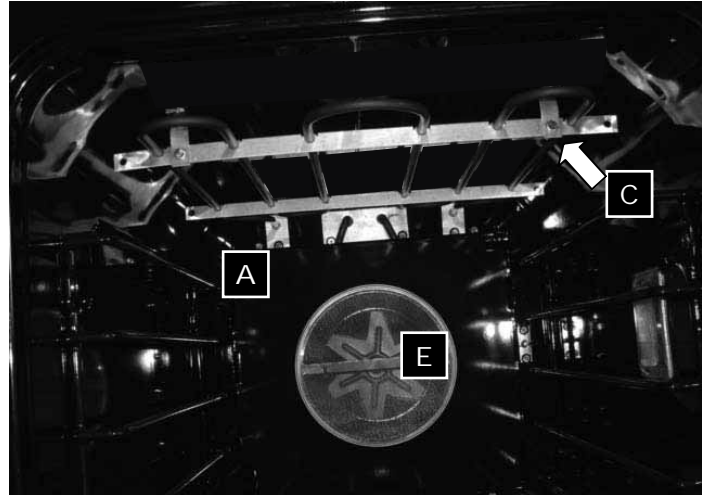

Broil Element for Right Oven on Model ER48D and Oven on Model ER36D:

- Turn off the gas supply and power to the range at the junction or fuse box.
- Remove the oven door as described on page 8-1.
- Remove the oven racks.
- While holding the broil element assembly **F** in place with one hand, remove the screws that hold it in place.
- Gently lower the broil element out of the ceiling of the oven chamber.

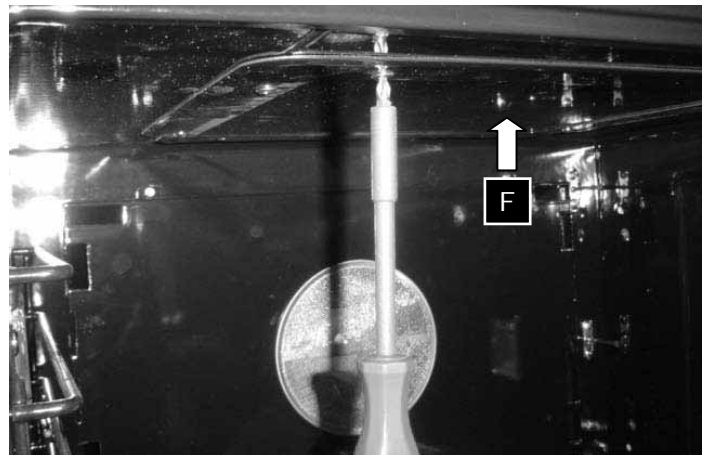

Oven Component Repair (continued)

- Label the wires **G** that connect to the broil element terminal.
- Gently remove the broil element wires from the terminal block **H** on the broil element assembly.

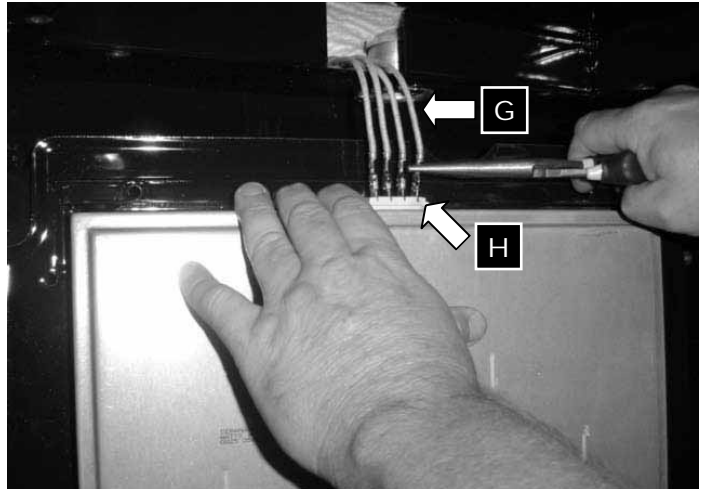

- Place the broil element assembly on a flat, padded surface and remove the screws from each of the four (4) corners.



- The broil element assembly separates into three (3) components, the broil element **I**, the broil element frame **J**, and the broil element glass **K**.
- To reassemble the broil element assembly, use the four (4) existing screws. Insert the broil element glass into the frame with the smooth side down. Insert the broil element with the ribbon wire **L** down and line up the terminals **H**, with the terminal cut-out **M** in the frame.

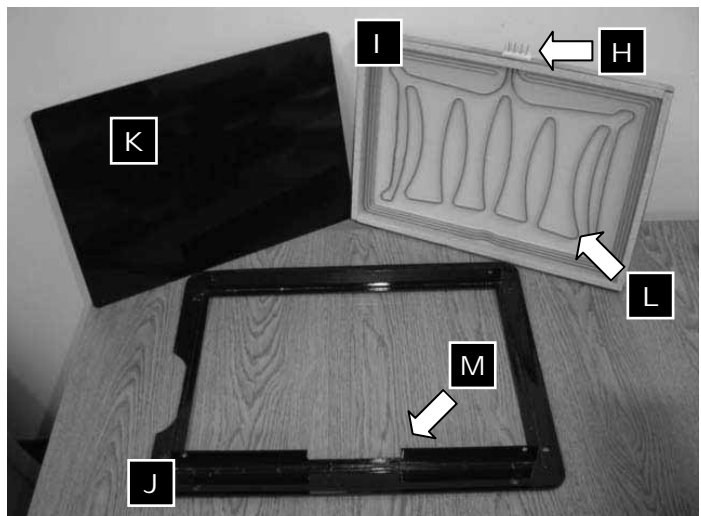

Broil Element (continued)

- Place the broil element into the oven chamber with the glass facing down and the terminals toward the back of the oven.
- Lift the back of the element up and reconnect the broil element wires to the terminals on the broil element assembly. Make sure that the wires are connected to the proper terminals.
- Insert the broil element assembly into the hole in the oven ceiling while pushing the broil element wires into the access hole toward the back.
- Hold the broil element assembly in place with one hand while replacing the eight (8) existing screws that hold it in place.
- Reinstall the racks.
- Reinstall the oven door as described on page 8-2.
- Test the oven to ensure that repairs were properly completed.



Bake Element

Left oven on Model ER48D:

- Turn off the gas supply at the supply valve and power to the range at the junction or fuse box.
- Remove the oven door as described on page 8-1. Remove the oven racks.
- Remove the convection filter **A** from the back wall of the oven by lifting it up and out.
- Remove the four (4) screws that hold the convection baffle **B** to the back of the oven and remove it.
- Remove the screws that hold the bake element **C** in place. Pull the wires through the back wall with a gentle rocking motion to prevent them from disconnecting from the element inside the back wall. Disconnect the wires from the element after they have pulled through the wall.
- When replacing the element, connect the wires to the element and gently push them into the holes on the back oven wall as you reposition the element. Reattach it using the existing screws.
- Reinstall the convection baffle and filter.
- Reinstall the oven racks. Reinstall the oven door as described on page 8-2.
- Test the oven to ensure that repairs were properly completed.

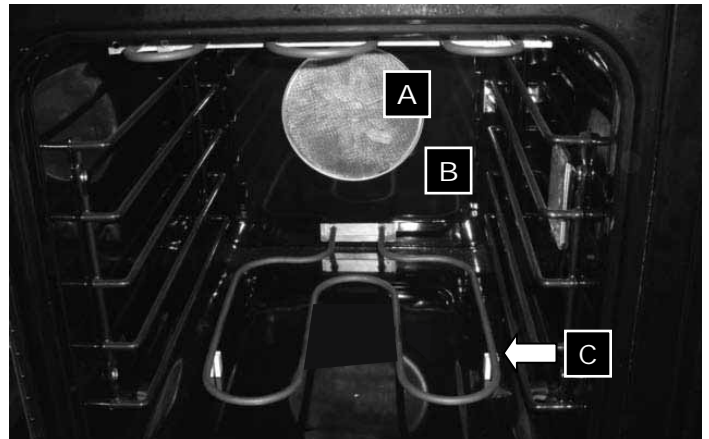

Oven Component Repair (continued)

Broil element for right oven on Model ER48D and oven on Model ER36D:

- Turn off the gas supply at the supply valve and power to the range at the junction or fuse box.
- Remove the oven door as described on page 8-1.
- Remove the oven racks.
- Remove the screws that hold the bake element frame **D** in place on the floor of the oven.

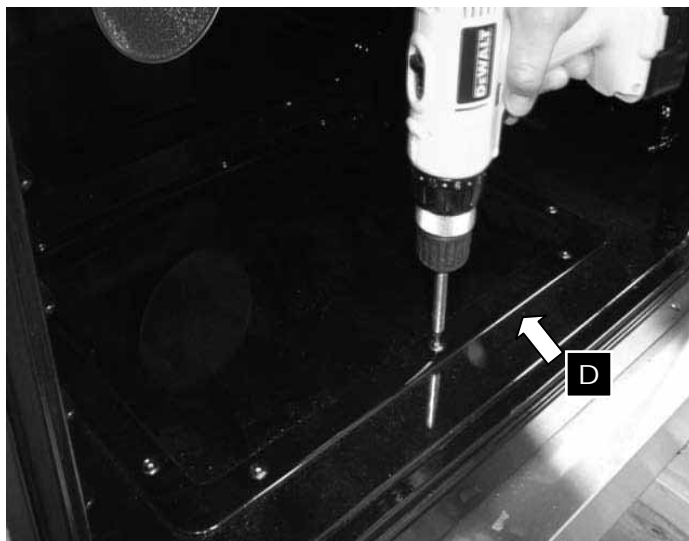

- Remove the bake element frame and glass **E**.
- If replacing the bake element **F**, pull it up and out of the floor of the oven.

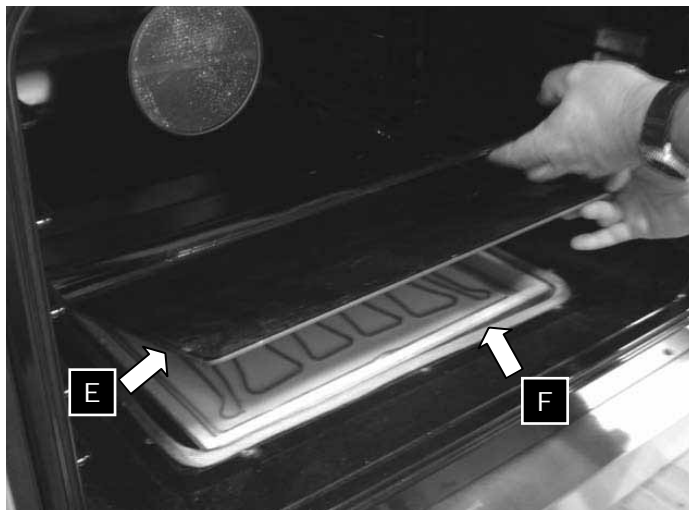

- Label the wires that connect to the bake element terminals **G**. When reconnecting the wires, make sure that the wires are connected to the proper terminal.
- If replacing the bake element glass, make sure that the smooth side of the glass is facing up when placing it in the oven.
- When reassembling the bake element in the floor of the oven, place the bake element glass inside the bake element frame and place it over the top of the bake element in the floor of the oven.
- Hold the bake element frame in place with one hand while replacing the eight (8) existing screws that hold it in place.
- Reinstall the racks.
- Reinstall the oven door(s) as described on page 8-2.
- Test the oven to ensure that repairs were properly completed.

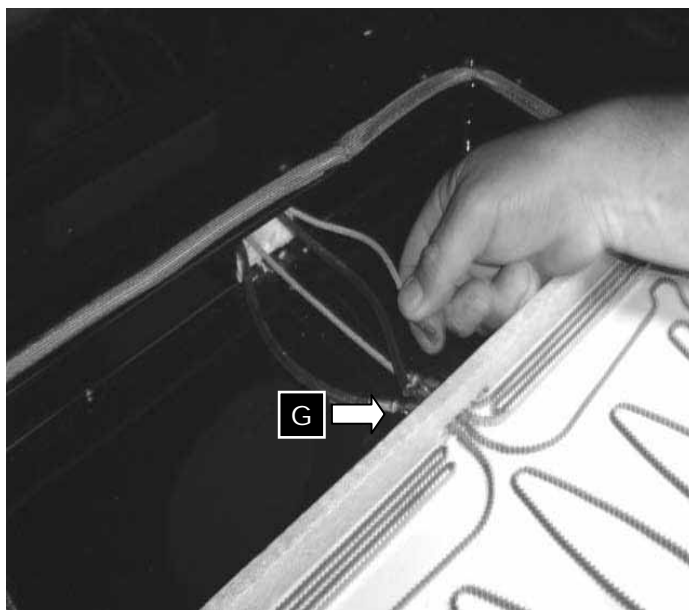

Oven Component Repair (continued)

Temperature Sensor and Rack Support

The following applies to all ER36D and ER48D ovens, including the left oven on model ER48D:

- Turn off the gas supply at the supply valve and power to the range at the junction or fuse box.
- Remove the oven door as described on page 8-1.
- Remove the oven racks from the oven chamber.
- Remove the four (4) screws that hold the right rack support **H** in place. Be careful not to scratch the inside surface of the oven when removing it.
- Remove the two (2) screws that hold the temperature sensor **I** in place. Be careful not to scratch the baffle when removing the screws.
- When removing the temperature sensor, pull the wires attached to the sensor gently toward you through the hole in the back of the oven to expose the connector. Do not pull hard on the wires because the connector may come loose inside the oven wall. Use a screwdriver, if necessary, to move the insulation around behind the hole to allow the connector to slide out into the oven chamber.
- Disconnect the temperature sensor wires at the connector **J** to remove it. Connect the replacement temperature sensor.
- When reinstalling the temperature sensor, gently push the connector and excess wire through the access hole and insulation at the back of the oven.
- Tighten the temperature sensor into place with the two (2) existing mounting screws.

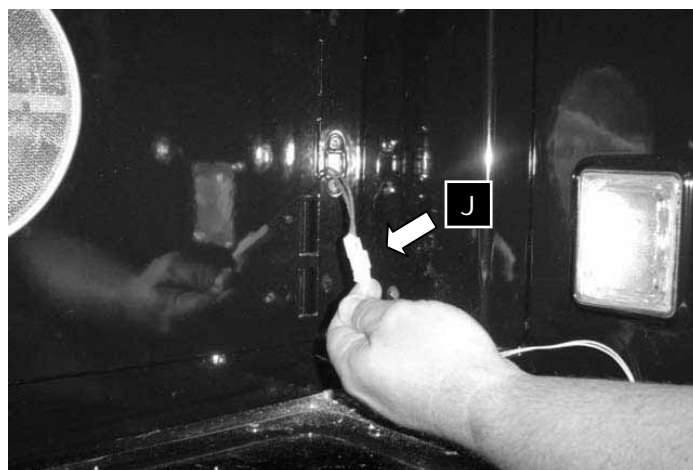
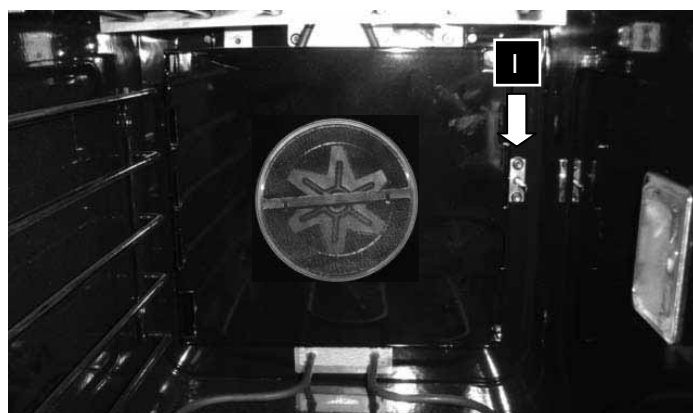
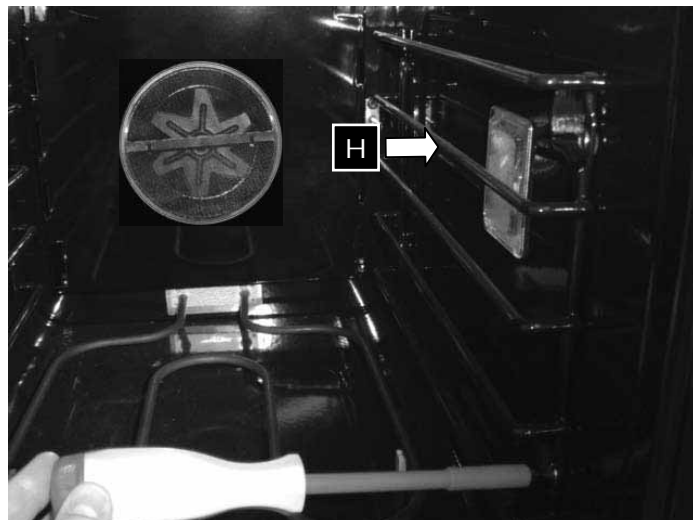

Oven Component Repair (continued)

Reinstalling the Rack Support:

CAUTION

- To prevent damage to the oven wall, insert the rack support carefully.

- Insert one end of the rack support into the oven at a 20° angle to the sidewall.
- Rotate the rack support into place, matching the four (4) protruding pins on the rack support to the holes in the oven wall.
- Mount the rack support in place using the four (4) existing screws.
- Reinstall the racks and the oven door as described in section 8.
- Test the oven to ensure that repairs were properly completed.



Light Fixtures and Meat Probe

NOTE

- On model ER48D: There is no meat probe connector on the left oven.
- The rack support does not need to be removed to service the meat probe connector.

- Turn off the gas supply at the supply valve and power to the range at the junction or fuse box.
- Remove the oven door as described on page 8-1.
- Remove the oven racks from the oven chamber.
- Move the range out from the wall and remove the right side panel according to page 8-5.
- Remove the four (4) screws that hold the right rack support **H** in place. Be careful not to scratch the inside surface of the oven when removing it.

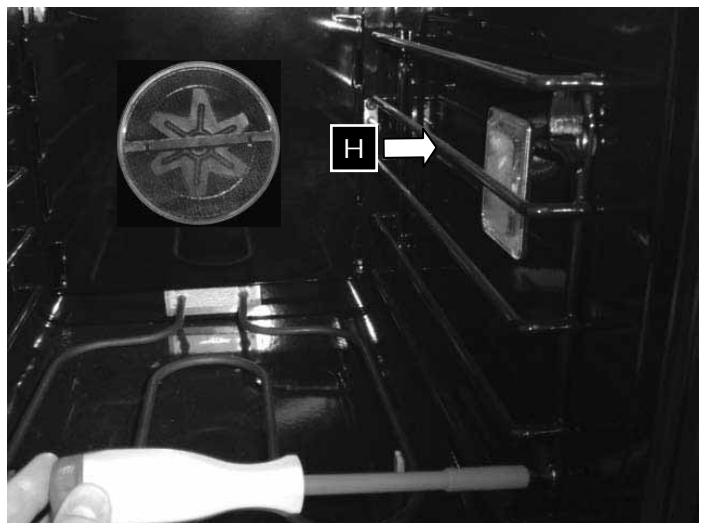

Oven Component Repair (continued)

Light Fixtures and Meat Probe (continued)

- Remove all the mounting screws from the intake grill **K**. The screws attach the grill to the underside of the cooktop front panel **I** and the top of the oven chambers(s) **J**.
- Remove the intake grill.

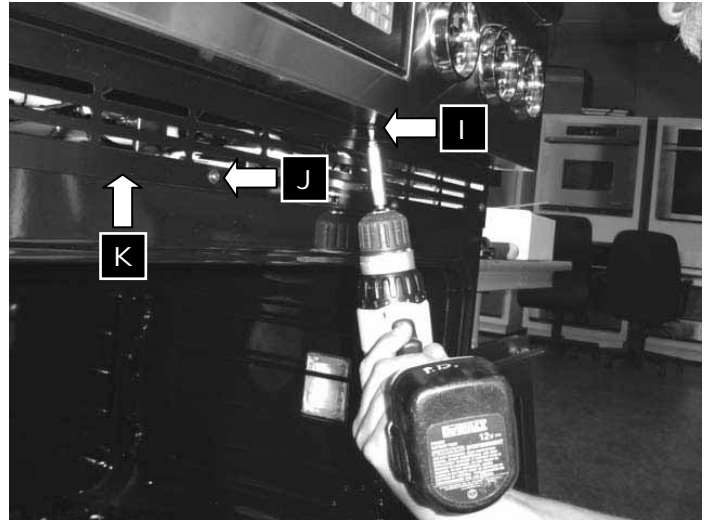

Meat Probe Connector Removal

- Using a 3/8" nut driver, remove the nut **L** that holds the meat probe socket in place.
- Push the meat probe socket through the insulation and wire access hole in the wall of the oven. Use a screwdriver, if necessary, to move the insulation around behind the hole to allow the socket to pass through to the outside of the oven chamber.



- Trace the meat probe wire up the side of the range into the space **M** above the oven chamber. Find the connector on the wire inside, disconnect it and pull the meat probe connector assembly out of the range.
- Install the new meat probe connector in place of the old one.



Oven Component Repair (continued)

Light Fixture Removal

CAUTION

- Use the lens pry stick with caution. Do not cause uneven stress on the lens.
- Do not touch halogen light bulbs with your hand. Hand oils left on the bulb will cause early failure.

- Trace the light fixture wire up into the space **M** above the oven chamber. Find the connector on the wire inside, and disconnect it.
- Gently insert the pointed end of the lens pry stick (Dacor Part No. 62974), supplied with the range, under the center edge of the lens. Hold your hand under the lens for support, then pull it straight out.
- Using a glove, pull the light bulb straight out of the light socket (do not turn).
- Pull the light fixture out of the hole in the side of the oven, pulling the wire and connector with it. Use a screwdriver, if necessary, to move the insulation around behind the hole to allow the connector to slide out of the wall into the oven chamber.
- Gently push the connector and wire attached to the replacement light fixture through the hole and insulation in the wall of the oven. Use a screwdriver, if necessary, to move the insulation around behind the hole to allow the connector to pass through to the outside of the oven chamber.
- Route the light fixture wire into the space above the oven chamber and reconnect it.
- Using a glove, insert the bulb into the replacement light fixture socket. If replacing the bulb, use only Dacor light bulb Part No. 100429. Using a screwdriver, pry the locking tabs opposite socket of the old light fixture out. Prying the tabs out will allow the fixture to be removed from the oven wall.
- Reinstall the lens cover by aligning the cover over the opening and gently pressing it into its original position. Be sure that the side of the lens cover with the cutout lines up with the light socket.



Light Fixtures and Meat Probe (continued)

Reinstalling the Rack Support:

- Insert one end of the rack support into the oven at a 20° angle to the sidewall.
- Rotate the rack support into place, matching the four (4) protruding pins on the rack support to the holes in the oven wall.
- Mount the rack support in place using the four (4) existing screws.
- Reinstall the racks and the oven door as described in section 8.
- Test the oven to ensure that repairs were properly completed.



Door Latch and High Limit Switch

- Turn off the gas supply at the supply valve and power to the range at the junction or fuse box.
- Remove the oven door as described on page 8-1.
- Remove the oven racks from the oven chamber.
- Remove all the mounting screws from the intake grill **K**. The screws attach the grill to the underside of the cooktop front panel **I** and the top of the oven chamber(s) **J**.
- Remove the intake grill.
- Label and disconnect the wires from the door latch or high limit switch as necessary.
- Use a ratchet to remove the sheet metal screws that hold the door latch **A** or high limit switch **B** in place. The door latch is held in place by four (4) screws. The high limit switch is held in place by two (2) screws.
- Reconnect the wires to the door latch or high limit switch after mounting the replacement.
- Reinstall the racks and the oven door as described in section 8.
- Test the oven to ensure that repairs were properly completed.

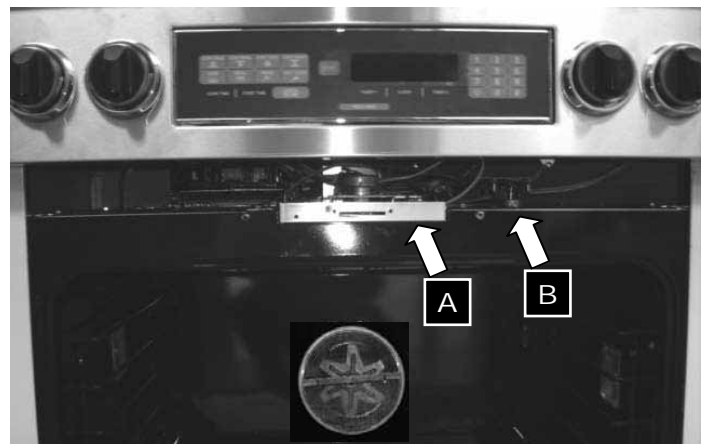
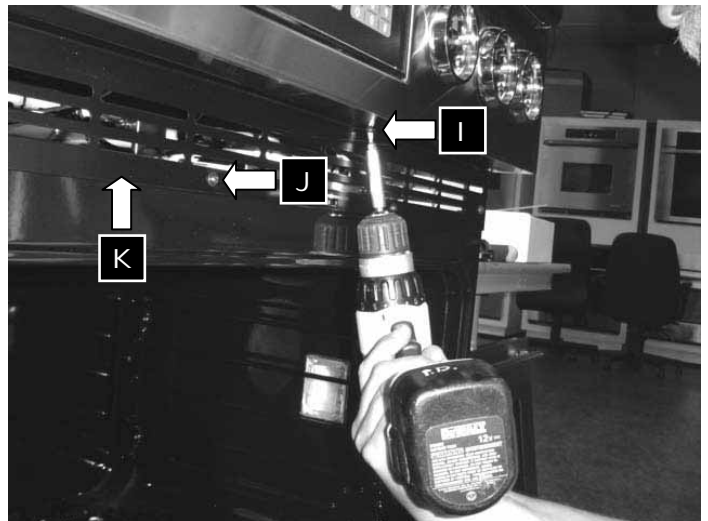

Oven Component Repair (continued)

Cooling Fan Assembly Repair

- Turn off the gas supply at the supply valve and power to the range at the junction or fuse box.
- Move the range out from the wall or cabinet and remove the back panel as described on page 8-3.
- The cooling fan assembly **D** is mounted to the exhaust duct cover. Remove the screws from the exhaust duct cover **E** to access the cooling fan assembly. Do not remove the fan mounting screws **X**.
- Label and disconnect the wires **F** from the cooling fan motor as you remove the cooling fan assembly for service.
- Reassemble the cooling fan and duct assemblies in reverse order.
- Replace the back cover.
- Test the oven to ensure that repairs were properly completed.

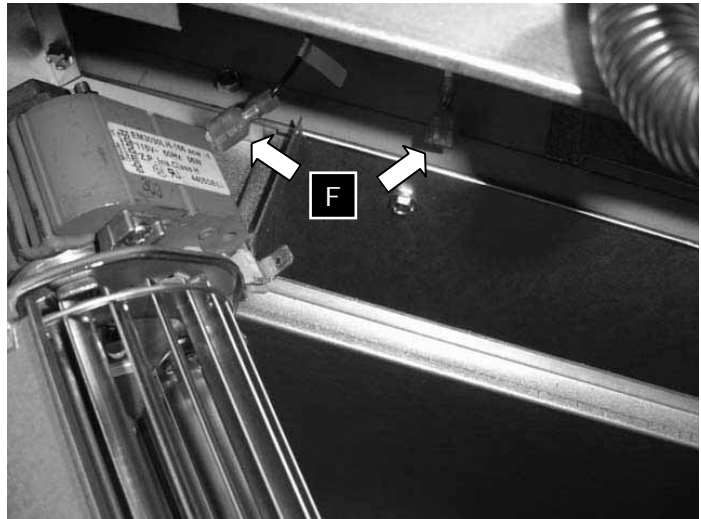
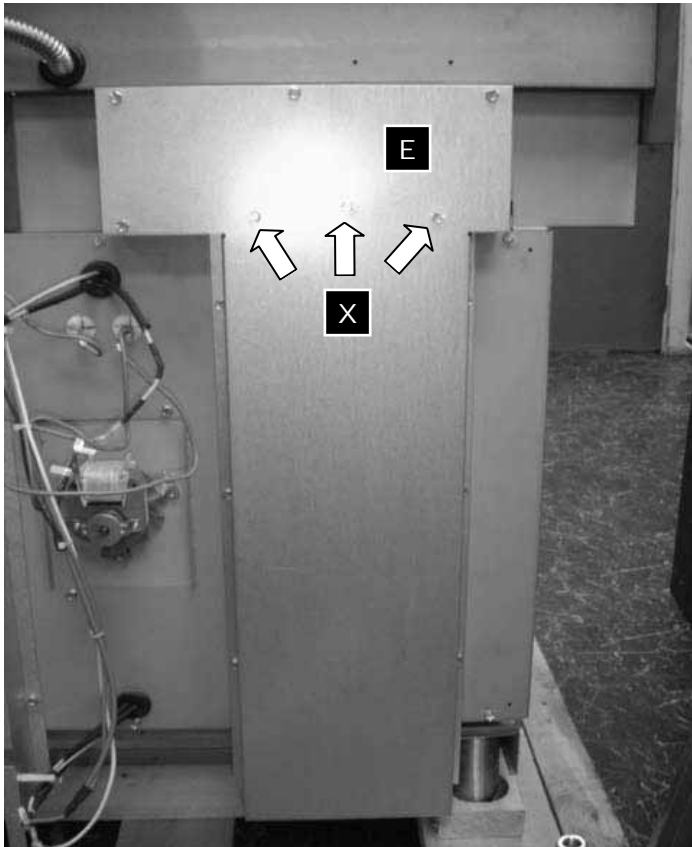

Oven Component Repair (continued)

Power Board and Lighting Transformer

CAUTION

- The printed circuit board assemblies in this range contain electronic components that are sensitive to electrostatic discharge (ESD). Wear a properly grounded antistatic wrist strap when handling or servicing the printed circuit assemblies. Insert the ESD sensitive circuit boards into antistatic bags before placing them on any surface other than the oven chassis.

- Turn off the gas supply at the supply valve and power to the range at the junction or fuse box.
- Remove the spill trays as described starting on page 8-7.
- Remove the relay board cover **G** on the floor of the cooktop chassis.

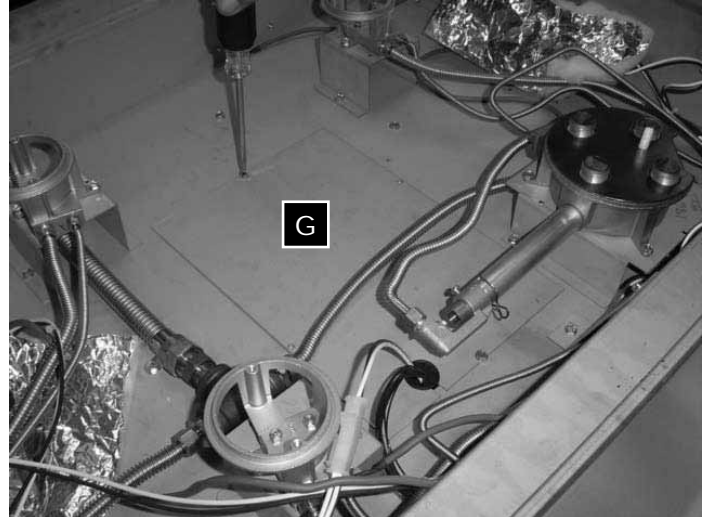

- The power board **H** and the lighting transformer **I** are mounted to the chassis inside the relay board cover.
- Label and disconnect any wires that are disconnected from the power board or transformer before repair or replacement.
- Reassemble the range in the reverse order and test the oven to ensure that repairs were properly completed.

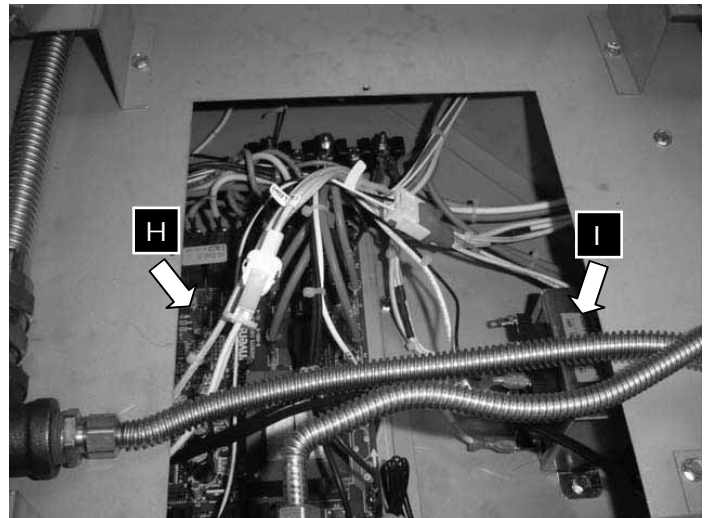

Oven Component Repair (continued)

CAUTION

- The printed circuit board assemblies in this range contain electronic components that are sensitive to electrostatic discharge (ESD). Wear a properly grounded antistatic wrist strap when handling or servicing the printed circuit assemblies. Insert the ESD sensitive circuit boards into antistatic bags before placing them on any surface other than the oven chassis.

Control Panel Repair

Follow these instructions to access the controller board, keypad membrane and mounting hardware.

- Turn off the gas supply at the supply valve and power to the range at the junction or fuse box.
- Remove the spill trays as described starting on page 8-7.
- Remove the torx head screws from the end caps **A** through the access holes **B** on the bottom of the front panel lip **C**.
- Remove the end cap.

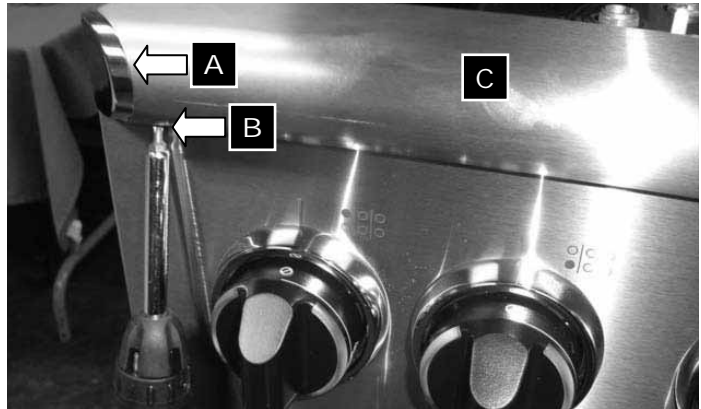

- Remove the side panel screw inside the front panel lip.



SECTION 9 - COMPONENT REPAIR

Control Panel Repair (continued)

- Remove the screws from the bottom of the cooktop front panel **D**.
- Make sure the oven control panel **E** is in the lowered position. See page 5-2.
- Pull the bottom of the front panel **F** out and lift it up and off the range.
- Remove all of the screws that hold the channel support **G** to the cooktop chassis. Lift the channel support out of the chassis.

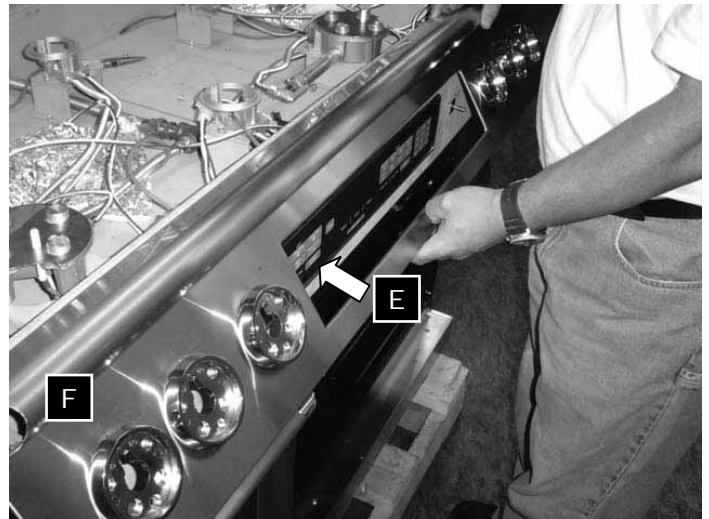
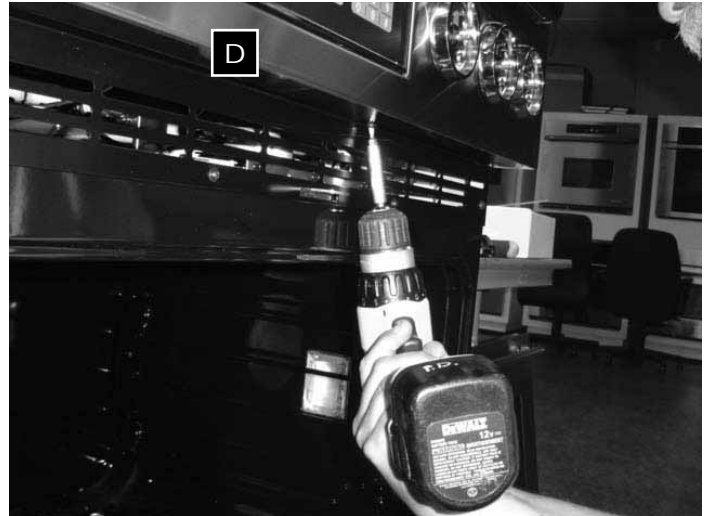

Oven Component Repair (continued)

- To remove the control panel assembly **H** for service, remove the nuts that hold the assembly to the sub panel **I**.
- Label and disconnect any wires that are disconnected from the controller board or keypad membrane before repair or replacement.
- Reassemble the range in the reverse order and test the oven to ensure that repairs were properly completed.

