



ELECTROLUX HOME PRODUCTS NORTH AMERICA

# *SERVICE MANUAL*

*NEXT GEN*

*30" ELECTRIC*

*FREESTANDING RANGES*

*Frigidaire*

**TAPPAN**

**W** White-Westinghouse

**Gibson**

**Kelvinator** 

5995361523

December 2001

# SAFE SERVICING PRACTICES - ALL APPLIANCES

To avoid personal injury and/or property damage, it is important that **Safe Servicing Practices** be observed. The following are some limited examples of safe practices:

1. **DO NOT** attempt a product repair if you have any doubts as to your ability to complete it in a safe and satisfactory manner.
2. Before servicing or moving an appliance:
  - Remove the power cord from the electrical outlet, trip the circuit breaker to the OFF position, or remove the fuse.
  - Turn off the gas supply.
  - Turn off the water supply.
3. Never interfere with the proper operation of any safety device.
4. **USE ONLY REPLACEMENT PARTS CATALOGED FOR THIS APPLIANCE. SUBSTITUTIONS MAY DEFEAT COMPLIANCE WITH SAFETY STANDARDS SET FOR HOME APPLIANCES.**
5. **GROUNDING:** The standard color coding for safety ground wires is **GREEN**, or **GREEN with YELLOW STRIPES**. Ground leads are not to be used as current carrying conductors. It is **EXTREMELY** important that the service technician reestablish all safety grounds prior to completion of service. Failure to do so will create a hazard.
6. Prior to returning the product to service, ensure that:
  - All electrical connections are correct and secure
  - All electrical leads are properly dressed and secured away from sharp edges, high-temperature components, and moving parts
  - All non-insulated electrical terminals, connectors, heaters, etc. are adequately spaced away from all metal parts and panels
  - All safety grounds (both internal and external) are correctly and securely connected
  - All panels are properly and securely reassembled

## ATTENTION!!!

This service manual is intended for use by persons having electrical and mechanical training and a level of knowledge of these subjects generally considered acceptable in the appliance repair trade. Electrolux Home Products cannot be responsible, nor assume any liability, for injury or damage of any kind arising from the use of this manual.

## TABLE OF CONTENTS

Safe servicing practices	2
Quick reference sheet	10
Maximum allowable surface temperatures	11
<b>SECTION A - INSTALLATION</b>	<b>12 - 17</b>
Clearances and dimensions	12
Important safety instructions	13
Tools you will need	13
Normal installation steps	13
Anti-tip bracket installation instructions	13
Electrical connection requirements	14
Grounding instructions	16
Model and serial number location	17
<b>SECTION B - SURFACE ELEMENT CONTROL SYSTEM</b>	<b>18 - 23</b>
Standard Infinite Switch	18 - 19
Troubleshooting	18 - 19
Element does not heat	18
Element does not cycle	19
Indicator light does not glow	19
Indicator light glows full brilliance with all switches off	19
Dual Infinite Switch	19 - 20
Troubleshooting	19 - 20
Both elements do not heat	20
Outer element doesn't heat, but inner element does	20
Inner element doesn't heat, but outer element does	20
Elements do not cycle	20
Indicator light does not glow	20
Indicator light glows full brilliance with all switches off	20
Top Element Electronic Control System	21 - 24
Components of the system	21
How it operates	22
Troubleshooting	22 - 24
F5 code	22
F6 code	23
F7 code	23
Blank display	23
Element not heating	23
Warm and Serve Zone	24
Troubleshooting	24
Element does not heat	24
Element does not cycle	25
Indicator light does not glow	25
Indicator light glows full brilliance with switch turned off	25
<b>SECTION C - ELECTRONIC OVEN CONTROL SYSTEMS</b>	<b>26 - 66</b>
The ES 100 Electronic Oven Control System	26 - 29
How to program the ES 100	26 - 27
To set the clock	26
To set the minute timer	26
To change the minute timer while it is in use	26
To cancel the minute timer before the set time has run out	26
To set the controls for baking	26
To change the oven temperature after baking has started	27

To broil	27
How the ES 100 operates	27
Bake	27
Broil	27
Calibration	28
The control cannot be calibrated	28
Troubleshooting	28 - 29
F1 code	28
F3 code	28
Control will not program	28
Control will not program	28
Blank Display	28
No heat	28
Bake element does not heat	28
Broil element does not heat	28
Sample schematic for ES100 control system	30
The ES 200 Electronic Oven Control System	31 - 36
How to program the ES 200	31 - 33
Temperature conversion	31
To change the temperature from °F to °C or from °C to °F	31
To set the clock	31
To set the minute timer	31
To change the minute timer while it is in use	32
To cancel the minute timer before the set time has run out	32
To set the controls for baking	32
To change the oven temperature after baking has started	32
To set control for continuous baking	32
To set control for oven lockout feature	32
To broil	32
To set the controls for a self-clean cycle	33
When the self-clean cycle is completed	33
Stopping or interrupting a self-cleaning cycle	33
How the ES 200 operates	33 - 34
Bake	33
Broil	34
Clean	34
Calibration	34
To change the calibration	34
Troubleshooting	34 - 36
F1 code	34
F3 code	34
F9 code	35
Control will not program	35
Blank display	35
Bake element does not heat	35
Broil element does not heat	35
Oven door does not lock when the oven is programmed for clean	35
Oven door locks but the oven does not heat	36
Lock motor runs continuously	36
Door latch is partly closed with door open	36
Sample schematic for ES200 control system	37
The ES 300 Electronic Oven Control System	38 - 45
How to program the ES 300	38 - 45
For a silent control panel	38
To change the temperature from °F to °C or from °C to °F	38
To set the clock	38
To set the minute timer	38

To change the minute timer while it is in use _____	39
To cancel the minute timer before the set time has run out _____	39
To set the controls for baking _____	39
To change the oven temperature after baking has started _____	39
To set control for continuous baking _____	39
To set control for oven lockout feature _____	39
To program the oven to begin baking immediately and to shut off automatically _____	39
To program oven for a delayed start time and to shut-off automatically _____	40
When the set bake time runs out _____	40
To change the oven temperature or bake time after baking has started _____	40
Speed Bake™ _____	40
To set speed bake cooking system _____	41
To broil _____	41
To set the controls for a self-clean cycle _____	41
When the self-clean cycle is completed _____	42
Stopping or interrupting a self-cleaning cycle _____	42
How the ES 300 operates _____	42 - 45
Bake _____	42
Time bake _____	43
Speed bake _____	43
Broil _____	43
Clean _____	43
Calibration _____	43
To change the calibration _____	43
Troubleshooting _____	44 - 45
F1 code _____	44
F3 code _____	44
F9 code _____	44
Control will not program _____	44
Time bake does not operate _____	44
Blank display _____	44
Bake element does not heat _____	44
Broil element does not heat _____	45
Oven door does not lock when the oven is programmed for clean _____	45
Oven door locks but the oven does not heat _____	45
Lock motor runs continuously _____	45
Door latch is partly closed with door open _____	45
Fan in oven does not run when speed bake switch is turned on _____	45
Sample schematic for ES300 control system _____	46
The ES 400 Electronic Oven Control System _____	47 - 55
How to program the ES 400 _____	47 - 52
Clock _____	47
To set the clock _____	47
Changing between 12 or 24 hour time of day display _____	47
Continuous bake or 12 hour energy saving _____	47
To set the control for continuous bake or 12 hour energy saving _____	47
Minute timer _____	48
To set the minute timer _____	48
To change the minute timer while it is in use _____	48
To cancel the minute timer before the set time has run out _____	48
Oven lockout feature _____	48
To activate the oven lockout _____	48
To reactivate oven operation _____	48
Temperature display - Fahrenheit or Celsius _____	48

To change the temperature from °F to °C or from °C to °F	48
Silent control operation	48
To change control from normal sound operation to silent control operation	48
Preheat	49
To set preheat temperature	49
To change the preheat temperature while the oven is preheating	49
Bake	49
To set the bake temperature	49
To change the bake temperature	49
Timed bake	49
To program the oven to begin baking immediately and to shut off automatically	49
Delay timed bake- cook time and stop time	50
To program oven for a delayed start time and to shut-off automatically	50
To broil	50
To set the oven to broil	50
Convection bake	51
To set the convection bake feature	51
Convection roast	51
To set the convection roast feature	51
Self-clean cycle	51
To set the controls for the self-cleaning cycle to start immediately and shut off automatically	51
When the self-clean cycle is completed	52
Stopping or interrupting a self-cleaning cycle	52
How the ES 400 operates	52 - 53
Preheat	52
Bake	52
Time bake	52
Convection bake	52
Convection roast	53
Broil	53
Clean	53
Calibration	53
To change the calibration	53
To adjust the oven temperature higher	53
To adjust the oven temperature lower	53
Troubleshooting	53 - 55
F1 code	53
F3 code	53
F9 code	54
Control will not program	54
Time bake does not operate	54
Convection bake and convection roast	54
Neither the fan motor or the assist element operates	54
If either the convection bake or roast operates normal but the other does not	54
Fan motor does not operate	54
Assist element does not operate	54
Control does not operate in preheat	54
Blank Display	54
Bake element does not heat	54
Broil element does not heat	55
Oven door does not lock when the oven is programmed for clean	55
Lock motor runs continuously	55

Oven door locks but the oven does not heat	55
Door latch is partly closed with door open	55
Sample schematic for ES400 control system	56
The ES 450 Electronic Oven Control System	57 - 66
How to program the ES 450	57 - 62
Clock	57
To set the clock	57
Changing between 12 or 24 hour time of day display	57
Continuous bake or 12 hour energy saving	57
To set the control for continuous bake or 12 hour energy saving	57
Minute timer	58
To set the minute timer	58
To change the minute timer while it is in use	58
To cancel the minute timer before the set time has run out	58
Oven lockout feature	58
To activate the oven lockout	58
To reactivate oven operation	58
Temperature display - Fahrenheit or Celsius	58
To change the temperature from °F to °C or from °C to °F	58
Silent control operation	58
To change control from normal sound operation to silent control operation	58
Preheat	59
To set preheat temperature	59
To change the preheat temperature while the oven is preheating	59
Bake	59
To set the bake temperature	59
To change the bake temperature	59
Timed bake	59
To program the oven to begin baking immediately and to shut off automatically	59
Delay timed bake- cook time and stop time	60
To program oven for a delayed start time and to shut-off automatically	60
To broil	60
To set the oven to broil	60
Convection bake	61
To set the convection bake feature	61
Setting food categories feature	61
To set the food categories feature	61
Self-clean cycle	61
To set the controls for the self-cleaning cycle to start immediately and shut off automatically	62
When the self-clean cycle is completed	62
Stopping or interrupting a self-cleaning cycle	62
How the ES 450 operates	62 - 64
Preheat	62
Bake	62
Time bake	62
Convection bake	63
Fixed settings	63
Meats	63
Cakes	63
Breads	63
Broil	63
Clean	63
Calibration	63

To change the calibration	63
To adjust the oven temperature higher	63
To adjust the oven temperature lower	63
Troubleshooting	64 - 65
F1 code	64
F3 code	64
F9 code	64
Control will not program	64
Time bake does not operate	64
Convection bake	64
Neither the fan motor or the assist element operates	64
Fan motor does not operate	64
Assist element does not operate	64
Control does not operate in preheat	64
Blank Display	65
Bake element does not heat	65
Broil element does not heat	65
Oven door does not lock when the oven is programmed for clean	65
Lock motor runs continuously	65
Oven door locks but the oven does not heat	65
Door latch is partly closed with door open	65
Sample schematic for ES450 control system	66
Warmer drawer	67 - 68
To set the warmer drawer thermostat control	67
How the warmer drawer circuit works	67
Troubleshooting	67 - 68
Element does not heat	67
If the element heats during preheat, then stays off until the temperature drops to about 130° F	68
If the element does not cycle off	68
If the warmer drawer is slow preheating	68
If the warmer drawer heats, but the indicator light does not glow	68
<b>SECTION D - DISASSEMBLY AND REPLACEMENT OF PARTS</b>	<b>69 - 86</b>
Backguard	69 - 73
To remove the backguard back panel	69
To remove the infinite switches	69
To remove the knobs	69
To remove the potentiometers	69
To remove the user interface board	70
To remove the display window	70
To remove the top elements indicator light	71
To remove the electronic oven control	71
To remove the oven light switch	71
To remove the control panel	71
To remove the end caps	71
To remove the splasher panel	72
Main Top Area	73 - 76
To remove the main top with coil elements	73
To remove the main top on smooth top ranges	74
To remove the main top hinges	75
Top elements	75
To remove coil elements	75
To remove smooth top elements	75
To remove and replace terminal blocks for coil elements	76
To remove the lift and lock rods	76



To remove burner pan (coil element ranges only) _____	76
Oven door _____	76 - 78
To remove oven door seal _____	76
To remove oven door _____	77
Door hinge adjustment _____	77
Removal of the hinge opening cover _____	77
Door hinge removal _____	77
Oven door disassembly _____	77 - 78
Removing the upper door trim _____	77
Door handle _____	78
Outer door glass and trim _____	78
Center glass _____	78
Wool shield _____	78
Glass package and inner door liner _____	78
Components inside the oven _____	78 - 80
Bake element _____	78
Broil element _____	79
Fan blade (convection/speed bake models) _____	79
Convection assist element removal _____	79
Oven vent (coil element models) _____	79
Oven vent (smooth top models) _____	80
Removing the oven light cover (self-clean models) _____	80
Door latch removal (self-clean) _____	81
Door switch and rod removal (self-clean) _____	81
Components mounted to the back of the range _____	81 - 83
Removing the back cover _____	81
Removing lock motor assembly _____	81
Removing convection and speed bake motor assemblies _____	82
Removing oven sensor _____	82
Removing oven light socket _____	83
Removing mother board _____	83
Removing the bodyside panels _____	83
Storage drawer _____	84
Removing the storage drawer front panel _____	84
Removing inside drawer panel _____	84
Removing storage drawer glides _____	84
Removing the bottom heat shield _____	85
Removing bottom wool shield _____	85
Warmer drawer area _____	85
Removing the warmer drawer _____	85
Removing the warmer drawer side rail _____	85
Removing drawer rail from range frame _____	86
Removing warmer drawer low limit thermostat _____	86
Removing the warmer drawer element _____	86

**Quick reference sheet**

1. Serial number breakdown:

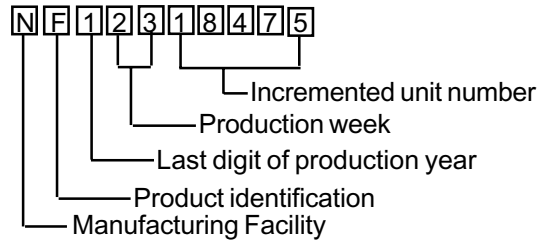

2. Oven sensor resistance chart:

RTD	SCALE
Temperature Degrees F.	Resistance (Ohms)
32 +/- 1.9	1000 +/- 4.0
75 +/- 2.5	1091 +/- 5.3
250 +/- 4.4	1453 +/- 8.9
350 +/- 5.4	1654 +/- 10.8
450 +/- 6.9	1852 +/- 13.5
550 +/- 8.2	2047 +/- 15.8
650 +/- 9.6	2237 +/- 18.5
900 +/- 13.6	2697 +/- 24.4

3. Element resistance

The wattage rating is stamped on the element. To determine the resistance divide the wattage by the voltage rating on the element (either 250 or 120) to obtain the amperage. Then divide the amperage into the voltage rating to obtain the resistance. If for some reason you cannot find the wattage rating, as a general rule most element's resistance will be between 15 and 45 Ohms.

**Maximum allowable surface temperatures for gas & electric cooking products:**

When Frigidaire tests side panels and doors for surface temperature, certain U.L. and/or A.G.A. guide lines must be followed.

1. Product must be undamaged, correctly assembled and have the correct oven test temperature.
2. All surface temperatures are based on a room temperature of 77° F (25° C) and an oven set temperature of 400° F.
3. Oven must be cycling at 400° F for one hour before test is conducted.
4. Pyrometers (temperature testers) must be of high quality and properly adjusted.
5. An increase or decrease of 1° F in the room ambient temperature will allow a 1° F increase or decrease in the maximum allowable surface temperature of the range.

Side Panel, Painted 152° F

Side Panel, Porcelain 160° F

Oven Door, Glass 172° F

Oven Door, Painted 152° F

Oven Door, Porcelain 160° F

Warmer Drawer, Painted 152° F

Warmer Drawer, Porcelain 160° F

Cooktop, No Temperature Limits Apply

Lower Console, No Temperature Limits Apply

Oven Vent Area, No Temperature Limits Apply

	Knobs and Handles		Skirt	
	Plastic*	Metal	Plastic*	Metal
Conventional Gas & Electric	167° F	131° F	182° F	152° F
Self-Clean Gas at Clean Temperature	167° F	131° F	182° F	152° F
Self-Clean Gas at Clean Temperature	182° F	152° F	182° F	152° F

\* Includes plastic with metal plating not more than 0.005" thick and metal with a plastic or vinyl covering not less than 0.005" thick

## SECTION A - INSTALLATION

**INSTALLATION AND SERVICE MUST BE PERFORMED BY A QUALIFIED INSTALLER. IMPORTANT: SAVE FOR LOCAL ELECTRICAL INSPECTOR'S USE.**

### Clearances and Dimensions

1. **Provide adequate clearances between the range and adjacent combustible surfaces.**
2. **Location**—Check location where the range will be installed. Check for proper electrical supply, and the stability of the floor.
3. **Dimensions that are shown must be used.** Given dimensions provide minimum clearance. Contact surface must be solid and level.

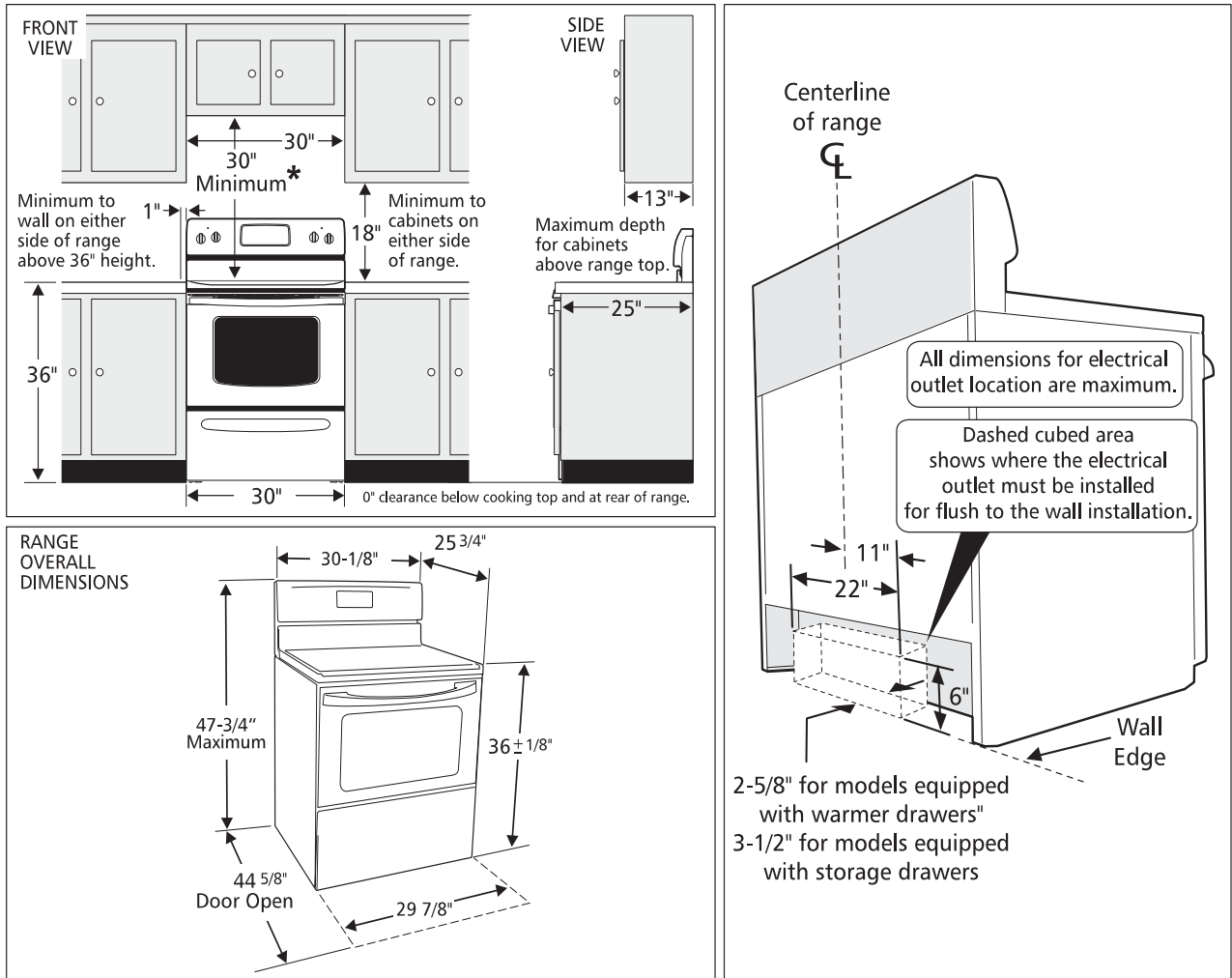

\*30" MINIMUM CLEARANCE BETWEEN THE TOP OF THE COOKING SURFACE AND THE BOTTOM OF AN UNPROTECTED WOOD OR METAL CABINET; OR 24" MINIMUM WHEN BOTTOM OF WOOD OR METAL CABINET IS PROTECTED BY NOT LESS THAN 1/4" FLAME RETARDANT MILLBOARD COVERED WITH NOT LESS THAN NO. 28 MSG SHEET STEEL, 0.015" STAINLESS STEEL, 0.024" ALUMINUM OR 0.020" COPPER. 0" CLEARANCE IS THE MINIMUM FOR THE REAR OF THE RANGE. FOLLOW ALL DIMENSION REQUIREMENTS PROVIDED ABOVE TO PREVENT PROPERTY DAMAGE, POTENTIAL FIRE HAZARD, AND INCORRECT COUNTERTOP AND CABINET CUTS.

**TO ELIMINATE THE RISK OF BURNS OR FIRE BY REACHING OVER HEATED SURFACE UNITS, CABINET STORAGE SPACE LOCATED ABOVE THE SURFACE UNITS SHOULD BE AVOIDED. IF CABINET STORAGE IS TO BE PROVIDED, THE RISK CAN BE REDUCED BY INSTALLING A RANGE HOOD THAT PROJECTS HORIZONTALLY A MINIMUM OF 5" BEYOND THE BOTTOM OF THE CABINETS.**

## IMPORTANT SAFETY INSTRUCTIONS

**WARNING:** If the information in this manual is not followed exactly, a fire or electrical shock may result causing property damage, personal injury or death.



### Important Notes to the Installer

1. Read all instructions contained in these installation instructions before installing range.
2. Remove all packing material from the oven compartments before connecting the gas and electrical supply to the range.
3. Observe all governing codes and ordinances.
4. Be sure to leave these instructions with the consumer.

### Important Note to the Consumer

Keep these instructions with your owner's guide for future reference.

- As when using any appliance generating heat, there are certain safety precautions you should follow. These are listed in the Use & Care Manual, read it carefully.
- Be sure your range is installed and grounded properly by a qualified installer or service technician.
- Make sure the wall coverings around the range can withstand the heat generated by the range.
- To eliminate the need to reach over the surface elements, cabinet storage space above the elements should be avoided.

### Before Starting - Tools You Will Need:

For leveling legs and Anti-Tip Bracket:

- Adjustable wrench or channel lock pliers

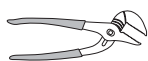

- 5/16" Nutdriver or Flat Head Screwdriver



- Electric Drill & 1/8" Diameter Drill Bit (Masonry Drill Bit if installing in concrete)

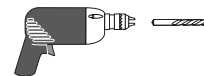

For electrical supply connection:

- 1/4" & 3/8" Socket driver or Nutdriver



### Additional Materials You Will Need

- Power Supply Cord or 
- Copper Electrical Wiring & Metal Conduit (for hard wiring)

### Normal Installation Steps

#### 1. Anti-Tip Bracket Installation Instructions

**Important Safety Warning - To reduce the risk of tipping of the range, the range must be secured to the floor by properly installed anti-tip bracket and screws packed with the range. Failure to install the anti-tip bracket will allow the range to tip over if excessive weight is placed on an open door or if a child climbs upon it. Serious injury might result from spilled hot liquids or from the range itself.**

**If range is ever moved to a different location, the anti-tip brackets must also be moved and installed with the range.**

**Instructions are provided for installation in wood or cement fastened to either the floor or wall. When installed to the wall, make sure that screws completely penetrate dry wall and are secured in wood or metal. When fastening to the floor or wall, be sure that screws do not penetrate electrical wiring or plumbing.**

**A. Locate the Bracket Using the Template** - (Bracket may be located on either the left or right side of the range. Use the information below to locate the bracket if template is not available). Mark the floor or wall where left or right side of the range will be located. If rear of range is against the wall or no further than 1-1/4" from wall when installed, you may use the wall or floor mount method. If molding is installed and does not allow the bracket to fit flush against the wall, remove molding or mount bracket

to the floor. For wall mount, locate the bracket by placing the back edge of the template against the rear wall and the side edge of template on the mark made referencing the side of the range. Place bracket on top of template and mark location of the screw holes in wall. If rear of range is further than 1-1/4" from the wall when installed, attach bracket to the floor. For floor mount, locate the bracket by placing back edge of the template where the rear of the range will be located. Mark the location of the screw holes shown in template.

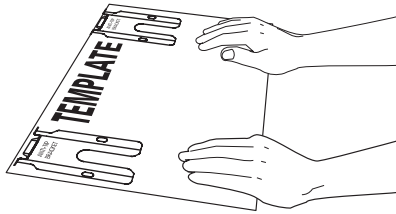

- B. Drill Pilot Holes and Fasten Bracket** - Drill a 1/8" pilot hole where screws are to be located. If bracket is to be mounted to the wall, drill pilot hole at an approximate 20° downward angle. If bracket is to be mounted to masonry or ceramic floors, drill a 5/32" pilot hole 1-3/4" deep. The screws provided may be used in wood or concrete material. Use a 5/16" nut-driver or flat head screwdriver to secure the bracket in place.

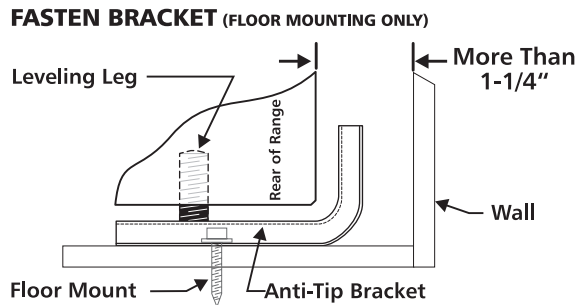
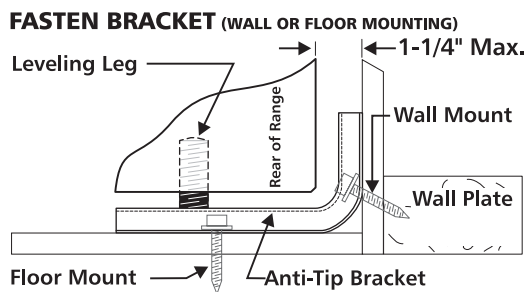

- C. Level and Position Range** - Level range by adjusting the (4) leveling legs with a wrench. Note: A minimum clearance of 1/8" is required between

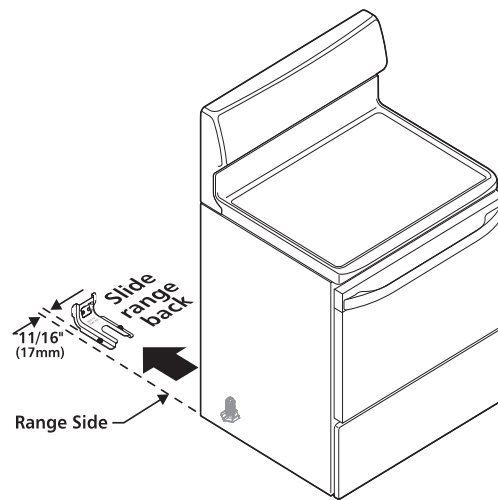

the bottom of the range and the leveling leg to allow room for the bracket. Use a spirit level to check your adjustments. Slide range back into position. Visually check that rear leveling leg is inserted into and fully secured by the Anti-Tip Bracket by removing lower panel or storage drawer. For models with a warmer drawer or broiler compartment, grasp the top rear edge of the range and carefully attempt to tilt it forward.

## 2. Electrical Connection Requirements

This appliance must be properly installed and grounded by a qualified technician in accordance with the National Electrical Code ANSI/NFPA No. 70--latest edition--and local electrical code requirements.

This appliance may be connected by means of permanent "Hard Wiring" or "Power Supply Cord Kit."

When hard wiring, do not leave excess wire in range compartment. Excess wire in the range compartment may not allow the access cover to be replaced properly, and could create a potential electrical hazard if wires become pinched. Connect only as instructed under "WIRING INSTRUCTIONS" in section 4A or 4B. When using flexible conduit or range cable use flex connector or range cable strain relief.

**NOTE:** Only use copper wire in connection to terminal block.

### 2A. Models with Factory Connected Power Supply Cord

**NOTE:** Some models may be equipped with a factory connected three (3) conductor power supply cord.

Mobile home installations, new branch circuit installations (1996NEC) or areas where local codes do not permit grounding through neutral require a four (4) conductor power supply cord kit rated at 125/250 volts minimum and marked for use with ranges. See Range Connection Opening Size Chart for cord kit ampere rating information. Terminals on end of wires must be either closed loop or open-end spade lugs with upturned ends.

## 2B. Models Requiring Power Supply Cord Kit

**RISK OF FIRE OR ELECTRICAL SHOCK MAY OCCUR IF AN INCORRECT SIZE RANGE CORD KIT IS USED, THE INSTALLATION INSTRUCTIONS ARE NOT FOLLOWED OR STRAIN RELIEF BRACKET IS DISCARDED.**

This appliance may be connected by means of a power supply cord. Only a power supply cord kit rated at 125/250 volts minimum, and marked for use with ranges shall be used. See chart on page 3 for cord kit ampere rating information. Cord must have either three (3) or four (4) conductors. Terminals on end of wires must be either closed loop or open-end spade lugs with upturned ends. Cord must have strain relief clamp.

See section 4A for 3-wire or section 4B for 4-wire connection.

## 3. Electrical Connection to Range

The rear access cover must be removed. To remove, loosen center screw (one screw) and remove access cover. The terminal block will then be accessible.

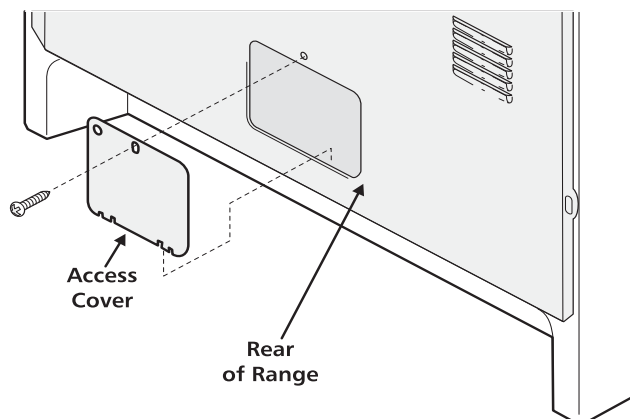

Access Cover

Range Connection Opening Size Chart			
Supply Cord Kit ampere rating information. See serial plate on Range for kilowatt rating data.			
See Serial Plate on Range for KW Rating	Cord Kit Ampere Rating	Diameter (in.) of Range Connection Opening	
		Cord Kit	Permanent Wiring
120/240 Volts 120/208 Volts			
8.8-16.5 KW/7.9-12.5 KW 16.6-22.5 KW/12.6-18.5 KW	40/50 Amp	1-3/8 in. 1-3/8 in.	1-1/8 in. 1-3/8 in.

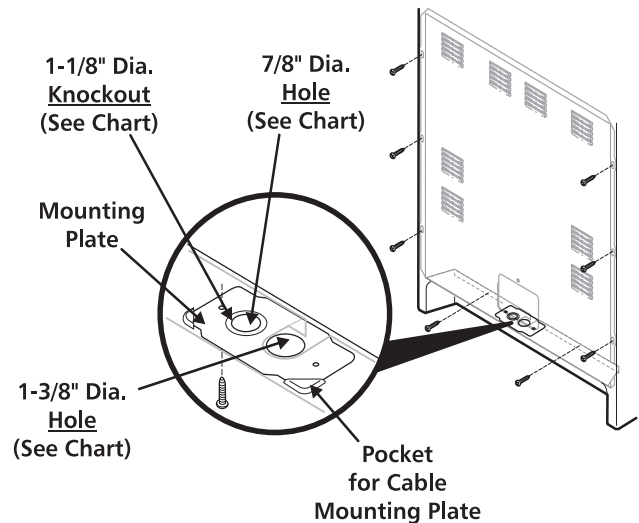

**NOTE:** Range is shipped from factory with 1-3/8" dia. hole as shown. To use either 7/8" dia. hole or 1-1/8" dia. knockouts:

**If a different diameter hole is required, please follow the steps below:**

1. Using a 1/4" socket driver, remove eight (8) screws from Rear Wall Shield to release from the unit (as shown). Save the screws for step 7 below.
2. Again using the 1/4" socket driver, remove one (1) blunt point screw used to secure the Cable Mounting Plate to the Rear Wall Shield. Save the screw for step 6.
3. Remove the Cable Mounting Plate from the Rear Wall Shield by sliding the plate out of the pockets.
4. If a 1-1/8" dia. hole is required, "punch-out" the knockout.
5. Rotate the plate 180 degrees so that the desired hole is placed on top of the opening located on the bottom flange of the Rear Wall Shield.

- Slide the Cable Mounting Plate into the Rear Wall Shield. Re-secure using the blunt point screw removed from step #2 above.
- Reassemble the Rear Wall Shield to the unit using eight (8) screws removed from step #1 above.

#### 4A. Wiring Instructions (3-Wire Connection)

- Remove the three (3) loose nuts on the terminal block using a 3/8" nut driver or socket.

**NOTE:** Do not loosen the nuts which secure the factory installed range wiring to the terminal block. Electrical failure or loss of electrical connection may occur if nuts are loosened.

- Using the nuts removed in step 1, connect the cable or copper power supply cord to the three (3) studs on the terminal block, as local codes require. The neutral (white) wire or center wire must be connected to the center terminal.
- Make sure all nuts are tightened securely.
- Replace the rear access cover

### 3-Wire Connection

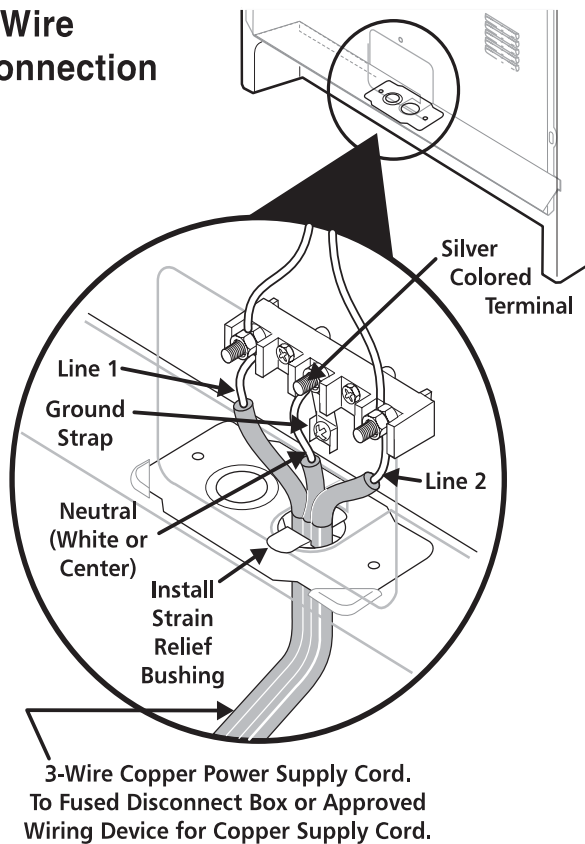

#### GROUNDING INSTRUCTIONS:

A ground strap is installed on this range which connects the center terminal of the terminal block (neutral) to the chassis. The ground strap is shown in the 3-wire connection picture below and is connected to the range by the center, lowest screw. The ground link must not be removed unless national or local codes do not permit use of ground strap.

**NOTE:** If the ground strap is removed for any reason, a separate ground wire must be connected to the separate ground screw attached to the range chassis and to an adequate ground source.

#### 4B. Wiring Instructions (4-Wire Connection)

If connecting to a 4-wire electrical system (new branch-circuit or mobile home requires 4 wire connection):

- Remove the three (3) loose nuts on the terminal block using a 3/8" nut driver or socket. From the center stud on the terminal block, remove the second nut and the copper ground strap. Replace the nut that held the ground strap to the terminal block.

**NOTE:** Do not loosen the second nut on line 1 or line 2 which secure the factory installed range wiring to the terminal block. Electrical failure or loss of electrical connection may occur if nuts are loosened.

- Remove the ground screw to release the copper ground strap from the appliance.
- Discard the ground strap. Connect the ground wire (green) of the copper power supply cord to the frame of the appliance with the ground screw, using the same hole in the frame where the ground strap was removed.
- Using the nuts removed in step 1, connect the neutral (white) wire of the copper power supply cord to the center silver colored stud on the terminal block.
- Connect the final two (2) wires to the outer studs on the terminal block.
- Make sure all nuts are tightened securely.
- Replace the rear access cover.



## 4-Wire Connection

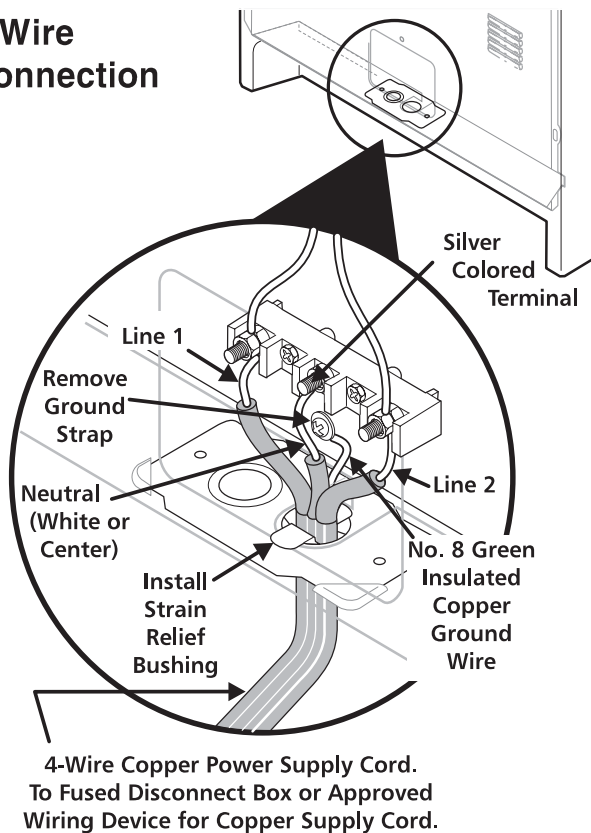

## Before You Call for Service

Read the "Before You Call" and operating instruction sections in your Use & Care Manual. It may save you time and expense. The list includes common occurrences that are not the result of defective workmanship or materials in this appliance.

Refer to the warranty in your Use & Care Manual for our toll-free service number and address. Please call or write if you have inquiries about your range product and/or need to order parts.

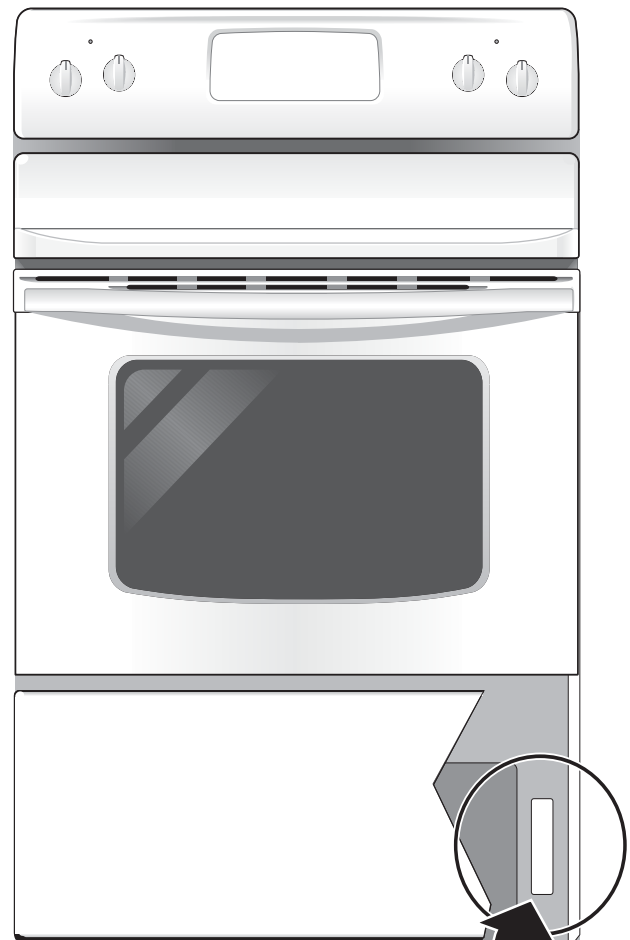

Serial plate location  
Open storage or warmer drawer,  
or remove lower panel  
(on some models)

## Model and Serial Number Location

The serial plate is located on the right-hand surface of the oven front frame at the storage or warmer drawer; or the lower panel area.

When ordering parts for or making inquiries about your range, always be sure to include the model and serial numbers and a lot number or letter from the serial plate on your range.

Your serial plate also tells you the Kilowatt rating (power requirements) and Voltage ratings

## Care, Cleaning and Maintenance

Refer to the Use & Care Manual for cleaning instructions.

If removing the range is necessary for cleaning or maintenance, disconnect the electrical power supply. If the electrical supply is inaccessible, lift the unit slightly at the front and pull out away from the wall. Pull only as far as necessary to disconnect the electrical supply. Finish removing the unit for servicing and cleaning. Reinstall in reverse order making sure to level the range and check electrical connections. See pages 13 and 14 for proper anchoring instructions.

## SECTION B - SURFACE ELEMENT CONTROL SYSTEMS

Three types of surface elements control systems are covered in this manual.

1. Standard infinite switch.
2. Dual infinite switch.
3. Electronic top element system. (ESEC 5)

### Standard infinite switch:

The surface elements and standard infinite switches provide an infinite choice of heat settings for cooking. Controls are safety type and must be pushed in before turning. All surface controls are marked on the control panel for their respective heating element. Power is supplied to the surface elements through the infinite switch contacts L1-H1 and L2-H2. During actual surface element operation, if the control is set to the high position contacts L2-H2 are lock closed providing continuous power to the element. In all other setting contacts L2-H2 will cycle to maintain the correct heat setting. Contacts L1-P provide power to the surface element indicator light.

### Troubleshooting:

There are four ways a surface control system with a standard infinite switch can fail.

1. The element does not heat.
2. The switch does not cycle the element off and on when set to a position other than high.
3. The element operates correctly, but the indicator light does not glow.
4. Indicator light glows with all infinite switches in the off position.

**NOTE:** If the indicator light glows very dimly with all the switches in the off position. This problem is caused by a capacitive feed over in the wiring and can be corrected by connecting a 100,000 Ohm 1/4 watt resistor in parallel with the light.

Continuity tests can be performed on the infinite switch contacts. All tests should be performed with power to the range disconnected, and wiring removed from the switch. Set an ohmmeter on R X 1K scale and check the contacts in the following chart and switch terminal diagram.

Contacts	Dial Position		
	OFF	LO-MED	HI
L1 - P	O	X	X
L1 - H1	O	X	X
L2 - H2	O	X - C	X

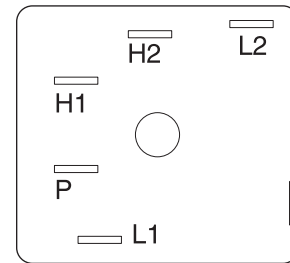

### Element does not heat:

Checking the system with a Voltmeter, if the element does not heat up.

1. Remove the back of the control panel to expose the switch terminals.
  2. With a Voltmeter set for AC on a scale higher than 240 Volts measure the voltage drop between terminals L1 and L2. If the meter reads zero the wiring between the main terminal block on the range and the switch is open. If the meter reads line to line voltage (around 240 VAC) go to step 3.
  3. With the switch turned to the high position measure the voltage drop between terminals H1 and H2. If the meter reads zero the switch is defective. If the meter reads line to line voltage the switch is good. If the range has standard elements go to step 4. If the range has a glass smooth go to step 5.
  4. Remove the element and measure the voltage drop between terminals of the terminal block. If the meter reads zero the terminal block or the wiring between the switch and the terminal block is open. If the meter reads line to line voltage the element is defective.
- NOTE:** Always inspect the terminal block for burnt spots that can cause poor connection.
5. Raise the top and locate the two terminals on the element that the wires from H1 and H2 are on. Measure the voltage drop between the two terminals. If the meter reads zero the wires

between the switch and the element are open. If the meter reads line to line voltage the element is defective.

**Element does not cycle:**

If the element does not cycle when the switch is set in a position other than high the switch is defective.

**Indicator light does not glow:**

If indicator light does not glow when the switch is turned on, remove the back panel of the backguard, turn the switch on, and measure the voltage drop between terminals P and L2. If the meter reads zero the switch is defective. If the meter reads line to line voltage (around 240 VAC) the light or the wiring to the light is defective.

**Indicator light glows full brilliance with all top element switches off:**

If indicator light glows full brilliance with all top element switches off, one or more of the switches are defective. Disconnect electrical power from the range, and remove the back panel of the backguard. Disconnect the wire from the P terminal on all switches but one switch. Reconnect power. If the indicator light glows with the switch in the off position, the switch is defective. If the indicator light does not glow, the switch is good. Check each switch by disconnecting the wires from all the other P terminals but the switch you are testing.

**Dual infinite switch:**

The dual infinite switch is used to control the expandable and bridge elements on electric smooth top ranges. The dual infinite switches provide an infinite choice of heat settings for cooking, and two selection of element sizes. Controls are safety type and must be pushed in before turning. All surface controls are marked on the control panel for their respective heating element.

When the knob is turned clockwise, less than 180 degrees, contacts P2 to 4, P2 to 4A, and P1 to 2 closes

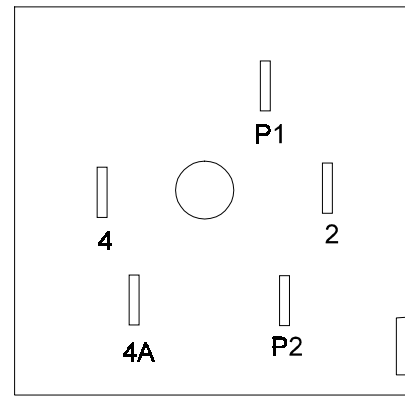
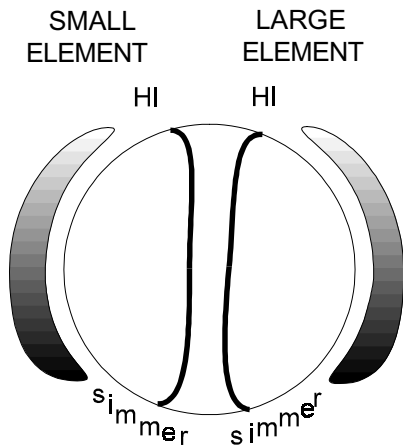

providing power to both elements. When the knob is turned counterclockwise, less than 180 degrees, contacts P2 to 4 and P1 to 2 close providing power to the inner element. During actual surface element operation, if the control is set to the high position contacts P1 to 2 are locked closed providing continuous power to the element. In all other settings contacts P1 to 2 will cycle to maintain the correct heat setting. Contact 4 to L2 provides power to the surface element indicator light.

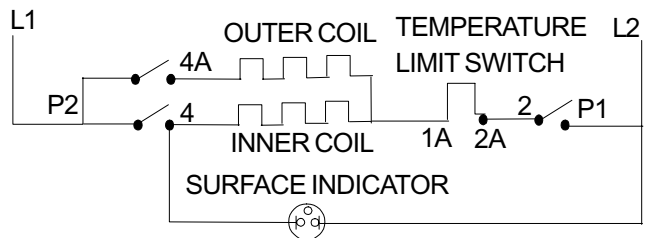

**Troubleshooting:**

There are six ways a surface control system with a dual infinite switch can fail.

1. Both elements do not heat.
2. The outer element does not heat.
3. The inner element does not heat.
4. The switch does not cycle the element off and on when set to a position other than high.
5. The element operates correctly, but the indicator light does not glow.
6. Indicator light glows with all the infinite switches in the off position.

**NOTE:** If the indicator light glows very dimly with all the switches in the off position. This problem is caused by a capacitive feed over in the wiring and can be corrected by connecting a 100,000 Ohm 1/4 watt resistor in parallel with the light.

**Both elements do not heat:**

Checking the system with a Voltmeter, if the elements do not heat up:

1. Remove the back panel of the backguard to expose the switch terminals.
2. With a Voltmeter set for AC and a scale higher than 240 Volts measure the voltage drop between terminals P1 and P2. If the meter reads zero the wiring between the main terminal block on the range and the switch is open. If the meter reads line to line voltage (around 240 VAC) go to step 3.
3. With the switch turned clockwise to the HI position, measure the voltage drop between terminals 4 and 2. If the meter reads zero the switch is defective. If the meter reads line to line voltage measure the voltage drop between terminals 4A and 2. If the meter reads line to line voltage the switch is good. Go to step 4.
4. Raise the top and locate the two terminals on the element with the wires from terminals 4 and 2 are connected. Measure the voltage drop between these two terminals. If the meter reads zero the wires between the switch and the element are open. If the meter reads line to line voltage the element is defective.

**Outer element doesn't heat, but inner element does:**

Checking the system with a Voltmeter, if the outer element does not heat, but the inner element does:

1. Remove the back panel of the backguard to expose the switch terminals.
2. With the switch turned clockwise to the high position measure the voltage drop between terminals 4A and 2. If the meter reads zero the switch is defective. If the meter reads line to line voltage, go to step 3.
3. Raise the top and locate the two terminals on the element where the wires from terminals 4A and 2 are connected. Measure the voltage drop between these two terminals. If the meter reads zero the wires between the switch and the element are open. If the meter reads line to line voltage the element is defective.

**Inner element doesn't heat, but outer element does:**

Checking the system with a Voltmeter, if the inner element does not heat, but the outer element does:

1. Remove the back panel of the backguard to expose the switch terminals.

2. With the switch turned clockwise to the high position measure the voltage drop between terminals 4 and 2. If the meter reads zero the switch is defective. If the meter reads line to line voltage, go to step 3.
3. Raise the top and locate the two terminals on the element where the wires from terminals 4 and 2 are connected. Measure the voltage drop between these two terminals. If the meter reads zero the wires between the switch and the element are open. If the meter reads line to line voltage the element is defective.

**Elements do not cycle:**

If the elements do not cycle when the switch is set in a position other than high the switch is defective.

**Indicator light does not glow:**

If indicator light does not glow when the switch is turned on, remove the back panel of the backguard, turn the switch on, and measure the voltage drop between terminals 4 and L2. If the meter reads zero the switch is defective. If the meter reads line to line voltage (around 240VAC) the light or the wiring to the light is defective.

**Indicator light glows full brilliance with all top element switches off:**

If indicator light glows full brilliance with all top element switches off, one or more of switches are defective. Disconnect electrical power from the range, and remove the back panel of the backguard. Disconnect the wire from terminal 4 on the switches from all but one switch. Reconnect power. If the indicator light glows with the switch in the off position the switch is defective. If the indicator light does not glow the switch is good. Check each dual infinite switch by disconnecting the wires from all the other 4 terminals but the switch you are testing.

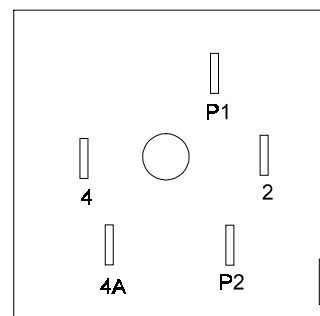
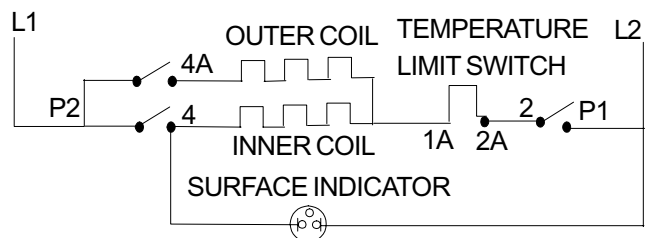

## Top Element Electronic Control System:

Some electric range models are equipped with electronic top element controls, these controls are more accurate and allow for a lower simmer temperature than the conventional infinite switches.

**CAUTION: ON MODELS WITH ELECTRONIC TOP ELEMENT CONTROLS, LINE 1 IS CONNECTED TO THE TOP ELEMENTS WHENEVER ELECTRICAL POWER IS APPLIED TO THE RANGE.**

### Components of the system:

The top element electronic control system (engineering named ESEC 5) is made up of five components; Potentiometers, User Interface Boards, Mother Board, Electronic Oven Control, and Top Elements.

1. Four potentiometers (variable resistors) - one for each top element, that the user changes the resistance of when they turn the knob. Because of the different types of elements two different potentiometers are used. A potentiometer with a resistance of 20,000 Ohms is used with the single element, and a potentiometer with a resistance of 10,000 Ohms is used with the dual and bridge elements. The potentiometers are identified by the color of their base. The 20,000 Ohm potentiometer has a gray base, the 10,000 Ohm potentiometer has a black base.

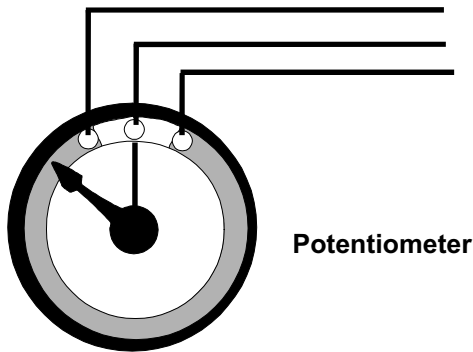

2. Two user interface boards (UIB) - one for each side of

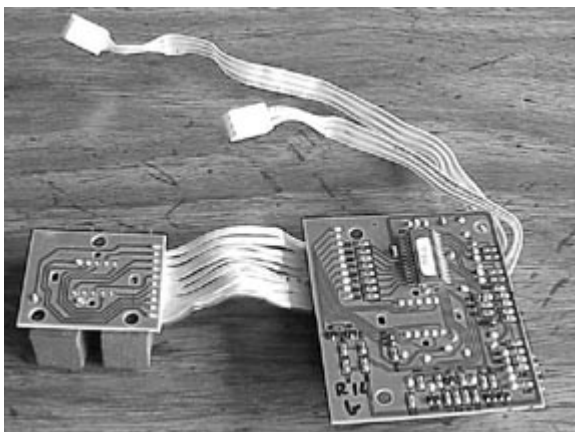

User Interface Board

the range, with four displays, one for each element that shows the setting of the control. These work as interfaces between potentiometers and the mother board.

3. One mother board - main circuit board that has a transformer to provide low voltage for the system, a microprocessor that controls and communicates with the other components of the system, and relays that control line to line voltage to the top elements.

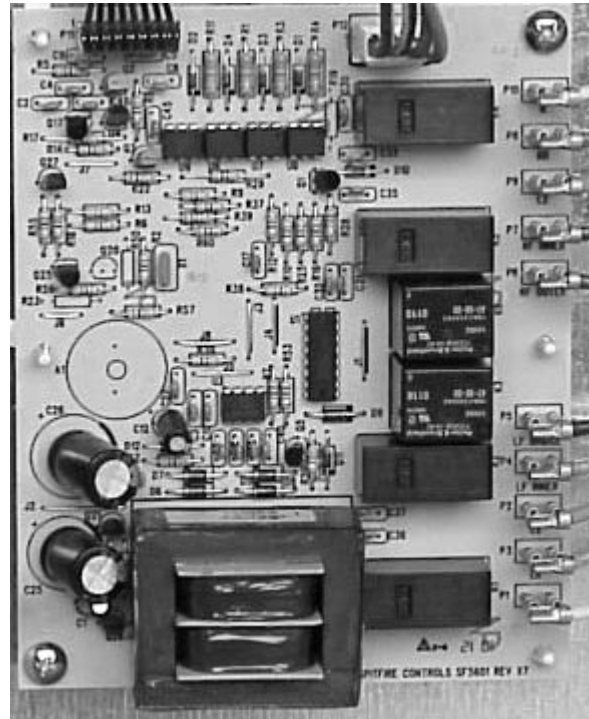

Mother Board

4. A section of the electronic oven control (EOC) - communicates with the mother board to allow a lockout feature on the EOC that prevents the oven or top elements from operating when activated. It also prevents the top elements from operating during a self clean cycle.

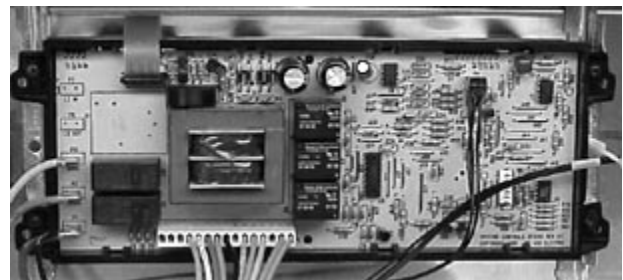

Electronic Oven Control

5. Top elements - three types are used; a single element, a dual element, and a bridge element.

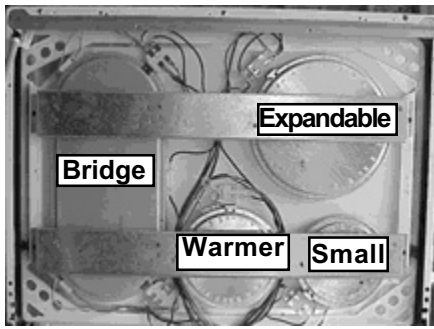

**Top elements**

**How it operates:**

Whenever the range is connected to electrical power, low voltage from the mother board is applied across the two outside pins of the potentiometers. The microprocessor then reads the resistance of the potentiometers. When the switch knob is depressed and turned the wipe arm attached to the center pin of the potentiometer is turned to a resistance range that the microprocessor can read. The microprocessor then compares these two readings and displays the setting in the UIB display window for that element. To prevent the microprocessor from reading a short or an open, a fixed resistance is connected to each end of the adjustable resistor internally. The 10,000 Ohm potentiometer has a 500 Ohm resistance on each end of the winding and the 20,000 Ohm potentiometer has a 1,000 Ohm resistance on each end of the winding.

The setting display in the UIB display window will read from Hi to Lo with numbers in between (see chart below). The microprocessor operates on a 15 second duty cycle. When the knob is turned to the HI position the mother board applies line to line voltage to the element all the time. In any other setting other than Hi the microprocessor will cycle line to line voltage to the element by opening and closing the relay on the mother board for that element.

Display Reading	% Of On Time	Display Reading	% Of On Time
Lo	1	4.0	35
1.0	2	4.5	40
1.2	3	5.0	45
1.4	4	5.5	50
1.6	5	6.0	60
1.8	6	6.5	70
2.0	8	7.0	75
2.2	10	7.5	80
2.4	12	8.0	85
2.6	15	8.5	90
2.8	20	9.0	95
3.0	25	Hi	100
3.5	30		

**NOTE:** On glass top ranges the element may cycle in the Hi position because of the limiter in the element that protects the glass.

**NOTE:** In the Lo position a 2500 watt element would be operating at 25 watts.

The display is also used as a hot surface indicator on glass top ranges. The mother board is connected to the hot surface contacts of the element's limiter. When the potentiometer is turned to the off position, and if the hot surface contacts of the limiter are closed the display will read HE for hot element until the element cools down and the hot surface contacts of the limiter opens.

**Troubleshooting the ESEC 5:**

The ESEC 5 has some self diagnostics built into the microprocessor to help in troubleshooting the system. When a failure occurs one of three codes will appear in all the display windows; F5, F6, or F7.

**F5 code:**

Indicates a harness, mother board, or user interface board has failed. The harness is the first thing to check, unplug the harness, inspect each connection and Ohm out the harness.

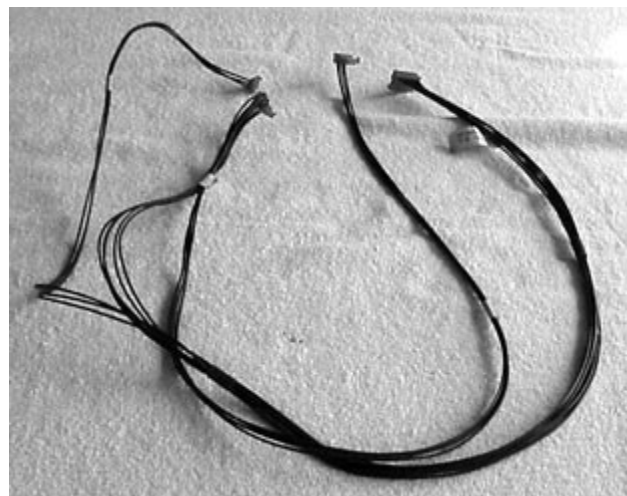
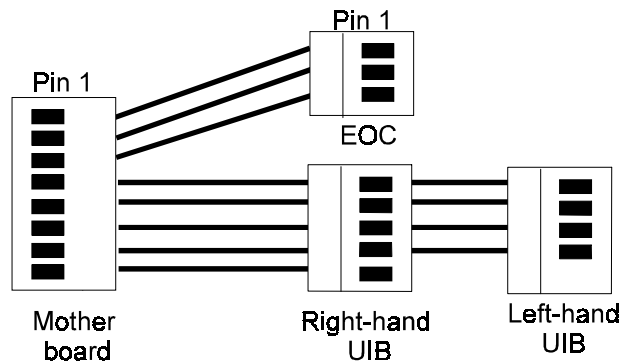

**Harness**

Reconnect the harness, if the F5 is still displayed, go to the right hand user interface board as viewed from the rear of the range. Notice that the harness to this board has four wires and five pins. Disconnect the harness plug from the board. With a voltmeter set to DC volts, using a scale that will measure up to sixteen volts, measure the voltage drop between pins one and two.

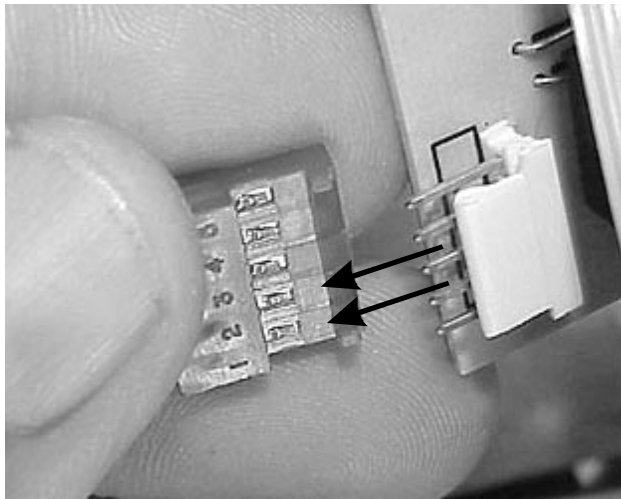

**Pins 1 & 2**

If the reading is between 4 VDC and 12 VDC the mother board is good. One at a time substitute a good user interface board for the ones in the range. When the F5 code disappears that user interface board is defective. If the reading is below four or above twelve volts DC replace the mother board. If the F5 code does not disappear recheck the harness and replace the user interface boards one at a time.

**F6 code:**

Indicates a communication failure between the mother board and the electronic oven control. This failure could be caused by a defective wire harness between the EOC and mother board, a faulty mother board, or faulty EOC.

Test the wire harness from the EOC to the mother board with an ohm meter. If the harness checks good replace the mother board. If the fault code is still present then replace the EOC

**F7 code:**

Indicates a failed potentiometer, a user interface board or the harness between the mother board and the user interface boards. To determine which has failed, check the resistance of the potentiometers. The resistance between the two outside pins should be within 10% of the potentiometer value (black 10,000 Ohms, gray 20,000 Ohms). From the center pin to an outside pin the resistance should vary between 500 and 9500 Ohms on the black and 1000 and 19,000 Ohms on the gray, as the shaft is turned.

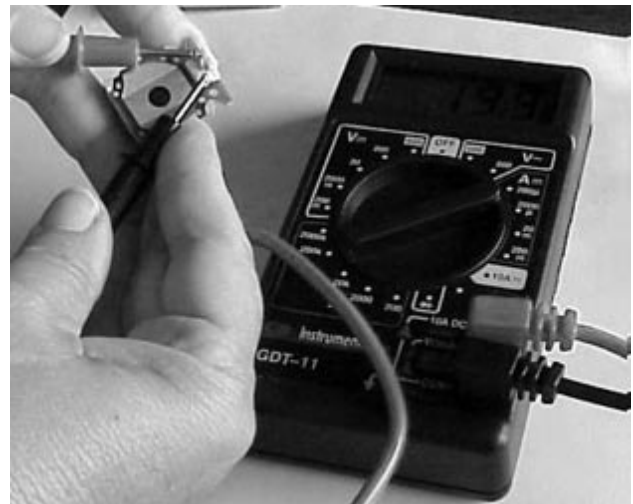

**Potentiometer test**

**NOTE:** When testing from an outside pin to the center pin the potentiometer must be turned on.

If the potentiometers test good, remove and Ohm out the harness. If the harness checks good, reinstall the harness and replace one of the user interface boards with a new or known good board. Turn one of the top elements on. If the element operates normal, replace the user interface board. If the F7 reappears, turn the top element off, reinstall the board that was replaced and replace the other user interface board. Turn one of the top elements on. If the element operates normal replace that user interface board. If the F7 still appears, recheck the harness.

**Blank display:**

If the display remains blank when an element is turned on, listen to see if you hear a beep when the element is turned on. If the range beeps, one of the user interface



boards or the harness between the mother board and the user interface boards is defective. Remove and Ohm out the harness. If the harness checks good, reinstall the harness and replace one of the user interface board with a new or known good board. Turn one of the top elements on. If the element operates normal replace that user interface board. If the display remain blank, turn the top element off, reinstall the board that was replaced and relpace the other user interface board. Turn one of the top elements on. If the element operates normal, replace that user interface board. If the display remains blank, recheck the harness between the mother board and the user interface boards. If you do not hear the beep, replace the mother board.

### Element not heating:

If an element or portion of an element does not heat but the display shows the correct indication, either the mother board, the element, or the element wiring is defective.

To determine which is defective:

1. Turn all surface element switches **off**.
2. Check the wiring diagram on the range to see which terminal on the mother board is wired to that element or portion of that element.
3. With a voltmeter measure the voltage drop between that terminal and neutral on the mother board. If the meter reads line to neutral voltage (120 VAC) the mother board is defective. If the meter reads zero the element or wiring to the element is defective.
4. Turn the switch to high, raise the cooktop, and measure the voltage drop across the element. If the meter reads line to line voltage (240 VAC) the element is defective. If the meter reads zero the wiring is bad.

### Warm and serve zone:

The warm and serve zone circuit on smooth top ranges uses a line to neutral (120 VAC) standard infinite switch, a line to neutral (120 VAC) element with a built-in limiter to protect the glass, and an indicator light.

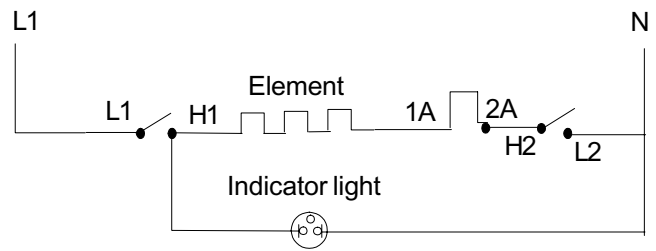
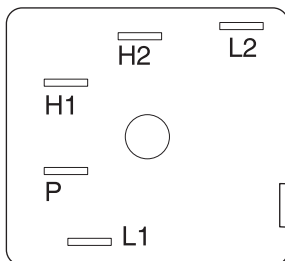

### Troubleshooting:

There are four ways a warming zone system with a standard 120 VAC infinite switch can fail:

1. The element does not heat.
2. The switch does not cycle the element off and on when set to a position other than high.
3. The element operates correctly, but the indicator light does not glow.
4. Indicator light glows with all the infinite switches in the off position.

**NOTE:** If the indicator light glows very dimly with the switches in the off position, this is caused by a capacitive feed over in the wiring and can be corrected by connecting a 100,000 Ohm 1/4 watt resistor in parallel with the light.

### Element does not heat:

Checking the system with a Voltmeter, if the element does not heat up:

1. Remove the back panel of the backguard to expose the switch terminals.
2. With a Voltmeter set for AC on a scale higher than 120 Volts measure the voltage drop between terminals L1 and L2. If the meter reads zero the wiring between the main terminal block of the range and the switch is open. If the meter reads line to neutral voltage (around 120 VAC) go to step 3.
3. With the switch turned on to the high position measure the voltage drop between terminals H1 and H2. If the meter reads zero the switch is defective. If the meter reads line to neutral voltage the switch is good. Go to step 4.
4. Raise the top and locate the two terminals on the element with the wires from H1 and H2. Measure the voltage drop between the two terminals. If the meter reads zero the wires between the switch and the element are open. If the meter reads line to neutral (120 VAC) the element is defective.



**Element does not cycle:**

If the element does not cycle when the switch is set in a position other than high the switch is defective.

**Indicator light does not glow:**

If indicator light does not glow when the switch is turned on, remove the back panel of the backguard, turn the switch on, and measure the voltage drop between terminals H1 and neutral. If the meter reads zero the switch is defective. If the meter reads line to neutral voltage (around 120 VAC) the light or the wiring to the light is defective.

**Indicator light glows full brilliance with the warm and serve switch turned off:**

If indicator light glows full brilliance with the warm and serve switch off, the switch is defective.

## SECTION C - ELECTRONIC OVEN CONTROL SYSTEMS

This section covers five electronic oven control systems.

1. ES 100
2. ES 200
3. ES 300
4. ES 400
5. ES 450

### The ES 100 Electronic Oven Control System:

The ES 100 electronic oven control system is used to control ovens on non self-cleaning model ranges.

#### How to program the ES 100:

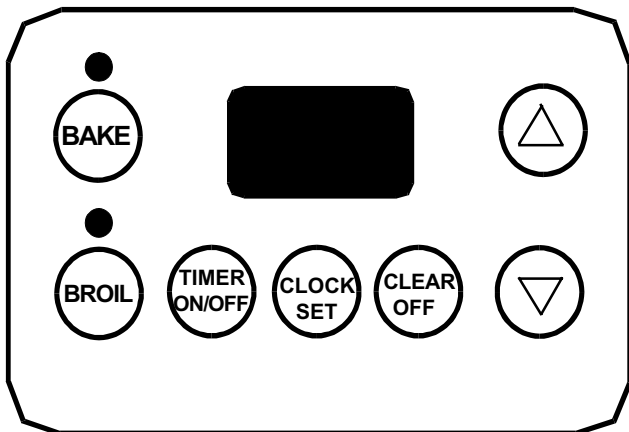

#### To set the clock:

When the range is first plugged in, or when the power supply to the range has been interrupted, the display will flash "12:00".

1. Press **Clock Set**.
2. Within 5 seconds, press and hold the **Up Arrow** or **Down Arrow** until the correct time of day appears in the display.

#### To set the minute timer:

1. Press **Timer ON/OFF**.
2. Press the **Up Arrow** to increase the time in one minute increments. Press and hold the **Up Arrow** to increase the time in 10 minute increments. The

timer can be set for any amount of time from 1 minute to 11 hours and 59 minutes. (Note: If you press the **Down Arrow** first, the timer will advance to 11 hours and 59 minutes.)

3. The display shows the timer count down in minutes until one minute remains. Then the display will count down in seconds.
4. When the set time has run out, the timer will sound a 3 second beep. 0:00 will appear in the display until **Timer ON/OFF** is pressed.

**NOTE:** While the minute timer is counting down, the ":" will flash. The minute timer does not start or stop cooking. It serves as an extra timer in the kitchen that will beep when the set time has run out. The minute timer can be used alone or during any of the other oven functions. When the minute timer is in use with any other function, the minute timer will be shown in the display. To view other functions, press the pad for that function.

#### To change the minute timer while it is in use:

While the timer is active and shows in the display, press and hold the **Up Arrow** or **Down Arrow** to increase or decrease the time.

#### To cancel the minute timer before the set time has run out:

Press **Timer ON/OFF**.

#### To set or change the temperature for baking:

The oven can be programmed to bake at any temperature from 170°F to 500°F.

#### To set the controls for baking:

1. Press **Bake**. "— — —°" appears in the display.
2. Within 5 seconds, press the **Up Arrow** or **Down Arrow**. The display will show "350°F." By pressing and holding the **Up Arrow** or **Down Arrow**, the temperature can then be adjusted in small 5°F increments.
3. When the **Up Arrow** or **Down Arrow** is released, the oven will begin heating to the selected temperature. When the displayed temperature reaches the desired baking temperature, the control will beep 3 times.
4. To cancel the baking function, press **Clear Off**.

#### To change the oven temperature after baking has started:

1. Press **Bake** and make sure the bake temperature is displayed.
2. Press the **Up Arrow** or **Down Arrow** to increase or decrease the set temperature.

**To broil:**

1. Arrange oven rack while oven is still cool. Position the rack as suggested in the chart below.

Rack Position From Top	Food
1	Rare steaks
2	Fish, medium steaks, hamburgers and chops
3	Well-done foods such as chicken and lobster

2. Press **Broil**.
3. Press and hold the **Up Arrow** or **Down Arrow** until the desired broil setting level appears in the display. Press the **Up Arrow** for **HI** broil or the **Down Arrow** for **LO** broil. Most foods can be broiled at the **HI** broil setting. Select the **LO** broil setting to avoid excess browning or drying of foods that should be broiled to the well-done stage.
4. Place the insert on the broiler pan, then place the food on the insert. **DO NOT** use the broiler pan without the insert or cover the insert with aluminum foil. The exposed grease could ignite.
5. Place the pan on the oven rack. **Open the oven door to the broil stop position when broiling.**
6. Broil on one side until food is browned; turn and cook on the second side. **Note:** Always pull the rack out to the stop position before turning or removing food.
7. When broiling is finished, press **Clear Off**.

**CAUTION: SHOULD AN OVEN FIRE OCCUR, CLOSE THE OVEN DOOR AND TURN OFF THE OVEN. IF THE FIRE CONTINUES, USE A FIRE EXTINGUISHER. DO NOT PUT WATER OR FLOUR ON THE FIRE. FLOUR MAY BE EXPLOSIVE.**

**How the ES 100 operates:**

**CAUTION: NEVER ATTEMPT TO REMOVE EITHER**

**THE BAKE OR BROIL ELEMENT WITHOUT DISCONNECTING ELECTRICAL POWER FROM THE RANGE. ELECTRICAL POWER IS CONNECTED TO THE ELEMENTS WHENEVER ELECTRICAL POWER IS CONNECTED TO THE RANGE.**

The ES 100 electronic oven control system is made up of two parts that control the bake and broil elements.

1. Electronic oven control.
2. Oven temperature sensor.

**Bake:**

When the bake pad is touched, and a temperature is set with the up or down arrows, the bake relay on the board closes. This connects one side of the line to the bake element. In the tip of the oven sensor is a positive thermistor that increases in resistance as the oven temperature increases. The microprocessor reads the resistance of the oven sensor, and compares it with programmed temperature set into the control. When the resistance of the oven sensor indicates temperature in the oven is about 10 degrees above the programmed temperature, the microprocessor opens the relay, which removes power from one side of the element. When power is removed from the element the oven temperature begins to lower. As the oven temperature lowers the resistance of the oven sensor decreases. When the oven drops to about 10 degrees below the programmed temperature, the resistance of the sensor tells the microprocessor to close the bake relay contacts, and provide power to the bake element once again.

**NOTE: Oven controls may have a temperature swing of more or less than 20 degrees. The important thing is the average temperature in the oven. The average temperature in the center of the oven should be within 10 degrees of the programmed temperature.**

**Broil:**

When the broil pad is touched, and High or Low is set with the up or down arrows, the broil relay on the board closes. This connects one side of the line to the broil element. In the tip of the oven sensor is a positive thermistor that increases in resistance as the oven temperature increases. The microprocessor reads the resistance of the oven sensor, and compares it with a programmed temperature set into the control. Usually you do not want the broil element to cycle so the oven door is opened to the broil stop position. If the door is not opened the broil element will cycle when the set temperature is reached.

**Calibration:**

**To check oven calibration:**

1. Place a thermometer or thermocouple in the center of the oven.
2. Program the oven for bake and the temperature to 350° F. Allow the oven to cycle three times.
3. Average the highest and lowest readings. The average should be within 10° of 350° F.

**The calibration of the ES100 system cannot be adjusted:**

1. If the oven temperature test off. Check the resistance of the oven sensor circuit against the chart below. If the sensor circuit check good replace the control.

RTD SCALE	
Temperature (°F)	Resistance (ohms)
32 ± 1.9	1000 ± 4.0
75 ± 2.5	1091 ± 5.3
250 ± 4.4	1453 ± 8.9
350 ± 5.4	1654 ± 10.8
450 ± 6.9	1852 ± 13.5
550 ± 8.2	2047 ± 15.8
650 ± 9.6	2237 ± 18.5
900 ± 13.6	2697 ± 24.4

**Troubleshooting:**

The ES 100 has some self diagnostics built into the microprocessor to help in troubleshooting the system. When a failure occurs one of two codes will appear in all of the display windows; F1 or F3.

**F1 code:**

An F1 indicates a malfunction in the EOC itself, and the control should be replaced.

**F3 code:**

An F3 indicates a defective sensor, electronic oven control or the wiring in between. To determine which part is defective:

1. Disconnect the 6 pin plug from the back of the oven control that connects the sensor to the oven control.
2. With an Ohmmeter measure the resistance between pins 1 and 2 in the plug (not on the control board). If the meter reads around the value of the oven temperature sensor shown in the below resistance

chart, the oven control is defective. If the meter reads less than 800 Ohms or more than 3000 Ohms, go to step 3.

RTD SCALE	
Temperature (°F)	Resistance (ohms)
32 ± 1.9	1000 ± 4.0
75 ± 2.5	1091 ± 5.3
250 ± 4.4	1453 ± 8.9
350 ± 5.4	1654 ± 10.8
450 ± 6.9	1852 ± 13.5
550 ± 8.2	2047 ± 15.8
650 ± 9.6	2237 ± 18.5
900 ± 13.6	2697 ± 24.4

3. Disconnect the harness from the oven sensor and measure the resistance of the oven sensor. If the reading is less than 800 Ohms or more than 3000 Ohms, the oven sensor is defective. If the reading is correct with the chart, the harness is defective.

**Control will not program:**

If the control will not program check for an open sensor circuit. If the sensor circuit is good replace the control.

**Blank Display:**

If the display on the oven control is blank and the range is connected to electrical power:

1. Go to the back of the control and measure the voltage drop between terminals L1 and 4 of the 6 pin plug (neutral). If the meter reads line to neutral voltage (120 VAC) the control is defective. If the meter reads zero, the wiring in the range is defective.

**No heat:**

If the control appears to be operating normally but the bake element does not heat:

1. Go to the back of the oven control and measure the voltage drop between terminals BA and pin 4 of the 6 pin plug (neutral) with the control not programmed (clock operating only). If the meter reads line to neutral (120 VAC) the control is defective. If the meter reads zero the bake element or the wiring to the bake element is defective. Go to step 2.
2. Remove the back from the range to gain access to the terminals of the bake element. Program the oven control for bake and measure the voltage drop across the terminals of the bake element. If the meter reads line to line voltage (240 VAC) the

element is defective. If the meter reads zero the wiring to the element is open.

If the control appears to be operating normally but the broil element does not heat:

1. Go to the back of the oven control and measure the voltage drop between terminals BR and pin 4 of the 6 pin plug (neutral) with the control not programmed (clock operating only). If the meter reads line to neutral (120 VAC) the control is defective. If the meter reads zero the broil element or the wiring to the broil element is defective. Go to step 2.
2. Remove the back from the range to gain access to the terminals of the broil element. Program the oven control for broil and measure the voltage drop across the terminals of the broil element. If the meter reads line to line voltage (240 VAC) the element is defective. If the meter reads zero the wiring to the element is open.

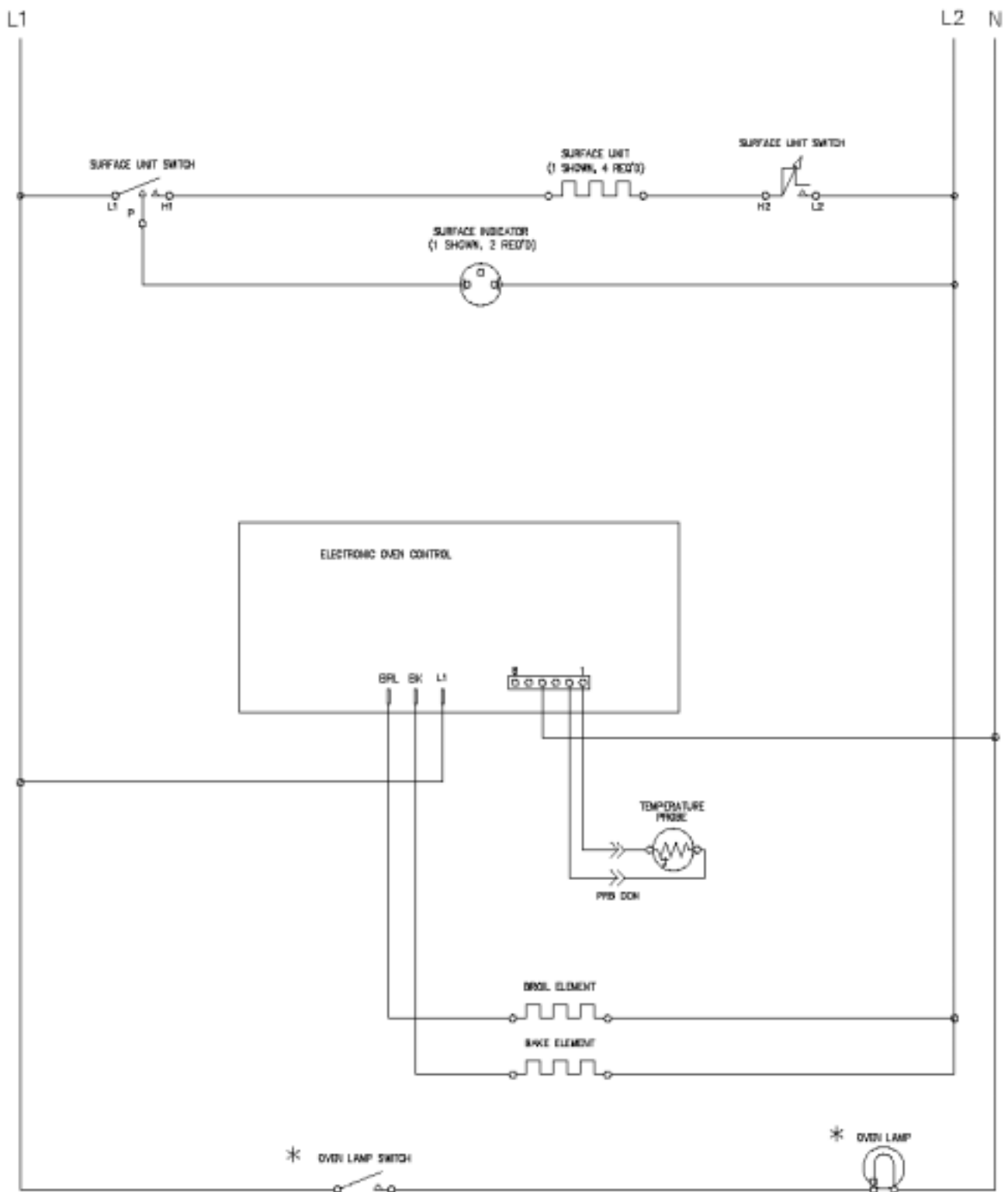

SAMPLE SCHEMATIC FOR ES100 CONTROL SYSTEM

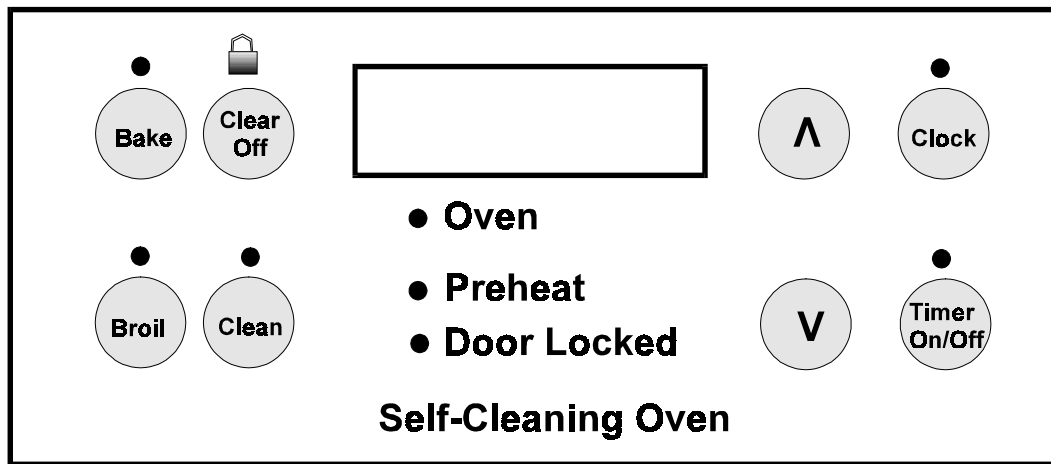

### The ES 200 Electronic Oven Control System:

The ES 200 electronic oven control system is used to control the oven on self-cleaning model ranges that do not have the timed bake, speed bake or the convection features.

### How to program the ES 200:

The oven can be programmed to: Bake, Broil, Self-Clean, Continuous Bake, and set for Oven Lockout.

### Temperature conversion:

The electronic oven control is set to operate in °F (Fahrenheit) when shipped from the factory. The oven can be programmed for any temperature from 170° F to 550° F (65° C to 287° C Celsius).

### To change the temperature from °F to °C or from °C to °F:

**NOTE: Control should not be in a Bake or Clean mode.**

1. Press **Broil**. "— —" appears in the display.
2. Press and hold the **Up Arrow** until "HI" appears in the display.
3. Press and hold **Broil** until °F or °C appears in the display.
4. Press the **Up Arrow** or **Down Arrow** to change °F to °C or °C to °F.
5. Press any control pad to return to normal operating mode.

**NOTE: The time of day must first be set in order to operate the oven.**

### To set the clock:

When the range is first plugged in, or when the power supply to the range has been interrupted, the display will flash "12:00".

1. Press **Clock**.
2. Within 5 seconds, press and hold the **Up Arrow** or **Down Arrow** until the correct time of day appears in the display.

**NOTE: The clock cannot be changed during the self-clean cycle.**

### To set the minute timer:

1. Press **Timer ON/OFF**.
2. Press the **Up Arrow** to increase the time in one minute increments. Press and hold the **Up Arrow** to increase the time in 10 minute increments. The timer can be set for any amount of time from 1 minute to 11 hours and 59 minutes.  
**NOTE: If you press the Down Arrow first, the timer will advance to 11 hours and 59 minutes.**
3. The display shows the timer count down in minutes until one minute remains. Then the display will count down in seconds.
4. When the set time has run out, the timer will beep 3 times. It will then continue to beep 3 times every 60 seconds until **Timer ON/OFF** is pressed.

**NOTE: The minute timer does not start or stop cooking. It serves as an extra timer in the kitchen that will beep when the set time has run out. The minute timer can be used alone or during any of the other oven functions. When the minute timer is in use with any other function, the minute timer will be shown in the display. To view other functions, press the pad for that function.**

**To change the minute timer while it is in use:**

While the timer is active and shows in the display, press and hold the **Up Arrow** or **Down Arrow** to increase or decrease the time.

**To cancel the minute timer before the set time has run out:**

Press **Timer ON/OFF** .

**To set or change the temperature for baking:**

The oven can be programmed to bake at any temperature from 170° F to 550° F (65° C to 287° C).

**To set the controls for baking:**

1. Press **Bake**. "— — —" appears in the display.
2. Within 5 seconds, press the **Up Arrow** or **Down Arrow**. The display will show "350° F (177° C)." By pressing and holding the **Up Arrow** or **Down Arrow**, the temperature can then be adjusted in 5° F (1° C) increments.
3. As soon as the **Up Arrow** or **Down Arrow** is released, the oven will begin heating to the selected temperature. When the displayed temperature reaches the desired baking temperature, the control will beep 3 times.
4. To cancel the baking function, press **Clear/Off**.

**To change the oven temperature after baking has started:**

1. Press **Bake** and make sure the bake temperature is displayed.
2. Press the **Up Arrow** or **Down Arrow** to increase or decrease the set temperature.

**To set control for continuous bake or 12 hour energy saving:**

The oven control has a built-in 12 hour energy saving feature that will shut off the oven if the control is left on for more than 11 hours and 59 minutes. The oven can be programmed to override this feature for continuous baking.

**To set control for continuous baking:**

1. Press **Timer ON/OFF** , "0:00" will appear in the display.
2. Press and hold **Timer ON/OFF** down for 5 seconds

until tone is heard, " — — hr" will appear in display for continuous cooking. The current time of day will return to the display.

3. To cancel the Continuous Bake function, press **Timer ON/OFF** and hold for 5 seconds until tone is heard. "12hr" will appear in display indicating that the control has returned to the 12 hour energy saving feature.

**To set control for oven lockout feature:**

1. Press **Clear/Off** and hold for 3 seconds. "Loc" will appear in display, the "Door Locked" indicator light will flash and the motor driven door lock will begin to close automatically. **DO NOT open oven door** while the indicator light is flashing. Allow about 15 seconds for the oven door to lock. Once the oven door is locked, the current time of day will appear in the display.
2. To cancel the lockout feature, press **Clear/Off** and hold for 3 seconds. The control will unlock the oven door and resume normal operation.

**To broil:**

1. Arrange oven rack while oven is still cool. Position the rack as suggested in the chart below.

Rack Position From Top	Food
1	Rare steaks
2	Fish, medium steaks, hamburgers and chops
3	Well-done foods such as chicken and lobster

2. Press **Broil**.
3. Press and hold the **Up Arrow** or **Down Arrow** until the desired broil setting level appears in the display. Press the **Up Arrow** for **HI** broil or the **Down Arrow** for **LO** broil. Most foods can be broiled at the **HI** broil setting. Select the **LO** broil setting to avoid excess browning or drying of foods that should be broiled to the well-done stage.
4. Place the insert on the broiler pan, then place the food on the insert. **DO NOT** use the broiler pan without the insert or cover the insert with aluminum foil. The exposed grease could ignite.



- Place the pan on the oven rack. **Open the oven door to the broil stop position when broiling.**
- Broil on one side until food is browned; turn and cook on the second side. **NOTE:** Always pull the rack out to the stop position before turning or removing food.
- When broiling is finished, press **Clear/Off**.

**CAUTION: SHOULD AN OVEN FIRE OCCUR, CLOSE THE OVEN DOOR AND TURN OFF THE OVEN. IF THE FIRE CONTINUES, USE A FIRE EXTINGUISHER. DO NOT PUT WATER OR FLOUR ON THE FIRE. FLOUR MAY BE EXPLOSIVE.**

#### To set the controls for a self-clean cycle:

For satisfactory results use a 2 hour self-clean cycle for **light soils** and a 3 hour cycle for **average to heavy soils**.

- Be sure the clock shows the correct time of day.
- Press **Clean**. "— — —" appears in the display.
- Press the **Up Arrow** until "3:00" appears in the display for a 3 hour cycle, or press the **Down Arrow** until "2:00" appears in the display for a 2 hour cycle.
- As soon as the **Up Arrow** or **Down Arrow** is released, "CLN" appears in the display.
- As soon as the controls are set, the motor driven lock will begin to close automatically and the "LOCK" indicator light will flash. **DO NOT** open the door while the light is flashing (it takes about 15 seconds for the oven door to lock).
- The "LOCK" light will glow until the cleaning cycle is completed or cancelled, and the oven temperature has cooled.

#### When the self-clean cycle is completed:

- The time of day or "END" will appear in the display window and the "Clean" and "LOCK" light will continue to glow.
- Once the oven has cooled down for about 1 HOUR and the "LOCK" light has gone out, the oven door can be opened.
- If "END" is in the display and the "Clean" indicator remains on, press **Clear/Off**. The time of day will appear in the display.

**NOTE:** When the oven is cool, wipe away any residue or powdered ash with a damp cloth or paper towel.

#### Stopping or interrupting a self-cleaning cycle:

If it becomes necessary to stop or interrupt a self-cleaning cycle.

- Press **Clear/Off**.
- Once the oven has cooled down for about 1 HOUR and the "LOCK" light has gone out, the oven door can be opened.
- Restart the self-clean cycle once all conditions have been corrected.

#### How the ES 200 operates:

**CAUTION: NEVER ATTEMPT TO REMOVE EITHER THE BAKE OR BROIL ELEMENT WITHOUT DISCONNECTING ELECTRICAL POWER FROM THE RANGE. ELECTRICAL POWER IS CONNECTED TO THE ELEMENTS WHENEVER ELECTRICAL POWER IS CONNECTED TO THE RANGE.**

The ES 200 electronic oven control system is made up of three parts that control the bake and broil elements, and the locking of the door in the self-clean cycle.

- Electronic oven control.
- Oven temperature sensor.
- Oven door lock mechanism.

#### Bake:

When the bake pad is touched, and a temperature is set with the up or down arrows, the bake relay on the board closes. This connects one side of the line to the bake element. In the tip of the oven sensor is a positive thermistor that increases in resistance as the oven temperature increases. The microprocessor reads the resistance of the oven sensor, and compares it with programmed temperature set into the control. When the resistance of the oven sensor indicates temperature in the oven is about 10 degrees above the programmed temperature, the microprocessor opens the relay, which removes power from one side of the element. When power is removed from the element the oven temperature begins to lower. As the oven temperature lowers the resistance of the oven sensor decreases. When the oven drops to about 10 degrees below the programmed temperature, the resistance of the sensor tells the microprocessor to close the bake relay contacts, and

provide power to the bake element once again. After the first cycle the preheat light is turned off and whenever the oven calls for heat, the EOC cycles the broil element on for seven seconds and then the bake element on for fifty three seconds out of every minute. This provides top heat during the bake cycle. The two elements will never be on at the same time.

**NOTE: Oven controls may have a temperature swing of more or less than 20 degrees. The important thing is the average temperature in the oven. The average temperature in the center of the oven should be within 10 degrees of the programmed temperature.**

#### **Broil:**

When the broil pad is touched, and High or Low is set with the up or down arrows, the broil relay on the board closes. This connects one side of the line to the broil element. In the tip of the oven sensor is a positive thermistor that increases in resistance as the oven temperature increases. The microprocessor reads the resistance of the oven sensor, and compares it with a programmed temperature set into the control. Usually you do not want the broil element to cycle so the oven door is opened to the broil stop position. If the door is not opened the broil element will cycle when the set temperature is reached.

#### **Clean:**

With the oven door closed, contacts COM to NO of the oven door switch close. Then when the clean pad is touched and a clean time is set the door lock relay on the electronic oven control closes providing line to neutral voltage (120 VAC) to the lock motor. "CLN" appears in the display and the lock indicator light blinks. The lock motor starts to rotate, closing the contacts of the door lock switch. When the motor rotates one half turn the contacts of the door lock switch reopen sending a signal to the EOC that the door is locked, and to open the contacts of the lock relay. The lock indicator light then glows steady and the EOC closes the bake relay providing power to the bake element. The clean temperature is preset into the EOC at around 860° F. It takes about 45 minutes for the oven to reach 860° F. When the temperature is reached the control cycles the bake element off and on to maintain the temperature until the clean time is completed. When the clean time is completed the EOC removes power from the bake element and the oven cools down. When the temperature in the oven goes below 500° F the control closes the contacts of the lock relay. The lock motor then turns 180 degrees closing and reopening the contacts of the lock switch and unlocking the door. The open contacts of the

lock switch tells the control that the door is unlocked and to open the contacts of the lock relay and turn the lock indicator light off.

#### **Calibration:**

##### **To check oven calibration:**

1. Place a thermometer or thermocouple in the center of the oven.
2. Program the oven for bake and the temperature to 350° F. Allow the oven to cycle three times.
3. Average the highest and lowest readings. The average should be within 10° of 350° F.

##### **To change the calibration:**

1. Touch the bake pad on the control, and using the up arrow set the oven temperature to maximum (550° F).
2. Within 3 seconds touch and hold the bake pad (about 5 seconds) until "00" appear in the display.

**NOTE: If any numbers other than "00" appear in the display, the control has been previously calibrated in the field.**

3. By using the up or down arrows the calibration temperature can be changed + or - 35° F.
4. When the desired calibration is reached, touch the cancel pad to return the control to normal operation.

#### **Troubleshooting:**

The ES 200 has some self diagnostics built into the microprocessor to help in troubleshooting the system. When a failure occurs one of three codes will appear in all the display windows; F1, F3 and F9.

##### **F1 code:**

An F1 indicates a malfunction in the control itself, and the control should be replaced.

##### **F3 code:**

An F3 indicates a defective sensor, electronic oven control or the wiring in between. To determine which part is defective:

1. Disconnect the 15 pin plug from the back of the oven control that connects the sensor to the oven control.

2. With an Ohmmeter measure the resistance between pins 12 and 13 in the plug (not on the control board). If the meter reads around the value of the oven temperature sensor shown in the below resistance chart, the oven control is defective. If the meter reads less than 800 Ohms or more than 3000 Ohms, go to step 3.

RTD SCALE	
Temperature (°F)	Resistance (ohms)
32 ± 1.9	1000 ± 4.0
75 ± 2.5	1091 ± 5.3
250 ± 4.4	1453 ± 8.9
350 ± 5.4	1654 ± 10.8
450 ± 6.9	1852 ± 13.5
550 ± 8.2	2047 ± 15.8
650 ± 9.6	2237 ± 18.5
900 ± 13.6	2697 ± 24.4

3. Disconnect the harness from the oven sensor and measure the resistance of the oven sensor. If the reading is less than 800 Ohms or more than 3000 Ohms, the oven sensor is defective. If the reading is correct with the chart, the harness is defective.

#### **F9 code:**

An F9 code indicates the control has detected a problem with the motor door latch assembly. Check the contacts of the lock switch, wiring to the lock motor assembly, and the lock motor.

#### **Control will not program:**

If the control will not program check for an open sensor circuit. If the sensor circuit is good replace the control.

#### **Blank display:**

If the display on the oven control is blank and the range connected to electrical power:

1. Go to the back of the control and measure the voltage drop between terminal L1 and neutral. If the meter reads line to neutral voltage (120VAC) the control is defective. If the meter reads zero the wiring in the range is defective.

#### **No heat:**

If the control appears to be operating normally, but the bake element does not heat:

1. Go to the back of the oven control and measure the voltage drop between terminals BA and neutral with the control not programmed (clock operating only).

If the meter reads line to neutral (120VAC) the control is defective. If the meter reads zero the bake element or the wiring to the bake element is defective. Go to step 2.

2. Remove the back from the range to gain access to the terminals of the bake element. Program the oven control for bake and measure the voltage drop across the terminals of the bake element. If the meter reads line to line voltage (240VAC) the element is defective. If the meter reads zero the wiring to the element is open.

If the control appears to be operating normally, but the broil element does not heat:

1. Go to the back of the oven control and measure the voltage drop between terminals BR and neutral with the control not programmed (clock operating only). If the meter reads line to neutral (120VAC) the control is defective. If the meter reads zero the broil element or the wiring to the broil element is defective. Go to step 2.
2. Remove the back from the range to gain access to the terminals of the broil element. Program the oven control for broil and measure the voltage drop across the terminals of the broil element. If the meter reads line to line voltage (240VAC) the element is defective. If the meter reads zero the wiring to the element is open.

#### **Oven door does not lock when the oven is programmed for clean:**

1. Remove power from the range, go to the back of the control and disconnect the 15 pin plug. Measure the resistance between pins 5 and 6 of the 15 pin plug (not on the EOC). If the meter reads infinity the lock motor or the wiring to the lock motor is defective. If the meter reads around 1500 ohms go to step 2.
2. Measure the resistance between pins 9 and 11 of the 15 pin plug with the oven door closed. If the meter reads infinity the door switch or the wiring to the door light switch is defective. If the meter reads zero go to step 3.
3. Measure the resistance between pins 9 and 10 of the 15 pin plug. If the meter reads infinity the lock switch or the wiring to the lock switch is defective. If the meter reads zero the control is defective.

**Oven door locks when the oven is programmed for clean but the oven does not heat:**

1. If the oven operates normally in bake, replace the control.

**Lock motor runs continuously:**

1. With the door in the unlock position, remove power from the range. Go to the back of the control and disconnect the 15 pin plug from the control. With an Ohmmeter measure the resistance between pins 9 and 10 of the 15 pin plug (not on the EOC). If the meter reads zero the lock switch or the wiring to the lock switch is defective. If the meter reads infinity go to step 2.
2. Depress the arm of the lock switch, and measure the resistance between pins 9 and 10 of the 15 pin plug. If the meter reads infinity the lock switch or the wiring to the lock switch is defective. If the meter reads zero the control is defective.

**Door latch is partly closed with door open, cannot close door:**

1. Program the oven for self-clean, and hold in on the door switch for 30 seconds. Touch cancel and hold door switch in for 30 seconds. The lock motor should lock and unlock the door.

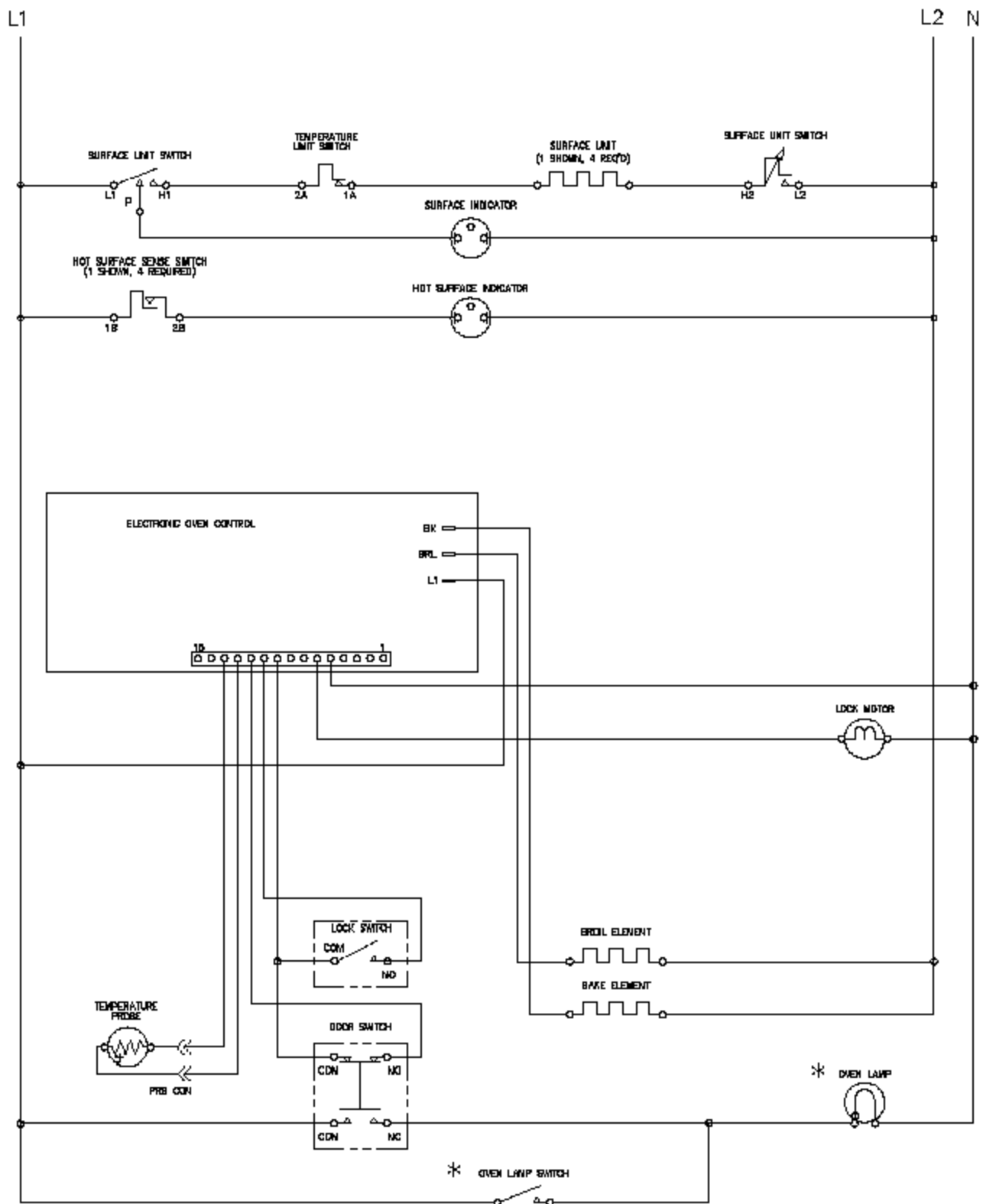

NOTES:

1. CIRCUIT SHOWN WITH ALL CONTROLS SET TO OFF.  
OVEN DOOR CLOSED AND UNLOCKED.
2. COMPONENTS WITH \* DO NOT APPEAR ON ALL MODELS.

SAMPLE SCHEMATIC FOR THE ES 200 CONTROL SYSTEM

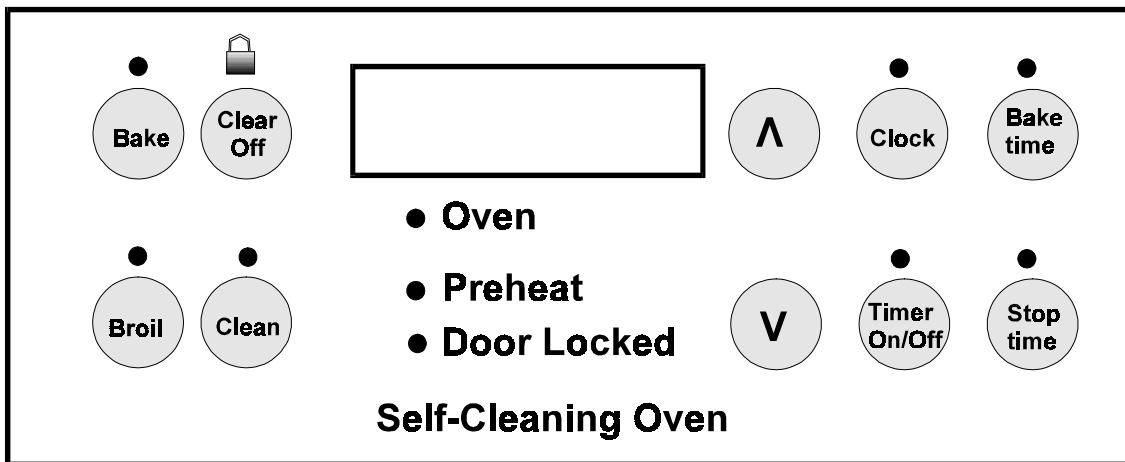

**The ES 300 Electronic Oven Control System:**

The ES 300 electronic oven control system is used to control the oven on self-cleaning model ranges that do not have the convection feature.

**How to program the ES 300:**

The oven can be programmed to: Bake, Timed Bake, Speed Bake, Broil, Self-Clean, Continuous Bake, and set for Oven Lockout.

**For a silent control panel:**

When choosing a function, a beep will be heard each time a pad is pressed. If desired, the controls can be programmed for silent operation. Press and hold **Stop time**. After 7 seconds, the control will beep once. This will block the controls from sounding when a pad is pressed. To return the sound, press and hold **Stop time** again for 7 seconds until the control beeps once.

**NOTE:** The control will return to the audible mode after a power outage.

**Temperature conversion:**

The electronic oven control is set to operate in °F (Fahrenheit) when shipped from the factory. The oven can be programmed for any temperature from 170° F to 550° F (65° C to 287° C).

**To change the temperature from °F to °C or from °C to °F (control should not be in a bake or clean mode):**

1. Press **Broil**. "— —" appears in the display.
2. Press and hold the **Up Arrow** until "HI" appears in the display.
3. Press and hold **Broil** until °F or °C appears in the display.

4. Press the **Up Arrow** or **Down Arrow** to change °F to °C or °C to °F.
5. Press any control pad to return to normal operating mode.

**To set the clock:**

When the range is first plugged in, or when the power supply to the range has been interrupted, the display will flash "12:00".

1. Press **Clock**.
2. Within 5 seconds, press and hold the **Up Arrow** or **Down Arrow** until the correct time of day appears in the display.

**NOTE: The clock cannot be changed during any timed bake or self-clean cycle.**

**To set the minute timer:**

1. Press **Timer On/Off**.
2. Press the **Up Arrow** to increase the time in one minute increments. Press and hold the **Up Arrow** to increase the time in 10 minute increments. The timer can be set for any amount of time from 1 minute to 11 hours and 59 minutes.  
**NOTE:** If you press the **Down Arrow** first, the timer will advance to 11 hours and 59 minutes.
3. The display shows the timer count down in minutes until one minute remains. Then the display will count down in seconds.
4. When the set time has run out, the timer will beep 3 times. It will then continue to beep 3 times every 60 seconds until **Timer On/Off** is pressed.

**NOTE:** The minute timer does not start or stop cooking. It serves as an extra timer in the kitchen that will beep

when the set time has run out. The minute timer can be used alone or during any of the other oven functions. When the minute timer is in use with any other function, the minute timer will be shown in the display. To view other functions, press the pad for that function.

#### To change the minute timer while it is in use:

While the timer is active and shows in the display, press and hold the **Up Arrow** or **Down Arrow** to increase or decrease the time.

#### To cancel the minute timer before the set time has run out:

Press **Timer On/Off**.

#### To set or change the temperature for baking:

The oven can be programmed to bake at any temperature from 170° F to 550° F (65° C to 287° C).

#### To set the controls for baking:

1. Press **Bake**. "— — —" appears in the display.
2. Within 5 seconds, press the **Up Arrow** or **Down Arrow**. The display will show "350° F (177° C)." By pressing and holding the **Up Arrow** or **Down Arrow**, the temperature can then be adjusted in 5° F (1° C) increments.
3. As soon as the **Up Arrow** or **Down Arrow** is released, the oven will begin heating to the selected temperature. When the displayed temperature reaches the desired baking temperature, the control will beep 3 times.
4. To cancel the baking function, press **Clear Off**.

#### To change the oven temperature after baking has started:

1. Press **Bake** and make sure the bake temperature is displayed.
2. Press the **Up Arrow** or **Down Arrow** to increase or decrease the set temperature.

#### To set control for continuous bake or 12 hour energy saving:

The oven control has a built-in 12 hour energy saving feature that will shut off the oven if the control is left on for more than 11 hours and 59 minutes. The oven can be programmed to override this feature for continuous baking.

#### To set control for continuous baking:

1. Press **Timer On/Off**, "0:00" will appear in the display.
2. Press and hold **Timer On/Off** down for 5 seconds until tone is heard, "— — hr" will appear in display for continuous cooking. The current time of day will return to the display.
3. To cancel the Continuous Bake function, press **Timer On/Off** and hold for 5 seconds until tone is heard. "12hr" will appear in display indicating that the control has returned to the 12 hour energy saving feature.

#### To set control for oven lockout feature:

1. Press **Clear Off** and hold for 3 seconds. "Loc" will appear in display, the "Door Locked" indicator light will flash and the motor driven door lock will begin to close automatically. **DO NOT open oven door** while the indicator light is flashing. Allow about 15 seconds for the oven door to lock. Once the oven door is locked, the current time of day will appear in the display.
2. To cancel the lockout feature, press **Clear Off** and hold for 3 seconds. The control will unlock the oven door and resume normal operation.

#### To set the timed bake feature:

The **BAKE TIME** and **STOP TIME** controls operate the Timed Bake feature to turn the oven on and off at the times you select in advance. The oven can be programmed to start immediately and shut off automatically or to begin baking at a later time with an automatic shutoff.

#### To program the oven to begin baking immediately and to shut off automatically:

1. Be sure that the clock shows the correct time of day.
2. Place the food in the oven.
3. Press **Bake**.
4. Within 5 seconds, press the **Up Arrow** or **Down Arrow**. The display will show "350° F (177° C)." By holding the **Up Arrow** or **Down Arrow**, the temperature can then be adjusted in 5° F (1° C) increments.
5. Press **Bake Time**. "0:00" will flash in the display.
6. Press the **Up Arrow** or **Down Arrow** until the desired baking time appears in the display.

- The oven will turn on and begin heating.

**To program oven for a delayed start time and to shut-off automatically:**

- Be sure that the clock shows the correct time of day.
- Place the food in the oven.
- Press **Bake**.
- Within 5 seconds, press the **Up Arrow** or **Down Arrow**. The display will show "350° F (177° C)." By holding the **Up Arrow** or **Down Arrow**, the temperature can then be adjusted in 5° F (1° C) increments.
- Press **Bake Time**. "0:00" will flash in the display.
- Press the **Up Arrow** or **Down Arrow** until the desired baking time appears.
- Press **Stop Time**. The earliest possible stop time will flash in the display.
- Press the **Up Arrow** or **Down Arrow** until the desired stop time appears in the display.
- Once the controls are set, the control calculates the time when baking will start in order to finish at the time you have set.
- The oven will turn on at the delayed start time and begin heating.

When the set bake time runs out:

- "END" will appear in the display window and the oven will shut off automatically.
- The control will beep 3 times every 60 seconds until **Clear Off** is pressed.

**To change the oven temperature or bake time after baking has started:**

- Press the function pad you want to change.
- Press the **Up Arrow** or **Down Arrow** to adjust the setting.

**CAUTION: Use caution with the Timed Bake feature to cook cured or frozen meats and most fruits and vegetables. Foods that can easily spoil such as milk, eggs, fish, meat or poultry, should be chilled in the refrigerator first. Even when chilled, they should not stand in the oven for more than 1 hour**

**before cooking begins, and should be removed promptly when cooking is completed.**

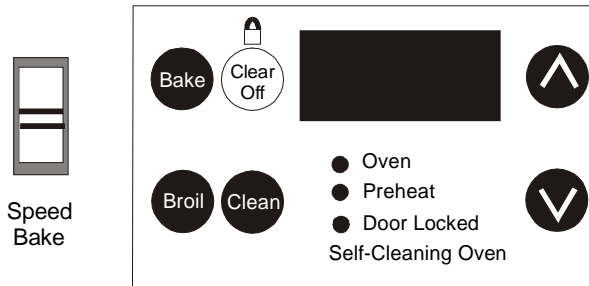

**Speed Bake™ Cooking System** (if equipped) uses a fan to circulate the oven's heat uniformly and continuously around the oven. This improved heat distribution allows for fast, even cooking and browning results. It also gives better baking results when using two racks at the same time. Heated air flows around the food from all sides, sealing in juices and flavors. Meats cooked with the **Speed Bake™ Cooking System** are juicier. Poultry is crisp on the outside while staying tender and moist on the inside. Breads and pastries brown more evenly. Most foods baked in a standard oven can be cooked faster and more evenly with the **Speed Bake™ Cooking System**.

**General cooking instructions:**

- To convert baking times for normal recipes to **Speed Bake** times, start with a 30% reduction in time and increase the time until the desired doneness is obtained. Time reductions will vary depending on the amount and type of food.
- Preheating is not necessary when cooking with **Speed Bake**, except with items such as cakes, cookies, biscuits, breads, etc.
- When using two racks at the same time, place in positions 2 and 5 for the best results.
- When baking cakes with **Speed Bake**, set temperature 25° F (13° C) degrees lower than the recommended setting for best results.

**To set Speed Bake™ Cooking System:**

- Program the oven as you normally would for baking. **Speed Bake** may be used with Bake, Time Bake and Delayed Time Bake features.
- Press and release **Speed Bake** switch. The indicator light will glow and the fan will come on. The fan stays on when the oven door is closed and shuts off while



the oven door is opened. The fan will continue to operate until baking is complete.

3. To cancel the **Speed Bake** function, press **Clear Off** on the oven control as you would to cancel any baking function.

**NOTE:** The Speed Bake feature will not work during a clean cycle.

#### To broil:

1. Arrange oven rack while oven is still cool. Position the rack as suggested in the chart below.

Rack Position From Top	Food
1	Rare steaks
2	Fish, medium steaks, hamburgers and chops
3	Well-done foods such as chicken and lobster

2. Press **Broil**.
3. Press and hold the **Up Arrow** or **Down Arrow** until the desired broil setting level appears in the display. Press the **Up Arrow** for **HI** broil or the **Down Arrow** for **LO** broil. Most foods can be broiled at the **HI** broil setting. Select the **LO** broil setting to avoid excess browning or drying of foods that should be broiled to the well-done stage.
4. Place the insert on the broiler pan, then place the food on the insert. **DO NOT** use the broiler pan without the insert or cover the insert with aluminum foil. The exposed grease could ignite.
5. Place the pan on the oven rack. **Open the oven door to the broil stop position when broiling foods.**
6. Broil on one side until food is browned; turn and cook on the second side. **NOTE:** Always pull the rack out to the stop position before turning or removing food.
7. When broiling is finished, press **Clear Off**.

**CAUTION: SHOULD AN OVEN FIRE OCCUR, CLOSE THE OVEN DOOR AND TURN OFF THE OVEN. IF THE FIRE CONTINUES, USE A FIRE EXTINGUISHER. DO NOT PUT WATER OR FLOUR**

#### ON THE FIRE. FLOUR MAY BE EXPLOSIVE.

#### Self-cleaning oven:

A self-cleaning oven cleans itself with high temperatures (well above cooking temperatures) which eliminate soil completely or reduce it to a fine powdered ash you can wipe away with a damp cloth.

#### Adhere to the following cleaning precautions:

- **DO NOT** use oven cleaners or oven protective coatings in or around any part of the self-cleaning oven.
- **DO NOT** clean the oven door gasket. The woven material of the oven door gasket is essential for a good seal. Care should be taken not to rub, damage or remove the gasket.
- **DO NOT** use any cleaning materials on the oven door gasket. Doing so could cause damage.
- **Remove the broiler pan and insert, all utensils and any aluminum foil. These items cannot withstand high cleaning temperatures.**
- Oven racks may be left in the oven or may be removed. If they go through the clean cycle their color will turn slightly blue and the finish will be dull. After the cycle is complete and the oven has cooled, rub the sides of the racks with wax paper or a cloth containing a small amount of baby oil or salad oil (this will make the racks glide easier into the rack position).
- **Remove any excess spillovers** in the oven cavity **before** starting the self-cleaning cycle. To clean, use hot, soapy water and a cloth. Large spillovers can cause heavy smoke or fire when subjected to high temperatures. **DO NOT** allow food spills with a high sugar or acid content (such as milk, tomatoes, sauerkraut, fruit juices or pie filling) to remain on the surface as they may leave a dull spot even after cleaning.
- Clean any soil from the oven frame, the door liner outside the oven door gasket and the small area at the front center of the oven bottom. These areas heat sufficiently to burn soil on. Clean with soap and water.

**NOTE:** Prior to setting the Self-Clean cycle, any spills remaining on the oven bottom should be removed.

Some models have a recessed well for the bake element.

On these models, the bake element is designed to be tilted up using your hand from the front of the bake element. This will allow easier access to the oven bottom for cleaning. Be careful not to raise the element more than 4 or 5 inches from the resting position.

#### To set the controls for a self-clean cycle:

For satisfactory results use a 2 hour cycle for **light soils** and a 3 hour cycle for **average to heavy soils**.

1. Be sure the clock shows the correct time of day.
2. Press **Clean**. "— — —" appears in the display.
3. Press the **Up Arrow** until "3:00" appears in the display for a 3 hour cycle, or press the **Down Arrow** until "2:00" appears in the display for a 2 hour cycle.
4. As soon as the **Up Arrow** or **Down Arrow** is released, "CLN" appears in the display.
5. As soon as the controls are set, the motor driven lock will begin to close automatically and the "LOCK" indicator light will flash. **DO NOT** open the door while the light is flashing (it takes about 15 seconds for the oven door to lock).
6. The "LOCK" light will glow until the cleaning cycle is completed or cancelled, and the oven temperature has cooled.

#### When the self-clean cycle is completed:

1. The time of day or "END" will appear in the display window and the "Clean" and "LOCK" light will continue to glow.
2. Once the oven has cooled down for about 1 hour and the "LOCK" light has gone out, the oven door can be opened.
3. If "End" is in the display and the "Clean" indicator remains on, press **Clear Off**. The time of day will appear in the display.

**NOTE:** When the oven is cool, wipe away any residue or powdered ash with a damp cloth or paper towel.

#### Stopping or interrupting a self-cleaning cycle:

1. Press **Clear Off**.
2. Once the oven has cooled down for about 1 HOUR and the "LOCK" light has gone out, the oven door can be opened.

3. Restart the self-clean cycle once all conditions have been corrected.

**CAUTION:** Use care when opening the oven door after the self-cleaning cycle. Stand to the side of the oven when opening the door to allow hot air or steam to escape.

**CAUTION: DO NOT** force the oven door open. This can damage the automatic door locking system. Use caution when opening the door after the self-cleaning cycle is completed. The oven may still be VERY HOT.

#### How the ES 300 control system works:

**CAUTION: NEVER ATTEMPT TO REMOVE EITHER THE BAKE OR BROIL ELEMENT WITHOUT DISCONNECTING ELECTRICAL POWER FROM THE RANGE. ELECTRICAL POWER IS CONNECTED TO THE ELEMENTS WHENEVER ELECTRICAL POWER IS CONNECTED TO THE RANGE.**

The ES 300 electronic oven control system is made up of four parts that control the bake and broil elements, the speed bake fan in the oven, and the locking of the door in the self-clean cycle.

1. Electronic oven control.
2. Oven temperature sensor.
3. Oven door lock mechanism.
4. Speed bake switch.

#### Bake:

When the bake pad is touched, and a temperature is set with the up or down arrows, the bake relay on the board closes. This connects one side of the line to the bake element, and the preheat and oven lights on the control glow. In the tip of the oven sensor is a positive thermistor that increases in resistance as the oven temperature increases. The microprocessor in the EOC reads the resistance of the oven sensor and compares it with a programmed temperature set into the control. When the resistance of the oven sensor indicates the temperature in the oven is about 10 degrees above the programmed temperature, the microprocessor opens the relay which removes power from the element. When power is removed from the element the oven temperature begins to lower. As the oven temperature lowers, the resistance of the oven sensor decreases. When the oven drops to about 10 degrees below the programmed temperature the resistance of the sensor tells the microprocessor to close the relay contacts, and provide power to the

element. After the first cycle, the preheat light is turned off. Then whenever the oven calls for heat the control cycles the broil element on for seven seconds and the bake element on for fifty three seconds out of every minute. This provides top heat during the bake cycle. The two elements are never on at the same time.

**NOTE: Oven controls may have a temperature swing of more or less than 20 degrees. The important thing is the average temperature in the oven. The average temperature in the center of the oven should be within 10 degrees of the programmed temperature.**

#### **Time bake:**

The time bake function allows the oven to be programmed to stop baking at a set time, or to delay the start and stop baking at a set time. The stop time cannot be set for more than 11 hours and 59 minutes ahead of the time of day.

#### **Broil:**

When the broil pad is touched, and High or Low is set with the up or down arrows, the broil relay on the board closes. This connects one side of the line to the broil element. In the tip of the oven sensor is a positive thermistor that increases in resistance as the oven temperature increases. The microprocessor reads the resistance of the oven sensor, and compares it with the programmed temperature set into the control. Usually you do not want the broil element to cycle, so the oven door is opened to the broil stop position. If the door is not opened the broil element will cycle when the set temperature is reached.

#### **Speed bake:**

Speed bake operates the same as the bake cycle. However, when the speed bake switch is touched the contacts of the speed bake relay on the EOC close providing line to neutral (120 VAC) to the speed bake fan in the oven. This fan operates continuously until the clear/off is touched. If the oven door is open during a speed bake operation the fan stops, but it restarts when the door is closed.

#### **Clean:**

With the oven door closed, contacts COM to NO of the oven door switch close. Then when the clean pad is touched and a clean time is set the door lock relay on the electronic oven control closes providing line to neutral voltage (120 VAC) to the lock motor. "CLN" appears in the display and the lock indicator light blinks. The lock motor starts to rotate, closing the contacts of the door

lock switch. When the motor rotates one half turn the contacts of the door lock switch reopen sending a signal to the EOC that the door is locked, and to open the contacts of the lock relay. The lock indicator light then glows steady and the EOC closes the bake relay providing power to the bake element. The clean temperature is preset into the EOC at around 860° F. It takes about 45 minutes for the oven to reach 860° F. When the temperature is reached the control cycles the bake element off and on to maintain the temperature until the clean time is completed. When the clean time is completed the EOC removes power from the bake element and the oven cools down. When the temperature in the oven goes below 500° F the control closes the contacts of the lock relay. The lock motor then turns 180 degrees closing and reopening the contacts of the lock switch and unlocking the door. The open contacts of the lock switch tells the control that the door is unlocked and to open the contacts of the lock relay and turn the lock indicator light off.

#### **Calibration:**

##### **To check oven calibration:**

1. Place a thermometer or thermocouple in the center of the oven.
2. Program the oven for bake and the temperature to 350° F. Allow the oven to cycle three times.
3. Average the highest and lowest readings. The average should be within 10° of 350° F.

##### **To change the calibration:**

1. Touch the bake pad on the control, and using the up arrow set the oven temperature to maximum (550° F).
2. Within 3 seconds touch and hold the bake pad (about 5 seconds) until "00" appear in the display.

**NOTE: If any numbers other than "00" appear in the display, the control has been previously calibrated in the field.**

3. By using the up or down arrows the calibration temperature can be changed + or - 35° F.
4. When the desired calibration is reached, touch the cancel pad to return the control to normal operation.

## Troubleshooting:

The ES 300 has some self diagnostics built into the microprocessor to help in troubleshooting the system. When a failure occurs one of three codes will appear in all the display windows; F1, F3 and F9.

### F1 code:

An F1 indicates a malfunction in the control itself, and the control should be replaced.

### F3 code:

An F3 indicates a defective sensor, electronic oven control or the wiring in between. To determine which part is defective:

1. Disconnect the 15 pin plug from the back of the oven control that connects the sensor to the oven control.
2. With an Ohmmeter measure the resistance between pins 12 and 13 in the plug (not on the control board). If the meter reads around the value of the oven temperature sensor shown in the below resistance chart, the oven control is defective. If the meter reads less than 800 Ohms or more than 3000 Ohms, go to step 3.

RTD SCALE	
Temperature (°F)	Resistance (ohms)
32 ± 1.9	1000 ± 4.0
75 ± 2.5	1091 ± 5.3
250 ± 4.4	1453 ± 8.9
350 ± 5.4	1654 ± 10.8
450 ± 6.9	1852 ± 13.5
550 ± 8.2	2047 ± 15.8
650 ± 9.6	2237 ± 18.5
900 ± 13.6	2697 ± 24.4

3. Disconnect the harness from the oven sensor and measure the resistance of the oven sensor. If the reading is less than 800 Ohms or more than 3000 Ohms, the oven sensor is defective. If the reading is correct with the chart, the harness is defective.

### F9 code:

An F9 code indicates the control has detected a problem with the motor door latch assembly. Check the contacts of the lock switch, wiring to the lock motor assembly, and the lock motor.

### Control will not program:

If the control will not program check for an open sensor circuit. If the sensor circuit is good replace the control.

### Time bake does not operate:

If the normal bake feature operates but the time bake feature does not operate check to be sure it is being programmed correctly. If so, replace the EOC.

### Blank Display:

If the display on the oven control is blank and the range is connected to electrical power:

1. Go to the back of the control and measure the voltage drop between terminal L1 and neutral. If the meter reads line to neutral voltage (120 VAC) the control is defective. If the meter reads zero the wiring in the range is defective.

### No heat:

If the control appears to be operating normally, but the bake element does not heat:

1. Go to the back of the oven control and measure the voltage drop between terminals BA and neutral with the control not programmed (clock operating only). If the meter reads line to neutral (120VAC) the control is defective. If the meter reads zero the bake element or the wiring to the bake element is defective. Go to step 2.
2. Remove the back from the range to gain access to the terminals of the bake element. Program the oven control for bake and measure the voltage drop across the terminals of the bake element. If the meter reads line to line voltage (240VAC) the element is defective. If the meter reads zero the wiring to the element is open.

If the control appears to be operating normally, but the broil element does not heat:

1. Go to the back of the oven control and measure the voltage drop between terminals BR and neutral with the control not programmed (clock operating only). If the meter reads line to neutral (120VAC) the control is defective. If the meter reads zero the broil element or the wiring to the broil element is defective. Go to step 2.
2. Remove the back from the range to gain access to the terminals of the broil element. Program the oven control for broil and measure the voltage drop across the terminals of the broil element. If the meter reads line to line voltage (240VAC) the element is defective. If the meter reads zero the wiring to the element is open.

**Oven door does not lock when the oven is programmed for clean:**

1. Remove power from the range, go to the back of the control and disconnect the 15 pin plug. Measure the resistance between pins 5 and 6 of the 15 pin plug (not on the EOC). If the meter reads infinity the lock motor or the wiring to the lock motor is defective. If the meter reads around 1500 ohms go to step 2.
2. Measure the resistance between pins 9 and 11 of the 15 pin plug with the oven door closed. If the meter reads infinity the door switch or the wiring to the door light switch is defective. If the meter reads zero go to step 3.
3. Measure the resistance between pins 9 and 10 of the 15 pin plug. If the meter reads infinity the lock switch or the wiring to the lock switch is defective. If the meter reads zero the control is defective.

**Lock motor runs continuously:**

1. With the door in the unlock position, remove power from the range. Go to the back of the control and disconnect the 15 pin plug from the control. With an Ohmmeter measure the resistance between pins 9 and 10 of the 15 pin plug (not on the EOC). If the meter reads zero the lock switch or the wiring to the lock switch is defective. If the meter reads infinity go to step 2.
2. Depress the arm of the lock switch, and measure the resistance between pins 9 and 10 of the 15 pin plug. If the meter reads infinity the lock switch or the wiring to the lock switch is defective. If the meter reads zero the control is defective.

**NOTE: Always check the cam arm relationship.**

**Oven door locks when the oven is programmed for clean but the oven does not heat:**

1. If the oven operates normally in bake, replace the control.

**Door latch is partly closed with door open, cannot close door:**

1. Program the oven for self-clean, and hold in on the door switch for 30 seconds. Touch cancel and hold door switch in for 30 seconds. The lock motor should lock and unlock the door.

**Fan in oven does not run when speed bake switch is turn on:**

1. Remove power from the range and set the speed bake switch to on. Disconnect the 15 pin plug from the oven control and measure the resistance between pins 14 and 15 (not on the EOC). If the meter reads infinity, the speed bake switch or the wiring to the speed bake switch is defective. If the meter reads zero go to step 2.
2. Measure the resistance between pins 9 and 11 of the 15 pin plug. If the meter reads infinity, the door switch or the wiring to the door switch is defective. If the meter reads zero go to step 3.
3. Spin the motor blade. If the blade turns hard or doesn't move, remove the motor and check for an obstruction. If the blade spins free, measure the resistance between pins 3 and 5. If the meter reads infinity, the motor or the wiring to the motor is defective. If the meter reads around 15 Ohms replace the control.

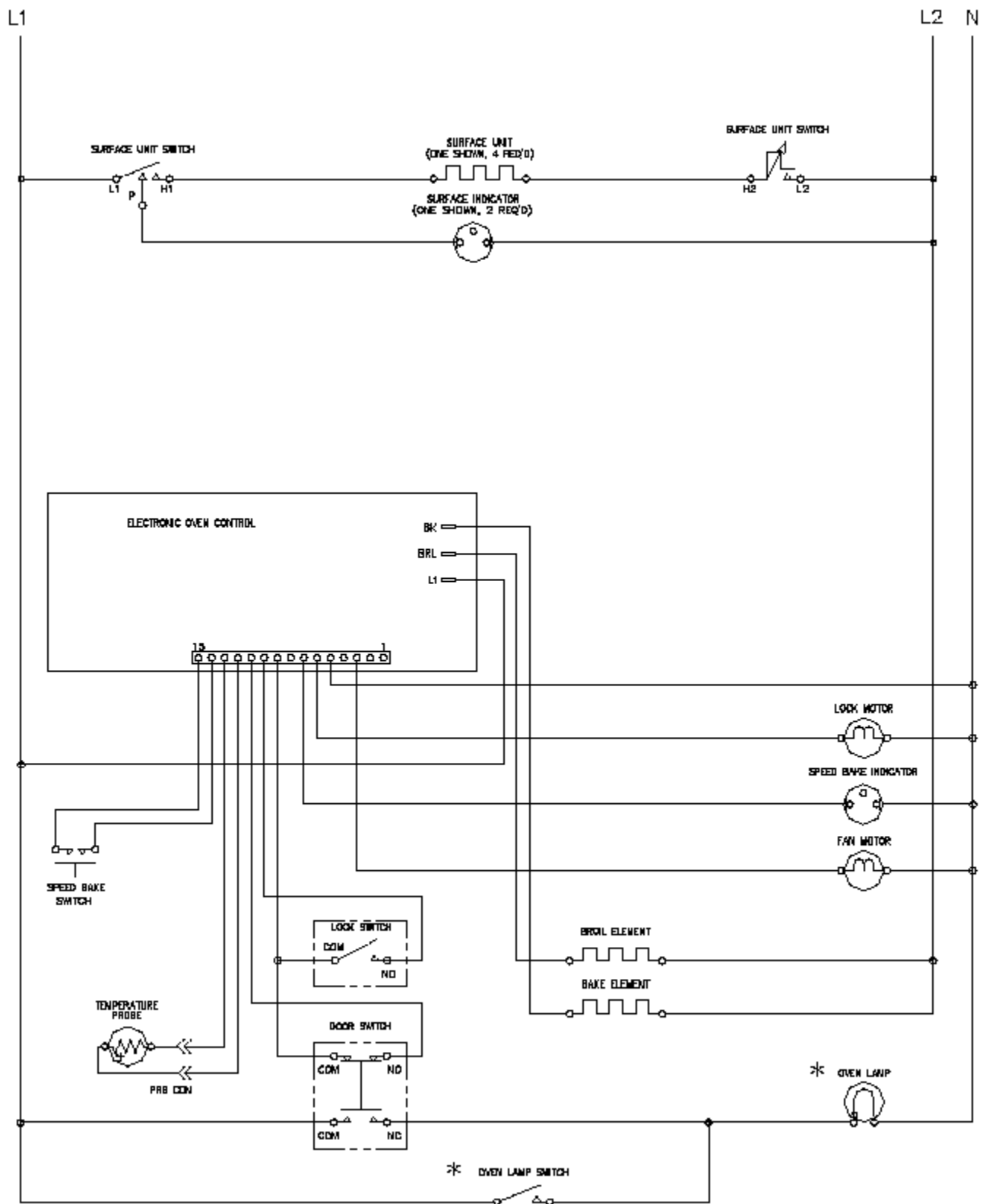

SAMPLE SCHEMATIC FOR THE ES 300 CONTROL SYSTEM

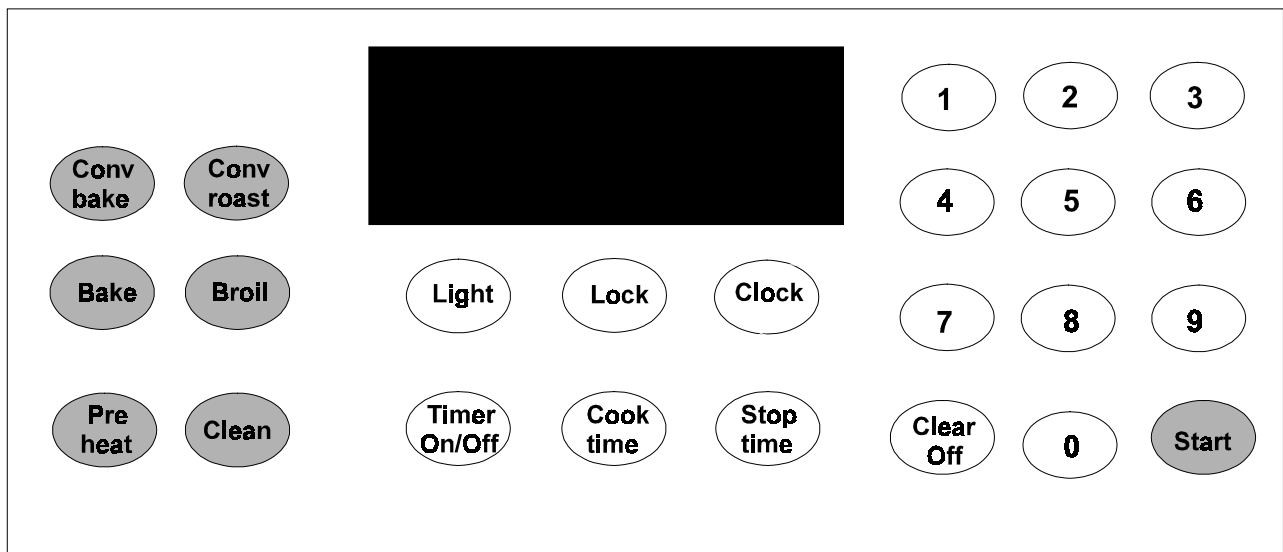

### The ES 400 Electronic Oven Control System:

The ES 400 electronic oven control system is used to control ovens on self-cleaning model ranges with the convection feature.

### How to program the ES 400:

The oven can be programmed to: Bake, Time Bake, Broil, Convection Bake, Self-Clean, Continuous Bake, and set for Oven Lockout.

### Clock:

The clock may be set for 12 or 24 hour time of day operation. The clock has been preset at the factory for 12 hour operation. When the range is first plugged in or when the power supply to the range has been interrupted, the timer in the display will flash and **PF** (power failure) will appear in the display.

### To set the clock:

1. Press **Clock**. "CLO" will appear in the display.
2. Example for 1:30. Press the numbers 1 3 0 to set the time of day to 1:30. "CLO" will disappear after 4 seconds and the clock will start. Or you may press **Start**. "CLO" will disappear and the clock will start.

### Changing between 12 or 24 hour time of day display:

1. Press and hold **Clock** for 6 seconds and a beep will sound.
2. The display will show **12:00** to indicate the 12 hour time of day operation is active.

3. Press **Clean** to toggle between the 12 and 24 hour time of day display. The display will show either **12:00** or **24:00**.
4. Press **Start** to accept the change or press **Clear/Off** to reject the change.
5. Reset the correct time as described in **To set the clock**.

Please note that if the 24 hour time of day mode was chosen, the clock will now display time from 0:00 through 24:00 hours.

### Continuous bake or 12 hour energy saving:

The oven control has a factory preset built-in 12 hour energy saving feature that will shut off the oven if the oven control is left on for more than 11 hours and 59 minutes. The oven can be programmed to override this feature for continuous baking.

### To set the control for continuous bake or 12 hour energy saving:

1. Press and hold **Timer On/Off** for 7 seconds, ":-—" or "24" will appear in the display and the control will beep once.
2. Press **Clean** to toggle between the 12 hour energy saving and continuous bake features.

**NOTE:** "12" in the display indicates the control is set for the 12 hour energy saving mode and ":-—" indicates the control is set for the continuous bake feature.

3. Press **Start** to accept the change or press **Clear/Off** to reject the change.

### Minute timer:

The minute timer serves as an extra timer in the kitchen that will beep when the set time has run out. It does not start or stop cooking. The minute timer can be used during any of the other oven functions. The minute timer can be set for any amount of time from 1 minute to 11 hours 59 minutes in the 12 or 24 hour modes.

#### To set the minute timer:

1. Press **Timer On/Off**, “0:00” and “TIMER” will flash in the display.
2. Push the number pads to set the desired time in the display. Press **Start**, the time will begin to count down and “TIMER” will glow in the display.  
Note: If **Start** is not pressed the timer will return to the time of day.
3. When the set time has run out, “END” will show in the display and beep 3 times, every 60 seconds, until **Timer On/Off** is pressed.

#### To change the minute timer while it is in use:

1. Press **Timer On/Off** and enter the new time using the number pads. Then press **Start** to start with the new time.

#### To cancel the minute timer before the set time has run out:

1. Press and hold **Timer On/Off**. The display will return to the time of day.

### Oven lockout feature:

The Oven Lockout feature prevents the oven from being accidentally turned on. It does not disable the clock, minute timer, or surface elements. It disables the oven light switch, but the oven light will turn on if the oven door is opened.

#### To activate the oven lockout:

1. Press and hold **Lock** for three seconds.
2. After 3 seconds the lock icon light (🔒) will come on and “DOOR LOCKED” will flash in the display. Once the oven door is locked the “DOOR LOCKED” indicator will quit flashing and remain on along with the lock icon light.

#### To reactivate oven operation:

1. Press and hold **Lock** for three seconds. A beep

will sound and the lock icon light (🔒) will clear and the time will be shown. The “DOOR LOCKED” will continue to flash until the oven door has completely unlocked.

2. The oven control may then be programmed for all operations.

### Temperature display - Fahrenheit or Celcius:

The oven control can be programmed to display temperatures in Fahrenheit or Celsius. The range has been preset at the factory to display in Fahrenheit.

#### To change the temperature from °F to °C or from °C to °F:

1. Identify which display your control is set for now. To tell if your range is set for Fahrenheit or Celsius press **Broil** and hold for 7 seconds. A beep will then sound. If “F” appears in the display it is set to show temperatures in Fahrenheit. If “C” appears in the display it is set to show temperatures in Celsius.
2. Press **Clean** to toggle between the Fahrenheit to Celsius display mode. The display will show either “F” (Fig. 4) or “C”.
3. Press **Start** to accept the change or press **Clear Off** to reject the change.

### Silent control operation:

The silent operation feature allows the control to be operated without sounds or beeps whenever necessary. If desired the control can be programmed for silent operation and later returned to operating with all the normal sounds and beeps.

#### To change control from normal sound operation to silent control operation:

1. Identify which sound operation your control is set for now. To tell if your range is set for normal or silent operation press and hold **Stop Time** for 7 seconds. “DELAY” will flash in the display. If “:SP” appears, the control will operate with normal sounds and beeps. If “:—” appears, the control is in the silent operation mode.
2. Press **Clean** to toggle between the normal sound operation and silent operation mode. The display will show either “:SP” or “:—”.
3. Press **Start** to accept the change or press **Clear Off** to reject the change.



### Preheat:

The preheat mode will bring the oven up to temperature and then beep to let you know when to add your food. Preheating the oven is recommended when baking breads and cakes. The oven can be programmed to preheat at any temperature from 170° F to 550° F.

#### To set the preheat temperature:

1. Arrange oven racks.
2. Press **Preheat**. “—°” and “BAKE” will show in the display.
3. Press the numbers to set the temperature you want the oven to attain in preheat. The set temperature and “BAKE” will show in the display.
4. Press **Start**. “PRE” and “BAKE” will show in the display as the oven heats and reaches the set temperature.

**NOTE:** After the oven has reached the desired temperature the control will beep and the “PRE” light will turn off and oven temperature will be displayed. If the beep was missed, a quick glance at the display with the “PRE” missing and the oven temperature shown in its place, is a good way to check that the oven has reached the preheat temperature. Once the oven has preheated, you may place food in the oven immediately. The “BAKE” light will stay on.

5. Press **Clear Off** when baking is complete or to cancel preheat.

#### To change the preheat temperature while the oven is preheating:

1. While preheating, press **Preheat**. “—°” and “BAKE” will show in the display.
2. Enter the new preheat temperature. Press the numbers for the new set temperature. The new set temperature and “BAKE” will show in the display.
3. Press **Preheat**. “PRE” and “BAKE” will show in the display as the oven heats and reaches the new set temperature.
4. When baking is complete press **Clear Off**.

### Bake:

Use this mode when preheating is not necessary, such as when roasting or cooking casseroles. The oven can

be programmed to bake at any temperature from 170° F to 550° F (the sample below is for 350° F).

#### To set the bake temperature:

1. Arrange oven racks and place food in oven.
2. Press **Bake**, “—°” will show in the display.
3. Press 3 5 0 . “350°” will flash and “BAKE “ will show in the display.
4. Press **Start**. “BAKE” and “350°” oven temperature will show in the display.
5. Press **Clear Off** to stop baking or to cancel bake at any time.

#### To change the bake temperature:

(example 350° F to 425° F)

1. After the oven has already been set to bake at 350° F and should the temperature need to be changed to 425° F, press **Bake** and “—°” will show in the display. Then press 4 2 5 . “425°” and “BAKE” will show in the display.
2. Press **Start**. “BAKE” and the new oven temperature will show in the display.

#### Timed bake:

**COOK TIME** or **STOP TIME** control the Time Bake operation. The automatic timer will turn the oven off at the time you select in advance.

**CAUTION:** Use caution with the Timed Bake feature to cook cured or frozen meats and most fruits and vegetables. Foods that can easily spoil such as milk, eggs, fish, meat or poultry, should be chilled in the refrigerator first. Even when chilled, they should not stand in the oven for more than 1 hour before cooking begins, and should be removed promptly when cooking is completed. Eating spoiled food can result in sickness from food poisoning.

#### To program the oven to begin baking immediately and to shut off automatically:

(example to bake at 350° F for 50 minutes)

1. Be sure that the clock shows the correct time of day.
2. Arrange oven rack(s) and, if roasting or cooking a casserole, place the food in the oven.
3. Press **Bake**, “—°” will show in the display.

- Press 3 5 0 . “350°” will flash and “BAKE” will show in the display.
- Press **Start** . “350°” and “BAKE” will show in the display.
- Press **Cook Time** . “TIMED” will flash; “BAKE”, “00:00” and “350°” will show in the display.
- Enter the desired baking time using the number pads pressing 5 0 . “TIMED” will flash and “BAKE”, “00:50” and “350°” will show in the display.

**NOTE:** Baking time can be set for any amount of time from 1 minute to 11 hours and 59 minutes (maximum time for both 12 or 24 hour display modes).

- Press **Start** . Both the “TIMED” and “BAKE” icons will remain on in the display. Once Timed Bake has started, the current time will return in the display.

**NOTE:** Once Timed Bake is activated, press **Cook Time** to display the cook time remaining in the Timed Bake mode.

- Press **Clear Off** when baking is complete or at any time to cancel the Timed Bake mode.

#### Delay time bake - cook time and stop time:

The automatic timer will turn the oven **on and off** at the time you select in advance.

#### To program the oven for a delayed start time and to shutoff automatically:

(example bake at 350° F for 50 minutes finishing at 5:30)

- Be sure that the clock shows the correct time of day.
- Arrange oven rack(s) and, if roasting or cooking a casserole, place the food in the oven.
- Press **Bake**, “—” will show in the display.
- Press 3 5 0 . “350°” will flash and “BAKE” will show in the display.
- Press **Start** . “350°” and “BAKE” will show in the display.
- Press **Cook Time** . “TIMED” will flash; “BAKE”, “00:00” and “350°” will show in the display.
- Enter the desired baking time using the number

pads pressing 5 0 . “TIMED” will flash and “BAKE”, “00:50” and “350°” will show in the display.

**NOTE:** Baking time can be set for any amount of time from 1 minute to 11 hours and 59 minutes (maximum time for both 12 or 24 hour display modes).

- Press **Start** . “TIMED, BAKE” and “350°” will appear.
- Press **StopTime** . Enter the desired stop time using the number pads 5 3 0 .
- Press **Start** . Once Timed Delay Bake has started, the set oven temperature will disappear. “TIMED”, “DELAY” and “BAKE” and the current time of time will show in the display.

**NOTE:** Once Timed Bake is activated, press **Cook Time** to display the cook time remaining in the Timed Bake mode. Press **Clear Off** when baking has completed or at any time to cancel the delayed timed bake mode.

When the set bake time runs out:

- “End” will appear in the display window and the oven will shut off automatically.
- The control will beep 3 times. The control will continue to beep 3 times each minute until **Clear Off** is pushed.

#### To broil:

When broiling, heat radiates downward from the oven broil element for even coverage. The broil feature is pre-set to start broiling at 550° F. however, the broil feature temperature may be set between 400° F and 550° F.

**CAUTION: DO NOT use the pan without its insert.**

**CAUTION: DO NOT cover the insert with foil. The exposed grease could ignite. Should an oven fire occur, leave the oven door closed and turn off the oven. If the fire continues, throw baking soda on the fire or use a fire extinguisher. DO NOT put water or flour on the fire. Flour may be explosive and water can cause a grease fire to spread and cause personal injury.**

#### To set the oven to broil:

(example 550° F)

- Place the insert on the broiler pan, then place the food on the insert. **DO NOT** use the broiler pan without the insert. **DO NOT** cover the broiler insert with aluminum foil. The exposed fat could ignite.

2. Arrange oven rack and place the pan on the oven rack. Be sure to center the broiler pan directly under the broil burner. Open the oven door to the broil stop position.
3. Press **Broil**. “**BROIL**” will flash and “—°” appear in the display.
4. Press 5 5 0 . “**BROIL**” will flash and “**550°**” appear in the display.
5. Press **Start**. The oven will begin to broil. “**BROIL**” and “**550°**” appear in the display.
6. Broil on one side until food is browned; turn and cook on the second side. Season and serve.

**NOTE:** Always pull the rack out to the stop position before turning or removing food.

7. The “**BROIL**” light in the display will stay.
8. To cancel broiling or when broiling is complete press **Clear Off**.

#### Convection bake:

**To set the convection bake feature:**  
(example 350° F)

1. Arrange oven racks and place food in oven.
2. Press **Conv Bake**. “**CONV BAKE**” icon will flash and “—°” will show in the display.
3. Press 3 5 0 . “**CONV BAKE**” icon will flash and “**350°**” will show in the display.
4. Press **Start**. The “**CONV BAKE**” icon will remain on. Also the “**350°**” oven temperature and the oven icon will show in the display.  
**NOTE:** The convection fan will come on a short time after the oven has been set for convection bake. The oven icon display will begin rotating indicating that the convection fan is operating.
5. Press **Clear Off** to stop baking or to cancel bake at any time.

#### Convection roast:

The convection roast feature is used when cooking with meat. This feature has been designed to give optimum cooking performance for roasting meats.

**To set the convection roast feature:**  
(example 350° F)

1. Arrange interior oven racks and place food in oven.
2. Press **Conv roast**. “**MEATS**” will flash and “—°” will be displayed.
3. Press 3 5 0 . “**MEATS**” will flash and “**350°**” will appear in the display.
4. Press **Start**. “**MEATS**” and “**350°**” will appear in the display. The convection fan icon will come on.
5. Press **Clear Off** to stop convection roast, or to cancel convection roast at any time.

#### Self-clean cycle:

When planning to use the oven directly after a self-clean cycle remember to allow time for the oven to cool down and the oven door to unlock. This normally takes about one hour. Therefore, a 3 hour self-clean cycle will actually take about 4 hours to complete.

It is recommended to use a 2 hour self-clean cycle for **light soils**, a 3 hour cycle for **average soils**, and a 4 hour cycle for **heavy soils** (to assure satisfactory results).

**CAUTION: During the self-cleaning cycle, the outside of the range can become very hot to the touch. DO NOT leave small children unattended near the appliance; they may be burned if they touch the hot oven door surfaces.**

**CAUTION: DO NOT force the oven door open. This can damage the automatic door locking system. Use care when opening the oven door after the self-cleaning cycle. Stand to the side of the oven when opening the door to allow hot air or steam to escape. The oven may still be very hot.**

**To set the controls for the self-cleaning cycle to start immediately and shut off automatically:**

1. Be sure the clock shows the correct time of day and the oven door is closed.
2. Press **Clean**. “**CLEAN**” will flash and “**3:00**” will show in the display. If a 2 or 4 hour clean is desired use the number pads to enter the time. Set the cleaning time based on the amount of soil you have—light, average or heavy.
3. Press **Start**. The “**DOOR LOCKED**” icon will flash; “**CLEAN**” icon and the letters “**CLN**” will remain on in the display.
4. As soon as the controls are set, the motor driven

oven door lock will begin to close automatically and once the door has been locked the “**DOOR LOCKED**” indicator light will quit flashing and remain on . Also the oven icon will show in the display.

**NOTE:** It takes about 15 seconds for the oven door lock to close.

#### **When the self-clean cycle is completed:**

1. Only the time of day and the “**DOOR LOCKED**” icon will remain in the display.
2. Once the oven has cooled down for approximately 1 HOUR, and the word “**DOOR LOCKED**” shown in the display has gone out, the oven door can then be carefully opened.

#### **Stopping or interrupting a self-cleaning cycle:**

If it becomes necessary to stop or interrupt a self-cleaning cycle due to excessive smoke or fire in the oven:

1. Press **Clear Off**.
2. Once the oven has cooled down for approximately 1 HOUR and the “**DOOR LOCKED**” icon is no longer displayed, then the oven door may be carefully opened.

#### **How the ES 400 operates:**

**CAUTION: NEVER ATTEMPT TO REMOVE EITHER THE BAKE OR BROIL ELEMENT WITHOUT DISCONNECTING ELECTRICAL POWER FROM THE RANGE. ELECTRICAL POWER IS CONNECTED TO THE ELEMENTS WHENEVER ELECTRICAL POWER IS CONNECTED TO THE RANGE.**

The ES 400 electronic oven control system is made up of three parts that control the bake and broil elements, and the locking of the door in clean.

1. Electronic oven control.
2. Oven temperature sensor.
3. Oven door lock mechanism.

#### **Preheat:**

When the preheat pad is touched and a temperature is entered with the number pads, the bake relay on the board closes, and connects one side of the line to the bake element. “PRE” and “BAKE” appear in the display. After the first cycle “PRE” disappears and the oven operates as in normal bake.

#### **Bake:**

When the bake pad is touched, and a temperature is entered with the number pads, the bake relay on the board closes, and connects one side of the line to the bake element. “BAKE” appears in the display. In the tip of the oven sensor is a positive thermistor that increases in resistance as the oven temperature increases. The EOC microprocessor reads the resistance of the oven sensor, and compares it with the programmed temperature set into the control. When the resistance of the oven sensor indicates temperature in the oven is about 10 degrees above the programmed temperature, the microprocessor opens the relay, which removes power from one side of the element. When power is removed from the element the oven temperature begins to lower. As the oven temperature lowers the resistance of the oven sensor decreases. When the oven drops to about 10 degrees below the programmed temperature, the resistance of the sensor tells the microprocessor to close the relay contacts, and once again provide power to the element. After the first cycle and whenever the oven calls for heat, the EOC cycles the broil element on for seven seconds and then the bake element on for fifty three seconds out of every minute. This provides top heat during the bake cycle. The two elements are never on at the same time.

**NOTE: Oven controls may have a temperature swing of more or less than 20 degrees. The important thing is the average temperature in the oven. The average temperature in the center of the oven should be within 10 degrees of the programmed temperature.**

#### **Time bake:**

The time bake function allows the oven to be programmed to stop bake at a set time, or to delay the start and stop baking at a set time. The stop time cannot be set for more than 11 hours and 59 minutes ahead of the time of day.

#### **Convection bake:**

When the convection bake pad is touched and a temperature is set, two things happen that do not happen in normal bake. The EOC automatically raises the oven temperature 15° F above the temperature that was manually set in the control. If the oven door is closed, the convection relay on the EOC closes, providing line to neutral voltage to the convection fan motor and the convection assist element. This relay remains closed until the program is canceled or is interrupted by the opening of the oven door. If interrupted by the opening of the oven door, the relay will automatically close when the door is closed.

### Convection roast:

Convection roast operates the same as convection bake except the control does not operate above the set temperature and the temperature differential is larger.

### Broil:

When the broil pad is touched, and a temperature is entered with the numbers between 400° F and 550° F. (usually 550° F) the broil relay on the board closes, and connects one side of the line to the broil element. In the tip of the oven sensor is a positive thermistor that increases in resistance as the oven temperature increases. The EOC microprocessor reads the resistance of the oven sensor, and compares it with the programmed temperature set into the control. Usually you do not want the broil element to cycle so the oven door is opened to the broil stop position. If the door is not opened the broil element will cycle when the set temperature is reached.

### Clean:

With the oven door closed, contacts COM to NO of the oven door switch close. Then when the clean pad is touched and a clean time is set the door lock relay on the electronic oven control closes providing line to neutral voltage (120 VAC) to the lock motor. The lock motor starts to rotate, closing the contacts of the door lock switch. When the motor rotates one half turn the contacts of the door lock switch reopen sending a signal to the EOC that the door is locked, and to open the contacts of the lock relay. The lock indicator light then glows steady and the EOC closes the bake relay providing power to the bake element. The clean temperature is preset into the EOC at around 860° F. It takes about 45 minutes for the oven to reach 860° F. When the temperature is reached the control cycles the bake element off and on to maintain the temperature until the clean time is completed. When the clean time is completed the EOC removes power from the bake element and the oven cools down. When the temperature in the oven goes below 500° F the control closes the contacts of the lock relay. The lock motor then turns 180 degrees closing and reopening the contacts of the lock switch and unlocking the door. The open contacts of the lock switch tells the control that the door is unlocked and to open the contacts of the lock relay and turn the lock indicator light off.

### Calibration:

To check oven calibration:

1. Place a thermometer or thermocouple in the center of the oven.
2. Program the oven for bake and the temperature to

350° F. Allow the oven to cycle three times.

3. Average the highest and lowest reading. The average should be within 10° F of 350° F.

### To change the calibration:

To adjust the oven temperature higher:

1. Press the **Bake pad** for 6 seconds. "0" will appear in the display.

**NOTE: If any numbers other than "0" appear in the display, the control has been previously calibrated in the field.**

2. To increase the temperature, use the number pads to enter the desired change. The temperature may be increased up to 35° F.
3. Press **Start** to accept the temperature change and the display will return to the time of day. Press **Clear Off** to reject the change if necessary.

To adjust the oven temperature lower:

1. Press the **Bake pad** for 6 seconds. "0" will appear in the display.
2. To decrease the temperature, use the number pads to enter the desired change and then press **Clean**. The temperature may be decreased up to 35° F. (NOTE: Pressing **CLEAN** allows the entry of negative degree change.)
3. Press **Start** to accept the temperature change and the display will return to the time of day. Press **Clear Off** to reject the change if necessary.

### Troubleshooting:

The ES 400 has some self diagnostics built into the microprocessor to help in troubleshooting the system. When a failure occurs one of three codes will appear in the display window: F1, F3, or F9.

#### F1 code:

An F1 indicates a malfunction in the EOC itself, and the control should be replaced.

#### F3 code:

An F3 indicates a defective sensor, electronic oven control or the wiring in between.

To determine which part is defective:

1. Disconnect the fifteen pin plug from the back of the oven control that connects the sensor to the oven control.
2. With an Ohmmeter, measure the resistance between pins 14 and 15 in the plug (not on the control board). If the meter reads around value of the oven temperature sensor resistance chart shown below, the oven control is defective. If the meter reads less than 800 Ohms or more than 3000 Ohms, go to step 3.

RTD SCALE	
Temperature (°F)	Resistance (ohms)
32 ± 1.9	1000 ± 4.0
75 ± 2.5	1091 ± 5.3
250 ± 4.4	1453 ± 8.9
350 ± 5.4	1654 ± 10.8
450 ± 6.9	1852 ± 13.5
550 ± 8.2	2047 ± 15.8
650 ± 9.6	2237 ± 18.5
900 ± 13.6	2697 ± 24.4

3. Disconnect the harness from the oven sensor and measure the resistance of the oven sensor. If the meter reads less than 800 Ohms or more than 3000 Ohms, the oven sensor is defective. If the reading is correct with the chart, the harness is defective.

#### **F9 code:**

An F9 code indicates the control has detected a problem with the motor door latch assembly. Check the contacts of the lock switch, wiring to the lock motor assembly, and the lock motor.

#### **Control will not program:**

If the EOC will not program check for an open sensor circuit. If the sensor circuit is good replace the control.

#### **Time bake does not operate:**

If the normal bake feature operates but the time bake feature does not operate, check to be sure it is being programmed correctly. If it is being programmed correctly, replace the control.

#### **Convection bake and convection roast:**

#### **Neither the fan motor or the assist element operates:**

1. Remove power from range. Go to the back of the electronic oven control and disconnect the 15 pin plug. With the oven door closed, measure

the resistance between pins 10 and 12 of the 15 pin plug (in the plug). If the meter reads open, check the door switch and the wiring from the electronic oven control to the door switch. If the meter reads zero go to step 2.

2. Measure the resistance between pins 5 and 7. If the meter reads around 10 Ohms the control is defective. If the meter reads infinity either the wiring to the fan motor and element is open or both the fan motor and the element are defective.

#### **If either convection bake or convection roast operate normally but the other does not:**

1. The EOC is defective.

#### **Fan motor does not operate:**

1. If the assist element is heating then the fan motor itself or the wiring to the fan motor is defective. Also check for a blocked fan blade.

#### **Assist element does not operate:**

1. If the convection fan is operating then the element itself or the wiring to the element is defective.

#### **Control does not operate in preheat:**

1. If the oven operates in bake but not preheat, the EOC is defective.

#### **Blank display:**

1. With the range connected to electrical power, go to the back of the control and measure the voltage drop between terminal L1 and neutral. If the meter reads line to neutral voltage (120 VAC), the control is defective. If the meter reads zero the wiring in the range is defective.

#### **Bake element does not heat:**

1. With the range connected to electrical power, go to the back of the oven control and measure the voltage drop between terminals BA and neutral with the control not programmed (clock operating only). If the meter reads line to neutral (120VAC) the control is defective. If the meter reads zero, the bake element or the wiring to the bake element is defective. Go to step 2.
2. Remove the back from the range to gain access to the terminals of the bake element. Program the oven control for bake and measure the voltage drop across the terminals of the bake element. If the meter reads

line to line voltage (240 VAC) the element is defective. If the meter reads zero the wiring to the element is open.

**Broil element does not heat:**

1. With the range connected to electrical power, go to the back of the oven control and measure the voltage drop between terminals BR and neutral with the control not programmed (clock operating only). If the meter reads line to neutral (120VAC) the control is defective. If the meter reads zero the broil element or the wiring to the broil element is defective. Go to step 2.
2. Remove the back from the range to gain access to the terminals of the broil element. Program the oven control for broil and measure the voltage drop across the terminals of the broil element. If the meter reads line to line voltage (240 VAC) the element is defective. If the meter reads zero the wiring to the element is open.

**Oven door does not lock when the oven is programmed for clean:**

1. Remove power from the range, go the back of the control and disconnect the 15 pin plug. Measure the resistance between pins 5 and 6 of the 15 pin plug (in the plug). If the meter reads infinity, the lock motor or the wiring to the lock motor is defective. If the meter reads around 1500 ohms go to step 2.
2. Measure the resistance between pins 9 and 11 of the 15 pin plug with the oven door closed. If the meter reads infinity, the door switch or the wiring to the door light switch is defective. If the meter reads zero go to step 3.
3. Measure the resistance between pins 9 and 10 of the 15 pin plug. If the meter reads infinity the lock switch or the wiring to the lock switch is defective. If the meter reads zero the control is defective.

**Lock motor runs continuously:**

- 1 With the door in the unlock position, remove power from the range. Go to the back of the control and disconnect the 15 pin plug from the control. With an Ohmmeter measure the resistance between pins 9 and 10 of the 15 pin plug (in the plug). If the meter reads zero the lock switch or the wiring to the lock switch is defective. If the meter reads infinity go to step 2.
- 2, Depress the arm of the lock switch, and measure the resistance between pins 9 and 10 of the 15 pin

plug. If the meter reads infinity the lock switch or the wiring to the lock switch is defective. If the meter reads zero the control is defective.

NOTE: Always check the cam arm relationship.

**Oven door locks but the oven does not heat:**

1. If the oven operates in normal bake replace the control.

**Door latch is partly closed with door open:**

1. Program the oven for self-clean, and hold in on the door switch for 30 seconds. Touch cancel and hold door switch in for 30 seconds. The lock motor should lock and unlock the door.

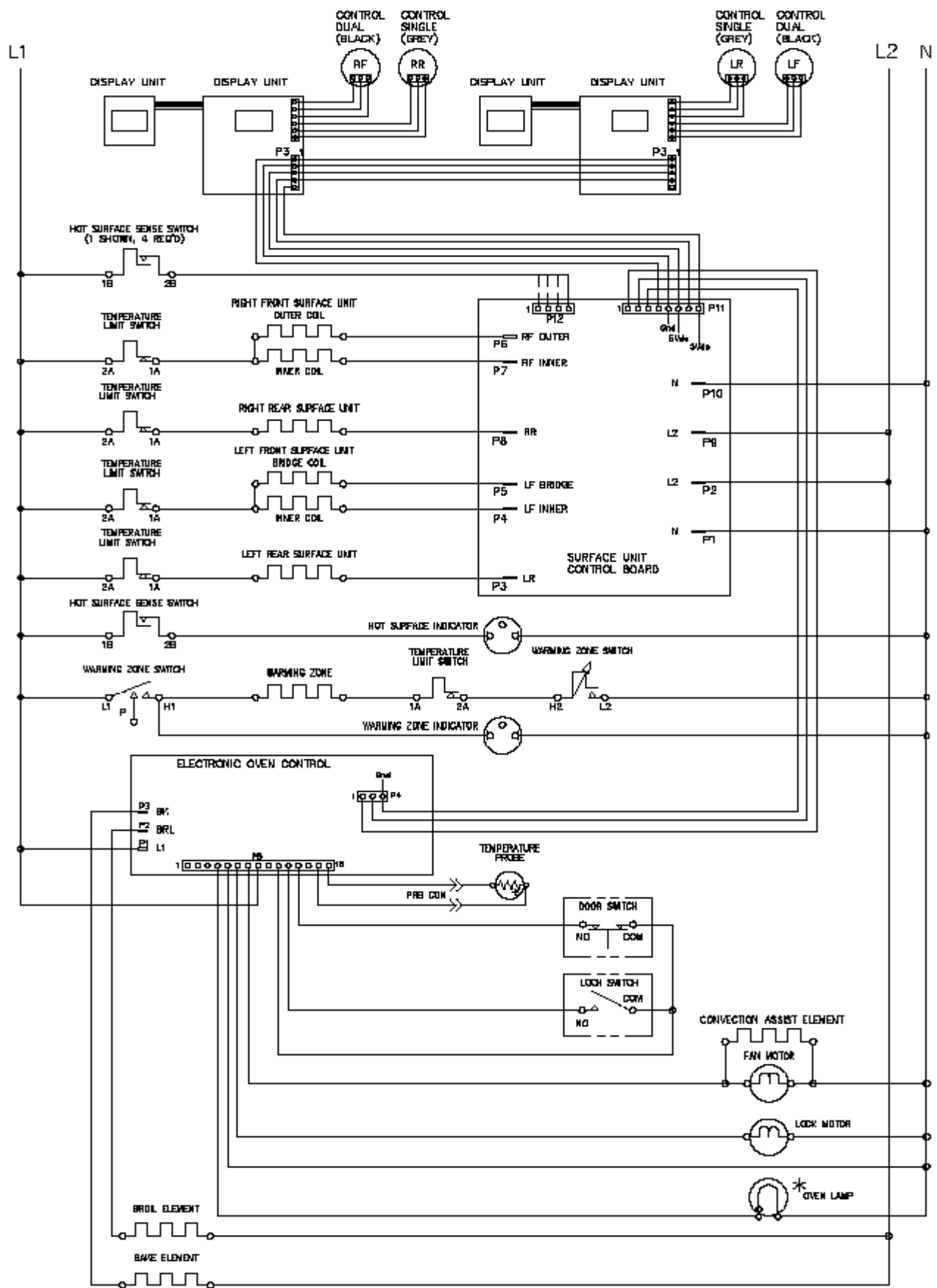

SAMPLE SCHEMATIC FOR THE ES 400 CONTROL SYSTEM



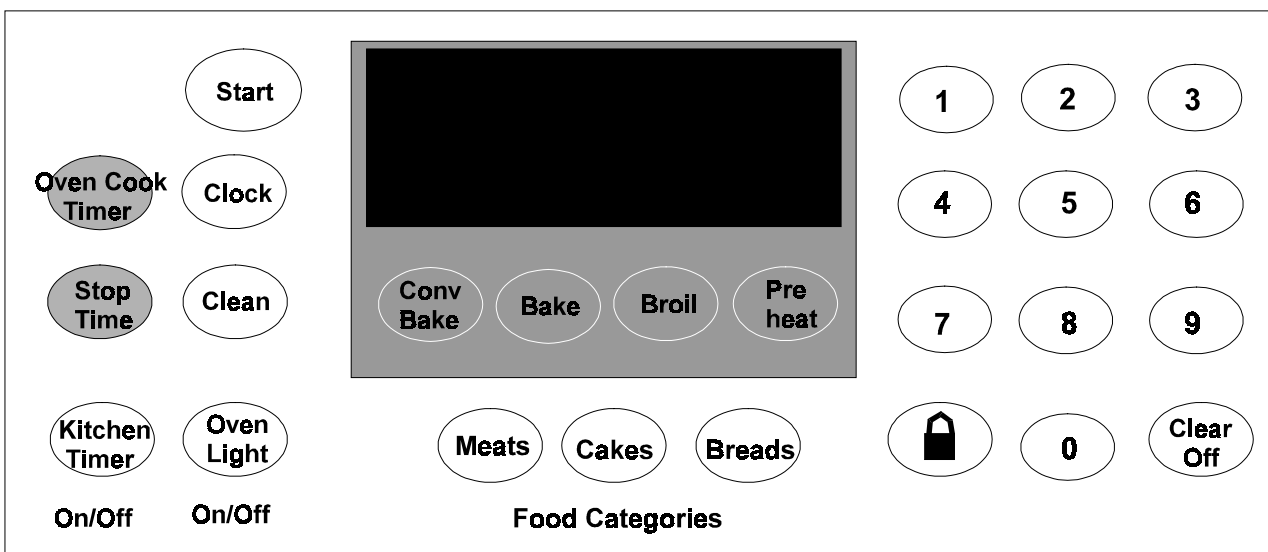

### The ES 450 Electronic Oven Control System:

The ES 450 electronic oven control system is used to control ovens on self-cleaning model ranges that have the convection and pre-programmed features.

### How to program the ES 450:

The oven can be programmed to: Bake, Time Bake, Broil, Convection Bake, Self-Clean, Continuous Bake, Preprogram Functions, and set for Oven Lockout.

#### Clock:

The clock may be set for 12 or 24 hour time of day operation. The clock has been preset at the factory for 12 hour operation. When the range is first plugged in or when the power supply to the range has been interrupted, the timer in the display will flash and **PF** (power failure) will appear in the display.

#### To set the clock:

1. Press **Clock** . “CLO” will appear in the display.
2. Example for 1:30. Press the numbers 1 3 0 to set the time of day to 1:30. “CLO” will disappear after 4 seconds and the clock will start. Or you may press **Start**. “CLO” will disappear and the clock will start.

#### Changing between 12 or 24 hour time of day display:

1. Press and hold **Clock** for 6 seconds and a beep will sound.
2. The display will show **12:00** to indicate the 12 hour time of day operation is active.

3. Press **Clean** to toggle between the 12 and 24 hour time of day display. The display will show either **12:00** or **24:00**.
4. Press **Start** to accept the change or press **Clear/Off** to reject the change.
5. Reset the correct time as described in **To set the clock**.

Please note that if the 24 hour time of day mode was chosen, the clock will now display time from 0:00 through 24:00 hours.

#### Continuous bake or 12 hour energy saving:

The oven control has a factory preset built-in 12 hour energy saving feature that will shut off the oven if the oven control is left on for more than 11 hours and 59 minutes. The oven can be programmed to override this feature for continuous baking.

#### To set the control for continuous bake or 12 hour energy saving:

1. Press and hold **Timer On/Off** for 7 seconds, “:—” or “:24” will appear in the display and the control will beep once.
2. Press **Clean** to toggle between the 12 hour energy saving and continuous bake features.

**NOTE:** “12” in the display indicates the control is set for the 12 hour energy saving mode and “:---” indicates the control is set for the continuous bake feature.

3. Press **Start** to accept the change or press **Clear/Off** to reject the change.

### Minute timer:

The minute timer serves as an extra timer in the kitchen that will beep when the set time has run out. It does not start or stop cooking. The minute timer can be used during any of the other oven functions. The minute timer can be set for any amount of time from 1 minute to 11 hours 59 minutes in the 12 or 24 hour modes.

#### To set the minute timer:

1. Press **Timer On/Off**, “0:00” and “TIMER” will flash in the display.
2. Push the number pads to set the desired time in the display. Press **Start**, the time will begin to count down and “TIMER” will glow in the display.  
Note: If **Start** is not pressed the timer will return to the time of day.
3. When the set time has run out, “END” will show in the display and beep 3 times, every 60 seconds, until **Timer On/Off** is pressed.

#### To change the minute timer while it is in use:

1. Press **Timer On/Off** and enter the new time using the number pads. Then press **Start** to start with the new time.

#### To cancel the minute timer before the set time has run out:

1. Press and hold **Timer On/Off**. The display will return to the time of day.

### Oven lockout feature:

The Oven Lockout feature prevents the oven from being accidentally turned on. It does not disable the clock, minute timer, or surface elements. It disables the oven light switch, but the oven light will turn on if the oven door is opened.

#### To activate the oven lockout:

1. Press and hold **Lock** for three seconds.
2. After 3 seconds the lock icon light (🔒) will come on and “DOOR LOCKED” will flash in the display. Once the oven door is locked the “DOOR LOCKED” indicator will quit flashing and remain on along with the lock icon light.

#### To reactivate oven operation:

1. Press and hold **Lock** for three seconds. A beep

will sound and the lock icon light (🔒) will clear and the time will be shown. The “DOOR LOCKED” will continue to flash until the oven door has completely unlocked.

2. The oven control may then be programmed for all operations.

### Temperature display - Fahrenheit or Celcius:

The oven control can be programmed to display temperatures in Fahrenheit or Celsius. The range has been preset at the factory to display in Fahrenheit.

#### To change the temperature from °F to °C or from °C to °F:

1. Identify which display your control is set for now. To tell if your range is set for Fahrenheit or Celsius press **Broil** and hold for 7 seconds. A beep will then sound. If “F” appears in the display it is set to show temperatures in Fahrenheit. If “C” appears in the display it is set to show temperatures in Celsius.
2. Press **Clean** to toggle between the Fahrenheit to Celsius display mode. The display will show either “F” (Fig. 4) or “C”.
3. Press **Start** to accept the change or press **Clear Off** to reject the change.

### Silent control operation:

The silent operation feature allows the control to be operated without sounds or beeps whenever necessary. If desired the control can be programmed for silent operation and later returned to operating with all the normal sounds and beeps.

#### To change control from normal sound operation to silent control operation:

1. Identify which sound operation your control is set for now. To tell if your range is set for normal or silent operation press and hold **Stop Time** for 7 seconds. “DELAY” will flash in the display. If “:SP” appears, the control will operate with normal sounds and beeps. If “:—” appears, the control is in the silent operation mode.
2. Press **Clean** to toggle between the normal sound operation and silent operation mode. The display will show either “:SP” or “:—”.
3. Press **Start** to accept the change or press **Clear Off** to reject the change.

## Preheat:

The preheat mode will bring the oven up to temperature and then beep to let you know when to add your food. Preheating the oven is recommended when baking breads and cakes. The oven can be programmed to preheat at any temperature from 170° F to 550° F.

### To set the preheat temperature:

1. Arrange oven racks.
2. Press **Preheat**. “—°” and “BAKE” will show in the display.
3. Press the numbers to set the temperature you want the oven to attain in preheat. The set temperature and “BAKE” will show in the display.
4. Press **Start**. “PRE” and “BAKE” will show in the display as the oven heats and reaches the set temperature.

**NOTE:** After the oven has reached the desired temperature the control will beep and the “PRE” light will turn off and oven temperature will be displayed. If the beep was missed, a quick glance at the display with the “PRE” missing and the oven temperature shown in its place, is a good way to check that the oven has reached the preheat temperature. Once the oven has preheated, you may place food in the oven immediately. The “BAKE” light will stay on.

5. Press **Clear Off** when baking is complete or to cancel preheat.

### To change the preheat temperature while the oven is preheating:

1. While preheating, press **Preheat**. “—°” and “BAKE” will show in the display.
2. Enter the new preheat temperature. Press the numbers for the new set temperature. The new set temperature and “BAKE” will show in the display.
3. Press **Preheat**. “PRE” and “BAKE” will show in the display as the oven heats and reaches the new set temperature.
4. When baking is complete press **Clear Off**.

## Bake:

Use this mode when preheating is not necessary, such as when roasting or cooking casseroles. The oven can

be programmed to bake at any temperature from 170° F to 550° F (the sample below is for 350° F).

### To set the bake temperature:

1. Arrange oven racks and place food in oven.
2. Press **Bake**, “—°” will show in the display.
3. Press 3 5 0 . “350°” will flash and “BAKE” will show in the display.
4. Press **Start**. “BAKE” and “350°” oven temperature will show in the display.
5. Press **Clear Off** to stop baking or to cancel bake at any time.

### To change the bake temperature:

(example 350° F to 425° F)

1. After the oven has already been set to bake at 350° F and should the temperature need to be changed to 425° F, press **Bake** and “—°” will show in the display. Then press 4 2 5 . “425°” and “BAKE” will show in the display.
2. Press **Start**. “BAKE” and the new oven temperature will show in the display.

## Timed bake:

**COOK TIME** or **STOP TIME** control the Time Bake operation. The automatic timer will turn the oven off at the time you select in advance.

**CAUTION:** Use caution with the Timed Bake feature to cook cured or frozen meats and most fruits and vegetables. Foods that can easily spoil such as milk, eggs, fish, meat or poultry, should be chilled in the refrigerator first. Even when chilled, they should not stand in the oven for more than 1 hour before cooking begins, and should be removed promptly when cooking is completed. Eating spoiled food can result in sickness from food poisoning.

### To program the oven to begin baking immediately and to shut off automatically:

(example to bake at 350° F for 50 minutes)

1. Be sure that the clock shows the correct time of day.
2. Arrange oven rack(s) and, if roasting or cooking a casserole, place the food in the oven.
3. Press **Bake**, “—°” will show in the display.

4. Press 3 5 0 . “350°” will flash and “BAKE” will show in the display.
5. Press **Start** . “350°” and “BAKE” will show in the display.
6. Press **Cook Time**. “TIMED” will flash; “BAKE”, “00:00” and “350°” will show in the display.
7. Enter the desired baking time using the number pads pressing 5 0 . “TIMED” will flash and “BAKE”, “00:50” and “350°” will show in the display.

**NOTE:** Baking time can be set for any amount of time from 1 minute to 11 hours and 59 minutes (maximum time for both 12 or 24 hour display modes).

8. Press **Start** . Both the “TIMED” and “BAKE” icons will remain on in the display. Once Timed Bake has started, the current time will return in the display.

**NOTE:** Once Timed Bake is activated, press **Cook Time** to display the cook time remaining in the Timed Bake mode.

9. Press **Clear Off** when baking is complete or at any time to cancel the Timed Bake mode.

#### **Delay time bake - cook time and stop time:**

The automatic timer will turn the oven **on and off** at the time you select in advance.

#### **To program the oven for a delayed start time and to shutoff automatically:**

(example bake at 350° F for 50 minutes finishing at 5:30)

1. Be sure that the clock shows the correct time of day.
2. Arrange oven rack(s) and, if roasting or cooking a casserole, place the food in the oven.
3. Press **Bake**, “—°” will show in the display.
4. Press 3 5 0 . “350°” will flash and “BAKE” will show in the display.
5. Press **Start** . “350°” and “BAKE” will show in the display.
6. Press **Cook Time**. “TIMED” will flash; “BAKE”, “00:00” and “350°” will show in the display.
7. Enter the desired baking time using the number

pads pressing 5 0 . “TIMED” will flash and “BAKE”, “00:50” and “350°” will show in the display.

**NOTE:** Baking time can be set for any amount of time from 1 minute to 11 hours and 59 minutes (maximum time for both 12 or 24 hour display modes).

8. Press **Start**. “TIMED, BAKE” and “350°” will appear.
9. Press **StopTime**. Enter the desired stop time using the number pads 5 3 0 .
10. Press **Start**. Once Timed Delay Bake has started, the set oven temperature will disappear. “TIMED”, “DELAY” and “BAKE” and the current time of time will show in the display.

**NOTE:** Once Timed Bake is activated, press **Cook Time** to display the cook time remaining in the Timed Bake mode. Press **Clear Off** when baking has completed or at any time to cancel the delayed timed bake mode.

When the set bake time runs out:

1. “End” will appear in the display window and the oven will shut off automatically.
2. The control will beep 3 times. The control will continue to beep 3 times each minute until **Clear Off** is pushed.

#### **To broil:**

When broiling, heat radiates downward from the oven broil element for even coverage. The broil feature is pre-set to start broiling at 550° F. however, the broil feature temperature may be set between 400° F and 550° F.

**CAUTION: DO NOT use the pan without its insert.**

**CAUTION: DO NOT cover the insert with foil. The exposed grease could ignite. Should an oven fire occur, leave the oven door closed and turn off the oven. If the fire continues, throw baking soda on the fire or use a fire extinguisher. DO NOT put water or flour on the fire. Flour may be explosive and water can cause a grease fire to spread and cause personal injury.**

#### **To set the oven to broil:**

(example 550° F)

1. Place the insert on the broiler pan, then place the food on the insert. **DO NOT** use the broiler pan without the insert. **DO NOT** cover the broiler insert with aluminum foil. The exposed fat could ignite.

2. Arrange oven rack and place the pan on the oven rack. Be sure to center the broiler pan directly under the broil burner. Open the oven door to the broil stop position.
3. Press **Broil**. “**BROIL**” will flash and “—°” appear in the display.
4. Press 5 5 0 . “**BROIL**” will flash and “**550°**” appear in the display.
5. Press **Start**. The oven will begin to broil. “**BROIL**” and “**550°**” appear in the display.
6. Broil on one side until food is browned; turn and cook on the second side. Season and serve.

**NOTE:** Always pull the rack out to the stop position before turning or removing food.

7. The “**BROIL**” light in the display will stay.
8. To cancel broiling or when broiling is complete press **Clear Off**.

#### Convection bake:

##### To set the convection bake feature:

(example 350° F)

1. Arrange oven racks and place food in oven.
2. Press **Conv Bake**. “**CONV BAKE**” icon will flash and “—°” will show in the display.
3. Press 3 5 0 . “**CONV BAKE**” icon will flash and “**350°**” will show in the display.
4. Press **Start**. The “**CONV BAKE**” icon will remain on. Also the “**350°**” oven temperature and the oven icon will show in the display.  
**NOTE:** The convection fan will come on a short time after the oven has been set for convection bake. The oven icon display will begin rotating indicating that the convection fan is operating.
5. Press **Clear Off** to stop baking or to cancel bake at any time.

##### Setting food categories feature:

The **Meats**, **Cakes**, and **Breads** pads in the Food categories have been designed to give optimum performance for the foods selected in each category.

The **Meats** pad combines a cook cycle with the convection fan and element to roast meats and poultry. Pre-

heating is not necessary for meats and poultry. Heated air circulates around the food from all sides, sealing in juices and flavors. Foods are crispy brown on the outside while staying moist on the inside.

The **Cakes** pad provides a preheat with a gentle cycling of heat, giving cakes more volume and allowing delicate foods to cook more evenly. Cooktimes may need to be extended when baking 4 cake layers at one time.

The **Breads** pad adds a preheat feature to the bake cycle to thoroughly heat the oven from top to bottom to give more evenly browned food.

##### To set the food categories feature:

(example cooking meats)

1. Arrange interior oven racks and place food in oven.
2. Press **Meats**. “**MEATS**” will flash and “—°” will be displayed.
3. Press 3 5 0 . “**MEATS**” will flash and “**350°**” will appear in the display.
4. Press **Start**. “**MEATS**” and “**350°**” will appear in the display and the convection fan icon will come on.

Press **Clear Off** to stop cooking meats, cakes, or breads, or to cancel at any time.

##### Self-clean cycle:

When planning to use the oven directly after a self-clean cycle remember to allow time for the oven to cool down and the oven door to unlock. This normally takes about one hour. Therefore, a 3 hour self-clean cycle will actually take about 4 hours to complete.

It is recommended to use a 2 hour self-clean cycle for **light soils**, a 3 hour cycle for **average soils**, and a 4 hour cycle for **heavy soils** (to assure satisfactory results).

**CAUTION: During the self-cleaning cycle, the outside of the range can become very hot to the touch. DO NOT leave small children unattended near the appliance; they may be burned if they touch the hot oven door surfaces.**

**CAUTION: DO NOT force the oven door open. This can damage the automatic door locking system. Use care when opening the oven door after the self-cleaning cycle. Stand to the side of the oven when opening the door to allow hot air or steam to escape. The oven may still be very hot.**

**To set the controls for the self-cleaning cycle to start immediately and shut off automatically:**

1. Be sure the clock shows the correct time of day and the oven door is closed.
2. Press **Clean**. “**CLEAN**” will flash and “**3:00**” will show in the display. If a 2 or 4 hour clean is desired use the number pads to enter the time. Set the cleaning time based on the amount of soil you have—light, average or heavy.
3. Press **Start**. The “**DOOR LOCKED**” icon will flash; “**CLEAN**” icon and the letters “**CLN**” will remain on in the display.
4. As soon as the controls are set, the motor driven oven door lock will begin to close automatically and once the door has been locked the “**DOOR LOCKED**” indicator light will quit flashing and remain on . Also the oven icon will show in the display.  
**NOTE:** It takes about 15 seconds for the oven door lock to close.

**When the self-clean cycle is completed:**

1. Only the time of day and the “**DOOR LOCKED**” icon will remain in the display.
2. Once the oven has cooled down for approximately 1 HOUR, and the word “**DOOR LOCKED**” shown in the display has gone out, the oven door can then be carefully opened.

**Stopping or interrupting a self-cleaning cycle:**

If it becomes necessary to stop or interrupt a self-cleaning cycle due to excessive smoke or fire in the oven:

1. Press **Clear Off**.
2. Once the oven has cooled down for approximately 1 HOUR and the “**DOOR LOCKED**” icon is no longer displayed, then the oven door may be carefully opened.

**How the ES 450 works:**

**CAUTION: NEVER ATTEMPT TO REMOVE EITHER THE BAKE OR BROIL ELEMENT WITHOUT DISCONNECTING ELECTRICAL POWER FROM THE RANGE. ELECTRICAL POWER IS CONNECTED TO THE ELEMENTS WHENEVER ELECTRICAL POWER IS CONNECTED TO THE RANGE.**

The ES 450 electronic oven control system is made up

of three parts that control the bake and broil elements, the speed bake fan in the oven, and the locking of the door in clean.

1. Electronic oven control.
2. Oven temperature sensor.
3. Oven door lock mechanism.

**Preheat:**

When the preheat pad is touched and a temperature is entered with the number pads, the bake relay on the board closes, and connects one side of the line to the bake element. “**PRE**” and “**BAKE**” appear in the display. After the first cycle “**PRE**” disappears and the oven operates as in normal bake.

**Bake:**

When the bake pad is touched, and a temperature is entered with the number pads, the bake relay on the board closes, and connects one side of the line to the bake element. “**BAKE**” appears in the display. In the tip of the oven sensor is a positive thermistor that increases in resistance as the oven temperature increases. The EOC microprocessor reads the resistance of the oven sensor, and compares it with the programmed temperature set into the control. When the resistance of the oven sensor indicates temperature in the oven is about 10 degrees above the programmed temperature, the microprocessor opens the relay, which removes power from one side of the element. When power is removed from the element the oven temperature begins to lower. As the oven temperature lowers the resistance of the oven sensor decreases. When the oven drops to about 10 degrees below the programmed temperature, the resistance of the sensor tells the microprocessor to close the relay contacts, and once again provide power to the element. After the first cycle and whenever the oven calls for heat, the EOC cycles the broil element on for seven seconds and then the bake element on for fifty three seconds out of every minute. This provides top heat during the bake cycle. The two elements are never on at the same time.

**NOTE: Oven controls may have a temperature swing of more or less than 20 degrees. The important thing is the average temperature in the oven. The average temperature in the center of the oven should be within 10 degrees of the programmed temperature.**

**Time bake:**

The time bake function allows the oven to be programmed to stop bake at a set time, or to delay the start and stop

baking at a set time. The stop time cannot be set for more than 11 hours and 59 minutes ahead of the time of day.

### **Convection bake:**

When the convection bake pad is touched and a temperature is set, two things happen that do not happen in normal bake. The EOC automatically raises the oven temperature 15° F above the temperature that was manually set in the control. If the oven door is closed, the convection relay on the EOC closes, providing line to neutral voltage to the convection fan motor and the convection assist element. This relay remains closed until the program is canceled or is interrupted by the opening of the oven door. If interrupted by the opening of the oven door, the relay will automatically close when the door is closed.

### **Fixed Settings:**

#### **Meats:**

When the meats pad is touched the oven operates with the convection fan and assist element at the set temperature.

#### **Cakes:**

When the cakes pad is touched the oven operates at a lower than set temperature with less temperature differential.

#### **Breads:**

When the breads pad is touched the oven operates at a higher than set temperature with more temperature differential. In addition, the broil element is on a higher percentage of the time.

### **Broil:**

When the broil pad is touched, and a temperature is entered with the numbers between 400° F and 550° F. (usually 550° F) the broil relay on the board closes, and connects one side of the line to the broil element. In the tip of the oven sensor is a positive thermistor that increases in resistance as the oven temperature increases. The EOC microprocessor reads the resistance of the oven sensor, and compares it with the programmed temperature set into the control. Usually you do not want the broil element to cycle so the oven door is opened to the broil stop position. If the door is not opened the broil element will cycle when the set temperature is reached.

### **Clean:**

With the oven door closed, contacts COM to NO of the oven door switch close. Then when the clean pad is touched and a clean time is set the door lock relay on the electronic oven control closes providing line to neutral voltage (120 VAC) to the lock motor. The lock motor starts to rotate, closing the contacts of the door lock switch. When the motor rotates one half turn the contacts of the door lock switch reopen sending a signal to the EOC that the door is locked, and to open the contacts of the lock relay. The lock indicator light then glows steady and the EOC closes the bake relay providing power to the bake element. The clean temperature is preset into the EOC at around 860° F. It takes about 45 minutes for the oven to reach 860° F. When the temperature is reached the control cycles the bake element off and on to maintain the temperature until the clean time is completed. When the clean time is completed the EOC removes power from the bake element and the oven cools down. When the temperature in the oven goes below 500° F the control closes the contacts of the lock relay. The lock motor then turns 180 degrees closing and reopening the contacts of the lock switch and unlocking the door. The open contacts of the lock switch tells the control that the door is unlocked and to open the contacts of the lock relay and turn the lock indicator light off.

### **Calibration:**

To check oven calibration:

1. Place a thermometer or thermocouple in the center of the oven.
2. Program the oven for bake and the temperature to 350° F. Allow the oven to cycle three times.
3. Average the highest and lowest reading. The average should be within 10° F of 350° F.

### **To change the calibration:**

To adjust the oven temperature higher:

1. Press the **Bake pad** for 6 seconds. "0" will appear in the display.

**NOTE: If any numbers other than "0" appear in the display, the control has been previously calibrated in the field.**

2. To increase the temperature, use the number pads to enter the desired change. The temperature may be increased up to 35° F.
3. Press **Start** to accept the temperature change and

the display will return to the time of day. Press **Clear Off** to reject the change if necessary.

To adjust the oven temperature lower:

1. Press the **Bake pad** for 6 seconds. "0" will appear in the display.
2. To decrease the temperature, use the number pads to enter the desired change and then press **Clean**. The temperature may be decreased up to 35° F. (NOTE: Pressing **CLEAN** allows the entry of negative degree change.)
3. Press **Start** to accept the temperature change and the display will return to the time of day. Press **Clear Off** to reject the change if necessary.

### Troubleshooting:

The ES 450 has some self diagnostics built into the microprocessor to help in troubleshooting the system. When a failure occurs one of three codes will appear in the display window: F1, F3 or F9.

#### F1 code:

An F1 indicates a malfunction in the EOC itself, and the control should be replaced.

#### F3 code:

An F3 indicates a defective sensor, electronic oven control or the wiring in between. To determine which part is defective:

1. Disconnect the Fifteen pin plug from the back of the EOC that connects the sensor to the oven control.
2. With an Ohmmeter measure the resistance between pins 14 and 15 in the plug (not on the EOC). If the meter reads around the value of the oven temperature sensor resistance chart shown below, the oven control is defective. If the meter reads less than 800 Ohms, or more than 3000 Ohms, go to step 3.

RTD SCALE	
Temperature (°F)	Resistance (ohms)
32 ± 1.9	1000 ± 4.0
75 ± 2.5	1091 ± 5.3
250 ± 4.4	1453 ± 8.9
350 ± 5.4	1654 ± 10.8
450 ± 6.9	1852 ± 13.5
550 ± 8.2	2047 ± 15.8
650 ± 9.6	2237 ± 18.5
900 ± 13.6	2697 ± 24.4

3. Disconnect the harness from the oven sensor and measure the resistance of the oven sensor. If the meter reads less than 800 Ohms, or more than 3000 Ohms, the oven sensor is defective. If the reading is correct with the chart the harness is defective.

#### F9 code:

An F9 code indicates the EOC has detected a problem with the motor door latch assembly. Check the contacts of the lock switch, wiring to the lock motor assembly, and the lock motor.

#### Control will not program:

If the control will not program, check for an open sensor circuit. If the sensor circuit is good, replace the EOC.

#### Time bake does not operate:

If the time bake feature does not operate, check to be sure it is being programmed correctly. If it is being programmed correctly, then replace the control.

#### Convection bake:

#### Neither the fan motor or the assist element operates:

1. Remove power from range. Go to the back of the electronic oven control and disconnect the 15 pin plug. With the oven door closed, measure the resistance between pins 10 and 12 of the 15 pin plug (in the plug). If the meter reads open, check the door switch and the wiring from the electronic oven control to the door switch. If the meter reads zero go to step 2.
2. Measure the resistance between pins 5 and 7. If the meter reads around 10 Ohms the control is defective. If the meter reads infinity either the wiring to the fan motor and element is open or both the fan motor and the element are defective.

#### Fan motor does not operate:

1. If the assist element is heating then the fan motor itself or the wiring to the fan motor is defective. Also check for a blocked fan blade.

#### Assist element does not operate:

1. If the convection fan is operating then the element itself or the wiring to the element is defective.

#### Control does not operate in preheat:

1. If the oven operates in bake but not preheat, the EOC is defective.



**Blank display:**

1. With the range connected to electrical power, go to the back of the control and measure the voltage drop between terminal L1 and neutral. If the meter reads line to neutral voltage (120 VAC), the control is defective. If the meter reads zero the wiring in the range is defective.

**Bake element does not heat:**

1. With the range connected to electrical power, go to the back of the oven control and measure the voltage drop between terminals BA and neutral with the control not programmed (clock operating only). If the meter reads line to neutral (120VAC) the control is defective. If the meter reads zero, the bake element or the wiring to the bake element is defective. Go to step 2.
2. Remove the back from the range to gain access to the terminals of the bake element. Program the oven control for bake and measure the voltage drop across the terminals of the bake element. If the meter reads line to line voltage (240 VAC) the element is defective. If the meter reads zero the wiring to the element is open.

**Broil element does not heat:**

1. With the range connected to electrical power, go to the back of the oven control and measure the voltage drop between terminals BR and neutral with the control not programmed (clock operating only). If the meter reads line to neutral (120VAC) the control is defective. If the meter reads zero the broil element or the wiring to the broil element is defective. Go to step 2.
2. Remove the back from the range to gain access to the terminals of the broil element. Program the oven control for broil and measure the voltage drop across the terminals of the broil element. If the meter reads line to line voltage (240 VAC) the element is defective. If the meter reads zero the wiring to the element is open.

**Oven door does not lock when the oven is programmed for clean:**

1. Remove power from the range, go the back of the control and disconnect the 15 pin plug. Measure the resistance between pins 5 and 6 of the 15 pin plug (in the plug). If the meter reads infinity, the lock motor or the wiring to the lock motor is defective. If the meter reads around 1500 ohms go to step 2.

2. Measure the resistance between pins 9 and 11 of the 15 pin plug with the oven door closed. If the meter reads infinity, the door switch or the wiring to the door light switch is defective. If the meter reads zero go to step 3.
3. Measure the resistance between pins 9 and 10 of the 15 pin plug. If the meter reads infinity the lock switch or the wiring to the lock switch is defective. If the meter reads zero the control is defective.

**Lock motor runs continuously:**

1. With the door in the unlock position, remove power from the range. Go to the back of the control and disconnect the 15 pin plug from the control. With an Ohmmeter measure the resistance between pins 9 and 10 of the 15 pin plug (in the plug). If the meter reads zero the lock switch or the wiring to the lock switch is defective. If the meter reads infinity go to step 2.
2. Depress the arm of the lock switch, and measure the resistance between pins 9 and 10 of the 15 pin plug. If the meter reads infinity the lock switch or the wiring to the lock switch is defective. If the meter reads zero the control is defective.  
NOTE: Always check the cam arm relationship.

**Oven door locks but the oven does not heat:**

1. If the oven operates in normal bake replace the control.

**Door latch is partly closed with door open:**

1. Program the oven for self-clean, and hold in on the door switch for 30 seconds. Touch cancel and hold door switch in for 30 seconds. The lock motor should lock and unlock the door.

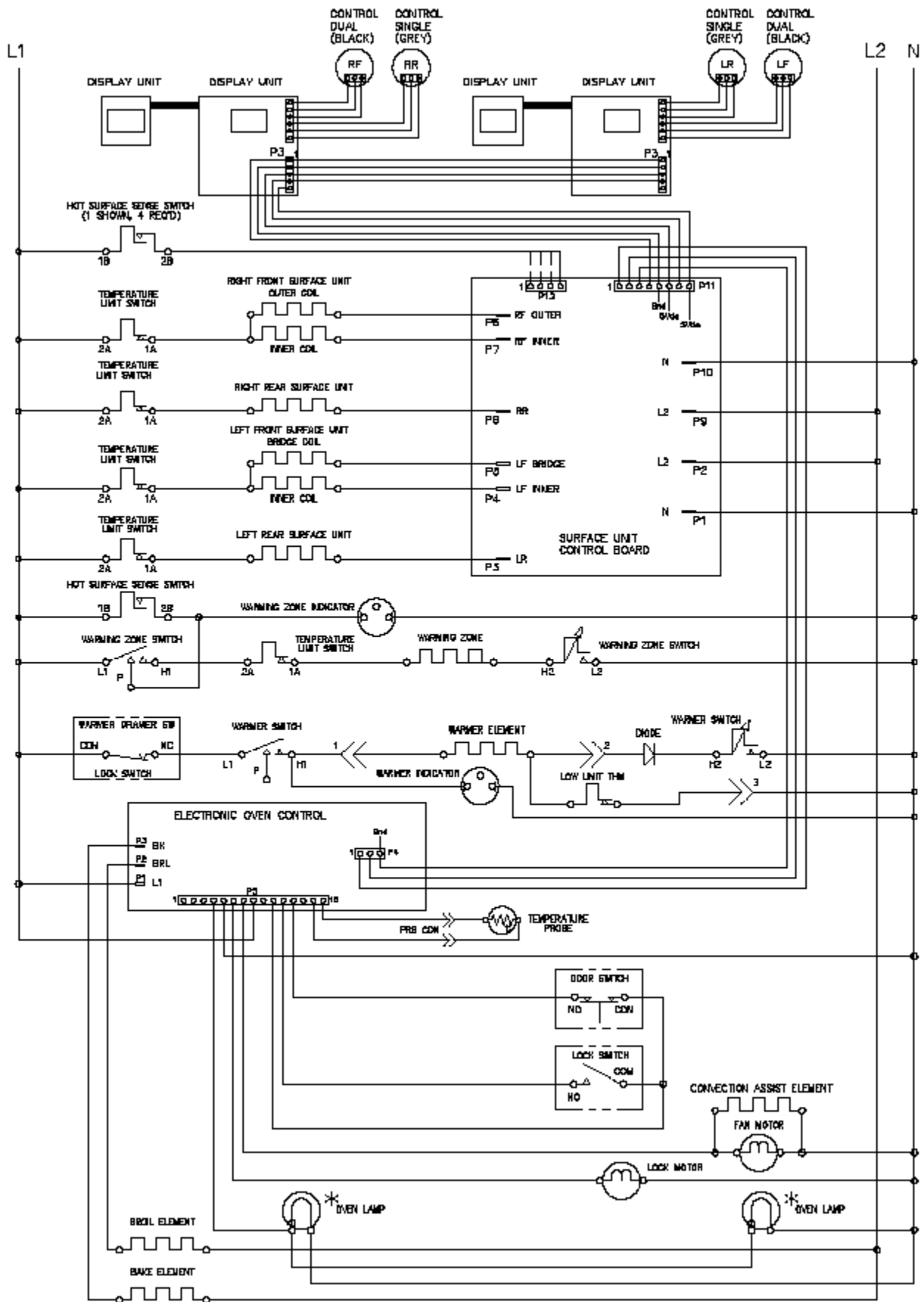

SAMPLE SCHEMATIC FOR THE ES 450 CONTROL SYSTEM

## Warmer drawer:

Warmer drawers are used to hold food at serving temperature, usually between 160° F to 190° F.

### To set the warmer drawer thermostat control:

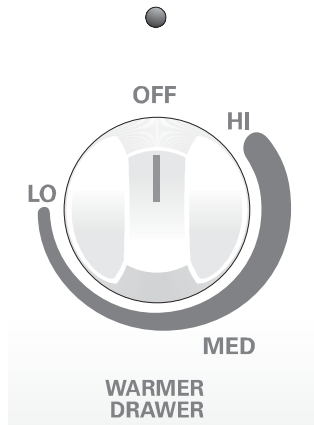

The thermostat control is used to select the temperature of the warmer drawer. It is located on the control panel. To set the thermostat, push in and turn the knob to the desired setting. The temperatures are approximate, and are designated by HI, MED and LO.

1. Turn the knob to select the desired temperature setting.
2. For best results, preheat the drawer before adding food. An empty drawer will preheat in approximately 15 minutes.
3. Turn the thermostat control to **OFF** after use.

### How the warmer drawer circuit works:

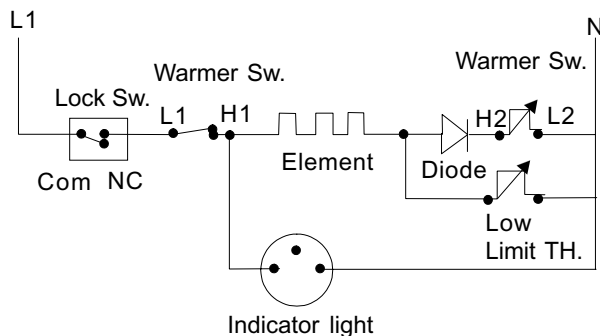

The warmer drawer circuit operates in two cycles: Preheat and Hold.

Preheat or the first cycle is controlled by the low limit thermostat which is set to open at about 200° F and

reclose at about 130° F. The low limit thermostat is connected electrically in parallel with the diode and cycling contacts of the warmer switch. No matter where the warmer knob is set during the first cycle, the temperature will always go to about 200° F. After the first cycle and during the holding cycles, the warmer drawer temperature is controlled by the cycling contact of the warmer drawer switch. The diode is placed in the circuit to lower the power to the element by about 30% during the holding cycles. This allows the warmer drawer to operate at a lower temperature during the hold cycle.

### Troubleshooting:

There are five ways a warmer drawer control system can fail with a standard infinite switch:

1. The element does not heat.
2. The element heats during preheat, then stay off until the temperature drops to about 130° F.
3. The switch does not cycle the element off in the hold.
4. Slow preheat.
5. The element operates correctly, but the indicator light does not glow.

### If the element does not heat:

1. Check to see if the indicator light is glowing. If the indicator is not glowing remove the back panel of the backguard and measure the voltage drop between terminal L1 on the switch to neutral. If the meter reads zero, the lock switch or the wiring to the lock switch is open. If the meter reads line to neutral voltage (120VAC) go to step 2.
2. Turn the switch on and measure the voltage drop between terminal H1 on the switch and neutral. If the meter read zero the switch is defective. If the meter reads line to neutral voltage, the indicator light or the wiring to the indicator light is defective. Correct the indicator light problem and go to step 3.
3. Remove the warmer drawer and measure the voltage drop across the terminals of the element. If the meter reads line to neutral voltage the element is defective. If the meter reads zero go to step 4.
4. Measure the voltage drop from each terminal of the element to neutral. If the meter reads zero on both terminals the wire from terminal H1 on the switch to the element is open. If the meter reads line to neutral voltage, check the wiring to the low limit thermostat, the diode, and the cycling portion of the warmer switch. If the wiring is good, the low limit thermostat is defective, and either the diode or the switch is also defective.

**If the element heats during preheat, then stay off until the temperature drops to about 130° F:**

1. Check the diode and the cycling portion of the warmer switch.

**If the element does not cycle off:**

1. Remove one wire from the low limit thermostat and set the warmer switch to low. If the element cycles after the drawer has warmed up the low limit is defective, if it does not the warmer switch is defective. It is also possible for a wire on the neutral side of the element to be shorted to chassis.

**If the warmer drawer is slow preheating:**

1. Normal preheat time is around 15 minutes with the drawer empty. Check the low limit thermostat. If the contacts are open, replace the thermostat.

**If the warmer drawer heats, but the indicator light does not glow:**

1. Check the indicator light and the wiring to the indicator light. (Note: Indicator light does not cycle with the element.)

## SECTION D - DISASSEMBLY AND REPLACEMENT OF PARTS

**NOTE:** To reinstall parts, reverse all procedures

### Backguard

To remove the backguard back panel:

1. Disconnect power from range.
2. Remove six screws and lift the panel off.

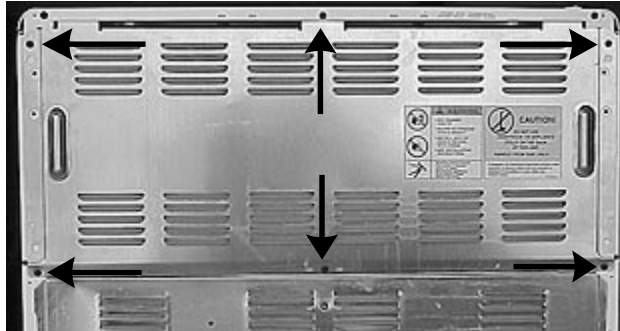

**Six backguard back panel screws**

**NOTE:** Screws may be removed using either a 1/4" nut driver or an S1 square drive.



**Screw bits**

To remove the infinite switches:

Infinite switches are used for the surface elements, warm and serve zone, and the warming drawer (if equipped).

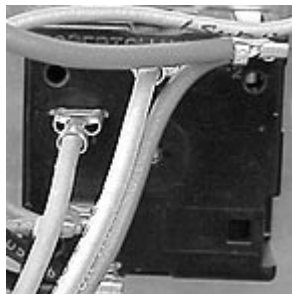

**Backview of infinite switch**

1. Disconnect power from the range.
2. Remove the back panel from the backguard.
3. Mark and disconnect the wires from the infinite switch.
4. Remove the knob by pulling straight off.

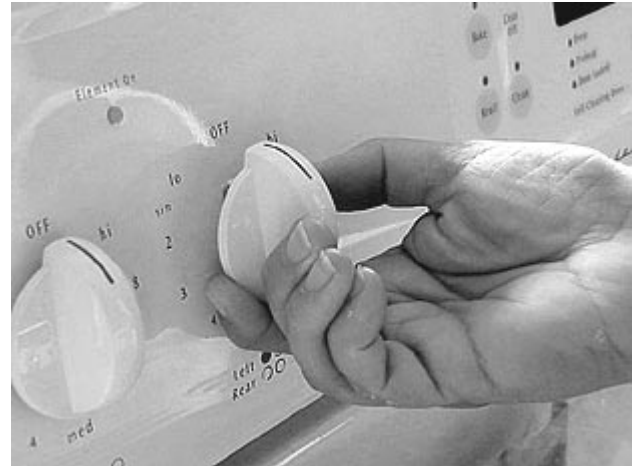

**Pull knob straight off**

5. Remove the two phillips-head screws holding the switch to the control panel.

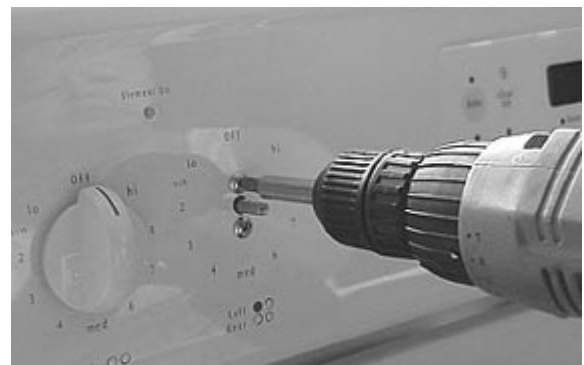

**Removing two screws**

6. Pull the switch from the back of the range.

### Electronic Surface Controls

To remove the potentiometer:

1. Disconnect power from the range.
2. Remove the back panel from the backguard.
3. Unplug the three pin plug from the potentiometer.

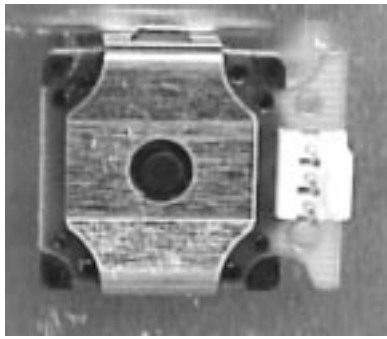

**Backview of potentiometer**

4. Remove the knob by pulling straight off.
5. With a 1/2" wrench remove the holding nut by turning it counterclockwise, and remove the potentiometer from the rear.

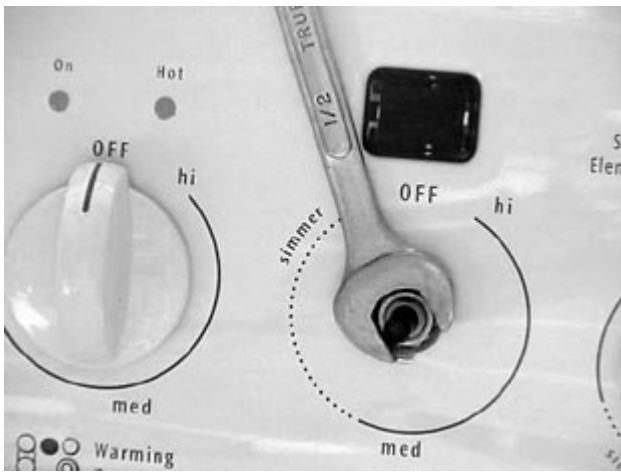

**Removing 1/2" potentiometer nut**

**User Interface Board**

The user interface board is made up of two boards. The replacement board will come as one part and it will be necessary to break the two boards apart along the perforated line. The board snaps into the display windows and are spaced from the control panel by four rubber pads around each display. These pads are stuck to the display and can be removed and reattached.

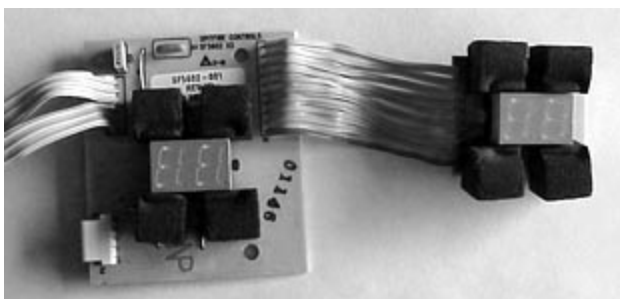

**User interface board showing rubber pads**

**To remove the user interface board:**

1. Disconnect power from the range.
2. Remove the back panel from the backguard.
3. Disconnect the harness from the board and unplug the ribbon from the potentiometers at the potentiometer.
4. Squeeze the two plastic prongs holding the board to the display window together and pull back on the board.

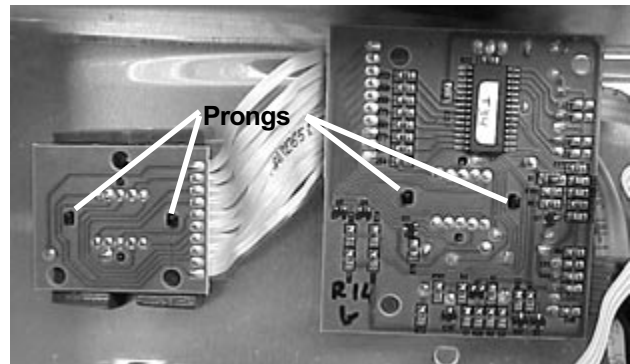

**Backview of user interface board**

**To remove the display window:**

1. Disconnect power from the range.
2. Remove the back panel from the backguard.
3. Remove the user interface board.
4. Squeeze the sides of the display and push it out the front.



**Display window**

**To remove the top element's indicator light:**

1. Disconnect power from the range.
2. Remove the back panel from the backguard.
3. Disconnect the wires from the light.
4. Push in and down.

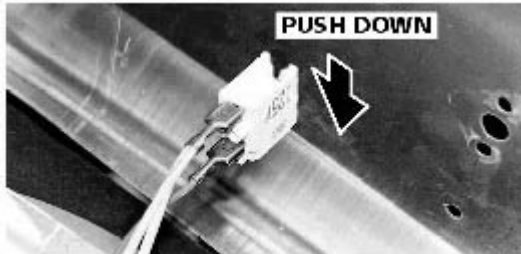

**Indicator light**

**To remove the electronic oven control:**

1. Disconnect power from the range.
2. Remove the back panel from the backguard.
3. Disconnect the wires and harness from the control board.
4. Remove the four screws. (One from each corner)



**Backview of electronic oven control**

**To remove the oven light switch:**

1. Disconnect power from the range and remove the back panel from the backguard.
2. Disconnect the wires from the switch, squeeze the sides, and push up.



**Oven light switch**

**To remove the control panel:**

1. Disconnect power from the range.
2. Remove the back panel from the backguard.
3. Remove the knobs.
4. Disconnect the infinite switches or potentiometer and user interface boards from the control panel.
5. Disconnect the electronic oven control.
6. Disconnect the indicator light and the oven light switch.
7. Remove two square drive screws from the back top corners.



**Square drive corner screws**

8. Remove two phillips screws, one in each corner of lower front. Roll the bottom of the control panel out and lift up.

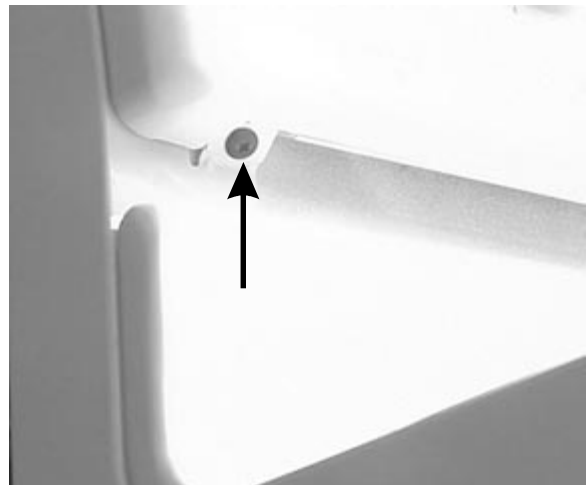

**Front corner screw**

**To remove the end caps:**

1. Disconnect power from the range.
2. Remove the back panel from the backguard.
3. Remove the four screws holding the control panel to the end caps and lift it up.

Ranges with coil top elements:

4. Raise the front of the main top and disengage the lift and lock rods.



**Coil element top lift and lock rod**

Smooth top ranges:

5. Open the oven door and remove the two phillips screws holding the main top to the front frame.

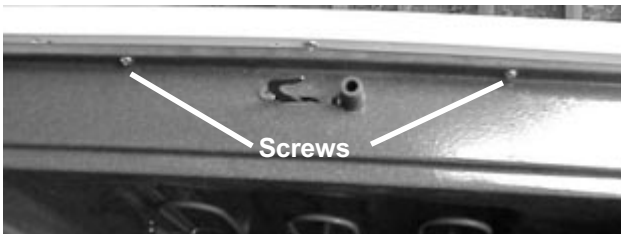

**Smoothtop main top screws**

6. Remove two square drive screws from each main top hinge and slide the top forward about 2 inches.



**Main top hinge screws**

7. Remove the two screws holding the end cap to the splash guard and the side panel, and lift the end cap up.

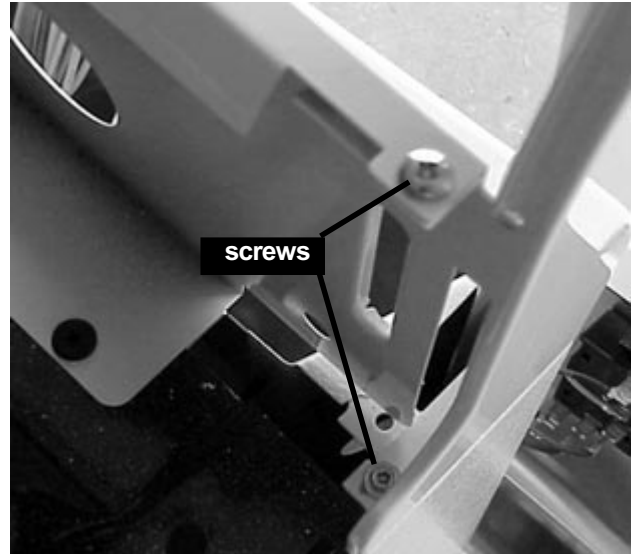

**End cap screws**

**To remove the splasher panel:**

1. Disconnect power from the range.
2. Remove the back panel from the backguard.
3. Remove the four screws holding the control panel to the end caps and lift it up.

Ranges with coil top elements:

4. Remove the top elements, and unfasten the terminal blocks from the main top by removing one screw from each terminal block.

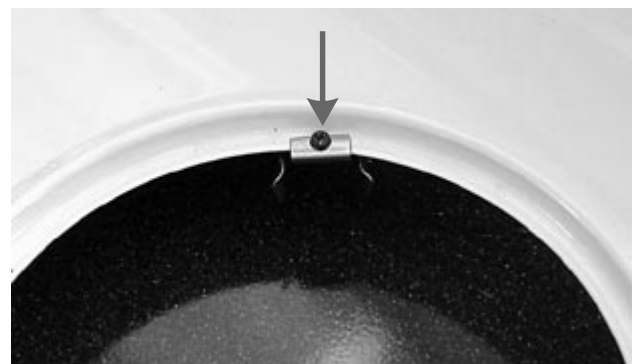

**Terminal block screw**

5. Raise the front of the main top and disengage the lift and lock rods.
6. Remove the four hinge screws.



7. Disconnect the wire tie from the rear of the main top by squeezing the tabs of the rivet. Go to step 10.



**Wire tie**

Smooth top ranges:

8. Open the oven door and remove the two phillips screws holding the main top to the front frame and raise the main top.
9. Tag and disconnect all wires that come from the backguard to the elements.

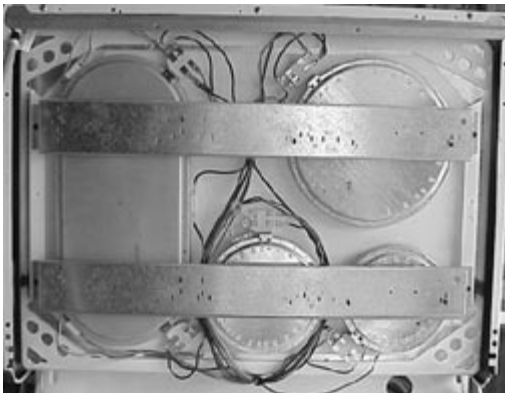

**Smoothtop element wiring**

10. Pull the wires and terminal blocks out the back of the range and go to step 11.



**Hole in splasher panel**

11. Remove the three screws holding the oven vent cover and remove the oven vent cover.



**Vent cover**

12. Remove the two screws holding the splasher panel to the burner pan.

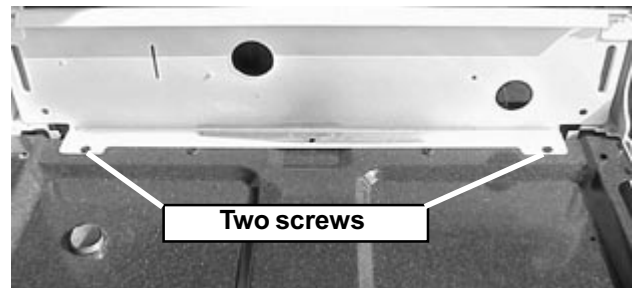

**Splasher panel screws**

**Main Top Area:**

**To remove the main top with coil elements:**

1. Disconnect power from the range.
2. Remove the back panel from the backguard.
3. Remove the top elements, and unfasten the terminal blocks from the main top by removing one screw from each terminal block.



**Terminal block screw**

4. Remove the four hinge screws, two on each side.

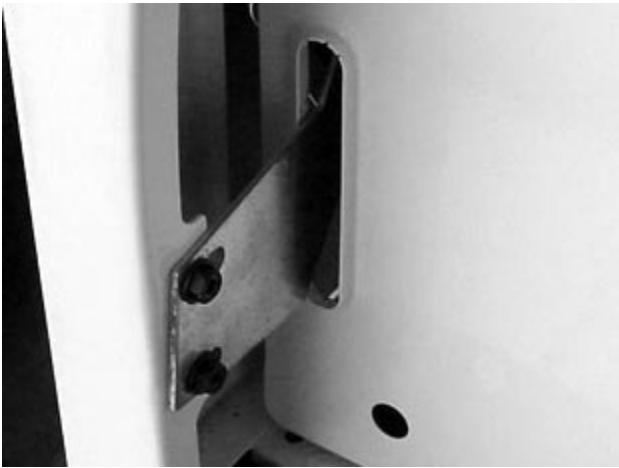

**Hinge screws**

- 5. Raise the front of the main top, disengage the lift and lock rods, and pull the main top forward.



**Lift and lock rod**

- 6. Disconnect the wire tie from the rear of the main top by squeezing the tabs of the rivet.



**Wire tie**

- 7. Pull the top forward and up.

**To remove the main top on smooth top ranges:**

- 1. Disconnect power from the range.
- 2. Remove the back panel from the backguard.
- 3. Open the oven door and remove the two phillips screws holding the main top to the front frame and raise the main top.
- 4. Remove the fill strip from the front edge of the main top by removing three screws.

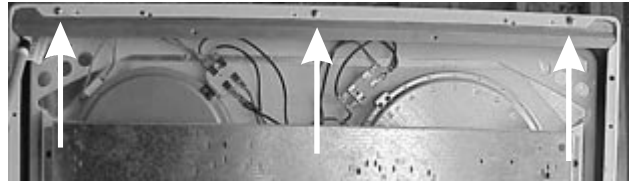

**Three filler screws**

- 5. Remove the screw from the ends of the element support bar and allow the element to drop down.

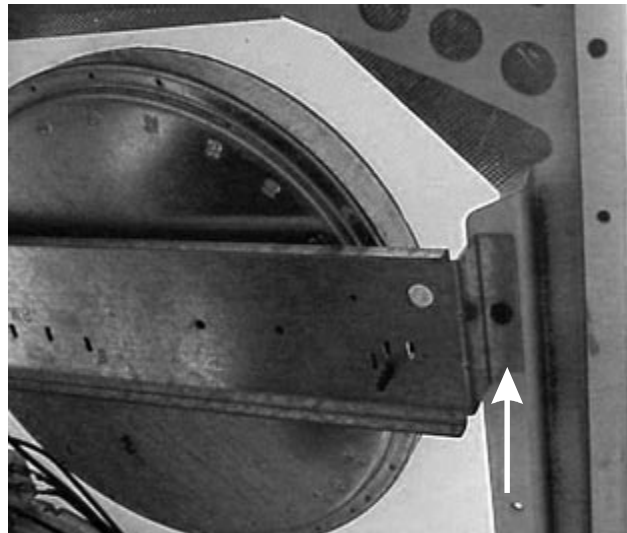

**Bar screw**

- 6. Remove the four hinge screws, lift up on the front of the main top and pull forward.



**Hinge screws**

**To remove the main top hinges:**

1. Disconnect power from the range.
2. Remove the back panel from the backguard.
3. Remove the four hinge screws. (Two on each side).

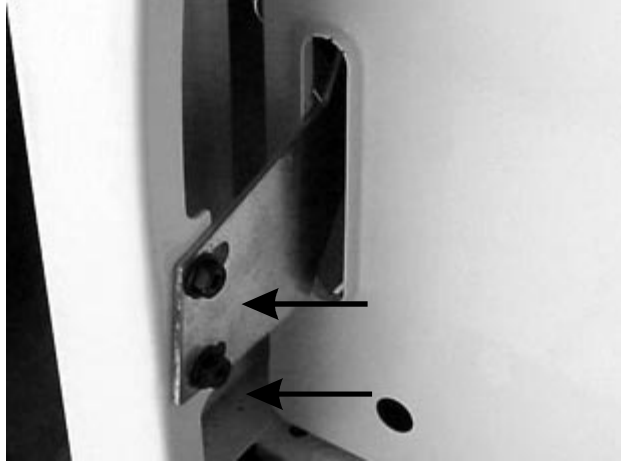

**Hinge screws**

**Smooth top ranges:**

4. Open the oven door and remove the two phillips screws holding the main top to the front frame and raise the main top. Go to step 6.

**Coil element ranges:**

5. Raise the front of the main top and disengage the lift and lock rods.
6. Pull the top forward until the hinges have cleared the backguard, then angle the top.
7. Remove the two screws that hold the hinge to the main top and slide it out the end.

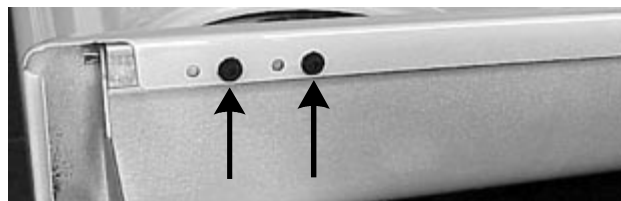

**Hinge screws**

**To remove the top elements:**

**Coil elements:**

1. Lift the side of the element that is away from the terminal block up about 1" and pull out.

**Smooth top elements:**

1. Disconnect power from the range.
2. Open the oven door and remove the two phillips screws holding the main top to the front frame and raise the main top.
3. Tag and disconnect wires from the element to be removed.
4. Remove the two screws, one on each end, of the element support bar.
5. The element is held to the support bar by 2 spring load clips. With a pair of needlenose pliers squeeze the tab on the spring mounting clip and push the element away from the bar.

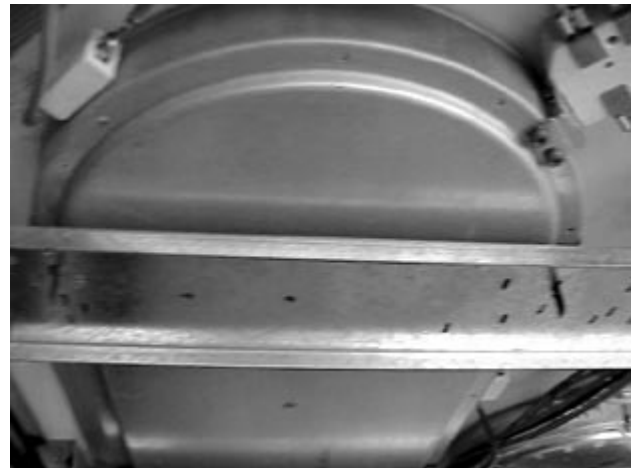

**Mounting clips**

6. The clips are held to the element by screws. When replacing the element be sure to note the hole number that the clip is attach to the old element.

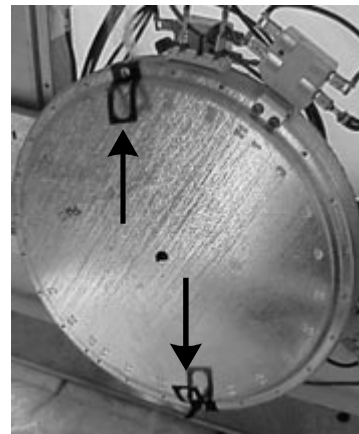

**Element and clips**

**To remove and replace terminal blocks for coil elements:**

1. Disconnect power from the range.
2. Remove element and drip pan.
3. Unfasten the terminal block from the main top by removing one screw.



**Terminal block screw**

4. The replacement terminal block will come as a kit. The terminal block in the kit will have wires about 4" long and wire nuts.
5. Pull the terminal block into the element opening and cut and splice the wires.

**To remove the lift and lock rods:**

1. Lift the top and disengage the lift and lock rod from the side panel.
2. Remove the one screw holding the lift and lock rod to the main top.



**Lift and lock rod screw**

**To remove burner pan (coil element ranges only):**

1. Disconnect power from the range.
2. Remove main top. (See main top removal)
3. Remove the oven vent by removing two screws inside the oven holding the oven vent to the oven liner.

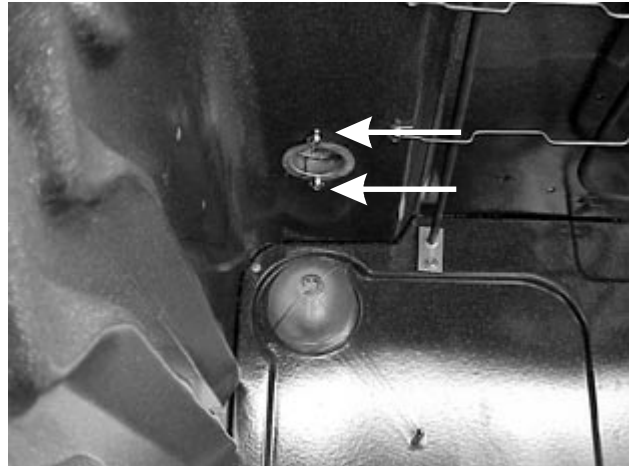

**Two oven vent screws**

4. Remove the ten screws holding the burner pan to the side panels and the back panel, and slide the burner pan forward.

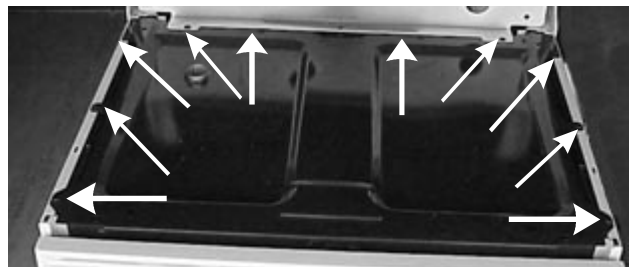

**10 burner pan screws**

**Oven Door**

**To remove oven door seal:**

1. The oven door seal is snapped to the inner door with wire clips. To remove the seal pull up on the seal.

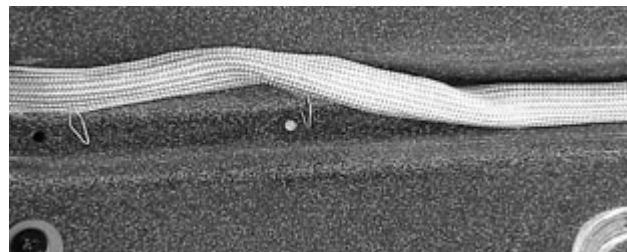

**Door seal and clips**

### To remove oven door:

1. The oven door is held to the oven door hinges by two screws. (One in each hinge.)
2. To remove the oven door remove the two screws.



**Two screws**

3. Close the door to the broil stop position and lift up.

### Door hinge adjustment:

1. Each side of the door may be raised by adjusting the screw in the end of each hinge.



**Adjustment screw**

### Removal of the hinge opening cover:

1. The top of the hinge opening cover is tabbed and is slid behind the front frame. The bottom of the hinge opening is held to the front frame by the top hinge screw.



**Hinge cover**

### Door hinge removal:

**NOTE: Left and right door hinges are separate parts. They are not identical.**

1. Remove the two screws holding the hinge to the front frame.

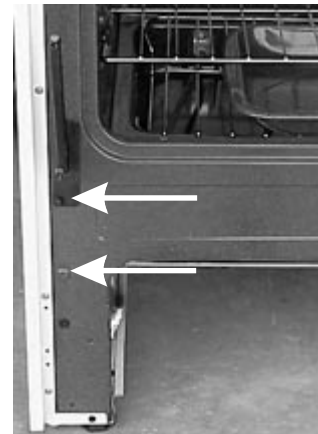

**Hinge screws**

2. Collapse the hinge, push down and tip the bottom of the hinge toward the back of the range.
3. When the top of the inner hinge goes below the opening in the front frame, pull the hinge out.

### Oven Door Disassembly

#### Removing the upper door trim:

1. Remove the oven door and lay it on a flat surface.
2. Remove the two screws holding the trim to the inner liner.
3. Slide the trim off the top of the door.

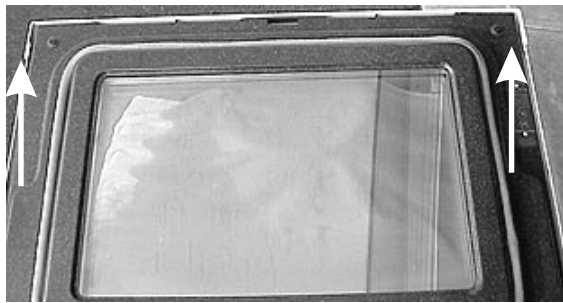

**Trim screws**

**Door handle:**

1. Remove upper door trim.
2. Remove the two screws holding the door handle to the upper door trim.



**Handle screws**

**Outer door glass and trim:**

1. Remove upper door trim.
2. Remove the four screws at the bottom holding trim to the inner door liner, and lift the glass and trim off.

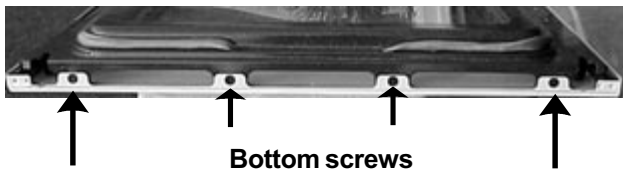

**Bottom screws**

**Center glass:**

1. Remove the outer door glass and trim.
2. Remove the eight screws, four from each, holding the top and bottom center glass trims.
3. Remove the trims and lift the glass off.

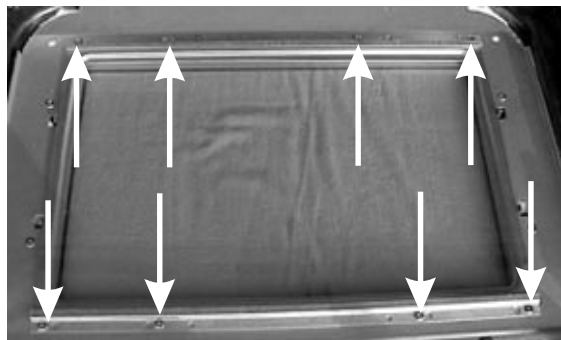

**Eight trim screws**

**Wool shield:**

1. Remove the center glass.
2. Remove the six screws, two at the bottom and two on each side, holding the wool shield to the inner liner and slide the wool shield up and off.

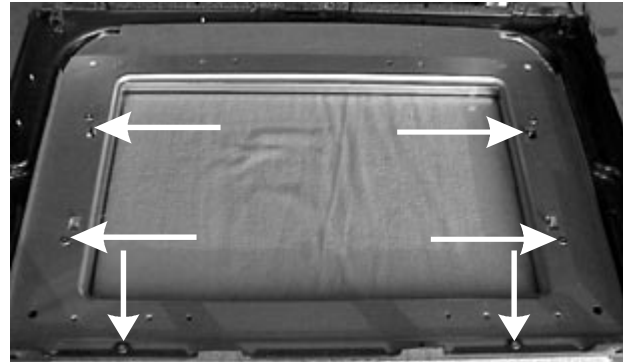

**Six wool shield screws**

**Glass package and inner door liner:**

1. Remove the wool shield. The glass package can now be lifted out.
2. With the glass package removed, the door seal, insulation and the inner door remain.



**Glass package and insulation**

**Components inside the oven**

**NOTE:** One side of both the bake and broil elements is connected to Line 2. Never try to remove either the bake or broil element without disconnecting power.

**Bake element:**

1. Disconnect power from the range.
2. Remove the two screws holding the bake element to the oven liner.

3. Pull the element into the oven and disconnect the wires.

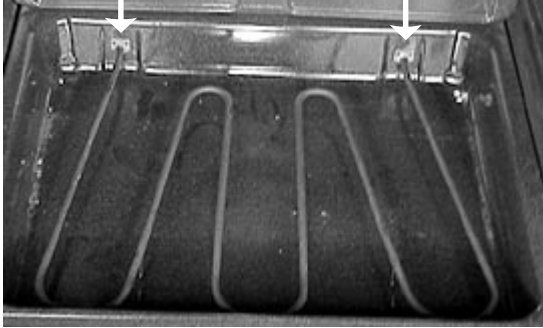

**Bake element screws**

**Broil element:**

1. Disconnect power from the range.
2. Remove the two screws holding the element to the oven liner.
3. Remove the two element hangers by removing the one screw from each and pull the element into the oven.
4. Disconnect the wires.

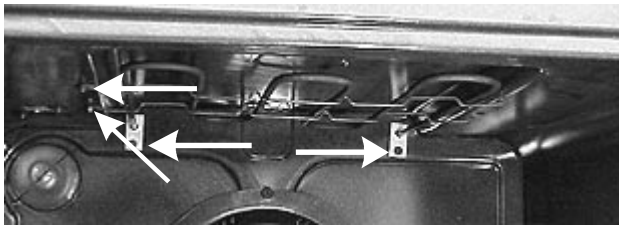

**Broil element and hanger screws**

**Fan blade (convection/speed bake models):**

1. Disconnect power from the range.
2. Remove the two screws holding the fan cover to the oven liner and remove the cover.

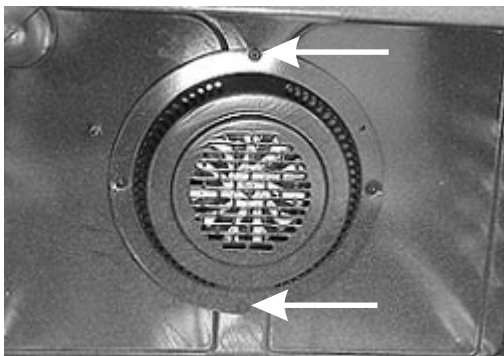

**Fan cover screws**

3. Hold the fan blade and remove the nut by turning clockwise with a 1/2" wrench.

4. With the nut remove pull the fan blade off the shaft.

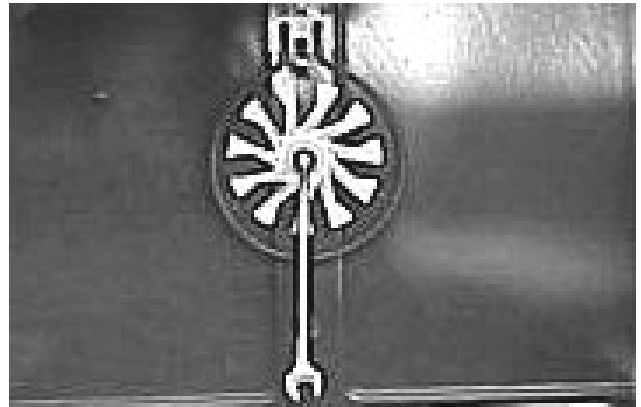

**1/2" wrench**

**Convection assist element removal:**

1. Disconnect power from the range.
2. Remove the fan cover.
3. Remove the two screws holding the element to the oven liner.
4. Pull the element into the oven and disconnect the wires.

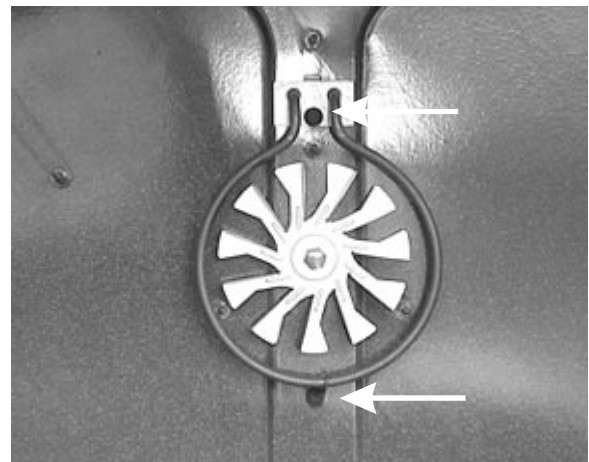

**Assist element screws**

**Oven vent (coil element models):**

1. Remove the two screws holding the vent to the oven liner and pull the vent into the oven.



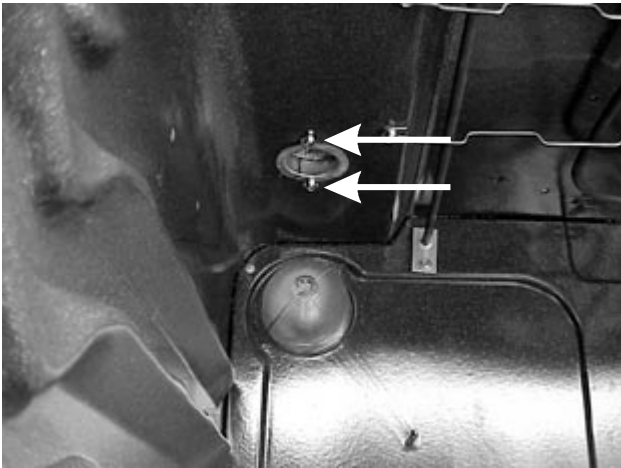

**Oven vent (coil element models)**

**Oven vent (smooth top models):**

1. Remove the backguard back panel and the range back.
2. Remove the vent cover by removing three screws.

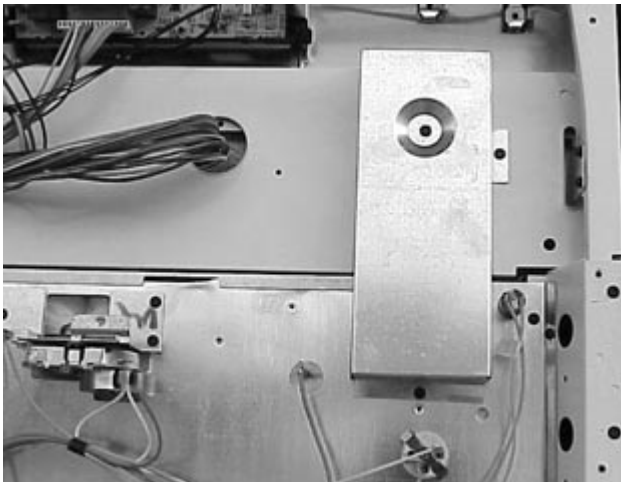

**Vent cover on smooth top models**

3. The oven vent is a two piece vent.

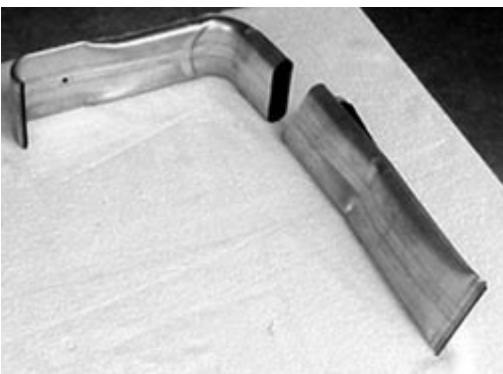

**Oven vent pieces**

4. To remove the back half of the vent pull straight back.

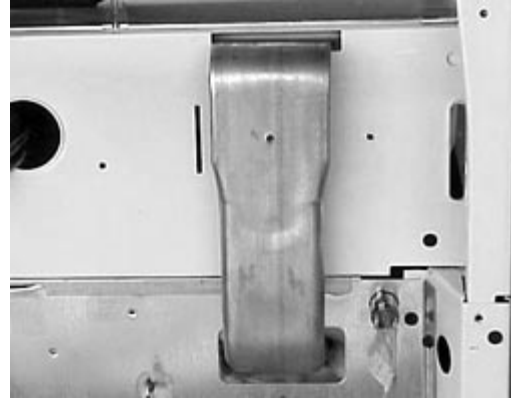

**Backview of oven vent**

5. To remove the complete vent. Remove the two screws inside the oven holding the vent to the oven liner and pull the vent out the back.

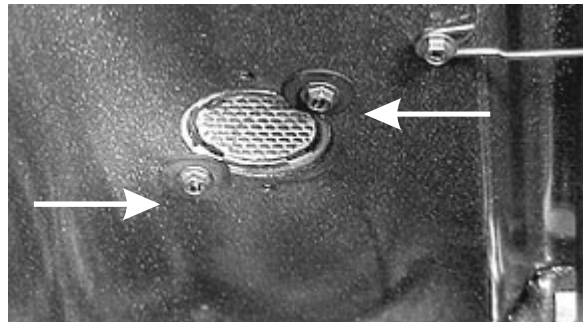

**Inside oven vent screws**

6. When installing the vent, slide the vent back in place and install the cover. Tighten the screw in the cover down, then loosen the screw in the center of the vent cover. This will help align the vent to the opening in the oven and make it easier to install the screws inside the oven to the vent.

**Removing the oven light cover (self-clean models):**

1. Unsnap the spring loaded wire and pull the cover off.



**Cover wire**



### Door latch removal (self clean):

1. Disconnect power from the range.
2. Models with coil top element remove the burner pan. (See burner pan removal.)
3. For smooth top models, open the oven door and remove the two phillips screws holding the main top to the front frame and raise the main top.
4. Remove the two screws and bumper holding the latch to the front frame. Push the latch back into the range and disconnect the latching rod.

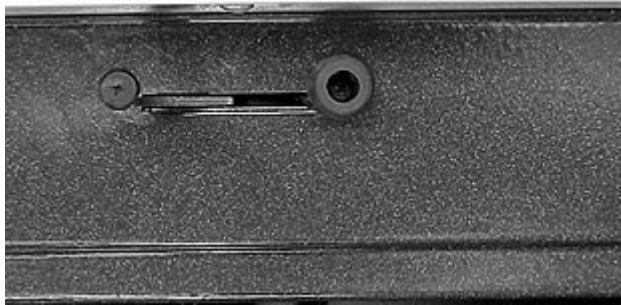

**Screws and bumper**

**NOTE:** The screw inside the bumper is a square drive.



**Latch rod**

### Door switch and rod removal (self-clean):

1. Disconnect power from the range.
2. Models with coil top element remove the burner pan. (See burner pan removal.)
3. For smooth top models open the oven door and remove the two phillips screws holding the main top to the front frame and raise the main top.
4. Remove the backpanel from the backguard and disconnect the wires from the door switch.
5. Squeeze the spring loaded tabs of the door switch

and push it into the range. Once the switch clears the back panel the switch can be unhooked from the rod, and the rod slid back into the range.



**Door switch**

### Components Mounted to the Back of the Range

#### Removing the back cover:

1. Disconnect power from the range.
2. Remove eight screws, three on each side (6) and two at the top center. Lift the back cover out of the two tabs holding the cover at the bottom.

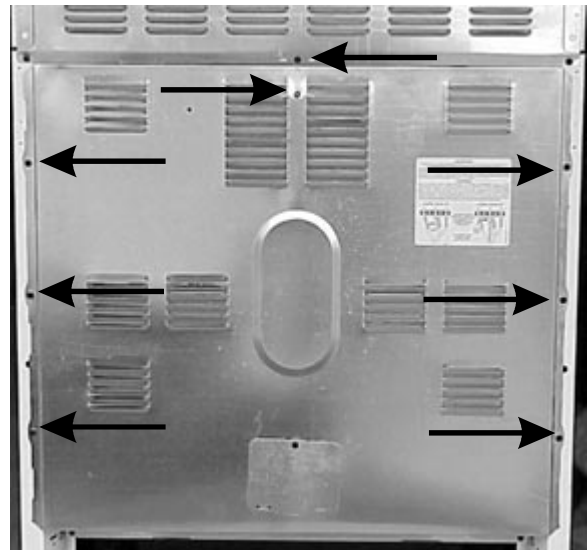

**Eight screws**

#### Removing lock motor assembly:

1. Disconnect power and remove back panel.
2. Mark and disconnect the wire from the assembly.
3. Remove the three screws holding the assembly to the range.

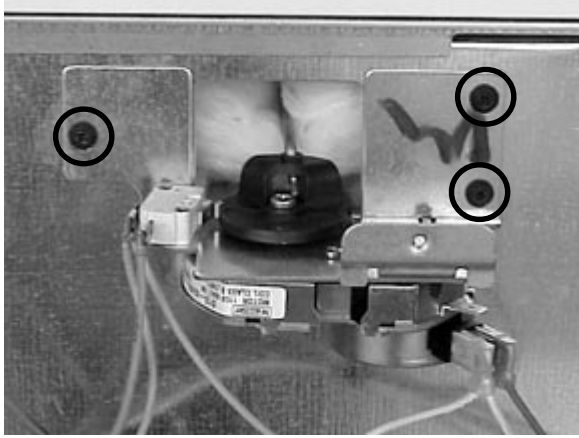

**Three screws**

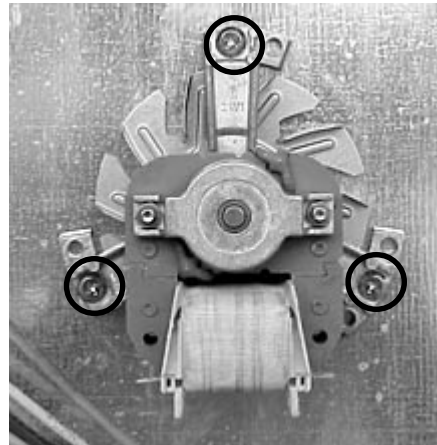

**Three screws**

4. Pull back on the assembly. Lift the rod and tip the front of the assembly down to release the rod.
5. If replacing the assembly be sure to transfer the spacing tab from old assembly to the new.

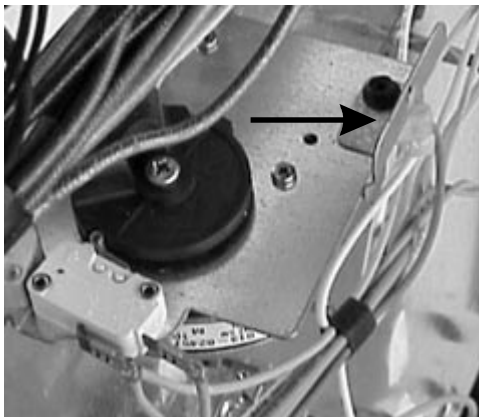

**Spacing tab**

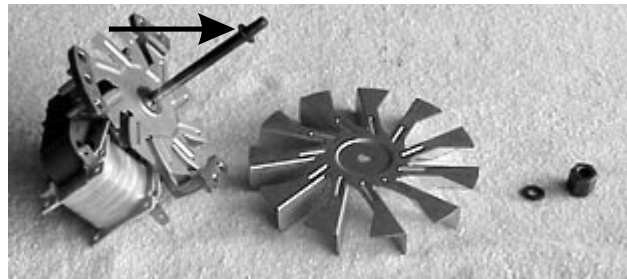

**C clip shown on shaft**

**Removing convection and speed bake motor assembly:**

1. Disconnect power and remove back panel.
2. Remove fan blade inside oven. (See fan blade removal.)
3. Mark and remove the wires from motor assembly.
4. Remove the three screws holding the assembly to the back of the range.
5. Pull the motor shaft out the back of the range.
6. The fan blade is spaced on the shaft by a C clip and the cooling fan blade is held in place on the shaft by a tennamen nut.

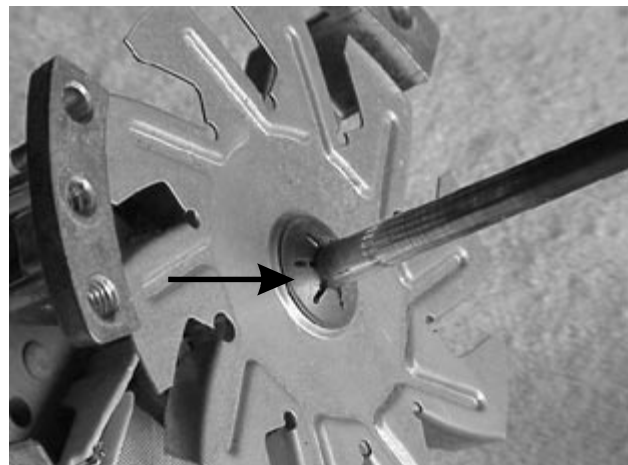

**Tennamen nut**

**Removing oven sensor:**

1. Disconnect power and remove back panel.
2. Unplug wires to the sensor.
3. Remove the two screws holding the sensor to the back of the range.

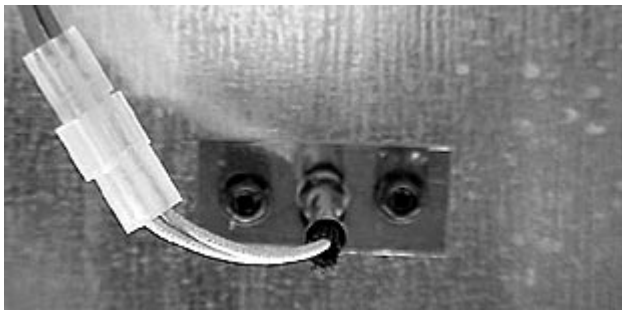

**Oven sensor mounting screws**

**Removing oven light socket:**

1. Disconnect power and remove back panel.
2. Remove oven light shield (self-clean models) and disconnect the wires from the light socket. Squeeze the spring loaded tabs on the sides of the socket and push the socket into the oven.



**Oven light socket**

**Removing mother board:**

1. Disconnect power and remove back panel.
2. Mark and disconnect the wires and unplug the harnesses from the board.
3. The board is held to the back of the range by two screws and four plastic rivets. Remove the two screws and squeeze the ends of the plastic rivets while pulling out on the board.

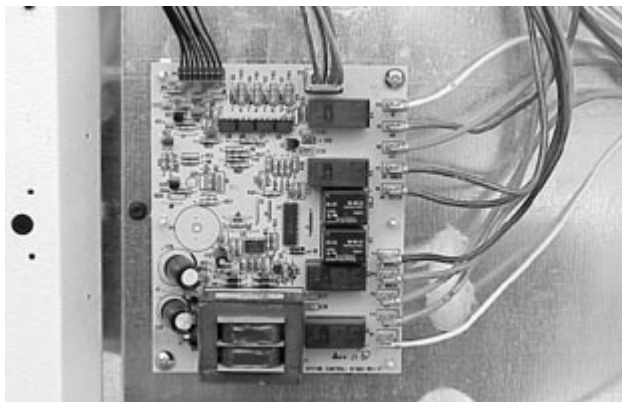

**Mother board mounting screws and rivets**

**Removing bodyside panels:**

1. Disconnect power remove the back of the control panel and the back panel.
2. Place a rug or padding under the range to protect the floor.
3. Remove the backguard end cap on the side of the range that the bodyside is being removed.
4. Remove the oven door and drawer.
5. Remove the six screws holding the bodyside panel to the back of the range.

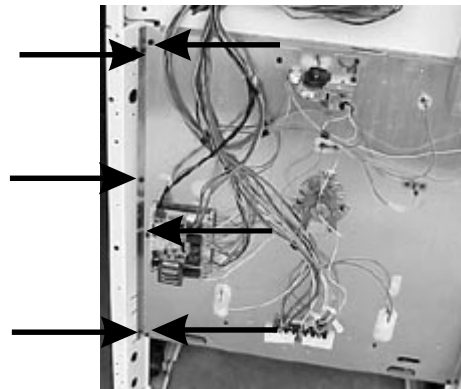

**Six bodyside panel screws**

6. Remove one screw in the back holding the bodyside panel to bottom rail.

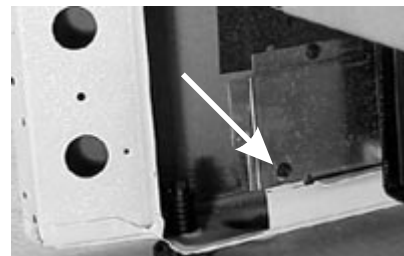

**Bodyside bottom rail screw**

7. Remove six screws from the front. It is not necessary to remove the two short screws holding the heat shield in the upper corner. But you do need to transfer this to the replacement panel if the panel is being replaced.
8. With one hand in the oven and the other in back lift the side of range with the bodyside you are removing and slide the bottom of the panel out.

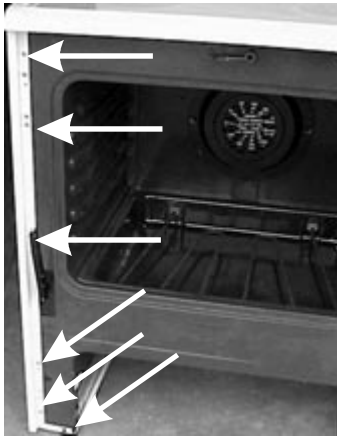

**Front bodyside panel screws**

**Storage Drawer**

**Removing the storage drawer front panel:**

1. Remove two screws from the upper inside panel.



**Two inside screws**

2. Remove two screws from the bottom edge of the panel.

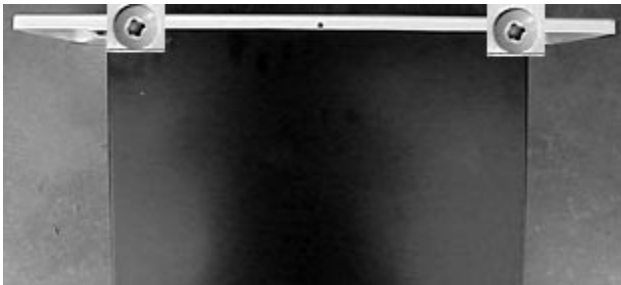

**Two bottom edge screws**

**Removing inside drawer panel:**

1. Remove four screws, two on each side holding the inner panel to the drawer.

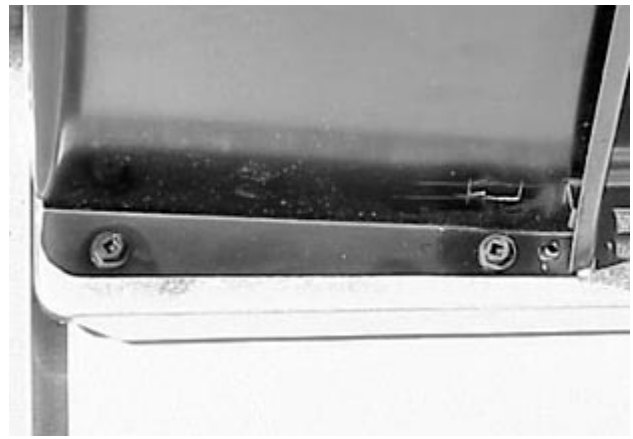

**Two screws on each side**

**Removing storage drawer glides:**

There are four drawer glides mounted to the drawer, one on each side in the front and one on each side in the rear:

1. Press in on the locking tab and pull the glide from the drawer.

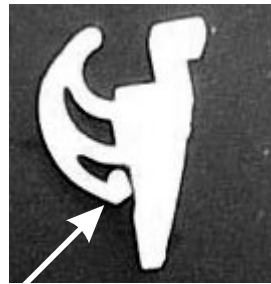

**Locking tab**

There are also two drawer glides mounted to the frame of the range, one on each side in the front.



**Drawer glide**

1. To remove the glide it is necessary to get behind the frame of the range.

2. Remove the side heat shield by removing four screws holding the shield to the frame and side panel. Turn the front leveling leg almost out and slide the shield back and out.
3. Reach behind the frame and release the glide.

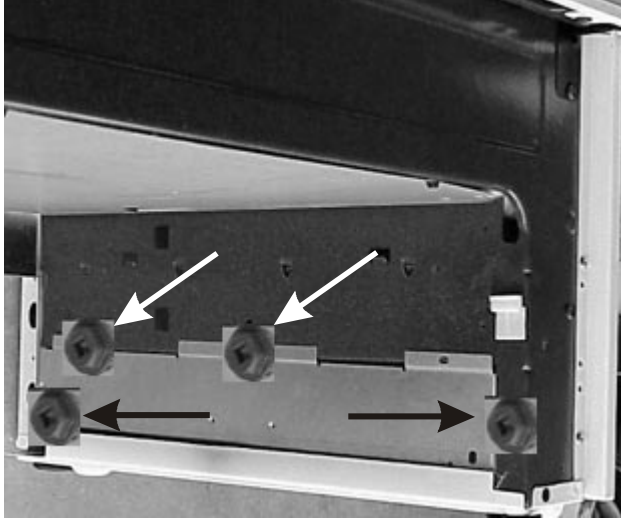

**Side heat shield screws**

**Removing the bottom heat shield:**

1. Remove the three screws holding the heat shield to the bottom wool shield, and allow the shield to drop down.

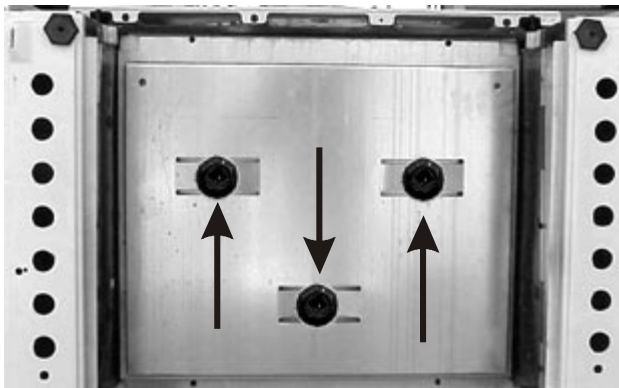

**Bottom heat shield screws**

**Removing bottom wool shield:**

1. Remove the heat shield.
2. Remove the four screws, two in the front and two in the back, holding the shield to the frame.

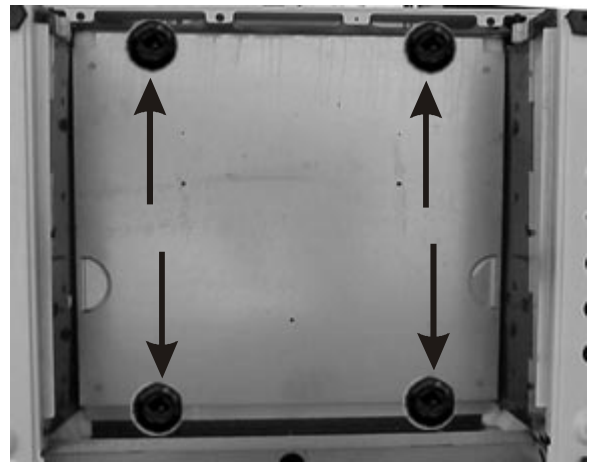

**Bottom wool shield screws**

**Removing the warmer drawer:**

1. Pull the drawer out to the stop.
2. There is a latch on each of the drawer glides. Lift the latch on the right side. Then push down on the latch on the left side and pull the drawer the rest of the way out.



**Right side latch**

**Removing the warmer drawer side rail:**

1. The side rail snaps to the side of the drawer. To remove the rail, lift up on the rail.



**Side rail**

### Removing drawer rail from range frame:

1. Remove the screw holding the rail to the frame and pull forward on the rail.

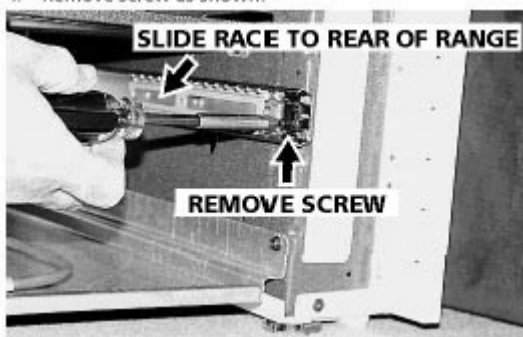

**Rail screw**

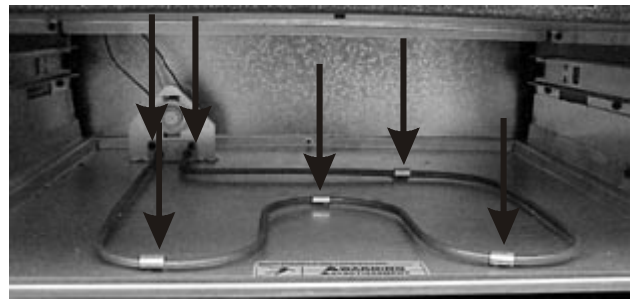

**Warmer drawer element screws**

### Removing warmer drawer low limit thermostat:

1. Disconnect power from range.
2. Remove wires from back of thermostat.
3. Remove the two screws holding the thermostat to the bracket and pull the thermostat forward.

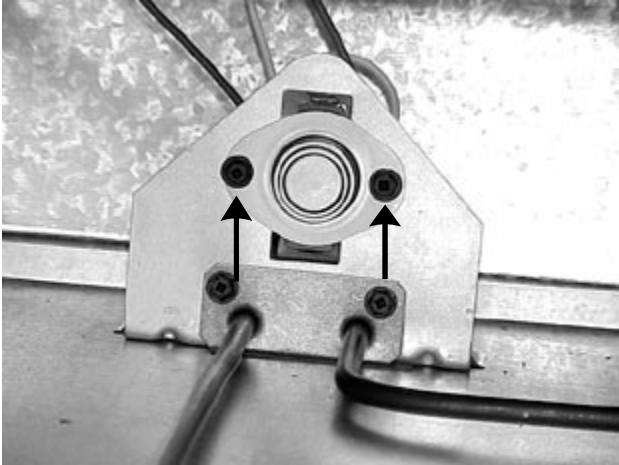

**Warmer drawer thermostat screws**

### Removing the warmer drawer element:

1. Disconnect power from range.
2. Remove wires from the element.
3. Remove the two screws holding the element to the bracket and the four screws holding the element to the base. Pull the element forward out of the bracket.



