



ELECTROLUX HOME PRODUCTS NORTH AMERICA

SERVICE MANUAL

30" and 40" ELECTRIC

FREESTANDING RANGES

FOR SERIAL NUMBERS STARTING WITH NF

Frigidaire

TAPPAN

WHITE-WESTINGHOUSE

Gibson

Kelvinator 

5995362828

August 2002

SAFE SERVICING PRACTICES - ALL APPLIANCES

To avoid personal injury and/or property damage, it is important that **Safe Servicing Practices** be observed. The following are some limited examples of safe practices:

1. **DO NOT** attempt a product repair if you have any doubts as to your ability to complete it in a safe and satisfactory manner.
2. Before servicing or moving an appliance:
 - Remove the power cord from the electrical outlet, trip the circuit breaker to the OFF position, or remove the fuse.
 - Turn off the gas supply.
 - Turn off the water supply.
3. Never interfere with the proper operation of any safety device.
4. **USE ONLY REPLACEMENT PARTS CATALOGED FOR THIS APPLIANCE. SUBSTITUTIONS MAY DEFEAT COMPLIANCE WITH SAFETY STANDARDS SET FOR HOME APPLIANCES.**
5. **GROUNDING:** The standard color coding for safety ground wires is **GREEN**, or **GREEN** with **YELLOW STRIPES**. Ground leads are not to be used as current carrying conductors. It is **EXTREMELY** important that the service technician reestablish all safety grounds prior to completion of service. Failure to do so will create a hazard.
6. Prior to returning the product to service, ensure that:
 - All electrical connections are correct and secure
 - All electrical leads are properly dressed and secured away from sharp edges, high-temperature components, and moving parts
 - All non-insulated electrical terminals, connectors, heaters, etc. are adequately spaced away from all metal parts and panels
 - All safety grounds (both internal and external) are correctly and securely connected
 - All panels are properly and securely reassembled

ATTENTION!!!

This service manual is intended for use by persons having electrical and mechanical training and a level of knowledge of these subjects generally considered acceptable in the appliance repair trade. Electrolux Home Products cannot be responsible, nor assume any liability, for injury or damage of any kind arising from the use of this manual.

SAFE SERVICING PRACTICES	2
QUICK REFERENCE SHEET	15
Serial number breakdown	15
Oven sensor resistance chart	15
Surface element resistance	15
Oven elements	15
Schematic codes	15
MAXIMUM ALLOWABLE SURFACE TEMPERATURES	16
SECTION A - 30" ELECTRIC FREESTANDING INSTALLATION INSTRUCTIONS	17 - 21
Clearances and dimensions	17
Serial plate information	18
Electrical connection requirements	18
Models requiring power supply cord kit	18
Permanent hard wiring (3 or 4 wires)	18
Wiring instructions – 3-wire supply cable	19
Grounding instructions	19
To remove ground link	19
Wiring instructions – 4-wire supply cable (mobile homes)	19
Leveling the range	20
Anti-tip bracket installation instructions	20
Tools you will need	20
For electrical supply connection	20
Additional materials you will need	20
Normal installation steps	20
Anti-tip bracket installation instructions	20
Locate the bracket using the template	20
Drill pilot holes and fasten bracket	21
Level and position range	21
SECTION A - 40" ELECTRIC FREESTANDING INSTALLATION INSTRUCTIONS	22 - 30
Clearances and dimensions	22
Important notes to the installer	23
Important safety instructions	23
For models with self-clean feature	24
Power supply cord kit	24
Range connection opening size chart	24
Electrical connection to the range	24
Three conductor wire connection to range	25
Four conductor wire connection to range (mobile homes)	25
Direct electrical connection to the circuit breaker, fuse box or junction box	26
Where local codes permit connecting the appliance grounding conductor to the neutral (white) wire	26
Where local codes DO NOT permit connection of the appliance grounding conductor to the neutral (white) wire or if connecting to 4-wire electrical system	26
Junction box location	27
Range placement	27
Range installation	27
Preparation	28
Leveling the range	28
Check operation	28
Operation of surface elements	28
Operation of oven elements	28
When all hookups are complete	29
Model and serial number location	29
Before you call for service	29

Important safety warning	29
Tools required	29
Anti-tip bracket installation instructions	29
SECTION B - ACCESSORIES	31
Fluorescent lamp	31
How the fluorescent lamp circuit operates	31
Troubleshooting the fluorescent lamp circuit	31
The light bulb flickers or only glows at the ends	31
Light bulb does not glow	31
120 volt outlet	31
SECTION C - SURFACE ELEMENT CONTROL SYSTEMS	32 - 39
Standard infinite switch	32 - 33
Troubleshooting	32
Element does not heat	32
Element does not cycle	33
Indicator light does not glow	33
Indicator light glows full brilliance with all top element switches off	33
Dual infinite switch	33 - 34
Troubleshooting	33
Both elements do not heat	34
Outer element doesn't heat, but inner element does	34
Inner element doesn't heat, but outer element does	34
Elements do not cycle	34
Indicator light does not glow	34
Indicator light glows full brilliance with all top element switches off	34
Top element electronic control system	35 - 38
Components of the system	35
How it operates	36
Troubleshooting the ESEC 5	36
F5 code	36
F6 code	37
F7 code	37
Blank display	38
Element not heating	38
Warm and serve zone	38 - 39
Troubleshooting	38
Element does not heat	38
Element does not cycle	39
Indicator light does not glow	39
Indicator light glows full brilliance with the warm and serve switch turned off	39
SECTION D - ELECTRONIC OVEN CONTROL SYSTEMS	40 -100
The ES 100 electronic oven control system	40 - 44
How to program the ES 100	40
To set the clock	40
To set the minute timer	40
To change the minute timer while it is in use	40
To cancel the minute timer before the set time has run out	41
To set or change the temperature for baking	41
To set the controls for baking	41
To change the oven temperature after baking has started	41
To broil	41
How the ES 100 operates	41
Bake	41
Broil	41

Calibration	42
To check oven calibration	42
The calibration of the ES100 system cannot be adjusted	42
Troubleshooting	42
F1 code	42
F3 code	42
Control will not program	42
Blank Display	42
No heat	42
If the control appears to be operating normally but the bake and broil elements do not heat	42
If the control appears to be operating normally, the broil element heats but the bake element does not heat	43
If the control appears to be operating normally, the bake element heats, but the broil element does not heat	43
Sample schematic for ES 100 control system	44
The ES 200 electronic oven control system	45 - 50
How to program the ES 200	45
Temperature conversion	45
To change the temperature from °F to °C or from °C to °F	45
To set the clock	45
To set the minute timer	45
To change the minute timer while it is in use	46
To cancel the minute timer before the set time has run out	46
To set or change the temperature for baking	46
To set the controls for baking	46
To change the oven temperature after baking has started	46
To set control for continuous bake or 12 hour energy saving	46
To set control for continuous baking	46
To set control for oven lockout feature	46
To broil	46
To set the controls for a self-clean cycle	47
When the self-clean cycle is completed	47
Stopping or interrupting a self-cleaning cycle	47
How the ES 200 operates	47
Bake	47
Broil	48
Clean	48
Calibration	48
To check oven calibration	48
To change the calibration	48
Troubleshooting	48
F1 code	48
F3 code	48
F9 code	49
Control will not program	49
Blank Display	49
No heat	49
If the control appears to be operating normally but the bake and broil elements do not heat	49
If the control appears to be operating normally, the broil element heats but the bake element does not heat	49

If the control appears to be operating normally, the bake element heats, but the broil element does not heat	49
Oven door does not lock when the oven is programmed for clean	49
Oven door locks when the oven is programmed for clean but the oven does not heat	49
Lock motor runs continuously	50
Door latch is partly closed with door open, cannot close door	50
Sample schematic for ES 200 control system	51
The ES 300 electronic oven control system	52 - 60
How to program the ES 300	52
For a silent control panel	52
Temperature conversion	52
To change the temperature from °F to °C or from °C to °F	52
To set the clock	52
To set the minute timer	52
To change the minute timer while it is in use	53
To cancel the minute timer before the set time has run out	53
To set or change the temperature for baking	53
To set the controls for baking	53
To change the oven temperature after baking has started	53
To set control for continuous bake or 12 hour energy saving	53
To set control for continuous baking	53
To set control for oven lockout feature	53
To set the timed bake feature	53
To program the oven to begin baking immediately and to shut off automatically	53
To program oven for a delayed start time and to shut-off automatically	54
To change the oven temperature or bake time after baking has started	54
Speed Bake	54
General cooking instructions	54
To set Speed Bake™ cooking system	54
To broil	55
Self-cleaning oven	55
Adhere to the following cleaning precautions	55
To set the controls for a self-clean cycle	56
When the self-clean cycle is completed	56
Stopping or interrupting a self-cleaning cycle	56
How the ES 300 control system works	56
Bake	56
Time bake	57
Broil	57
Speed bake	57
Clean	57
Calibration	57
To check oven calibration	57
To change the calibration	57
Troubleshooting	57
F1 code	57
F3 code	58
F9 code	58
Control will not program	58
Time bake does not operate	58

Blank Display	58
No heat	58
If the control appears to be operating normally but the bake and broil elements do not heat	58
If the control appears to be operating normally, the broil element heats but the bake element does not heat	58
If the control appears to be operating normally, the bake element heats, but the broil element does not heat	58
Oven door does not lock when the oven is programmed for clean	59
Oven door locks when the oven is programmed for clean but the oven does not heat	59
Lock motor runs continuously	
Door latch is partly closed with door open and cannot close door	59
Fan in oven does not run when speed bake switch is turn on	59
Sample schematic for ES 300 control system	60
The ES 400 electronic oven control system	61 - 70
How to program the ES 400	61
Clock	61
To set the clock	61
Changing between 12 or 24 hour time of day display	61
Continuous bake or 12 hour energy saving	61
To set the control for continuous bake or 12 hour energy saving	61
Minute timer	62
To set the minute timer	62
To change the minute timer while it is in use	62
To cancel the minute timer before the set time has run out	62
Oven lockout feature	62
To activate the oven lockout	62
To reactivate oven operation	62
Temperature display - Fahrenheit or Celcius	62
To change the temperature from °F to °C or from °C to °F	62
Silent control operation	62
To change control from normal sound operation to silent control operation	62
Preheat	63
To set the preheat temperature	63
To change the preheat temperature while the oven is preheating	63
Bake	63
To set the bake temperature	63
To change the bake temperature	63
Timed bake	63
To program the oven to begin baking immediately and to shut off automatically	63
To program oven for a delayed start time and to shut-off automatically	64
To broil	64
To set the oven to broil	64
Convection bake	65
To set the convection bake feature	65

Convection roast _____	65
To set the convection roast feature _____	65
Self-clean cycle _____	65
To set the controls for the self-cleaning cycle to start immediately and shut off automatically _____	65
When the self-clean cycle is completed _____	66
Stopping or interrupting a self-cleaning cycle _____	66
How the ES 400 control system works _____	66
Preheat _____	66
Bake _____	66
Time bake _____	66
Convection bake _____	66
Convection roast _____	67
Broil _____	67
Clean _____	67
Calibration _____	67
To check oven calibration _____	67
To change the calibration _____	67
To adjust the oven temperature higher _____	67
To adjust the oven temperature lower _____	67
Troubleshooting _____	67
F1 code _____	67
F3 code _____	67
F9 code _____	68
Control will not program _____	68
Time bake does not operate _____	68
Convection bake and convection roast _____	68
Neither the fan motor or the assist element operates _____	68
If either convection bake or convection roast operate normally but the other does not _____	68
Fan motor does not operate _____	68
Convection element does not operate _____	68
Control does not operate in preheat _____	68
Blank display _____	68
Bake element does not heat _____	68
Broil element does not heat _____	69
Oven door does not lock when the oven is programmed for clean _____	69
Oven door locks but the oven does not heat _____	69
Door latch is partly closed with door open _____	69
Sample schematic for ES 400 control system _____	70
The ES 450 Electronic Oven Control System _____	71 - 80
How to program the ES 450 _____	71
Clock _____	71
To set the clock _____	71
Changing between 12 or 24 hour time of day display _____	71
Continuous bake or 12 hour energy saving _____	71
To set the control for continuous bake or 12 hour energy saving _____	71
Minute timer _____	72
To set the minute timer _____	72
To change the minute timer while it is in use _____	72
To cancel the minute timer before the set time has run out _____	72
Oven lockout feature _____	72
To activate the oven lockout _____	72
To reactivate oven operation _____	72

Temperature display - Fahrenheit or Celcius _____	72
To change the temperature from °F to °C or from °C to °F _____	72
Silent control operation _____	72
To change control from normal sound operation to silent control operation _____	72
Preheat _____	73
To set the preheat temperature _____	73
To change the preheat temperature while the oven is preheating _____	73
Bake _____	73
To set the bake temperature _____	73
To change the bake temperature _____	73
Timed bake _____	73
To program the oven to begin baking immediately and to shut off automatically _____	73
To program the oven for a delayed start time and to shutoff automatically _____	74
When the set bake time runs out _____	74
Broil _____	74
To set the oven to broil _____	74
Convection bake _____	75
To set the convection bake feature _____	75
Setting food catagories feature _____	75
To set the food catagories feature _____	75
Self-clean cycle _____	75
To set the controls for the self-cleaning cycle to start immediately and shut off automatically _____	76
When the self-clean cycle is completed _____	76
Stopping or interrupting a self-cleaning cycle _____	76
How the ES 450 works _____	76
Preheat _____	76
Bake _____	76
Time bake _____	76
Convection bake _____	77
Fixed Settings _____	77
Meats _____	77
Cakes _____	77
Breads _____	77
Broil _____	77
Clean _____	77
Calibration _____	77
To check oven calibration _____	77
To change the calibration _____	77
To adjust the oven temperature higher _____	77
To adjust the oven temperature lower _____	78
Troubleshooting _____	78
F1 code _____	78
F3 code _____	78
F9 code _____	78
Control will not program _____	78
Time bake does not operate _____	78
Convection bake _____	78
Neither the fan motor or the assist element operates _____	78
Fan motor does not operate _____	78
Convection element does not operate _____	79
Control does not operate in preheat _____	79

Blank display	79
Bake element does not heat	79
Broil element does not heat	79
Oven door does not lock when the oven is programmed for clean	79
Oven door locks but the oven does not heat	79
Door latch is partly closed with door open	79
Sample schematic for ES 450 control system	80
The PRC Glass touch electronic oven control models	81 - 98
How to program the the PRC Glass touch	81
Control Pad Functions	81
Electronic Oven Control	82
Clock	82
To set the clock	82
To change from 12 to 24 hour time of day operation	82
To reactivate the energy saving mode	82
Timer reminder	83
To deactivate the timer reminder	83
To reactivate the timer reminder	83
Kitchen timer	83
To set the kitchen timer	83
To change the minute timer while it is in use	83
To cancel the minute timer before the set time has run out	83
Child safety lockout feature	84
To activate the child safety lockout	84
To reactivate oven operation	84
Temperature display - Fahrenheit or Celsius	84
To change from Fahrenheit to Celsius or Celsius to Fahrenheit	84
Preheat	84
To set the preheat temperature	84
To change the present preheat temperature	85
Bake	85
To set the bake temperature	85
To change the present bake temperature	85
Broil	86
To set the oven to broil	86
To change the present broil temperature	86
Convection bake	87
To set the oven to convection bake	87
To change the present convection bake temperature	87
Convection roast	88
To set the oven to convection roast	88
To change the present convection roast temperature	88
Timed bake	89
To program the oven to begin immediately and to shut off automatically	89
When the set bake time runs out	89
Delayed timed bake	90
To program oven for a delayed start time and shut-off automatically	90
When the set bake time runs out	90
To start the self-clean cycle	91
To set the controls for the self-cleaning cycle to start immediately and shut off automatically	91
When the Self-clean cycle is completed	91

Stopping or interrupting a self-cleaning cycle	91
To start the delayed self-clean cycle	92
To set the control for the self-cleaning cycle to start at a delayed time and shut off automatically	92
When the self-clean cycle is completed	92
Adjusting oven temperature	93
To adjust oven temperature	93
Failure modes	93
How the PRC Glass touch electronic oven control works	94
Capacitance touch glass	94
Preheat	94
Bake	94
Timed bake	94
Convection bake	94
Convection roast	94
Broil	94
Clean	95
Calibration	95
To check oven calibration	95
To change the calibration	95
To adjust the oven temperature lower	95
Troubleshooting	95
F1 code	95
F3 code	95
F9 code	96
Control will not program	96
Time bake does not operate	96
Convection bake	96
Fan motor does not operate	96
Convection element does not heat	96
Control does not operate in preheat	96
Blank display	96
Bake element does not heat	96
Broil element does not heat	96
Oven door does not lock when the oven is programmed for clean	97
Oven door locks but the oven does not heat	97
Door latch is partly closed with door open	97
Sample schematic for PRC Glass touch control system	98
Warmer drawer	99
To set the warmer drawer thermostat control	99
How the warmer drawer circuit works	99
Troubleshooting	99
If the element does not heat	99
If the element heats during preheat, then stays off until the temperature drops to about 130° F	100
If the element does not cycle off	100
If the warmer drawer is slow preheating	100
If the warmer drawer heats, but the indicator light does not glow	100
SECTION E - 30" DISASSEMBLY AND REPLACEMENT OF PARTS	101 - 122
Top trim on backguard area	101
Removing the 15 amp fuse	101
Removing the fluorescent lamp starter	101
To roll the control mounting panel forward	101
Removing the 120 volt outlet	101
Removing the oven light or fluorescent switch	102

Removing the top trim	102
Removing the knobs	102
Removing the backguard glass	102
Removing the timer (models with thermostats)	102
Removing electronic oven control	103
Top element switches	103
Oven selector switch (models with oven thermostats)	103
Oven thermostats	103
Removing the large element safety thermostat	104
Removing indicator lights	105
Removing the fuse socket	105
Removing fluorescent starter socket	105
Removing terminal block	105
Removing the end caps	106
Removing the bottom glass trim	106
Removing fluorescent light socket	106
Main top area	106
Removing coil elements and drip pans	106
Raising main top (smooth top models)	106
Removing the elements (smooth top models)	107
Terminal block	107
Removing the main top lift and lock rods coil element models	108
Removing the main top (coil element models)	106
Removing the main top (smooth top models)	108
Removing the main top hinge	108
Removing the burner pan (coil models)	109
Oven door area	109
Removing the oven door seal	109
Removing the oven door	110
Removing the bottom trim and outer door glass	110
Removing the upper door trim and handle	110
Removing the door handle	110
Removing the side trim	110
Removing the door hinge	110
Removing the inner door heat shield	111
Removing the inner door glass frame	111
Removing the inner door glass	111
Removing the inner door glass seal	111
Inside the oven	112
Removing the bake element	112
Removing the broil element	112
Removing oven sensor	112
Removing the fan blade cover (convection and speed bake models)	113
Removing the fan blade (convection and speed bake models)	113
Removing the assist element (convection models)	113
Removing the oven vent (coil top models and bottom part of the vent system on smooth top models)	113
Removing the upper oven vent (smooth top models)	113
Removing the oven light shield (self-clean models)	114
Removing the oven light socket	114
Storage drawer area	114
Storage drawer front panel	114
Storage drawer body	114
Removing the drawer rollers	114
Removing the drawer glide	115

Warmer drawer area	115
Removing the warmer drawer	115
Removing the drawer seal	115
Removing the outer drawer panel	115
Removing the inner drawer panel	115
Removing side rail on from the drawer	116
Removing the drawer glides	116
Removing the warmer drawer element	116
Removing the warmer drawer thermostat	116
Removing the diode and warmer element terminal cover	117
Removing the warmer drawer diode	117
Removing the warmer drawer cavity	117
Removing the top of the warmer drawer cavity	118
Removing the bottom of the warmer drawer cavity	118
Removing the front roller	118
Removing the front roller bracket	118
Removing the rear roller	118
Removing the leveling leg and roller assembly	119
Removing the wool shield	119
Components mounted to the rear of the range	119
Removing the large rear panel	119
Removing small panel	120
Removing the oven thermo cutout	120
Removing the fluorescent light ballast	120
Removing the convection fan or speed bake motor	120
Removing the lock motor assembly	121
Removing the power supply cord	121
Removing the bodyside	121
Removing the door switch	122
Removing the hinge roller brackets	122
SECTION E - 40" DISASSEMBLY AND REPLACEMENT OF PARTS	123 - 138
Top trim on backguard area	123
Removing the fluorescent light bulb	123
Removing the fluorescent light starter	123
Removing backguard backpanel	123
Removing the fluorescent light socket	123
Removing the fluorescent ballast	123
Removing the thermostat and top element knobs	124
Removing top element switch	124
Removing the small oven thermostat	124
Removing indicator lights	125
Removing the light switches	125
Removing the electronic oven control	125
Removing the end cap	125
Removing the control panel end bracket	125
Removing the control panel	126
Main top area	126
Removing coil elements and drip pans	126
Removing the terminal block	126
Removing the main top	126
Removing rear hinge	127
Removing the lock rod	127
Removing the oven door latch plate	127
Removing the small oven door hinges	127
Removing the front oven trim	128
Large oven door area	128
Removing the large oven door's door seal self-clean models	128

Removing the large oven door	128
Removing the large oven door outer panel	129
Removing the large oven door outer panel glass seal	129
Removing the large door small heat shield and door handle	129
Removing the large door outer glass	129
Removing the large door heat barrier glass	129
Removing the wool shield	130
Removing the door hinge	130
Removing the middle glass and wool spacer in the large oven door	130
Removing the inner glass in the large oven door	130
Removing the seal between the inner glass and the inner door liner in the large oven door	131
Small oven door area	131
Removing the small door seal	131
Removing the small door magnetic latch	131
Removing the small oven door outer panel	131
Removing the small door door handle	131
Removing the small door heat shield	131
Large oven area	132
Removing large oven bake element	132
Removing the broil element large oven	132
Removing the oven sensor in the large oven	132
Removing the large oven vent	133
Removing the oven light shield in the large oven	133
Removing the oven light socket in the large oven	133
Small oven area	133
Removing the small oven bake element	133
Removing the small oven broil element	134
Removing the small oven vent	134
Storage drawer area	134
Removing the storage drawer bottom sweep	134
Removing the storage drawer panel	134
Removing the drawer glide	135
Removing the drawer glide and rail on the chassis	135
Rear of the range area	135
Removing the large rear panel	135
Removing the lock motor assembly	135
Removing small rear panel	135
Removing the thermal circuit breaker	135
Bodyside	136
Removing the righthand bodyside	136
Removing the side heat shield	137
Removing door switch	137
Removing the large door righthand hinge roller bracket	138
Removing the large door lefthand hinge roller bracket	138

QUICK REFERENCE SHEET

1. Serial number breakdown

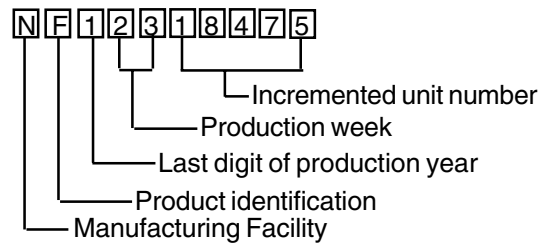

2. Oven sensor resistance chart

RTD	SCALE
Temperature Degrees F.	Resistance (Ohms)
32 +/- 1.9	1000 +/- 4.0
75 +/- 2.5	1091 +/- 5.3
250 +/- 4.4	1453 +/- 8.9
350 +/- 5.4	1654 +/- 10.8
450 +/- 6.9	1852 +/- 13.5
550 +/- 8.2	2047 +/- 15.8
650 +/- 9.6	2237 +/- 18.5
900 +/- 13.6	2697 +/- 24.4

3. Surface element resistance

The wattage rating is stamped on the element. To determine the resistance divide the wattage by the voltage rating on the element (either 240 or 120) to obtain the amperage. Then divide the amperage into the voltage rating to obtain the resistance. If for some reason you cannot find the wattage rating, as a general rule most element's resistance will be between 15 and 45 Ohms.

4. Oven elements

Bake elements	Watts	Ohms
	2400	24
	3000	19.2
	3400	16.9
Broil element	2750	20.8
Convection elements	350	41
	2500	23

5. Schematic codes

SW	=	Switch
O. C.	=	Oven Control
S. S.	=	Selector Switch
S. T.	=	Safety Thermostat
R. F.	=	Right Front
R. R.	=	Right Rear
L. F.	=	Left Front
L. R.	=	Left Rear
S. L. S.	=	Surface Lamp Switch
O. L. S.	=	Oven Lamp Switch
P. L.	=	Pilot Light
A. D. S.	=	Auto Door Switch
T. P.	=	Thermal Protector
SM. T.	=	Smooth Top
QBF	=	Quick Bake Fan
QB SW.	=	Quick Bake Switch
DLB	=	Double Line Break
DR LAT MTR	=	Door Latch Motor

MAXIMUM ALLOWABLE TEMPERATURES (for gas & electric cooking products):

When Electrolux tests side panels and doors for surface temperature, certain U.L. and/or A.G.A. guide lines must be followed.

1. Product must be undamaged, correctly assembled and have the correct oven test temperature.
2. All surface temperatures are based on a room temperature of 77° F (25° C) and an oven set temperature of 400° F.
3. Oven must be cycling at 400° F for one hour before test is conducted.
4. Pyrometers (temperature testers) must be of high quality and properly adjusted.
5. An increase or decrease of 1° F in the room ambient temperature will allow a 1° F increase or decrease in the maximum allowable surface temperature of the range.

Side Panel, Painted 152° F

Side Panel, Porcelain 160° F

Oven Door, Glass 172° F

Oven Door, Painted 152° F

Oven Door, Porcelain 160° F

Warmer Drawer, Painted 152° F

Warmer Drawer, Porcelain 160° F

Cooktop, No Temperature Limits Apply

Lower Console, No Temperature Limits Apply

Oven Vent Area, No Temperature Limits Apply

	Knobs and Handles		Skirt	
	Plastic*	Metal	Plastic*	Metal
Conventional Gas & Electric	167° F	131° F	182° F	152° F
Self-Clean Gas at Clean Temperature	167° F	131° F	182° F	152° F
Self-Clean Gas at Clean Temperature	182° F	152° F	182° F	152° F

* Includes plastic with metal plating not more than 0.005" thick and metal with a plastic or vinyl covering not less than 0.005" thick

SECTION A - 30" ELECTRIC FREESTANDING INSTALLATION INSTRUCTIONS

**INSTALLATION AND SERVICE MUST BE PERFORMED BY A QUALIFIED TECHNICIAN.
IMPORTANT: SAVE FOR THE LOCAL ELECTRICAL INSPECTOR'S USE.
READ AND SAVE THESE INSTRUCTIONS FOR FUTURE REFERENCE.**

1. Clearances and Dimensions

- Provide adequate clearances between the range and adjacent combustible surfaces.
- Location—Check location where the range will be installed. Check for proper electrical supply and the stability of floor.
- Dimensions that are shown must be used. Given dimensions provide minimum clearance. Contact surface must be solid and level.

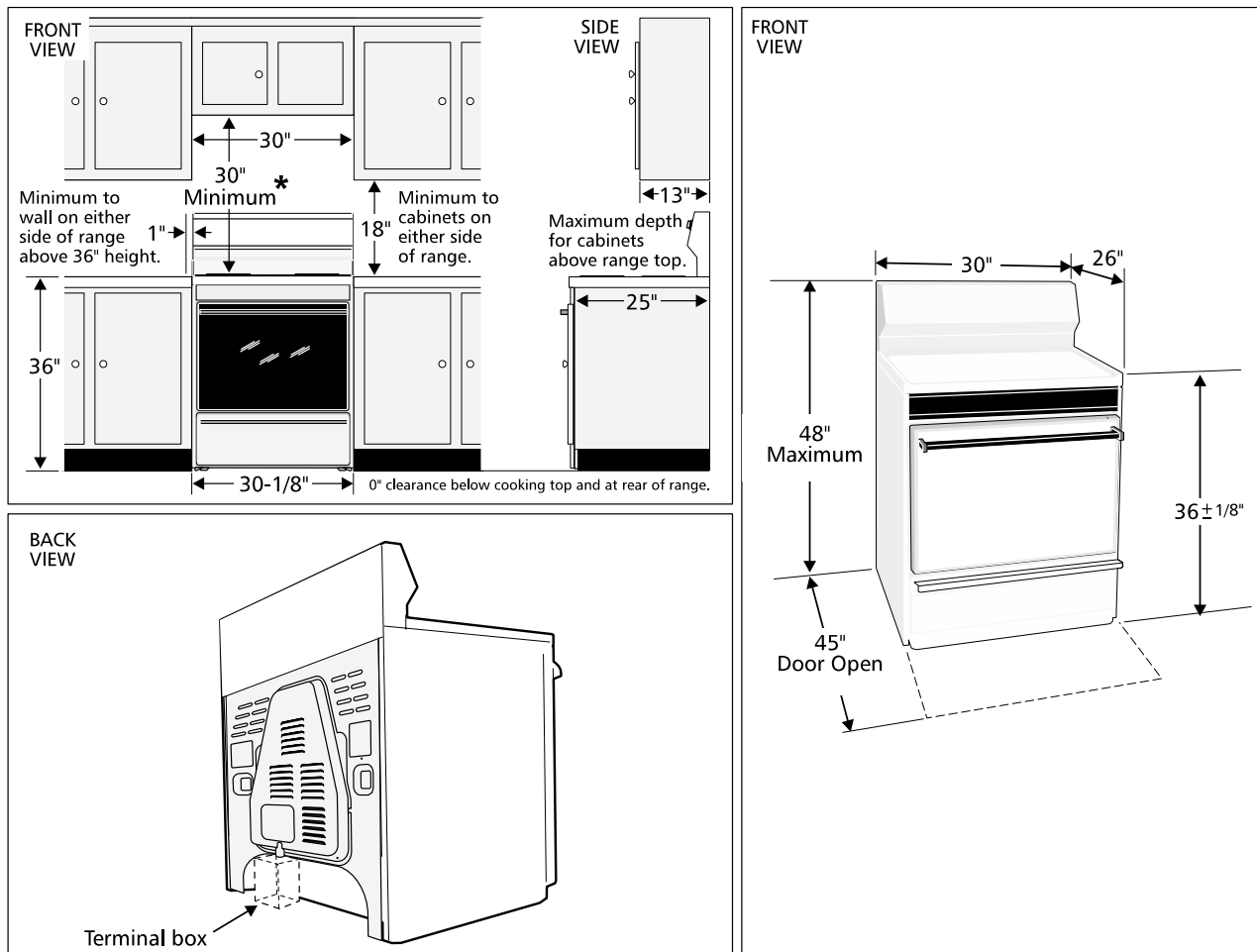

30" MINIMUM CLEARANCE BETWEEN THE TOP OF THE COOKING SURFACE AND THE BOTTOM OF AN UNPROTECTED WOOD OR METAL CABINET; OR 24" MINIMUM WHEN BOTTOM OF WOOD OR METAL CABINET IS PROTECTED BY NOT LESS THAN 1/4" FLAME RETARDANT MILLBOARD COVERED WITH NOT LESS THAN NO. 28 MSG SHEET STEEL, 0.015" STAINLESS STEEL, 0.024" ALUMINUM OR 0.020" COPPER. 0" CLEARANCE IS THE MINIMUM FOR THE REAR OF THE RANGE. FOLLOW ALL DIMENSION REQUIREMENTS PROVIDED ABOVE TO PREVENT PROPERTY DAMAGE, POTENTIAL FIRE HAZARD, AND INCORRECT COUNTERTOP AND CABINET CUTS.

TO ELIMINATE THE RISK OF BURNS OR FIRE BY REACHING OVER HEATED SURFACE UNITS, CABINET STORAGE SPACE LOCATED ABOVE THE SURFACE UNITS SHOULD BE AVOIDED. IF CABINET STORAGE IS TO BE PROVIDED, THE RISK CAN BE REDUCED BY INSTALLING A RANGE HOOD THAT PROJECTS HORIZONTALLY A MINIMUM OF 5" BEYOND THE BOTTOM OF THE CABINETS.

2. Install Anti-Tip Bracket(s).

3. Serial Plate Information

The serial plate is located on the frame and is visible when the drawer is opened.

See the serial plate for the following information:

- A. Model, lot and serial number of range.
- B. Kilowatt rating (power requirements).
- C. Voltage ratings.

4. Electrical Connection Requirements

This appliance must be properly installed and grounded by a qualified technician in accordance with the National Electrical Code ANSI/NFPA No. 70--latest edition--and local electrical code requirements.

This appliance may be connected by means of permanent "Hard Wiring" or "Power Supply Cord Kit."

When hard wiring, do not leave excess wire in range compartment. Excess wire in the range compartment may not allow the access cover to be replaced properly, and could create a potential electrical hazard if wires become pinched. Connect only as instructed under "WIRING INSTRUCTIONS" in sections 6 and 7. When using flexible conduit or range cable, use flex connector or range cable strain relief.

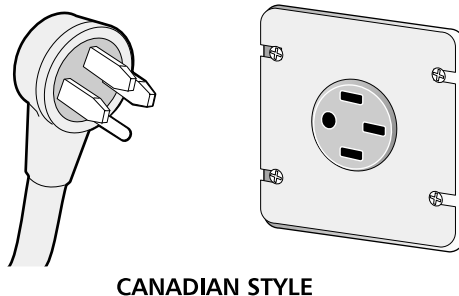
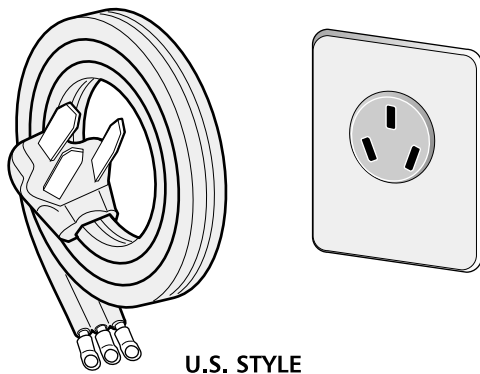

Figure 1

NOTE: Only use copper wire in connection to terminal block.

4B. Models Requiring Power Supply Cord Kit

⚠ WARNING RISK OF FIRE OR ELECTRICAL SHOCK MAY OCCUR IF AN INCORRECT SIZE RANGE CORD KIT IS USED, THE INSTALLATION INSTRUCTIONS ARE NOT FOLLOWED OR STRAIN RELIEF BRACKET IS DISCARDED.

This appliance may be connected by means of a power supply cord. Only a power supply cord kit rated at 40 amperes, 125/250 volts minimum, and marked for use with ranges shall be used. Cord must have three (3) conductors. Terminals on end of wires must be either closed loop or open-end spade lugs with upturned ends. Cord must have strain relief clamp.

NOTE: MOBILE HOME INSTALLATION OR AREAS WHERE LOCAL CODES DO NOT PERMIT GROUNDING THROUGH NEUTRAL, A FOUR (4) CONDUCTOR POWER CORD MUST BE USED.

A 1-3/8" knock-out hole is provided at the bottom of the range terminal box for connecting the power supply cord kit to the range terminal block (see Figures 2 and 3).

5. Permanent Hard Wiring (3 or 4 Wires)

Insert the residence 3-wire power supply cable through the 1-1/8" hole at the bottom of the range terminal box (see Figure 2). For mobile home application or where connections with a 3-wire power supply cable is not allowed, use a 4-wire power supply cable (for connections, see Figure 3). Use a U.L. approved strain relief clamp to secure the cable to the terminal box.

6. Wiring Instructions – 3-Wire Supply Cable

⚠ WARNING ELECTRICAL GROUND IS REQUIRED ON THIS APPLIANCE.

This appliance is manufactured with the neutral terminal connected to the frame. If local codes permit connection of the frame grounding conductor to the neutral wire of the copper power supply cord:

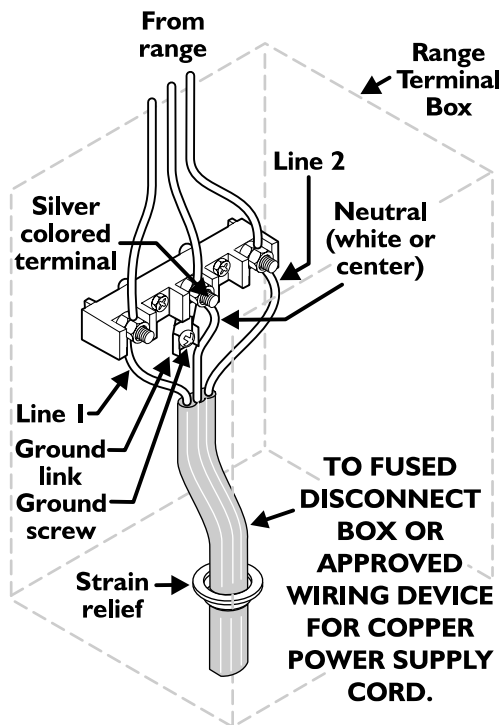

Figure 2

- A. Remove the 2 screws and remove terminal box cover.
- B. Remove the 3 loose nuts (after you removed the rubber band) on the terminal block using 3/8" nut driver or socket.
- C. Attach cable or pigtail to the 3 studs on terminal block, as local codes require. **The neutral wire (white) or center wire must be connected to center terminal.**
- D. Reinstall terminal box cover.

CAUTION Do not loosen nuts which secure the factory installed range wiring to terminal block while connecting range. Electrical failure or loss of electrical connection may occur.

GROUNDING INSTRUCTIONS

A ground link is installed on this range which connects the center terminal of the terminal block (neutral) to the chassis. The ground link is connected to the range by the center ground screw. The ground link must not be removed unless national or local codes do not permit use of the ground link.

NOTE: If the ground link is removed for any reason,

a separate ground wire must be connected to the separate ground screw attached to the range chassis, and to an adequate ground source.

If used in a mobile home or if local codes do not permit grounding through the neutral, use ground lead or ground screw to ground unit in accordance with local codes. Connect neutral to branch circuit.

To Remove Ground Link:

1. Remove ground link screw using a Phillips screwdriver. Save screw for future use.
2. Bend up ground link so that it does not contact the range.

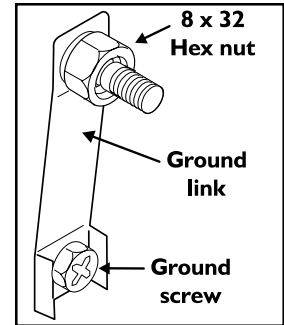

7. Wiring Instructions – 4-Wire Supply Cable (Mobile Homes)

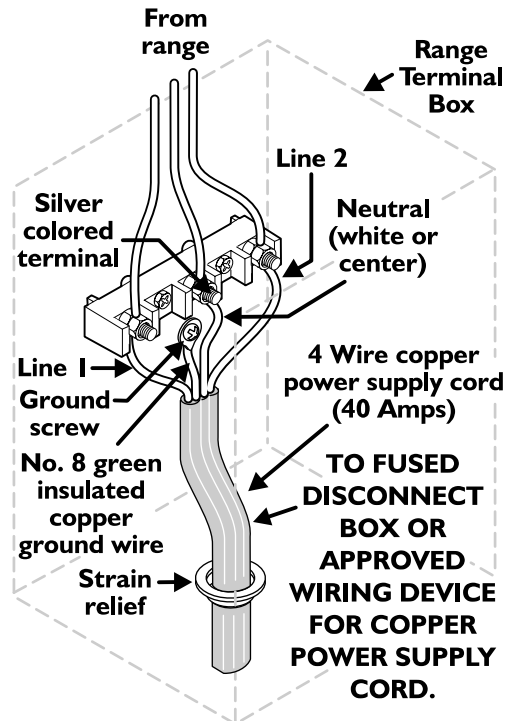

Figure 3

- A. Remove the 2 screws and remove terminal box cover.
- B. Remove ground link from terminal box and from appliance frame. Retain ground screw.
- C. Connect ground wire (green) of copper power supply cord to frame of appliance with ground screw, using hole in frame where ground strap was removed (see Figure 3).

D. Connect neutral (white) wire of copper power supply cord to center silver colored terminal of terminal box, and connect the other wires to outer terminals using the 3 loose nuts on the terminal block to terminal box using 3/8" nut driver or socket.

E. Reinstall terminal box cover.

8. Leveling the Range

Place a level on a properly installed oven rack. Adjust the leveling legs under the bottom corners of the range until the range is level.

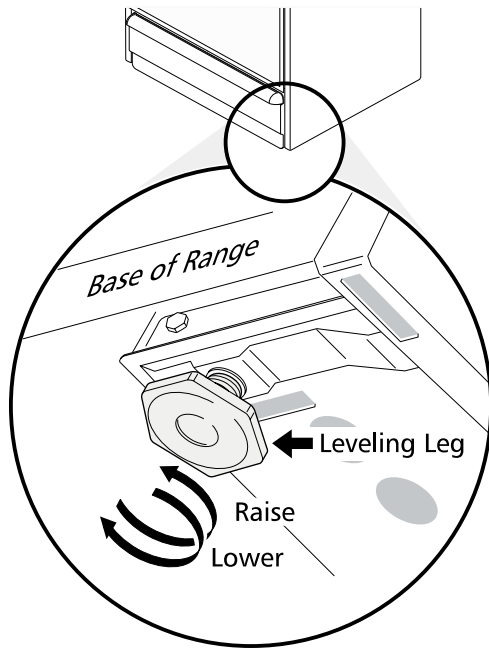

9. Anti-Tip Bracket Installation Instructions

Before Starting - Tools You Will Need:

For leveling legs and Anti-Tip Bracket:

- Adjustable wrench or channel lock pliers

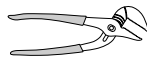

- 5/16" Nutdriver or Flat Head Screwdriver

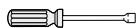

- Electric Drill & 1/8" Diameter Drill Bit (Masonry Drill Bit if installing in concrete)

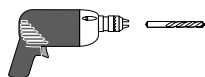

For electrical supply connection:

- 1/4" & 3/8" Socket driver or Nutdriver 

Additional Materials You Will Need

- Power Supply Cord or 
- Copper Electrical Wiring & Metal Conduit (for hard wiring)

Normal Installation Steps

1. Anti-Tip Bracket Installation Instructions

Important Safety Warning - To reduce the risk of tipping of the range, the range must be secured to the floor by properly installed anti-tip bracket and screws packed with the range. Failure to install the anti-tip bracket will allow the range to tip over if excessive weight is placed on an open door or if a child climbs upon it. Serious injury might result from spilled hot liquids or from the range itself.

If range is ever moved to a different location, the anti-tip brackets must also be moved and installed with the range.

Instructions are provided for installation in wood or cement fastened to either the floor or wall. When installed to the wall, make sure that screws completely penetrate dry wall and are secured in wood or metal. When fastening to the floor or wall, be sure that screws do not penetrate electrical wiring or plumbing.

A. Locate the Bracket Using the Template - (Bracket may be located on either the left or right side of the range. Use the information below to locate the bracket if template is not available). Mark the floor or wall where left or right side of the range will be located. If rear of range is against the wall or no further than 1-1/4" from wall when installed, you may use the wall or floor mount method. If molding is installed and does not allow the bracket to fit flush against the wall, remove molding or mount bracket to the floor. For wall mount, locate the bracket by placing the back edge of the template against the rear wall and the side edge of template on the mark made referencing the side of the range. Place bracket on top of template and mark location of the screw holes in wall. If rear of range is further than 1-1/4" from the wall when installed, attach bracket to the floor. For floor mount, locate the bracket by placing back edge of the template where the rear of the range will be located. Mark the location of the screw holes shown in template.

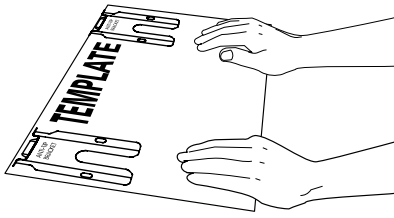

B. Drill Pilot Holes and Fasten Bracket - Drill a 1/8" pilot hole where screws are to be located. If bracket is to be mounted to the wall, drill pilot hole at an approximate 20° downward angle. If bracket is to be mounted to masonry or ceramic floors, drill a 5/32" pilot hole 1-3/4" deep. The screws provided may be used in wood or concrete material. Use a 5/16" nut-driver or flat head screwdriver to secure the bracket in place.

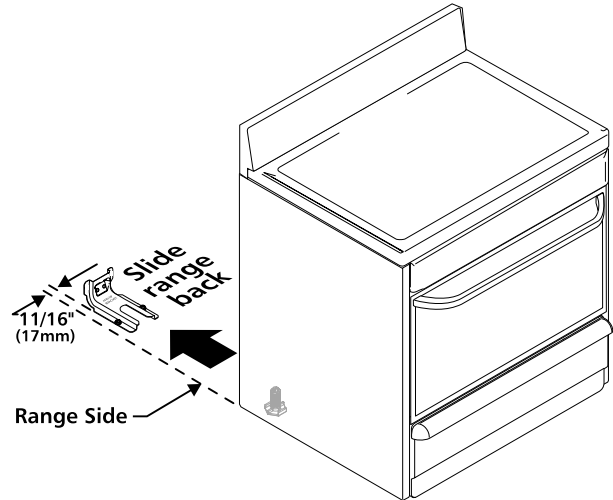

FASTEN BRACKET (WALL OR FLOOR MOUNTING)

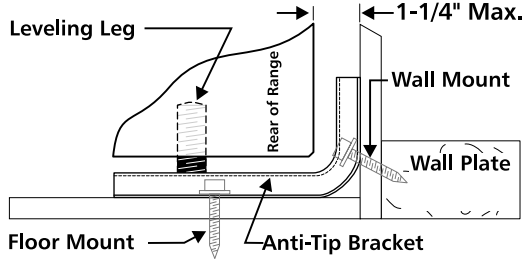

FASTEN BRACKET (FLOOR MOUNTING ONLY)

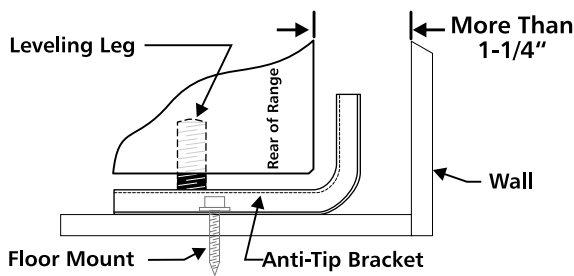

Level and Position Range - Level range by adjusting the (4) leveling legs with a wrench. Note: A minimum clearance of 1/8" is required between the bottom of the range and the leveling leg to allow room for the bracket. Use a spirit level to check your adjustments. Slide range back into position. Visually check that rear leveling leg is inserted into and fully secured by the Anti-Tip Bracket by removing lower panel or storage drawer. For models with a warmer drawer or broiler compartment, grasp the top rear edge of the range and carefully attempt to tilt it forward.

SECTION A - 40" ELECTRIC FREESTANDING INSTALLATION INSTRUCTIONS

INSTALLATION AND SERVICE MUST BE PERFORMED BY A QUALIFIED INSTALLER.

IMPORTANT: SAVE FOR LOCAL ELECTRICAL INSPECTOR'S USE. READ AND SAVE THESE INSTRUCTIONS FOR FUTURE REFERENCE.

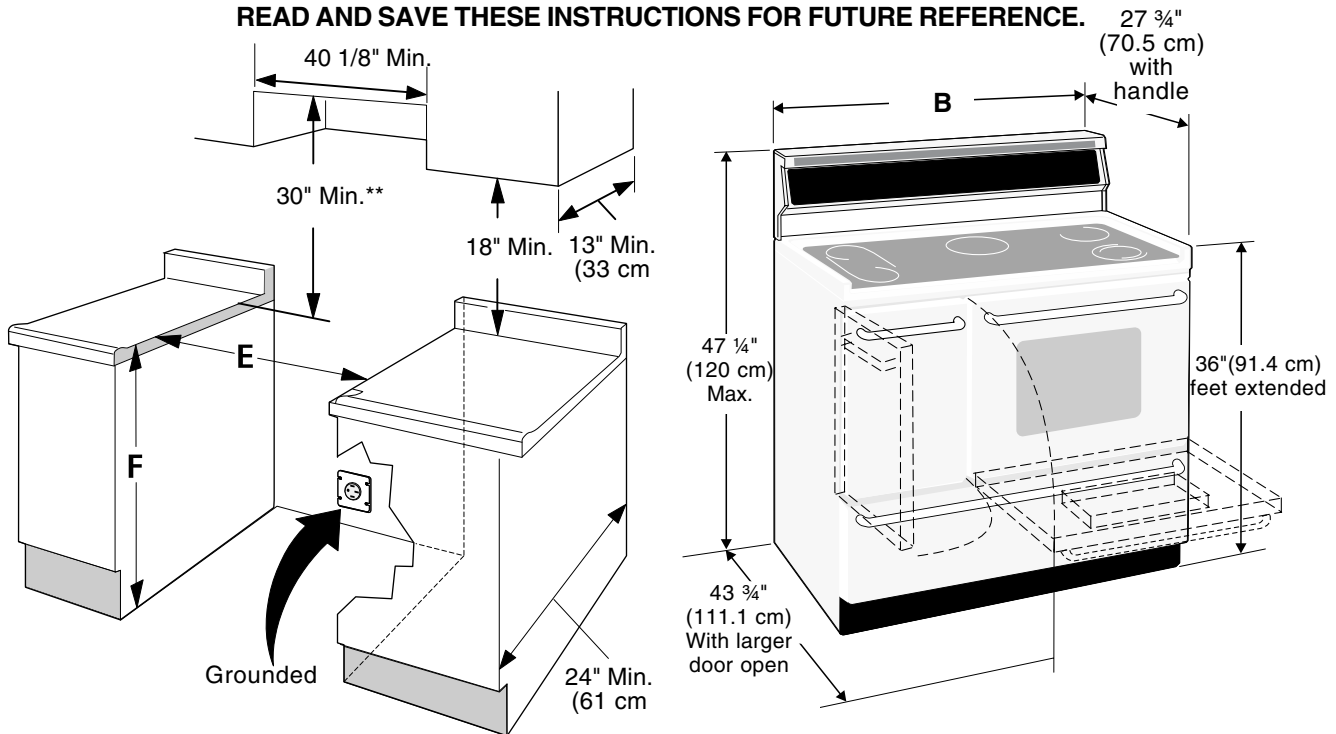

Do not pinch the power supply cord between the range and the wall.

Do not seal the range to the side cabinets.

****NOTE:** 24" (61 cm) minimum clearance between the cooktop and the bottom of the cabinet when the bottom of wood or metal cabinet is protected by not less than 1/4" (0.64 cm) flame retardant millboard covered with not less than No. 28 MSG sheet metal, 0.015" (0.4 mm) stainless steel, 0.024" (0.6 mm) aluminum, or 0.020" (0.5 mm) copper.

30" (76.2 cm) minimum clearance when the cabinet is unprotected.

A. HEIGHT	B. WIDTH	C. DEPTH TO FRONT OF RANGE
36" (91.4 cm)	40 1/8" (101.9 cm)	25 1/2" (64.8 cm)

D. DEPTH WITH DOOR OPEN	E. MINIMUM CUTOUT WIDTH	F. HEIGHT OF COUNTERTOP
43 3/4" (111.1 cm)	40 1/4" (102.2 cm)	36" (91.4 cm) standard 35 3/8" (90 cm) min.

Important Notes to the Installer

1. Read all instructions contained in these installation instructions before installing range.
2. Remove all packing material from the oven compartments before connecting the electrical supply to the range.
3. Install the 4 shipping bolts from range packaging as range leveling legs.
4. Two anti-tip brackets **MUST** be removed from lower back of range and **MUST** be installed.
5. Observe all governing codes and ordinances.
6. Be sure to leave these instructions with the consumer.

Important Note to the Consumer

Keep these instructions with your owner's guide for future reference.

IMPORTANT SAFETY INSTRUCTIONS

- **Be sure your range is installed and grounded properly by a qualified installer or service technician.**
- **This range must be electrically grounded in accordance with local codes or, in their absence, with the National Electrical Code ANSI/NFPA No. 70—latest edition.**

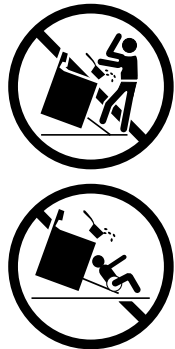
	⚠ WARNING	⚠ WARNING
	<ul style="list-style-type: none"> • All ranges can tip. • Injury to persons could result. • Install anti-tip device packed with range. 	<p>To reduce the risk of tipping of the range, the range must be secured by properly installed anti-tip bracket (s) provided with the range. To check if the bracket (s) is installed properly, remove the lower panel or storage drawer and verify that the anti-tip bracket (s) is engaged.</p>

- The installation of appliances designed for manufactured (mobile) home installation must

conform with Manufactured Home Construction and Safety Standard, title 24CFR, part 3280 [Formerly the Federal Standard for Mobile Home Construction and Safety, title 24, HUD (part 280)] or when such standard is not applicable, the Standard for Manufactured Home Installation 1982 (Manufactured Home Sites, Communities and Setups), ANSI Z225.1/NFPA 501A-latest edition, or with local codes.

- **Make sure the wall coverings around the range can withstand the heat generated by the range.**
- **Before installing the range in an area covered with linoleum or any other synthetic floor covering, make sure the floor covering can withstand heat at least 90°F/32°C above room temperature without shrinking, warping or discoloring.** Do not install the range over carpeting unless you place an insulating pad or sheet of 1/4" (6.4 mm) thick plywood between the range and carpeting.
- **Do not obstruct the flow of combustion air at the oven vent nor around the base or beneath the lower front panel of the range.** Avoid touching the vent openings or nearby surfaces as they may become hot while the oven is in operation. This range requires fresh air for proper burner combustion.

⚠ WARNING Never leave children alone or unattended in the area where an appliance is in use. As children grow, teach them the proper, safe use of all appliances. Never leave the oven door open when the range is unattended.

⚠ WARNING Stepping, leaning or sitting on the door(s) or drawer of this range can result in serious injuries and can also cause damage to the range.

- **Do not store items of interest to children in the cabinets above the range.** Children could be seriously burned climbing on the range to reach items.
- **To eliminate the need to reach over the surface units, cabinet storage space above the units should be avoided.**
- **Do not use the oven as a storage space.** This creates a potentially hazardous situation.

- **Never use your range for warming or heating the room.** Prolonged use of the range without adequate ventilation can be dangerous.
- **Do not store or use gasoline or other flammable vapors and liquids near this or any other appliance.** Explosions or fires could result.
- **Reset all controls to the "off" position after using a programmable timing operation.**

FOR MODELS WITH SELF-CLEAN FEATURE:

- **Remove broiler pan, food and other utensils before self-cleaning the oven.** Wipe up excess spillage. Follow the precleaning instructions in the Owner's Guide.

Power Supply Cord Kit

The user is responsible for connecting the power supply cord to the connection block located behind the back panel access cover.

This appliance may be connected by means of permanent "hard wiring" (flexible armored or nonmetallic shielded copper cable), or by means of a power supply cord kit. Use only a power supply cord kit rated at 125/250 volts minimum, 40 amperes minimum and marked for use with ranges. See chart (below) for cord kit connection opening size and rating information. Cord must have either 3 or 4 conductors.

For mobile home installation or areas where local codes do not permit grounding through neutral, a 4 conductor power supply cord kit rated at 125/250 volts minimum, 40 amperes minimum and marked for use with ranges should be used (see Figure 4).

Terminals on end of wires must either be closed loop or open-end spade lugs with upturned ends. Cord must have strain relief clamp.

Range Connection Opening Size Chart				
Refer to chart below for proper range connection opening size and power supply cord kit ampere rating information. See serial plate on range for kilowatt rating data.				
Range Kilowatt Rating (See Serial Plate on Range)		Minimum Cord kit Ampere Rating	Diameter (inches) of Range Connection Opening	
120/240 Volts	120/208 Volts		Cord Kit	Direct Connection
0 -16.5 kW 16.6-22.5 kW	0 -12.5 kW 12.6-18.5 kW	40 Amp 50 Amp	1-3/8 in. 1-3/8 in.	1-1/8 in. 1-3/8 in.

⚠ WARNING Risk of fire or electrical shock exists if an incorrect size range cord kit is used, if the Installation Instructions are not followed, or if the strain relief bracket is discarded.

NOTE: Range is shipped from factory with 1 1/8" dia. hole as shown in figure 3. If a larger hole is required, punch out the knockout.

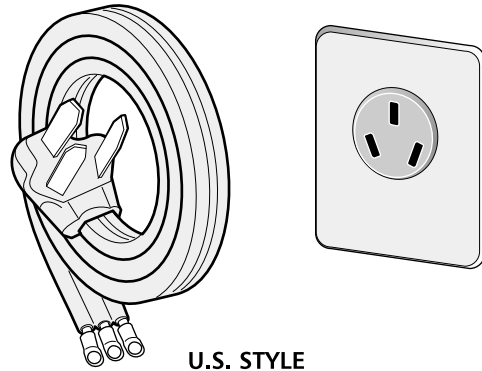

U.S. STYLE

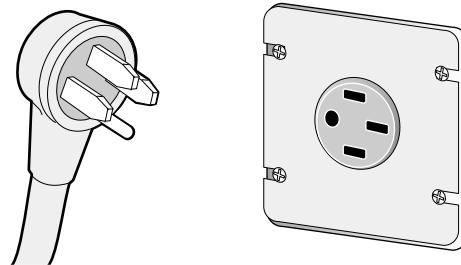

CANADIAN STYLE

Figure 1

Electrical Connection to the Range

This appliance is manufactured with the neutral terminal connected to the range.

⚠ CAUTION While connecting range, do not loosen the nuts which secure the terminal block to the range. Electrical failure or loss of electrical connection may occur.

⚠ WARNING Electrical Shock Hazard

- **Electrical ground is required on this appliance.**
- **Do not connect to the electrical supply until appliance is permanently grounded.**
- **Disconnect power to the circuit breaker or fuse box before making the electrical connection.**

- This appliance must be connected to a grounded, metallic, permanent wiring system, or a grounding connector should be connected to the grounding terminal or wire lead on the appliance.
- Do not use the gas supply line for grounding the appliance.

Failure to do any of the above could result in a fire, personal injury or electrical shock.

Three Conductor Wire Connection to Range

If local codes permit connection of the frame grounding conductor to the neutral wire of the copper power supply cord (see Figure 3):

1. Remove the 3 screws at the lower end of the rear wire cover, then bend the lower end of the rear wire cover (access cover) upward to expose range terminal connection block (see Figure 2).

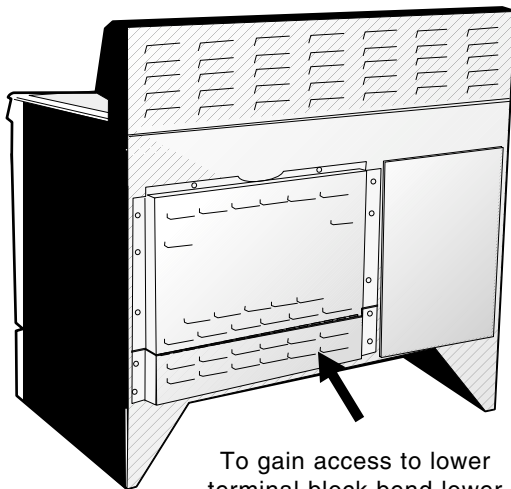

Figure 2

2. Remove the 3 loose nuts (after you removed the rubber band) on the terminal block using 3/8" nut driver or socket.
3. Connect the neutral white wire of the copper power supply cord to the center silver-colored terminal of the terminal block, and connect the other wires to the outer terminals. Match wires and terminals by color (red wires connected to the right terminal, black wires connected to the left terminal).
4. Replace the 3 nuts on the terminal block (see figure 3).

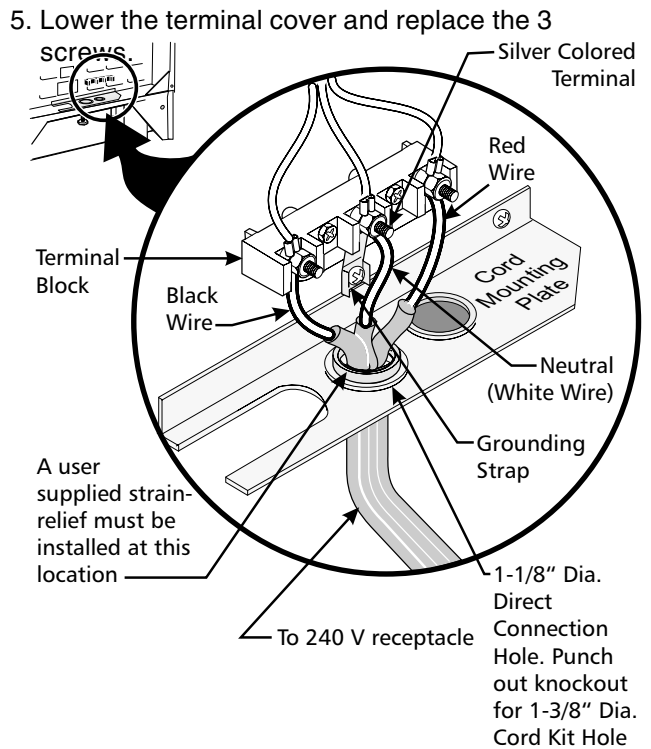

Figure 3

Four Conductor Wire Connection to Range (mobile homes)

1. Remove the 3 screws at the lower end of the rear wire cover, then raise the lower end of the rear wire cover (access cover) upward to expose range terminal connection block (see figure 2).
2. Remove the three loose nuts (after you removed the rubber band) on the terminal block using a 3/8" nut driver or socket.
3. Remove the grounding strap from the terminal block and from the appliance frame.
4. Connect the ground wire (green) of the copper power supply cord to the frame of the appliance with the ground screw, using the hole in the frame where ground strap was removed (see figure 4).
5. Connect the neutral of the copper power supply cord to the center silver-colored terminal of the terminal block, and connect the other wires to the outer terminals. Match wires and terminals by color (red wires connected to the right terminal, black wires connected to the left terminal).
6. Replace the 3 nuts on terminal block (see figure 4).
7. Lower the terminal cover and replace the 3 screws.

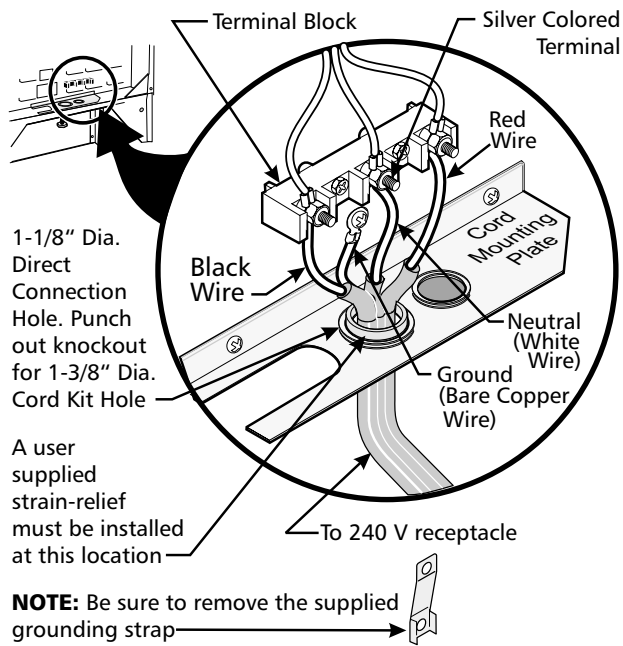

Figure 4

Direct Electrical Connection to the Circuit Breaker, Fuse Box or Junction Box

If the appliance is connected directly to the circuit breaker, fuse box or junction box, use flexible, armored or non metallic sheathed copper cable (with grounding wire). Supply a U.L. listed strain-relief at each end of the cable. At the appliance end, the cable goes through the Direct Connection Hole (see figure 4) on the Cord Mounting Plate. Wire sizes (**copper wire only**) and connections must conform to the rating of the appliance.

Where local codes permit connecting the appliance grounding conductor to the neutral (white) wire (see Figure 5).

1. Disconnect the power supply.
2. In the circuit breaker, fuse box or junction box:
 - a) Connect the green (or bare copper) wire, the white appliance cable wire, and the neutral (white) wire together.
 - b) Connect the 2 black wires together.
 - c) Connect the 2 red wires together.

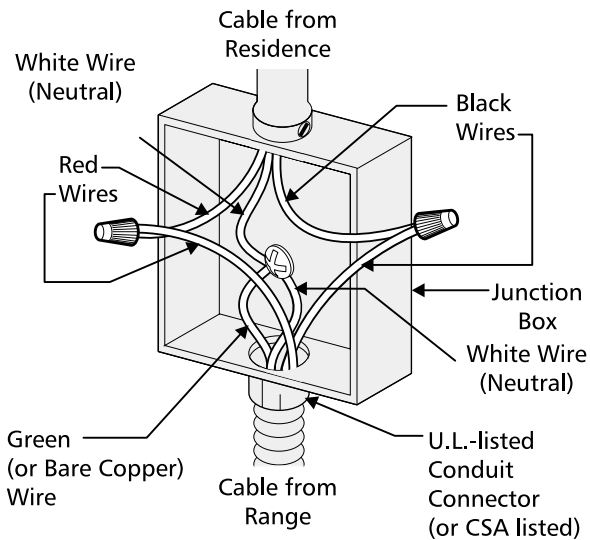

Figure 5
3-Wire (Grounded Neutral) Electrical System
(example: Junction Box)

Where local codes **DO NOT** permit connecting the appliance grounding conductor to the neutral (white) wire or if connecting to 4-wire electrical system (see Figure 6).

1. Disconnect the power supply.
2. Separate the green (or bare copper) and white appliance cable wires.
3. In the circuit breaker, fuse box or junction box:
 - a) Connect the white appliance cable wire to the neutral (white) wire.
 - b) Connect the 2 black wires together.
 - c) Connect the 2 red wires together.
 - d) Connect the green (or bare copper) grounding wire to the grounding wire of the circuit breaker, fuse box or junction box.

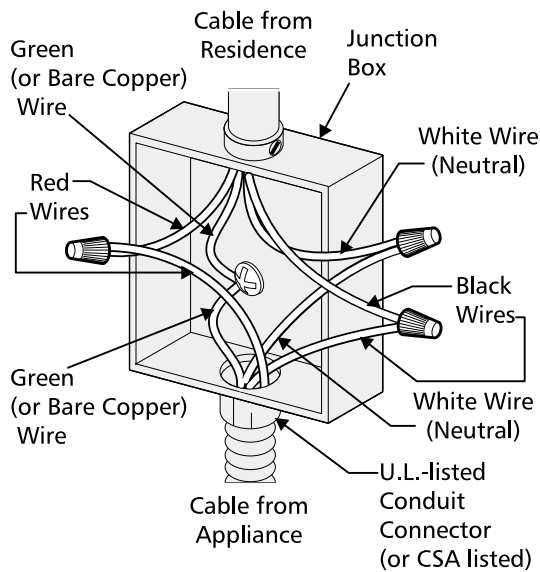

Figure 6
4-Wire Electrical System
(example: Junction Box)

Junction Box Location

Locate junction box as shown in Figure 7.

If a service cord is used, the wall receptacle should be located in accordance with the dimensions below.

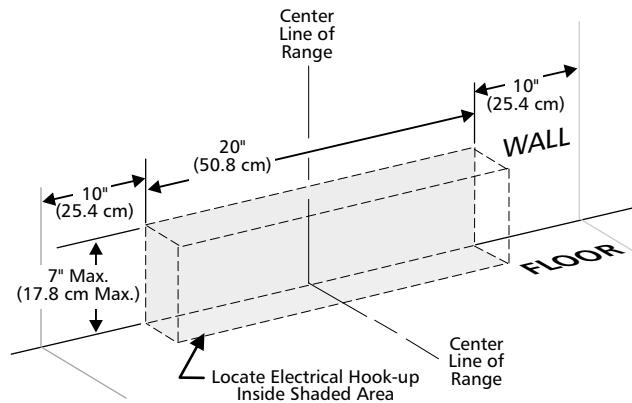

Figure 7

Range Placement

CAUTION To eliminate the risk of burns or fire by reaching over heated surface units, cabinet storage space located above the range should be avoided. If cabinet storage space is to be provided, the risk can be reduced by installing a range hood that projects horizontally a minimum of 5" (12.7 cm) beyond the bottom of the cabinet.

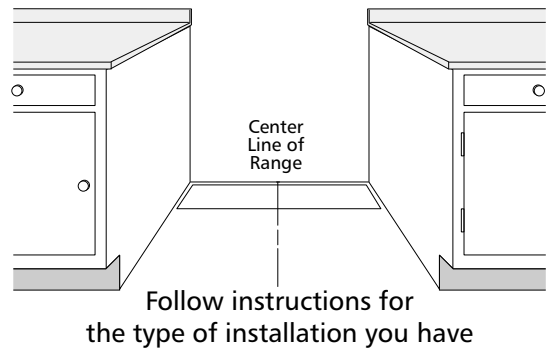

Figure 8

If range will be installed with a cabinet on both sides, draw a center line on the floor between the cabinets (see figure 8). **If back of range will not be flush with the wall** (the location of the outlet may not allow the range to be positioned against the wall), draw a line on the floor where the back edge of the range will be. Now install anti-tip brackets.

If range will be installed with a cabinet on one side only, move the range into final position. Draw a line on the floor along the side of the range that is not against the cabinet. **If back of range will not be flush with the wall** (the location of the outlet may not allow the range to be positioned against the wall), draw a line on the floor where the back edge of the range will be. Now install anti-tip brackets (see "Anti-Tip Brackets Installation").

If range will not be installed against a cabinet, move range into final position. Mark on the floor along both sides of the range. **If back of range will not be flush with the wall** (the location of the outlet may not allow the range to be positioned against the wall), draw a line on the floor where the back edge of the range will be. Now install anti-tip brackets.

Range Installation

CAUTION When unpacking the range, do not discard the 4 shipping bolts. These are to be replaced on the unit for use as leveling legs and height adjustments.

1. The back of the range may be installed directly against the rear wall of the structure.
2. These ranges conform to U.L. requirements for "0" spacing from the range to adjacent vertical walls above the countertop level. However, to reduce possible scorching of vertical walls and to minimize potential fire hazards under abnormal surface unit use conditions such as

high heat or no pans, a minimum of 2" (5.1 cm) spacing should be provided on both sides of the cooktop.

Preparation

⚠ WARNING Excessive Weight Hazard

- Use 2 or more people to move and install range.
- Failure to follow this instruction can result in back or other injury.

1. Put on safety glasses and gloves. Remove oven racks and parts package from inside the oven. Remove shipping materials, tape and protective film from the range.
2. Take 4 cardboard corners from the carton. Stack one on top of another. Repeat with other 2 corners. Place corners lengthwise on the floor in back of the range to support range.
3. Firmly grasp the range and gently lay it on its back on the cardboard corners.
4. Remove and save the 4 shipping bolts from the skid. Discard skid.
5. Install 4 shipping bolts as leveling legs.
6. Lay a large piece of cardboard in front of the range. Carefully stand the range upright on cardboard.
7. Adjust the leveling legs to a point where the range base does not touch the floor.

Leveling the Range

Level the range and set cooktop height before installation in the cut-out opening (if applicable).

1. Install an oven rack in the center of the oven.
2. Place a level on the rack (see figure 9). Take 2 readings with the level placed diagonally in one direction and then the other. Level the range, if necessary, by adjusting the 4 leg levelers with a wrench (see Figure 11).
3. Slide range into cut-out opening and double check for levelness. If the range is not level, pull unit out and readjust leveling legs, or make sure floor is level.

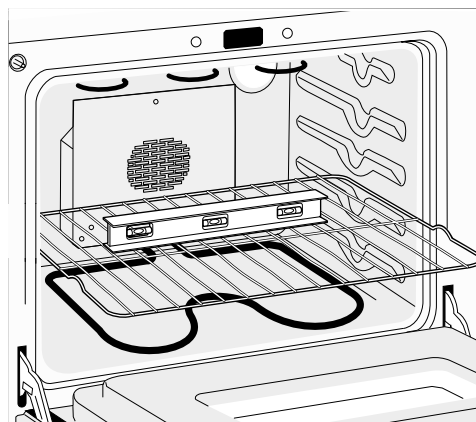

Figure 9

Check Operation

Refer to the Owner's Guide packaged with the range for operating instructions and for care and cleaning of your range.

⚠ CAUTION Do not touch the elements. They may be hot enough to cause burns.

Remove all packaging from the oven before testing.

1. Operation of Surface Elements

Turn on each of the four surface elements and check to see that they heat. Check the surface element indicator light(s), if equipped.

2. Operation of Oven Elements

The oven is equipped with an electronic oven control. Each of the functions has been factory checked before shipping. However, it is suggested that you verify the operation of the electronic oven controls once more. Refer to the Owner's Guide for operation. Follow the instructions for the Clock, Timer, Bake, Broil, Convection (some models) and Clean (some models) functions.

Bake—After setting the oven to 350°F (177°C) for baking, the lower element in the oven should become red.

Broil—When the oven is set to BROIL, the upper element in the oven should become red.

Clean (some models)—When the oven is set for a self-cleaning cycle, the upper element should become red during the preheat portion of the cycle. After reaching the self-cleaning temperature, the lower element will become red.

Convection (some models)—When the oven is set to CONV. BAKE/ROAST at 350°F (177°C), both elements cycle on and off alternately and the convection fan will turn. The convection fan will stop turning when the oven door is opened during convection baking or roasting.

When All Hookups are Complete

Make sure all controls are left in the OFF position.

Model and Serial Number Location

The serial plate is located on the oven front frame behind the large oven door.

When ordering parts for or making inquiries about your range, always be sure to include the model and serial numbers and a lot number or letter from the serial plate on your range.

Before You Call for Service

Read the Avoid Service Checklist and operating instructions in your Owner's Guide. It may save you time and expense. The list includes common occurrences that are not the result of defective workmanship or materials in this appliance.

Refer to the warranty and service information in your Owner's Guide for our phone number and address. Please call or write if you have inquiries about your range product and/or need to order parts.

Important Safety Warning

To reduce the risk of tipping of the range, the range must be secured to the floor by properly installed anti-tip brackets and screws packed with the range. Those parts are located in a plastic bag in the oven. Failure to install the anti-tip brackets will allow the range to tip over if excessive weight is placed on an open door or if a child climbs upon it. Serious injury might result from spilled hot liquids or from the range itself.

Follow the instructions below to install the anti-tip brackets.

If range is ever moved to a different location, the anti-tip brackets must also be moved and installed with the range. To check for proper installation, see step 5.

Tools Required:

- Adjustable wrench or channel lock pliers



- 5/16" Nutdriver or Flat Head Screwdriver



- Electric Drill & 1/8" Diameter Drill Bit (Masonry Drill Bit if installing in concrete)



Anti-Tip Brackets Installation Instructions

Brackets attach to the floor at the back of the range to hold both rear leg levelers. When fastening to the floor, be sure that screws do not penetrate electrical wiring or plumbing. The screws provided will work in either wood or concrete.

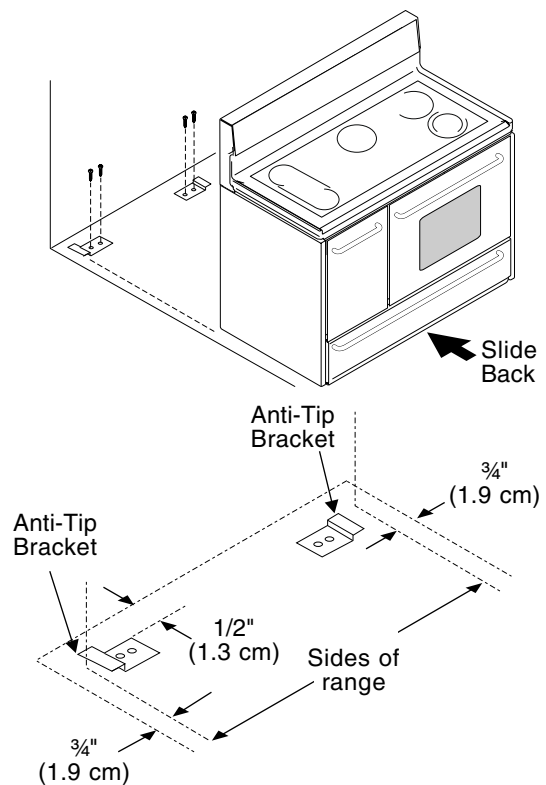

Figure 10

1. Unfold paper template and place it flat on the floor with the back and side edges positioned exactly where the back and sides of range will be located when installed. (Use the diagram in figure 10 to locate brackets if template is not available.)
2. Mark on the floor the location of the 4 mounting holes (2 holes per bracket) shown on the template. For easier installation, 3/16" (4.8 mm) diameter pilot holes 1/2" (1.3 cm) deep can be drilled into the floor.

3. Remove template and place brackets on floor with turned up flanges to the outside (see figure 10). Line up holes in brackets with marks on floor and attach with 4 screws provided (2 screws per bracket). Brackets must be secured to solid floor. If attaching to concrete floor, first drill 3/16" (4.8 mm) dia. pilot holes using a masonry drill bit.
4. Level range if necessary, by adjusting 4 leg levelers with wrench. (See Figure 11). A minimum clearance of 1/8" (3.2 mm) is required between the bottom of the range and the rear leg levelers to allow room for the anti-tip brackets.
5. Slide range into place making sure rear legs are trapped by ends of brackets. Range may need to be shifted slightly to one side as it is being pushed back to allow rear legs to align with brackets.
6. After installation, verify that the anti-tip bracket is engaged. Open and remove drawer and check to make sure the anti-tip bracket is engaged.

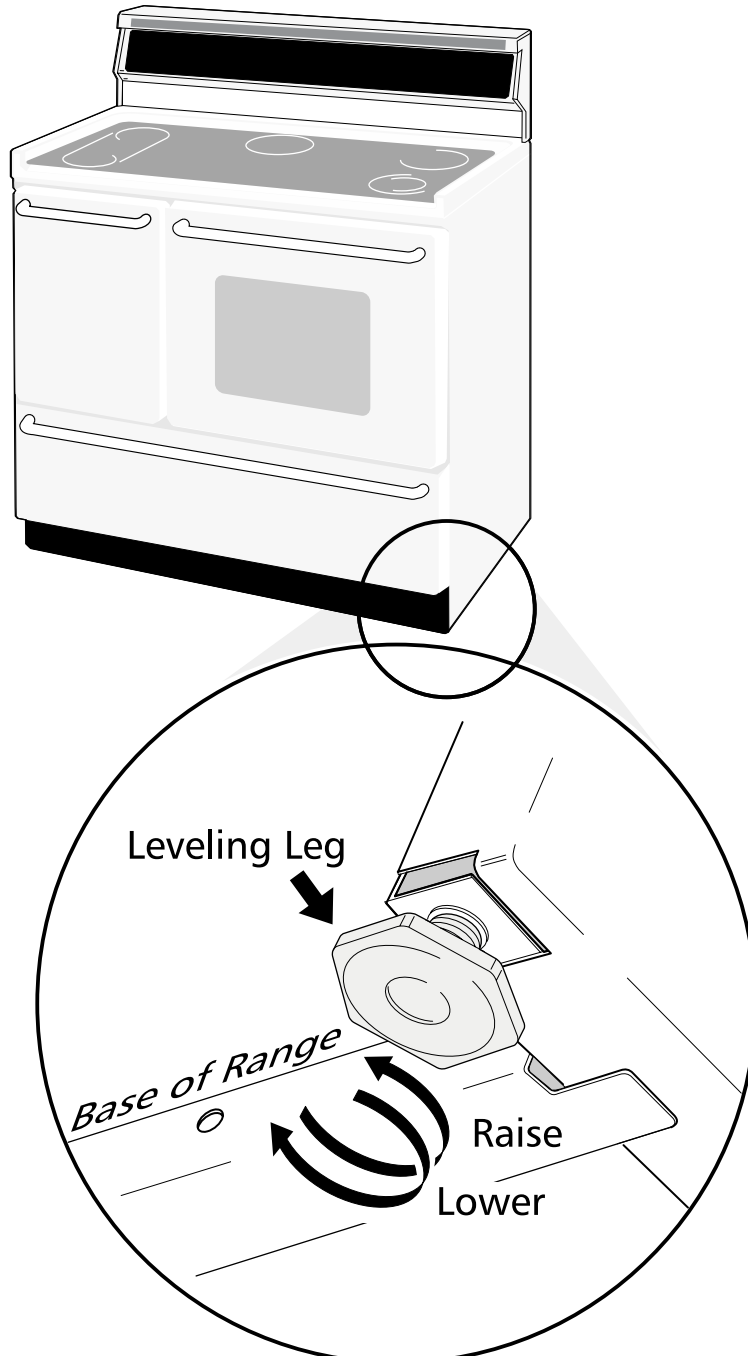
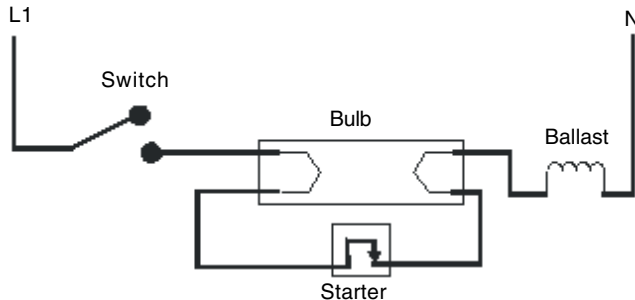

Figure 11

SECTION B - ACCESSORIES

Fluorescent lamp:

The fluorescent lamp circuit located in the backguard is made up of a switch, starter, ballast and a fluorescent light bulb.



How the fluorescent lamp circuits operates:

When the contacts of the switch are closed power is applied to one of the filaments of the light bulb. The filaments of the lamp are connected by the contacts of the starter. When current starts to flow the open contacts of the starter close. This means the filaments are connected in series with the circuit that is completed to neutral through the winding of the ballast. The first few seconds after the switch is closed current flows through the filaments, starter and ballast. After a few seconds of current flow three things happen. The filaments are heated so they can emit electrons, the contacts of the starter open and the windings of the ballast builds a magnet field. When the starter contacts open, current in the circuit is momentarily interrupted. When the current is interrupted the magnet field around the windings of the ballast collapse inducing around 180 volts into the circuit. This breaks down the dielectric of the light bulb allowing electrons to flow between the filaments causing the light to glow. With current again flowing in the circuit the windings of the ballast place impedance in the circuit lowering the current flow in the circuit to make it more efficient.

Troubleshooting the fluorescent lamp circuit

Two common failures that occur in a fluorescent lamp circuit are:

The light bulb flickers or only glows at the ends:

1. This is usually caused by either a defective bulb or starter. To determine which part is defective close the switch and allow the light to act up. Then remove the starter. If this corrects the problem the starter is defective, If the problem is not corrected change the light bulb.

Light bulb does not glow:

1. Remove the light bulb and check the continuity of the filaments. If either of the filaments are open replace the light bulb. If the filaments check good, go to step 2.
2. With the switch turned on measure the voltage drop between each terminal of the switch and neutral. If the meter reads zero from both terminals the wire between the L1 terminal block and switch is open. If the measurement from one terminal reads 120 VAC and the other reads zero the switch is defective. If the meter reads 120 VAC from both terminals go to step 3.
3. Disconnect electrical power from the range and reinstall the bulb. Remove the starter and drop the starter socket down so that a meter probe can be inserted into the terminals. Measure the resistance between the output terminal of the switch and the terminal in the starter socket that is connected to the filament that is connected to the switch. If the meter reads open the light socket, the starter socket or the wires between the two are open. If the meter reads zero go to step 4.
4. Measure the resistance between neutral and the terminal in the starter socket that is connected to the filament that is connected to the ballast. If the meter reads open, the ballast, the light socket, or the wiring between them is defective. If the meter reads around 22 ohms replace the starter. If the meter reads zero the ballast is shorted or a wire is pinched to chassis.

120 volt outlet:

Some model ranges sold in Canada are equipped with a 120 volt convenience outlet. To protect the wiring in the range from products being plugged into this outlet, a 15 amp fuse is installed in the circuit before the outlet. If voltage is not present at the outlet check the fuse and the outlet.

SECTION C - SURFACE ELEMENT CONTROL SYSTEMS

Three types of surface element control systems are covered in this manual.

1. Standard infinite switch.
2. Dual infinite switch.
3. Electronic top element system. (ESEC 5)

Standard infinite switch:

The surface elements and standard infinite switches provide an infinite choice of heat settings for cooking. Controls are safety type and must be pushed in before turning. All surface controls are marked on the control panel for their respective heating element. Power is supplied to the surface elements through the infinite switch contacts L1 - H1 and L2 - H2. During actual surface element operation, if the control is set to the high position contacts L2 - H2 are lock closed providing continuous power to the element. In all other settings contacts L2 - H2 will cycle to maintain the correct heat setting. Contacts L1 - P provide power to the surface element indicator light.

Troubleshooting:

There are four ways a surface control system with a standard infinite switch can fail.

1. The element does not heat.
2. The switch does not cycle the element off and on when set to a position other than high.
3. The element operates correctly, but the indicator light does not glow.
4. Indicator light glows with all infinite switches in the off position.

NOTE: If the indicator light glows very dimly with all the switches in the off position. This problem is caused by a capacitive feed over in the wiring and can be corrected by connecting a 100,000 Ohm 1/4 watt resistor in parallel with the light.

Continuity tests can be performed on the infinite switch contacts. All tests should be performed with power to the range disconnected, and wiring removed from the switch. Set an ohmmeter on R X 1K scale and check the contacts in the following chart and switch terminal diagram.

Contact	Dial Position		
	OFF	LO-MED	HI
L1 - P	O	X	X
L1 - H1	O	X	X
L2 - H2	O	X - C	X

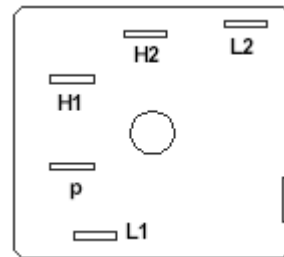

Element does not heat:

Checking the system with a Voltmeter, if the element does not heat up.

1. Disconnect power, roll the control panel forward to expose the switch terminals and reconnect power.
2. With a Voltmeter set for AC on a scale higher than 240 Volts, measure the voltage drop between terminals L1 and L2. If the meter reads zero the wiring between the main terminal block on the range and the switch is open. If the meter reads line to line voltage (around 240 VAC) go to step 3.
3. With the switch turned to the high position measure the voltage drop between terminals H1 and H2. If the meter reads zero the switch is defective. If the meter reads line to line voltage the switch is good. If the range has standard elements go to step 4. If the range has a glass smooth top go to step 5.

Note: Some models with a large left rear coil element have a safety thermostat in series with the left rear element. If 240 VAC is read between H1 & H2 and the element does not heat check the wiring diagram to see if this model is equipped with a safety thermostat. If it is, set the switch on high and measure voltage drop across the terminals of the safety thermostat. If the meter reads 240 VAC reset or if necessary replace the thermostat. If the meter reads zero, check between the terminals of the terminal block. If the meter reads zero the terminal block or the wiring between the switch and the terminal block is open. If the meter reads line to line voltage the element is defective

NOTE: Always inspect the terminal block for burnt spots that can cause a poor connection.

5. Raise the top and locate the two terminals on the element that the wires from H1 and H2 are on. Measure the voltage drop between the two terminals. If the meter reads zero the wires between the switch and the element are open. If the meter reads line to line voltage the element is defective.

Element does not cycle:

If the element does not cycle when the switch is set in a position other than high, the switch is defective.

Indicator light does not glow:

If indicator light does not glow when the switch is turned on, remove the back panel of the backguard, turn the switch on, and measure the voltage drop between terminals P and L2. If the meter reads zero the switch is defective. If the meter reads line to line voltage (around 240 VAC) the light or the wiring to the light is defective.

Indicator light glows full brilliance with all top element switches off:

If indicator light glows full brilliance with all top element switches off, one or more of the switches are defective. Disconnect electrical power from the range, and remove the back panel of the backguard. Disconnect the wire from the P terminal on all switches but one switch. Reconnect power. If the indicator light glows with the switch in the off position, the switch is defective. If the indicator light does not glow, the switch is good. Check each switch by disconnecting the wires from all the other P terminals except the switch you are testing.

Dual infinite switch:

The dual infinite switch is used to control the expandable and bridge elements on electric smooth top ranges. The dual infinite switch provides an infinite choice of heat settings for cooking, and two selections of element sizes. Controls are safety type and must be pushed in before

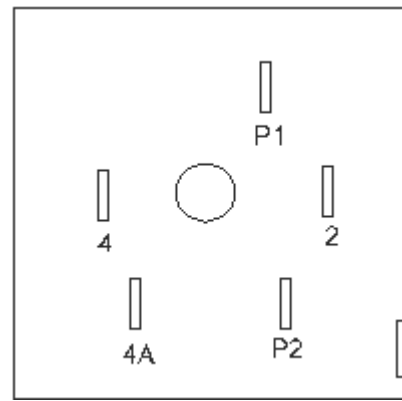
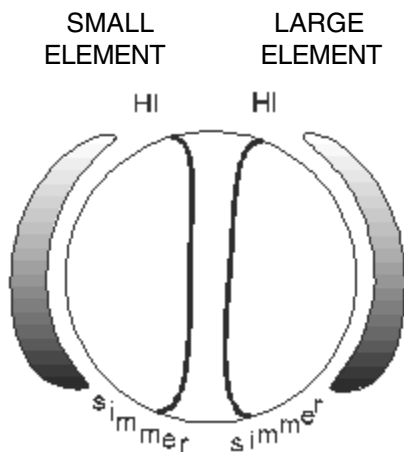

turning. All surface controls are marked on the control panel for their respective heating element. When the knob is turned clockwise, less than 180 degrees, contacts P2 to 4, P2 to 4A, and P1 to 2 close providing power to both elements. When the knob is turned counterclockwise, less than 180 degrees, contacts P2 to 4 and P1 to 2 close providing power to the inner element. During actual surface element operation, if the control is set to the high position contacts P1-2 are lock closed providing continuous power to the element. In all other settings contacts P1 to 2 will cycle to maintain the correct heat setting. Contact 4 to L2 provides power to the surface element indicator light.

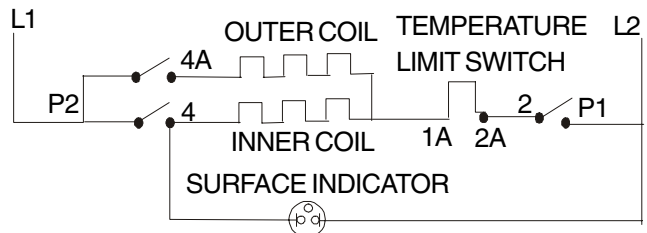

Troubleshooting:

There are six ways a surface control system with a dual infinite switch can fail.

1. Both elements do not heat.
2. The outer element does not heat.
3. The inner element does not heat.
4. The switch does not cycle the element off and on when set to a position other than high.
5. The element operates correctly, but the indicator light does not glow.
6. Indicator light glows with all the infinite switches in the off position.

NOTE: If the indicator light glows very dimly with all the switches in the off position, the problem is caused by a capacitive feed over in the wiring and can be corrected by connecting a 100,000 Ohm 1/4 watt resistor in parallel with the light.

Both elements do not heat:

Checking the system with a Voltmeter, if the elements do not heat:

1. Disconnect power, roll the control panel forward to expose the switch terminals and reconnect power.
2. With a Voltmeter set for AC and a scale higher than 240 Volts measure the voltage drop between terminals P1 and P2. If the meter reads zero the wiring between the main terminal block on the range and the switch is open. If the meter reads line to line voltage (around 240 VAC) go to step 3.
3. With the switch turned clockwise to the HI position, measure the voltage drop between terminals 2 and 4. If the meter reads zero the switch is defective. If the meter reads line to line voltage measure the voltage drop between terminals 2 and 4A. If the meter reads line to line voltage the switch is good. Go to step 4.
4. Raise the main top and locate the two terminals on the element with the wires from terminals 2 and 4 are connected. Measure the voltage drop between these two terminals. If the meter reads zero the wires between the switch and the elements are open. If the meter reads line to line voltage the element is defective.

Outer element doesn't heat, but inner element does:

Checking the system with a Voltmeter, if the outer element does not heat, but the inner element does:

1. Disconnect power, roll the control panel forward to expose the switch terminals and reconnect power.
2. With the switch turned clockwise to the HI position, measure the voltage drop between terminals 2 and 4A. If the meter reads zero the switch is defective. If the meter reads line to line voltage the switch is good. Go to step 3.
3. Raise the main top and locate the two terminals on the element where the wires from terminals 2 and 4A are connected. Measure the voltage drop between these two terminals. If the meter reads zero the wires between the switch and the elements are open. If the meter reads line to line voltage the element is defective.

Inner element doesn't heat, but outer element does:

Checking the system with a Voltmeter, if the inner element does not heat, but the outer element does:

1. Disconnect power, roll the control panel forward to expose the switch terminals and reconnect power.
2. With the switch turned clockwise to the HI position, measure the voltage drop between terminals 2 and 4. If the meter reads zero the switch is defective. If the meter reads line to line voltage the switch is good. Go to step 3.
3. Raise the main top and locate the two terminals on the element where the wires from terminals 2 and 4 are connected. Measure the voltage drop between these two terminals. If the meter reads zero the wires between the switch and the elements are open. If the meter reads line to line voltage the element is defective.

Elements do not cycle:

If the elements do not cycle when the switch is set in a position other than high the switch is defective.

Indicator light does not glow:

If the indicator light does not glow when the switch is turned on, disconnect power, roll the control panel forward, and reconnect power. Turn the switch on, and measure the voltage drop between terminal 4 and L2. If the meter reads zero the switch is defective. If the meter reads line to line voltage the light or the wiring to the light is defective.

Indicator light glows full brilliance with all top element switches off:

If the indicator light glows full brilliance with all the top elements switches off, one or more of switches are defective. Disconnect electrical power from the range, roll the control panel forward. Disconnect the wire from terminal 4 on the switches from all but one switch. Reconnect power. If the indicator light glows with the switch in the off position the switch is defective. If the indicator light does not glow the switch is good. Check each infinite switch by disconnecting the wires from all the other 4 terminals except the switch you are testing.

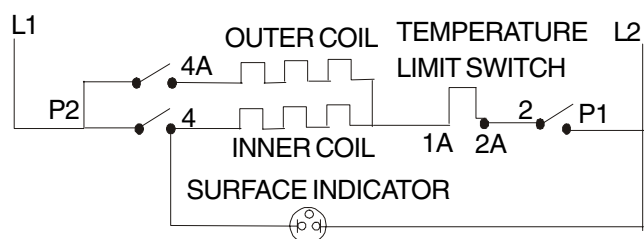

Top Element Electronic Control System:

Some electric range models are equipped with electronic top element controls, these controls are more accurate and allow for a lower simmer temperature than the conventional infinite switches.

CAUTION: ON MODELS WITH ELECTRONIC TOP ELEMENT CONTROLS, LINE 1 IS CONNECTED TO THE TOP ELEMENTS WHENEVER ELECTRICAL POWER IS APPLIED TO THE RANGE.

Components of the system:

The top element electronic control system (engineering named ESEC 5) is made up of four components; Potentiometers, User Interface Boards, Mother Board and Top Elements.

1. Four potentiometers (variable resistors) - one for each top element, that the user changes the resistance of when they turn the knob. Because of the different types of elements two different potentiometers are used. A potentiometer with a resistance of 20,000 Ohms is used with the single element, and a potentiometer with a resistance of 10,000 Ohms is used with the dual and bridge elements. The potentiometers are identified by the color of their base. The 20,000 Ohm potentiometer has a gray base, the 10,000 potentiometer has a black base.

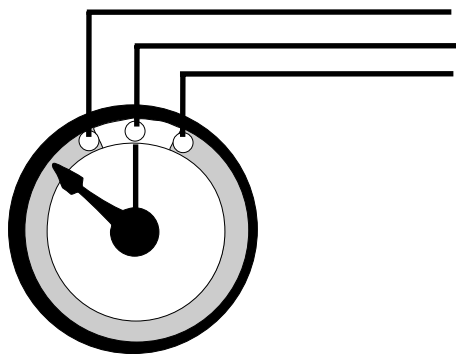

Potentiometer

2. Two user interface boards (UIB) - one for each side of the range, with four displays, one for each element that shows the setting of the control. These work as interfaces between potentiometers and the mother board.

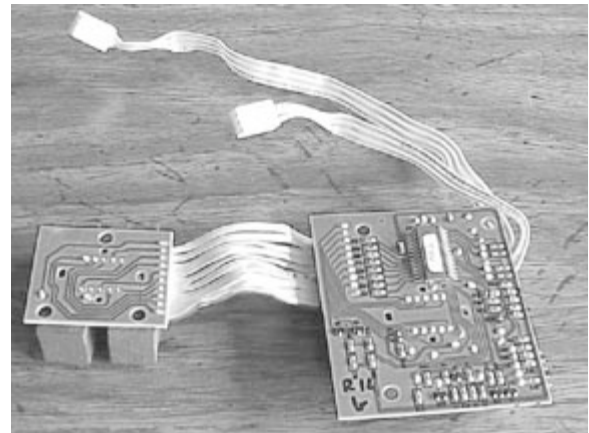

User Interface Board

3. One mother board - main circuit board that has a transformer to provide low voltage for the system, a microprocessor that controls and communicates with the other components of the system, and relays that control line to line voltage to the top elements.

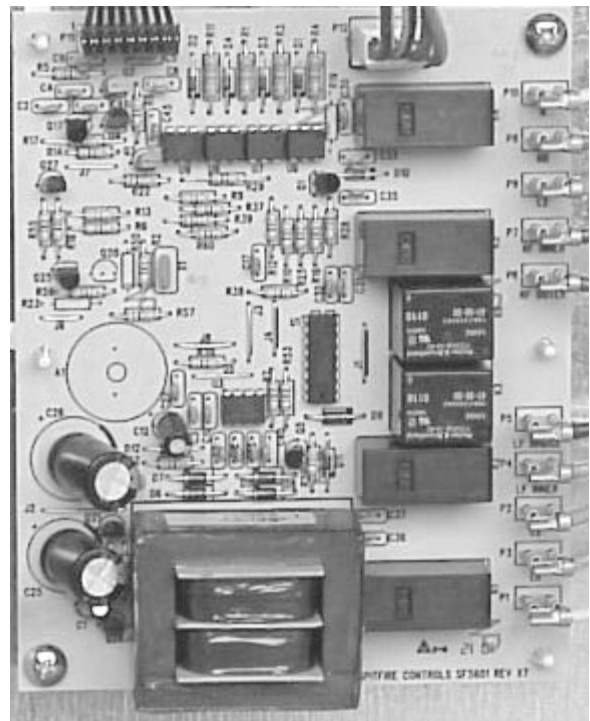

Mother Board

4. Top elements - three types are used; a single element, a dual element, and a bridge element.

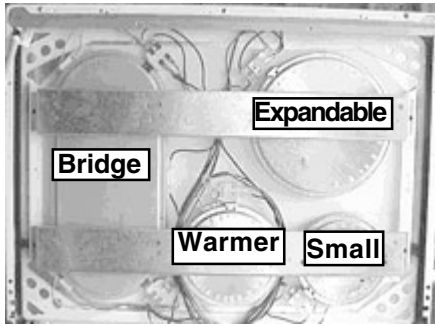

Top elements

Display Reading	% Of On Time	Display Reading	% Of On Time
Lo	1	4.0	35
1.0	2	4.5	40
1.2	3	5.0	45
1.4	4	5.5	50
1.6	5	6.0	60
1.8	6	6.5	70
2.0	8	7.0	75
2.2	10	7.5	80
2.4	12	8.0	85
2.6	15	8.5	90
2.8	20	9.0	95
3.0	25	Hi	100
3.5	30		

How it operates:

Whenever the range is connected to electrical power, low voltage from the mother board is applied across the two outside pins of the potentiometers. The microprocessor then reads the resistance of the potentiometers. When the switch knob is depressed and turned the wipe arm attached to the center pin of the potentiometer is turned to a resistance range that the microprocessor can read. The microprocessor then compares these two readings and displays the setting in the UIB display window for that element. To prevent the microprocessor from reading a short or an open, a fixed resistance is connected to each end of the adjustable resistor internally. The 10,000 Ohm potentiometer has a 500 Ohm resistance on each end of the winding and the 20,000 Ohm potentiometer has a 1,000 Ohm resistance on each end of the winding.

The setting display in the UIB display window will read from Hi to Lo with numbers in between (see following chart). The microprocessor operates on a 15 second duty cycle. When the knob is turned to the HI position the mother board applies line to line voltage to the element all the time. In any other setting other than Hi the microprocessor will cycle line to line voltage to the element by opening and closing the relay on the mother board for that element.

NOTE: On glass top ranges the element may cycle in the Hi position because of the limiter in the element that protects the glass.

NOTE: In the Lo position a 2500 watt element would be operating at 25 watts.

The display is also used as a hot surface indicator on glass top ranges. The mother board is connected to the hot surface contacts of the element's limiter. When the potentiometer is turned to the off position, if the hot surface contacts of the limiter are closed the display will read HE for hot element until the element cools down and the hot surface contacts of the limiter opens.

Troubleshooting the ESEC 5:

The ESEC 5 has some self diagnostics built into the microprocessor to help in troubleshooting the system. When a failure occurs one of three codes will appear in all the display windows: F5, F6, or F7.

F5 code: (Communication break between Mother board and UIB's)

Indicates a harness, mother board, or user interface board has failed. The harness is the first thing to check, unplug the harness, inspect each connection and Ohm out the harness.

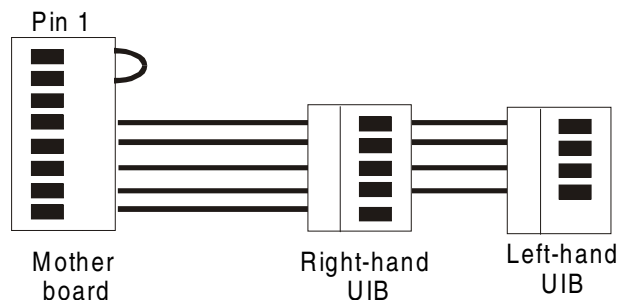

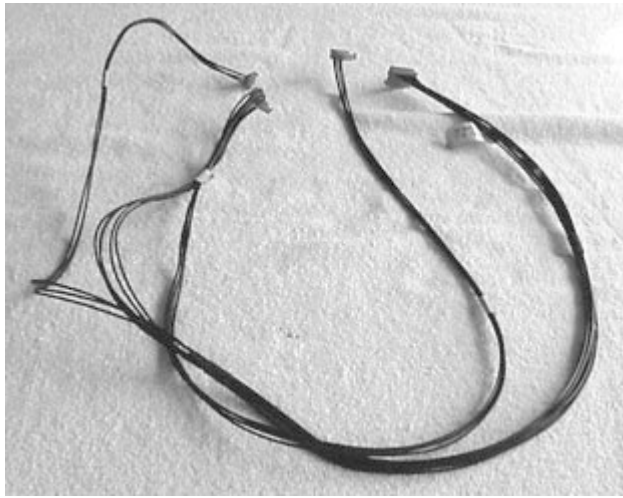

Harness

Reconnect the harness, if the F5 is still displayed, go to the righthand user interface board as viewed from the rear of the range. Notice that the harness to this board has four wires and five pins. Disconnect the harness plug from the board. With a voltmeter set to DC volts, using a scale that will measure up to sixteen volts, measure the voltage drop between pins 1 and 2.

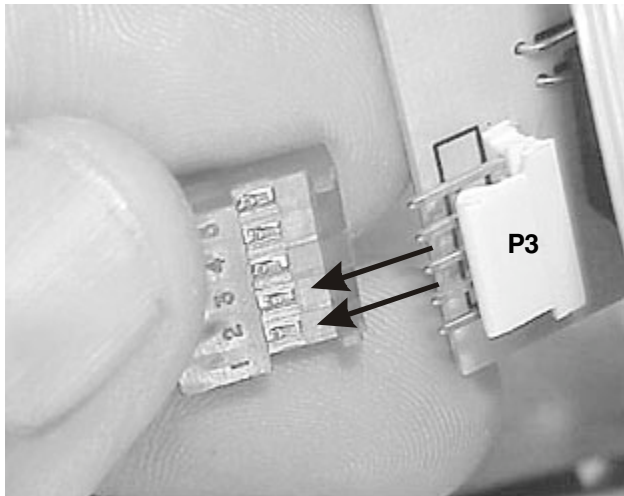

Pins 1 & 2

If the reading is between 4 VDC and 12 VDC the mother board is good. One at a time substitute a good user interface board for the ones in the range. When the F5 code disappears, that user interface board is defective. If the reading is below 4 or above 12 volts DC replace the mother board. If the F5 code still does not disappear, recheck the harness and replace each user interface boards one at a time.

F6 code:

The ESEC 5 system has a lockout feature built-in to the control that works in conjunction with certain electronic oven control to locks out the top elements when the oven is in clean or when the lock feature is set on the oven control. This feature is **not** used on ranges covered in this manual. To bypass this feature a jumper wire is connect, in the harness, between pins 1 and 2 of P11 on the mother board.

When an F6 failure code occurs this means that either the jumper wire is open or the mother board is defective. To troubleshoot this, disconnect the harness from P11 and using an Ohmmeter measure the resistance between pins 1 and 2 in the harness. If the meter reads open the harness is defective. If the meter reads zero the mother board is defective.

F7 code:

Indicates a failed potentiometer, a user interface board or the harness between the mother board and the user interface boards. To determine which has failed, check the resistance of the potentiometers. The resistance between the two outside pins should be within 10% of the potentiometer value (black 10,000 Ohms, gray 20,000 Ohms). From the center pin to an outside pin the resistance should vary between 500 and 9500 Ohms on the black and 1000 and 19,000 Ohms on the gray, as the shaft is turned.

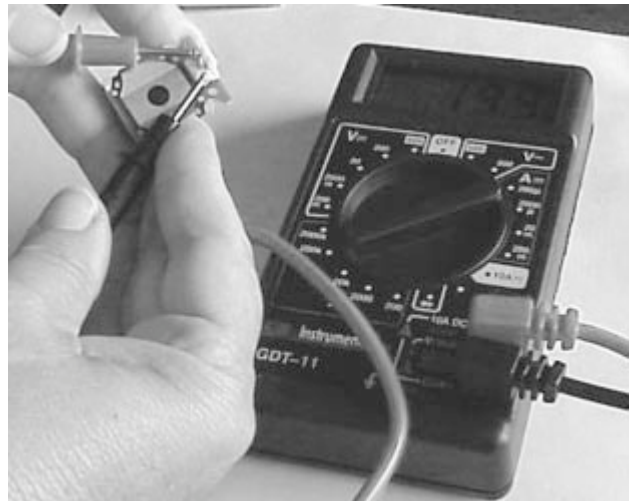

Potentiometer test

NOTE: When testing from an outside pin to the center pin the potentiometer must be turned on.

If the potentiometers test good, remove and Ohm out the harness. If the harness checks good, reinstall the harness and replace one of the user interface boards with a new or known good board. Turn one of the top elements on. If the element operates normal, replace the user interface board. If the F7 reappears, turn the top element off, reinstall the board that was replaced and replace the other user interface board. Turn one of the top elements on. If the element operates normal replace that user interface board. If the F7 still appears, recheck the harness.

Blank display:

If the display remains blank when an element is turned on, listen, if you hear a beep when the element is turned on. If the range beeps, one of the user interface board or the harness between the mother board and the user interface boards is defective. Remove and Ohm out the harness. If the harness checks good, reinstall the harness and replace one of the user interface board with a new or known good board. Turn one of the top elements on. If the element operates normal replace that user interface board. If the display remains blank, turn the top element off, reinstall the board that was replaced and replace the other user interface board. Turn one of the top elements on. If the element operates normal, replace that user interface board. If the display remains blank, recheck the harness between the mother board and the user interface boards. If you do not hear the beep, replace the mother board.

Element not heating:

If an element or portion of an element does not heat but the display shows the correct indication, either the mother board, the element, or the element wiring is defective.

To determine which is defective:

1. Turn all surface element switches **off**.
2. Check the wiring diagram on the range to see which terminal on the mother board is wired to that element or portion of that element.
3. With a voltmeter measure the voltage drop between that terminal and neutral on the mother board. If the meter reads line to neutral voltage (120 VAC) the mother board is defective. If the meter reads zero the element or wiring to the element is defective.
4. Turn the switch to high, raise the cooktop, and measure the voltage drop across the element. If the meter reads line to line voltage (240 VAC) the element is defective. If the meter reads zero the wiring is bad.

Warm and serve zone:

The warm and serve zone circuit on smooth top ranges uses a line to neutral (120 VAC) standard infinite switch, a line to neutral (120 VAC) element with a built-in limiter to protect the glass, and an indicator light.

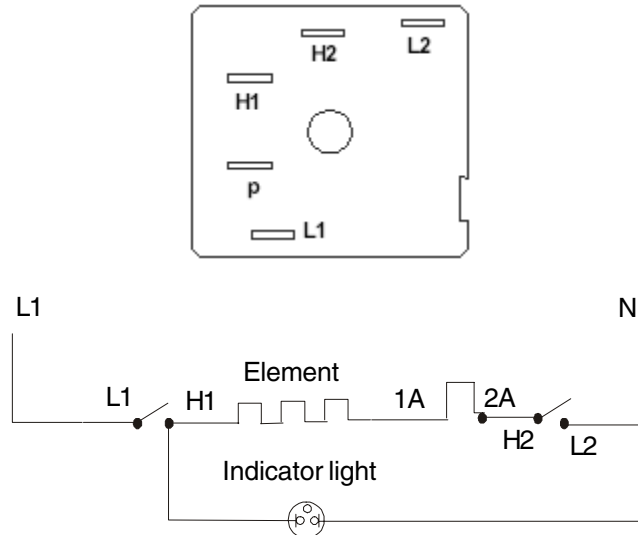

Troubleshooting:

There are four ways a warming zone system with a standard 120 VAC infinite switch can fail:

1. The element does not heat.
2. The switch does not cycle the element off and on when set to a position other than high.
3. The element operates correctly, but the indicator light does not glow.
4. Indicator light glows with all the infinite switches in the off position.

NOTE: If the indicator light glows very dimly with the switches in the off position, this is caused by a capacitive feed over in the wiring and can be corrected by connecting a 100,000 Ohm 1/4 watt resistor in parallel with the light.

Element does not heat:

Checking the system with a Voltmeter, if the element does not heat up:

1. Remove the back panel of the backguard to expose the switch terminals.
2. With a Voltmeter set for AC on a scale higher than 120 Volts measure the voltage drop between terminals L1 and L2. If the meter reads zero the

wiring between the main terminal block of the range and the switch is open. If the meter reads line to neutral voltage (around 120 VAC) go to step 3.

3. With the switch turned on to the high position measure the voltage drop between terminals H1 and H2. If the meter reads zero the switch is defective. If the meter reads line to neutral voltage the switch is good. Go to step 4.
4. Raise the top and locate the two terminals on the element with the wires from H1 and H2. Measure the voltage drop between the two terminals. If the meter reads zero, the wires between the switch and the element are open. If the meter reads line to neutral (120 VAC) the element is defective.

Element does not cycle:

If the element does not cycle when the switch is set in a position other than high the switch is defective.

Indicator light does not glow:

If the indicator light does not glow when the switch is turned on, remove the back panel of the backguard, turn the switch on, and measure the voltage drop between terminals H1 and neutral. If the meter reads zero the switch is defective. If the meter reads line to neutral voltage (around 120 VAC) the light or the wiring to the light is defective.

Indicator light glows full brilliance with the warm and serve switch turned off:

If indicator light glows full brilliance with the warm and serve switch off, the switch is defective.

SECTION D - ELECTRONIC OVEN CONTROL SYSTEMS

This section covers five electronic oven control systems.

1. ES 100
2. ES 200
3. ES 300
4. ES 400
5. ES 450
6. PRC Glass touch

The ES 100 Electronic Oven Control System:

The ES 100 electronic oven control system is used to control ovens on non self-cleaning model ranges.

How to program the ES 100:

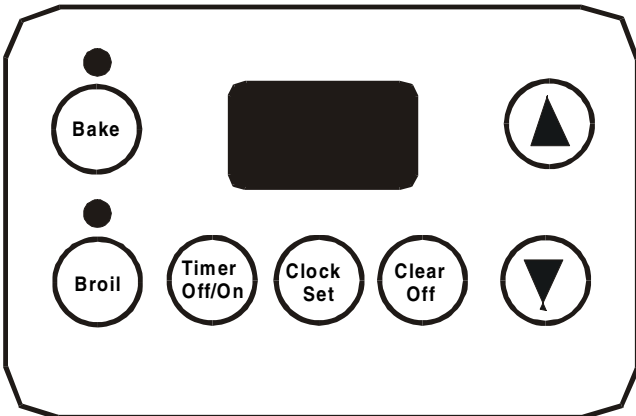

To set the clock:

When the range is first plugged in, or when the power supply to the range has been interrupted, the display will flash "12:00".

1. Press **Clock Set**.
2. Within 5 seconds, press and hold the **Up Arrow** or **Down Arrow** until the correct time of day appears in the display.

To set the minute timer:

1. Press **Timer ON/OFF**.

2. Press the **Up Arrow** to increase the time in one minute increments. Press and hold the **Up Arrow** to increase the time in 10 minute increments. The timer can be set for any amount of time from 1 minute to 11 hours and 59 minutes. (Note: If you press the **Down Arrow** first, the timer will advance to 11 hours and 59 minutes.)
3. The display shows the timer count down in minutes until one minute remains. Then the display will count down in seconds.
4. When the set time has run out, the timer will sound a 3 second beep. 0:00 will appear in the display until **Timer ON/OFF** is pressed.

NOTE: While the minute timer is counting down, the ":" will flash. The minute timer does not start or stop cooking. It serves as an extra timer in the kitchen that will beep when the set time has run out. The minute timer can be used alone or during any of the other oven functions. When the minute timer is in use with any other function, the minute timer will be shown in the display. To view other functions, press the pad for that function.

To change the minute timer while it is in use:

While the timer is active and shows in the display, press and hold the **Up Arrow** or **Down Arrow** to increase or decrease the time.

To cancel the minute timer before the set time has run out:

Press **Timer ON/OFF**.

To set or change the temperature for baking:

The oven can be programmed to bake at any temperature from 170°F to 500°F.

To set the controls for baking:

1. Press **Bake**. "— — —°" appears in the display.
2. Within 5 seconds, press the **Up Arrow** or **Down Arrow**. The display will show "350°F." By pressing and holding the **Up Arrow** or **Down Arrow**, the temperature can then be adjusted in small 5°F increments.
3. When the **Up Arrow** or **Down Arrow** is released, the oven will begin heating to the selected temperature. When the displayed temperature reaches the desired baking temperature, the control will beep 3 times.
4. To cancel the baking function, press **Clear Off**.

To change the oven temperature after baking has started:

1. Press **Bake** and make sure the bake temperature is displayed.
2. Press the **Up Arrow** or **Down Arrow** to increase or decrease the set temperature.

To broil:

1. Arrange oven rack while oven is still cool. Position the rack as suggested in the chart below.

Rack Position From Top	Food
1	Rare steaks
2	Fish, medium s t e a k s , hamburgers and chops
3	Well-done foods such as chicken and lobster

2. Press **Broil**.
3. Press the **Up Arrow** for **HI** broil or the **Down Arrow** for **LO** broil. Most foods can be broiled at the **HI** broil setting. Select the **LO** broil setting to avoid excess browning or drying of foods that should be broiled to the well-done stage.
4. Place the insert on the broiler pan, then place the food on the insert. **DO NOT** use the broiler pan without the insert or cover the insert with aluminum foil. The exposed grease could ignite.
5. Place the pan on the oven rack. **Open the oven door to the broil stop position when broiling.**
6. Broil on one side until food is browned; turn and cook on the second side. **Note:** Always pull the rack out to the stop position before turning or removing food.
7. When broiling is finished, press **Clear Off**.

CAUTION: SHOULD AN OVEN FIRE OCCUR CLOSE THE OVEN DOOR AND TURN OFF THE OVEN. IF THE FIRE CONTINUES, USE A FIRE EXTINGUISHER. DO NOT PUT WATER OR FLOUR ON THE FIRE. FLOUR MAY BE EXPLOSIVE.

How the ES 100 operates:

CAUTION: NEVER ATTEMPT TO REMOVE EITHER THE BAKE OR BROIL ELEMENT WITHOUT DISCONNECTING ELECTRICAL POWER FROM THE RANGE. ELECTRICAL POWER IS CONNECTED TO THE ELEMENTS WHENEVER ELECTRICAL POWER IS CONNECTED TO THE RANGE.

The ES 100 electronic oven control system is made up of two parts that control the bake and broil elements.

1. Electronic oven control.
2. Oven temperature sensor.

Bake:

Cooking mode that provides a controlled temperature in the oven cavity the bake element and optionally the broil element off and on. When the bake pad is touched, and a temperature is set with the up or down arrows, the bake relay on the board closes. This connects one side of the line to the bake element. In the tip of the oven sensor is a positive thermistor that increases in resistance as the oven temperature increases. The microprocessor reads the resistance of the oven sensor, and compares it with programmed temperature set into the control. When the resistance of the oven sensor indicates temperature in the oven is about 10 degrees above the programmed temperature, the microprocessor opens the relay, which removes power from one side of the element. When power is removed from the element the oven temperature begins to lower. As the oven temperature lowers the resistance of the oven sensor decreases. When the oven drops to about 10 degrees below the programmed temperature, the resistance of the sensor tells the microprocessor to close the bake relay contacts, and provide power to the bake element once again.

NOTE: Oven controls may have a temperature swing of more or less than 20 degrees. The important thing is the average temperature in the oven. The average temperature in the center of the oven should be within 10 degrees of the programmed temperature.

Broil:

When the broil pad is touched, and High or Low is set with the up or down arrows, the broil relay on the board closes. This connects one side of the line to the broil element. In the tip of the oven sensor is a positive thermistor that increases in resistance as the oven temperature increases. The microprocessor reads the resistance of the oven sensor, and compares it with a programmed temperature set into the control. Usually

you do not want the broil element to cycle so the oven door is opened to the broil stop position. If the door is not opened the broil element will cycle when the set temperature is reached.

Calibration:

To check oven calibration:

1. Place a thermometer or thermocouple in the center of the oven.
2. Program the oven for bake and the temperature to 350° F. Allow the oven to cycle three times.
3. Average the highest and lowest readings. The average should be within 10° of 350° F.

The calibration of the ES 100 system cannot be adjusted:

1. If the oven temperature calibration is off. Check the resistance of the oven sensor circuit against the chart below. If the sensor circuit checks good replace the control.

RTD	SCALE
Temperature Degrees F.	Resistance (Ohms)
32 +/- 1.9	1000 +/- 4.0
75 +/- 2.5	1091 +/- 5.3
250 +/- 4.4	1453 +/- 8.9
350 +/- 5.4	1654 +/- 10.8
450 +/- 6.9	1852 +/- 13.5
550 +/- 8.2	2047 +/- 15.8
650 +/- 9.6	2237 +/- 18.5
900 +/- 13.6	2697 +/- 24.4

Troubleshooting:

The ES 100 has some self diagnostics built into the microprocessor to help in troubleshooting the system. When a failure occurs one of two codes will appear in of the display window: F1 or F3.

F1 code:

An F1 indicates a malfunction in the EOC itself, and the control should be replaced.

F3 code:

An F3 indicates a defective sensor, electronic oven control or the wiring in between. To determine which part is defective:

1. Disconnect the 6 pin plug from the back of the oven control that connects the sensor to the oven control.

2. With an Ohmmeter measure the resistance between pins 1 and 2 in the plug (not on the control board). If the meter reads around the value of the oven temperature sensor shown in the below resistance chart, the oven control is defective. If the meter reads less than 800 Ohms or more than 3000 Ohms, go to step 3.

RTD	SCALE
Temperature Degrees F.	Resistance (Ohms)
32 +/- 1.9	1000 +/- 4.0
75 +/- 2.5	1091 +/- 5.3
250 +/- 4.4	1453 +/- 8.9
350 +/- 5.4	1654 +/- 10.8
450 +/- 6.9	1852 +/- 13.5
550 +/- 8.2	2047 +/- 15.8
650 +/- 9.6	2237 +/- 18.5
900 +/- 13.6	2697 +/- 24.4

3. Disconnect the harness from the oven sensor and measure the resistance of the oven sensor. If the reading is less than 800 Ohms or more than 3000 Ohms, the oven sensor is defective. If the reading is correct with the chart, the harness is defective.

Control will not program:

If the control will not program check for an open sensor circuit. If the sensor circuit is good replace the control.

Blank Display:

If the display on the oven control is blank and the range is connected to electrical power:

1. Go to the back of the control and measure the voltage drop between terminals L1 and 4 of the 6 pin plug. If the meter reads line to neutral voltage(120 VAC) the control is defective. If the meter reads zero, the wiring in the range is defective.

No heat:

If the control appears to be operating normally but the bake and broil elements do not heat:

1. Go to the back of the oven control and measure the voltage drop between terminals BA and pin 4 of the 6 pin plug (neutral) with the control not programmed (clock operating only). If the meter reads line to neutral (120 VAC) the control is defective. If the meter reads zero the thermal circuit breaker or the wiring from L2 is defective. Go to step 2.
2. Remove the back panel from the range to gain access to the terminals of the thermal circuit breaker.

Program the oven control for bake and measure the voltage drop across the terminals of the thermal circuit breaker. If the meter reads line to line voltage (240 VAC) the thermal circuit breaker is defective. If the meter reads zero the wiring from L2 is open.

If the control appears to be operating normally, the broil element heats but the bake element does not heat:

1. Go to the back of the oven control and measure the voltage drop between terminals BA and pin 4 of the 6 pin plug (neutral) with the control not programmed (clock operating only). If the meter reads line to neutral (120 VAC) the control is defective. If the meter reads zero the bake element or the wiring to the bake element is defective. Go to step 2.
2. Remove the back panel from the range to gain access to the terminals of the bake element. Program the oven control for bake and measure the voltage drop across the terminals of the bake element. If the meter reads line to line voltage (240 VAC) the element is defective. If the meter reads zero the wiring to the element is open.

If the control appears to be operating normally, the bake element heats, but the broil element does not heat:

1. Go to the back of the oven control and measure the voltage drop between terminals BR and pin 4 of the 6 pin plug (neutral) with the control not programmed (clock operating only). If the meter reads line to neutral (120 VAC) the control is defective. If the meter reads zero the broil element or the wiring to the broil element is defective. Go to step 2.
2. Remove the back panel from the range to gain access to the terminals of the broil element. Program the oven control for broil and measure the voltage drop across the terminals of the broil element. If the meter reads line to line voltage (240 VAC) the element is defective. If the meter reads zero the wiring to the element is open.

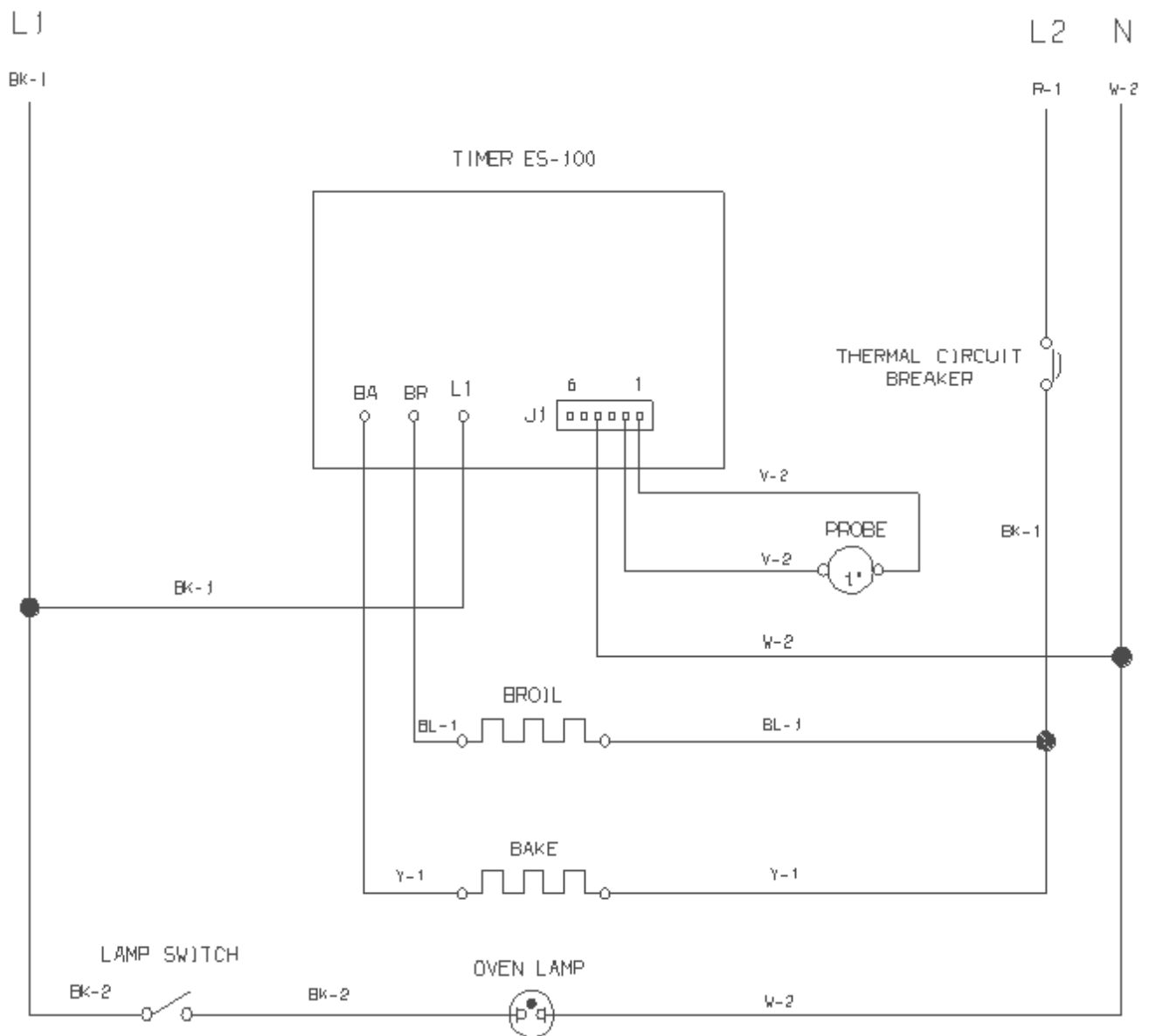

SAMPLE SCHEMATIC FOR ES100 CONTROL SYSTEM

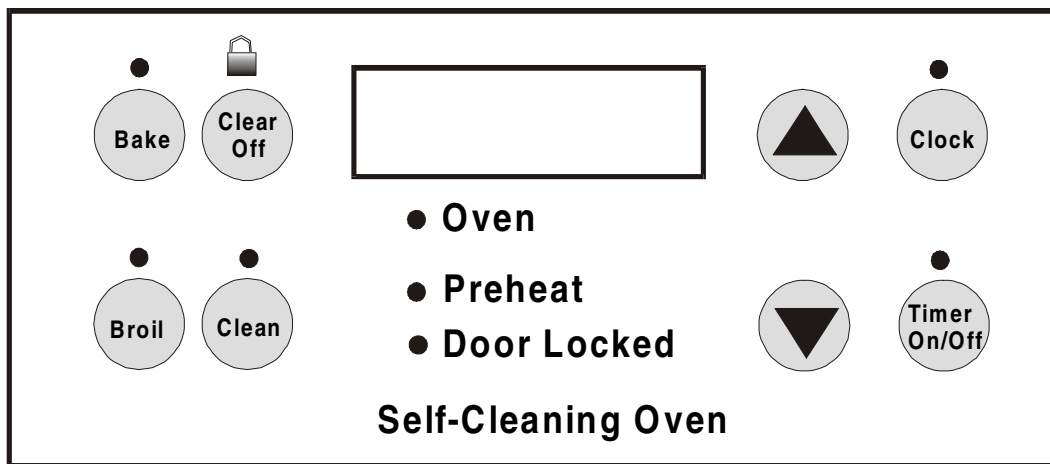

The ES 200 Electronic Oven Control System:

The ES 200 electronic oven control system is used to control the oven on self-cleaning model ranges that do not have the timed bake, speed bake or the convection features.

How to program the ES 200:

The oven can be programmed to: Bake, Broil, Self-Clean, Continuous Bake, and set for Oven Lockout.

Temperature conversion:

The electronic oven control is set to operate in °F (Fahrenheit) when shipped from the factory. The oven can be programmed for any temperature from 170° F to 550° F (65° C to 287° C Celsius).

To change the temperature from °F to °C or from °C to °F:

NOTE: Control should not be in a Bake or Clean mode.

1. Press **Broil**. "— —" appears in the display.
2. Press and hold the **Up Arrow** until "HI" appears in the display.
3. Press and hold **Broil** until °F or °C appears in the display.
4. Press the **Up Arrow or Down Arrow** to change °F to °C or °C to °F.
5. Press any control pad to return to normal operating mode.

NOTE: The time of day must first be set in order to operate the oven.

To set the clock:

When the range is first plugged in, or when the power supply to the range has been interrupted, the display will flash "12:00".

1. Press **Clock**.
2. Within 5 seconds, press and hold the **Up Arrow or Down Arrow** until the correct time of day appears in the display.

NOTE: The clock cannot be changed during the self-clean cycle.

To set the minute timer:

1. Press **Timer ON/OFF**.
2. Press the **Up Arrow** to increase the time in one minute increments. Press and hold the **Up Arrow** to increase the time in 10 minute increments. The timer can be set for any amount of time from 1 minute to 11 hours and 59 minutes.
NOTE: If you press the **Down Arrow** first, the timer will advance to 11 hours and 59 minutes.
3. The display shows the timer count down in minutes until one minute remains. Then the display will count down in seconds.
4. When the set time has run out, the timer will beep 3 times. It will then continue to beep 3 times every 60 seconds until **Timer ON/OFF** is pressed.

NOTE: The minute timer does not start or stop cooking. It serves as an extra timer in the kitchen that will beep when the set time has run out. The minute timer can be used alone or during any of the other oven functions. When the minute timer is in use with any other function, the minute timer will be shown in the display. To view other functions, press the pad for that function.

To change the minute timer while it is in use:

While the timer is active and shows in the display, press and hold the **Up Arrow or Down Arrow** to increase or decrease the time.

To cancel the minute timer before the set time has run out:

Press **Timer ON/OFF** .

To set or change the temperature for baking:

The oven can be programmed to bake at any temperature from 170° F to 550° F (65° C to 287° C).

To set the controls for baking:

1. Press **Bake**. "— — —" appears in the display.
2. Within 5 seconds, press the **Up Arrow or Down Arrow**. The display will show "350° F (177° C)." By pressing and holding the **Up Arrow or Down Arrow**, the temperature can then be adjusted in 5° F (1° C) increments.
3. As soon as the **Up Arrow or Down Arrow** is released, the oven will begin heating to the selected temperature. When the displayed temperature reaches the desired baking temperature, the control will beep 3 times.
4. To cancel the baking function, press **Clear/Off**.

To change the oven temperature after baking has started:

1. Press **Bake** and make sure the bake temperature is displayed.
2. Press the **Up Arrow or Down Arrow** to increase or decrease the set temperature.

To set control for continuous bake or 12 hour energy saving:

The oven control has a built-in 12 hour energy saving feature for bake and broil operations that will shut off the oven if the control is left on for more than 11 hours and 59 minutes. The oven can be programmed to override this feature for continuous baking.

To set control for continuous baking:

1. Press **Timer ON/OFF**, "0:00" will appear in the display.

2. Press and hold **Timer ON/OFF** down for 5 seconds until tone is heard, "— — hr" will appear in display for continuous cooking. The current time of day will return to the display.
3. To cancel the Continuous Bake function, press **Timer ON/OFF** and hold for 5 seconds until tone is heard. "12hr" will appear in display indicating that the control has returned to the 12 hour energy saving feature.

To set control for oven lockout feature:

1. Press **Clear/Off** and hold for 3 seconds. "Loc" will appear in display, the "Door Locked" indicator light will flash and the motor driven door lock will begin to close automatically. **DO NOT open oven door** while the indicator light is flashing. Allow about 15 seconds for the oven door to lock. Once the oven door is locked, the current time of day will appear in the display.
2. To cancel the lockout feature, press **Clear/Off** and hold for 3 seconds. The control will unlock the oven door and resume normal operation.

To broil:

1. Arrange oven rack while oven is still cool. Position the rack as suggested in the chart below.

Rack Position From Top	Food
1	Rare steaks
2	Fish, medium steaks, hamburgers and chops
3	Well-done foods such as chicken and lobster

2. Press **Broil**.
3. Press the **Up Arrow** for **HI** broil or the **Down Arrow** for **LO** broil. Most foods can be broiled at the **HI** broil setting. Select the **LO** broil setting to avoid excess browning or drying of foods that should be broiled to the well-done stage.
4. Place the insert on the broiler pan, then place the food on the insert. **DO NOT** use the broiler pan without the insert or cover the insert with aluminum foil. The exposed grease could ignite. Place the pan on the oven rack.

Open the oven door to the broil stop position when broiling.

6. Broil on one side until food is browned; turn and cook on the second side. **NOTE:** Always pull the rack out to the stop position before turning or removing food.
7. When broiling is finished, press **Clear/Off**.

CAUTION: SHOULD AN OVEN FIRE OCCUR, CLOSE THE OVEN DOOR AND TURN OFF THE OVEN. IF THE FIRE CONTINUES, USE A FIRE EXTINGUISHER. DO NOT PUT WATER OR FLOUR ON THE FIRE. FLOUR MAY BE EXPLOSIVE.

To set the controls for a self-clean cycle:

For satisfactory results use a 2 hour self-clean cycle for **light soils** and a 3 hour cycle for **average to heavy soils**.

1. Be sure the clock shows the correct time of day.
2. Press **Clean**. "— — —" appears in the display.
3. Press the **Up Arrow** until "3:00" appears in the display for a 3 hour cycle, or press the **Down Arrow** until "2:00" appears in the display for a 2 hour cycle.
4. As soon as the **Up Arrow** or **Down Arrow** is released, "CLN" appears in the display.
5. As soon as the controls are set, the motor driven lock will begin to close automatically and the "LOCK" indicator light will flash. **DO NOT** open the door while the light is flashing (it takes about 15 seconds for the oven door to lock).
6. The "LOCK" light will glow until the cleaning cycle is completed or cancelled, and the oven temperature has cooled.

When the self-clean cycle is completed:

1. The time of day or "END" will appear in the display window and the "Clean" and "LOCK" light will continue to glow.
2. Once the oven has cooled down for about 1 HOUR and the "LOCK" light has gone out, the oven door can be opened.
3. If "END" is in the display and the "Clean" indicator remains on, press **Clear/Off**. The time of day will appear in the display.

NOTE: When the oven is cool, wipe away any residue or powdered ash with a damp cloth or paper towel.

Stopping or interrupting a self-cleaning cycle:

If it becomes necessary to stop or interrupt a self-cleaning cycle.

1. Press **Clear/Off**.
2. Once the oven has cooled down for about 1 HOUR and the "LOCK" light has gone out, the oven door can be opened.
3. Restart the self-clean cycle once all conditions have been corrected.

How the ES 200 operates:

The ES 200 electronic oven control system is made up of three parts that control the bake and broil elements, and the locking of the door in the self-clean cycle.

1. Electronic oven control.
2. Oven temperature sensor.
3. Oven door lock mechanism.

Bake:

When the bake pad is touched, and a temperature is set with the up or down arrows, the bake relay on the board closes. This connects one side of the line to the bake element. In the tip of the oven sensor is a positive thermistor that increases in resistance as the oven temperature increases. The microprocessor reads the resistance of the oven sensor, and compares it with programmed temperature set into the control. When the resistance of the oven sensor indicates temperature in the oven is about 10 degrees above the programmed temperature, the microprocessor opens the relay, which removes power from one side of the element. When power is removed from the element the oven temperature begins to lower. As the oven temperature lowers the resistance of the oven sensor decreases. When the oven drops to about 10 degrees below the programmed temperature, the resistance of the sensor tells the microprocessor to close the bake relay contacts, and provide power to the bake element once again. After the first cycle the preheat light is turned off and whenever the oven calls for heat, the EOC cycles the broil element on for seven seconds and then the bake element on for fifty three seconds out of every minute. This provides top heat during the bake cycle. The two elements will never be on at the same time.

NOTE: Oven controls may have a temperature swing of more or less than 20 degrees. The important thing is the average temperature in the oven. The average temperature in the center of the oven should be within 10 degrees of the programmed temperature.

Broil:

When the broil pad is touched, and High or Low is set with the up or down arrows, the broil relay on the board closes. This connects one side of the line to the broil element. In the tip of the oven sensor is a positive thermistor that increases in resistance as the oven temperature increases. The microprocessor reads the resistance of the oven sensor, and compares it with a programmed temperature set into the control. Usually you do not want the broil element to cycle so the oven door is opened to the broil stop position. If the door is not opened the broil element will cycle when the set temperature is reached.

Clean:

With the oven door closed, contacts COM to NO of the oven door switch close. Then when the clean pad is touched and a clean time is set the door lock relay on the electronic oven control closes providing line to neutral voltage (120 VAC) to the lock motor. "CLN" appears in the display and the lock indicator light blinks. The lock motor starts to rotate, closing the contacts of the door lock switch. When the motor rotates one half turn the contacts of the door lock switch reopen sending a signal to the EOC that the door is locked, and to open the contacts of the lock relay. The lock indicator light then glows steady and the EOC closes the bake relay providing power to the bake element. The clean temperature is preset into the EOC at around 850° F. It takes about 45 minutes for the oven to reach 850° F. When the temperature is reached the control cycles the bake element off and on to maintain the temperature until the clean time is completed. When the clean time is completed the EOC removes power from the bake element and the oven cools down. When the temperature in the oven goes below 500° F the control closes the contacts of the lock relay. The lock motor then turns 180 degrees closing and reopening the contacts of the lock switch and unlocking the door. The open contacts of the lock switch tells the control that the door is unlocked and to open the contacts of the lock relay and turn the lock indicator light off.

Calibration:

To check oven calibration:

1. Place a thermometer or thermocouple in the center of the oven.

2. Program the oven for bake and the temperature to 350° F. Allow the oven to cycle three times.
3. Average the highest and lowest readings. The average should be within 10° of 350° F.

To change the calibration:

1. Touch the bake pad on the control, and using the up arrow set the oven temperature to 500° F or more.
2. Within 3 seconds touch and hold the bake pad (about 5 seconds) until "0" appear in the display.

NOTE: If any numbers other than "0" appear in the display, the control has been previously calibrated in the field.

3. By using the up or down arrows the calibration temperature can be changed + or - 35° F.
4. When the desired calibration is reached, touch the cancel pad to return the control to normal operation.

Troubleshooting:

The ES 200 has some self diagnostics built into the microprocessor to help in troubleshooting the system. When a failure occurs one of three codes will appear in all the display windows; F1, F3 and F9.

F1 code:

An F1 indicates a malfunction in the control itself, and the control should be replaced.

F3 code:

An F3 indicates a defective sensor, electronic oven control or the wiring in between. To determine which part is defective:

1. Disconnect the 15 pin plug from the back of the oven control that connects the sensor to the oven control.
2. With an Ohmmeter measure the resistance between pins 12 and 13 in the plug (not on the control board). If the meter reads around the value of the oven temperature sensor shown in the below resistance chart, the oven control is defective. If the meter reads less than 800 Ohms or more than 3000 Ohms, go to step 3.
3. Disconnect the harness from the oven sensor and measure the resistance of the oven sensor. If the reading is less than 800 Ohms or more than 3000

RTD	SCALE
Temperature Degrees F.	Resistance (Ohms)
32 +/- 1.9	1000 +/- 4.0
75 +/- 2.5	1091 +/- 5.3
250 +/- 4.4	1453 +/- 8.9
350 +/- 5.4	1654 +/- 10.8
450 +/- 6.9	1852 +/- 13.5
550 +/- 8.2	2047 +/- 15.8
650 +/- 9.6	2237 +/- 18.5
900 +/- 13.6	2697 +/- 24.4

Ohms, the oven sensor is defective. If the reading is correct with the chart, the harness is defective.

F9 code:

An F9 code indicates the control has detected a problem with the motor door latch assembly. Check the contacts of the lock switch, wiring to the lock motor assembly, and the lock motor.

Control will not program:

If the control will not program check for an open sensor circuit. If the sensor circuit is good replace the control.

Blank display:

If the display on the oven control is blank and the range is connected to electrical power:

1. Go to the back of the control and measure the voltage drop between terminal L1 and neutral. If the meter reads line to neutral voltage (120 VAC) the control is defective. If the meter reads zero the wiring in the range is defective.

No heat:

If the control appears to be operating normally, but the bake and broil elements do not heat:

1. Go to the back of the oven control and measure the voltage drop between terminals L1 and P4. If the meter reads zero and the display is illuminated, the wire between terminal P4 and the range terminal block is open. If the meter reads line to line voltage (240 VAC) go to step 2.
2. Program the oven for bake and measure the voltage drop between terminals BAKE and P7. If the meter reads zero the control is defective. If the meter reads line to line voltage (240 VAC) the bake element or the wiring to the bake element is defective. Go to step 3.

3. Program the oven for broil and measure the voltage drop between terminals BROIL and P7. If the meter reads zero the control is defective. If the meter reads line to line voltage (240 VAC) the broil element or the wiring to the broil element is defective.

If the control appears to be operating normally, the broil element heats, but the bake element does not heat:

1. Program the oven for bake, go to the back of the oven control and measure the voltage drop between terminals BAKE and P7. If the meter reads zero the control is defective. If the meter reads line to line voltage (240 VAC) the bake element or the wiring to the bake element is defective. Go to step 2.
2. Remove the back from the range to gain access to the terminals of the bake element. Program the oven control for bake and measure the voltage drop across the terminals of the bake element. If the meter reads line to line voltage (240 VAC) the element is defective. If the meter reads zero the wiring to the element is open.

If the control appears to be operating normally, the bake element heats, but the broil element does not heat:

1. Program the oven for broil, go to the back of the oven control and measure the voltage drop between terminals BROIL and P7. If the meter reads zero the control is defective. If the meter reads line to line voltage (240 VAC) the broil element or the wiring to the broil element is defective. Go to step 2.
2. Remove the back from the range to gain access to the terminals of the broil element. Program the oven control for broil and measure the voltage drop across the terminals of the broil element. If the meter reads line to line voltage (240 VAC) the element is defective. If the meter reads zero the wiring to the element is open.

Oven door does not lock when the oven is programmed for clean:

1. Remove power from the range and go to the back of the oven control. Remove the 15 pin plug and with the oven door closed measure the resistance between pins 5 and 6 in the plug. If the meter reads around 2400 Ohms the control is defective. If the meter reads open go to step 2.

2. Remove the rear cover from the range and measure the resistance of the lock motor. If the meter reads open the motor is defective. If the meter reads around 2400 Ohms go to step 3.
3. Remove the right-hand bodyside and measure the resistance between terminals NO and C of the door switch with the door closed. If the meter reads infinity the door switch is defective. If the meter reads zero go to step 4.
4. Measure the resistance between pins 9 and 11 of the 15 pin plug. If the meter reads infinity the lock switch is defective. If the meter reads zero replace the control.

Oven door locks when the oven is programmed for clean but the oven does not heat:

1. If the oven operates normally in bake, replace the control.

Lock motor runs continuously:

1. With the door in the unlock position, remove power from the range. Go to the back of the control and disconnect the 15 pin plug from the control. With an Ohmmeter measure the resistance between pins 9 and 10 of the 15 pin plug (not on the EOC). If the meter reads zero the lock switch or the wiring to the lock switch is defective. If the meter reads infinity go to step 2.
2. Depress the arm of the lock switch, and measure the resistance between pins 9 and 10 of the 15 pin plug. If the meter reads infinity the lock switch or the wiring to the lock switch is defective. If the meter reads zero the control is defective.

Door latch is partly closed with door open, cannot close door:

1. Program the oven for self-clean, remove the right-hand side panel and hold the oven door switch closed, the latch mechanism should rotate close. After 30 seconds touch clear and the latch mechanism should rotate open.

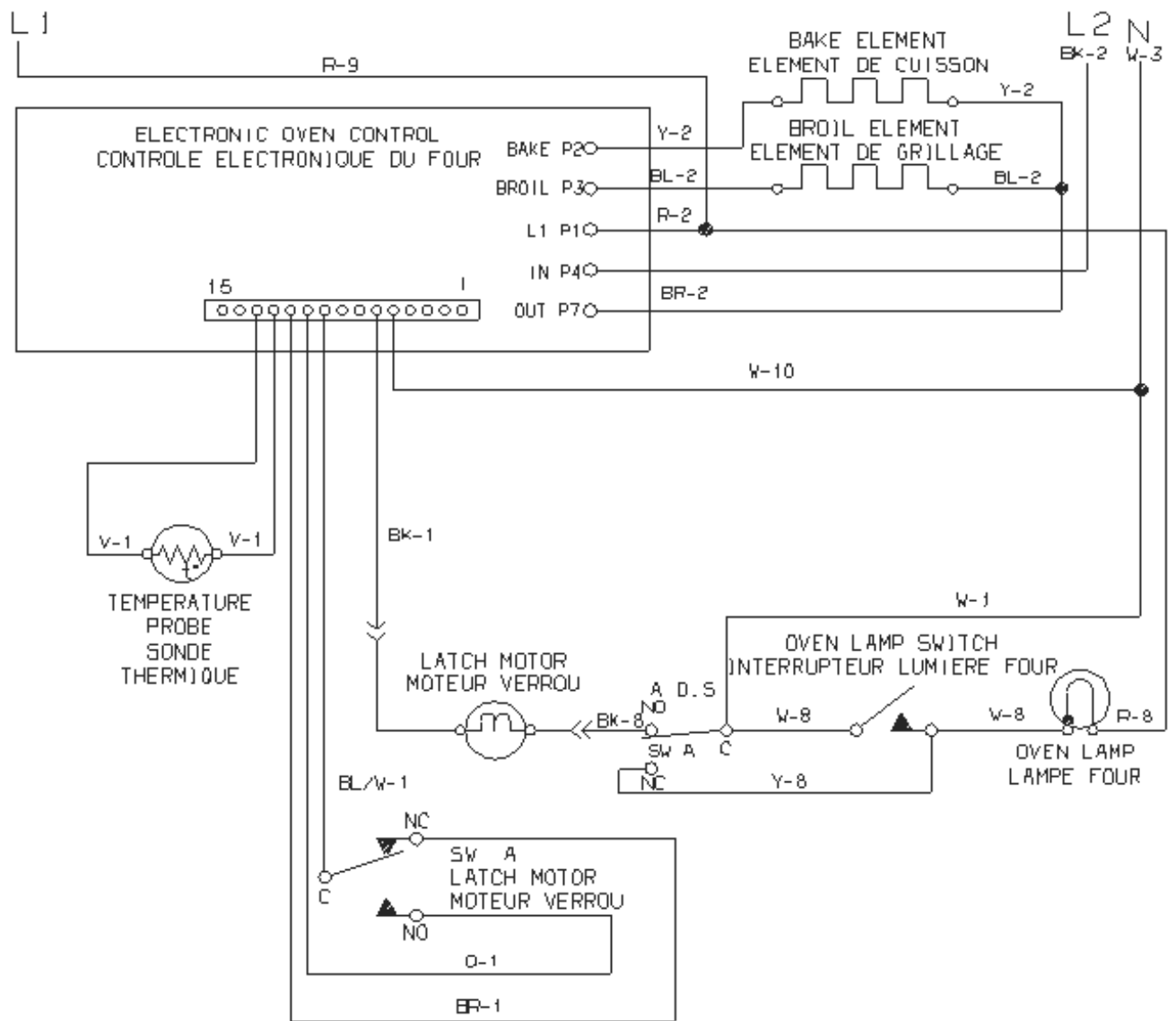

SAMPLE SCHEMATIC FOR THE ES 200 CONTROL SYSTEM

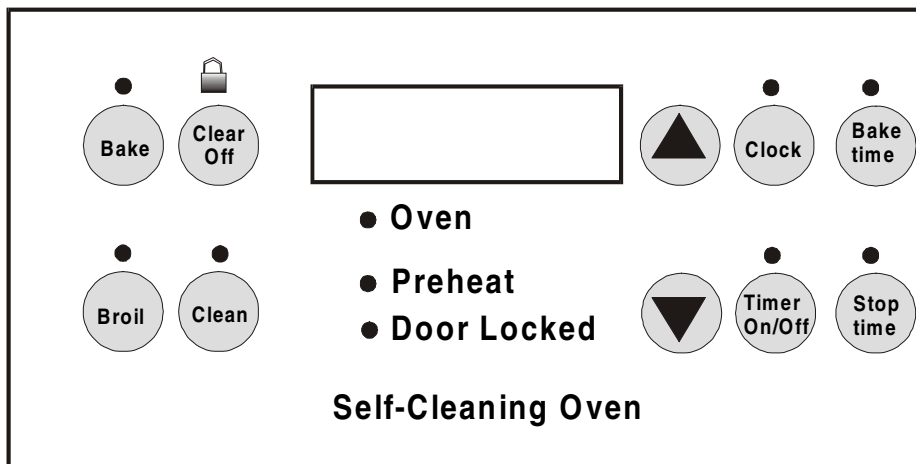

The ES 300 Electronic Oven Control System:

The ES 300 electronic oven control system is used to control the oven on self-cleaning model ranges that do not have the convection feature.

How to program the ES 300:

The oven can be programmed to: Bake, Timed Bake, Speed Bake, Broil, Self-Clean, Continuous Bake, and set for Oven Lockout.

For a silent control panel:

When choosing a function, a beep will be heard each time a pad is pressed. If desired, the controls can be programmed for silent operation. Press and hold **Stop time**. After 7 seconds, the control will beep once. This will block the controls from sounding when a pad is pressed. To return the sound, press and hold **Stop time** again for 7 seconds until the control beeps once.

NOTE: The control will return to the audible mode after a power outage.

Temperature conversion:

The electronic oven control is set to operate in °F (Fahrenheit) when shipped from the factory. The oven can be programmed for any temperature from 170° F to 550° F (65° C to 287° C).

To change the temperature from °F to °C or from °C to °F (control should not be in a bake or clean mode):

1. Press **Broil**. "— —" appears in the display.
2. Press and hold the **Up Arrow** until "HI" appears in the display.
3. Press and hold **Broil** until °F or °C appears in the display.

4. Press the **Up Arrow** or **Down Arrow** to change °F to °C or °C to °F.
5. Press any control pad to return to normal operating mode.

To set the clock:

When the range is first plugged in, or when the power supply to the range has been interrupted, the display will flash "12:00".

1. Press **Clock**.
2. Within 5 seconds, press and hold the **Up Arrow** or **Down Arrow** until the correct time of day appears in the display.

NOTE: The clock cannot be changed during any timed bake or self-clean cycle.

To set the minute timer:

1. Press **Timer On/Off**.
2. Press the **Up Arrow** to increase the time in one minute increments. Press and hold the **Up Arrow** to increase the time in 10 minute increments. The timer can be set for any amount of time from 1 minute to 11 hours and 59 minutes.

NOTE: If you press the **Down Arrow** first, the timer will advance to 11 hours and 59 minutes.

3. The display shows the timer count down in minutes until one minute remains. Then the display will count down in seconds.
4. When the set time has run out, the timer will beep 3 times. It will then continue to beep 3 times every 60 seconds until **Timer On/Off** is pressed.

NOTE: The minute timer does not start or stop cooking. It serves as an extra timer in the kitchen that will beep when the set time has run out. The minute timer can be used alone or during any of the other oven functions. When the minute timer is in use with any other function, the minute timer will be shown in the display. To view other functions, press the pad for that function.

To change the minute timer while it is in use:

While the timer is active and shows in the display, press and hold the **Up Arrow** or **Down Arrow** to increase or decrease the time.

To cancel the minute timer before the set time has run out:

Press **Timer On/Off**.

To set or change the temperature for baking:

The oven can be programmed to bake at any temperature from 170° F to 550° F (65° C to 287° C).

To set the controls for baking:

1. Press **Bake**. "— — —" appears in the display.
2. Within 5 seconds, press the **Up Arrow** or **Down Arrow**. The display will show "350° F (177° C)." By pressing and holding the **Up Arrow** or **Down Arrow**, the temperature can then be adjusted in 5° F (1° C) increments.
3. As soon as the **Up Arrow** or **Down Arrow** is released, the oven will begin heating to the selected temperature. When the displayed temperature reaches the desired baking temperature, the control will beep 3 times.
4. To cancel the baking function, press **Clear Off**.

To change the oven temperature after baking has started:

1. Press **Bake** and make sure the bake temperature is displayed.
2. Press the **Up Arrow** or **Down Arrow** to increase or decrease the set temperature.

To set control for continuous bake or 12 hour energy saving:

The oven control has a built-in 12 hour energy saving feature for bake and broil operations that will shut off the oven if the control is left on for more than 11 hours and 59 minutes. The oven can be programmed to override this feature for continuous baking.

To set control for continuous baking:

1. Press **Timer On/Off**, "0:00" will appear in the display.
2. Press and hold **Timer On/Off** down for 5 seconds until tone is heard, "— — hr" will appear in display for continuous cooking. The current time of day will return to the display.
3. To cancel the Continuous Bake function, press **Timer On/Off** and hold for 5 seconds until tone is heard. "12hr" will appear in display indicating that the control has returned to the 12 hour energy saving feature.

To set control for oven lockout feature:

1. Press **Clear Off** and hold for 3 seconds. "Loc" will appear in display, the "Door Locked" indicator light will flash and the motor driven door lock will begin to close automatically. **DO NOT open oven door** while the indicator light is flashing. Allow about 15 seconds for the oven door to lock. Once the oven door is locked, the current time of day will appear in the display.
2. To cancel the lockout feature, press **Clear Off** and hold for 3 seconds. The control will unlock the oven door and resume normal operation.

To set the timed bake feature:

The **BAKE TIME** and **STOP TIME** controls operate the Timed Bake feature to turn the oven on and off at the times you select in advance. The oven can be programmed to start immediately and shut off automatically or to begin baking at a later time with an automatic shutoff.

To program the oven to begin baking immediately and to shut off automatically:

1. Be sure that the clock shows the correct time of day.
2. Place the food in the oven.
3. Press **Bake**.
4. Within 5 seconds, press the **Up Arrow** or **Down Arrow**. The display will show "350° F (177° C)." By holding the **Up Arrow** or **Down Arrow**, the temperature can then be adjusted in 5° F (1° C) increments.
5. Press **Bake Time**. "0:00" will flash in the display.
6. Press the **Up Arrow** or **Down Arrow** until the desired baking time appears in the display.

- The oven will turn on and begin heating.

To program oven for a delayed start time and to shut-off automatically:

- Be sure that the clock shows the correct time of day.
- Place the food in the oven.
- Press **Bake**.
- Within 5 seconds, press the **Up Arrow** or **Down Arrow**. The display will show "350° F (177° C)." By holding the **Up Arrow** or **Down Arrow**, the temperature can then be adjusted in 5° F (1° C) increments.
- Press **Bake Time**. "0:00" will flash in the display.
- Press the **Up Arrow** or **Down Arrow** until the desired baking time appears.
- Press **Stop Time**. The earliest possible stop time will flash in the display.
- Press the **Up Arrow** or **Down Arrow** until the desired stop time appears in the display.
- Once the controls are set, the control calculates the time when baking will start in order to finish at the time you have set.
- The oven will turn on at the delayed start time and begin heating.

When the set bake time runs out:

- "END" will appear in the display window and the oven will shut off automatically.
- The control will beep 3 times every 60 seconds until **Clear Off** is pressed.

To change the oven temperature or bake time after baking has started:

- Press the function pad you want to change.
- Press the **Up Arrow** or **Down Arrow** to adjust the setting.

CAUTION: Use caution with the Timed Bake feature to cook cured or frozen meats and most fruits and vegetables. Foods that can easily spoil such as milk, eggs, fish, meat or poultry, should be chilled in the refrigerator first. Even when chilled, they should not stand in the oven for more than 1 hour before cooking begins, and should be removed

promptly when cooking is completed.

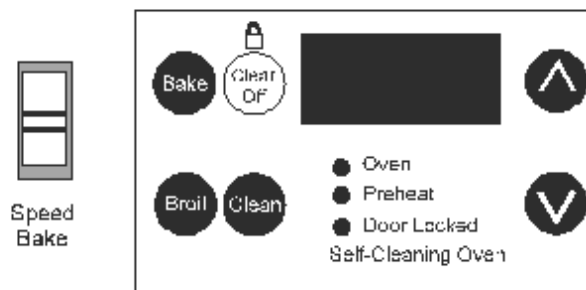

Speed Bake™ Cooking System (if equipped) uses a fan to circulate the oven's heat uniformly and continuously around the oven. This improved heat distribution allows for fast, even cooking and browning results. It also gives better baking results when using two racks at the same time. Heated air flows around the food from all sides, sealing in juices and flavors. Meats cooked with the **Speed Bake™ Cooking System** are juicier. Poultry is crisp on the outside while staying tender and moist on the inside. Breads and pastries brown more evenly. Most foods baked in a standard oven can be cooked faster and more evenly with the **Speed Bake™ Cooking System**.

General cooking instructions:

- To convert baking times for normal recipes to **Speed Bake** times, start with a 30% reduction in time and increase the time until the desired doneness is obtained. Time reductions will vary depending on the amount and type of food.
- Preheating is not necessary when cooking with **Speed Bake**, except with items such as cakes, cookies, biscuits, breads, etc.
- When using two racks at the same time, place in positions 2 and 5 for the best results.
- When baking cakes with **Speed Bake**, set temperature 25° F (13° C) degrees lower than the recommended setting for best results.

To set Speed Bake™ Cooking System:

- Program the oven as you normally would for baking. **Speed Bake** may be used with Bake, Time Bake and Delayed Time Bake features.
- Press and release **Speed Bake** switch. The indicator light will glow and the fan will come on. The fan stays on when the oven door is closed and shuts off while the oven door is opened. The fan will continue to operate until baking is complete.

- To cancel the **Speed Bake** function, press **Clear Off** on the oven control as you would to cancel any baking function.

NOTE: The Speed Bake feature will not work during a clean cycle.

To broil:

- Arrange oven rack while oven is still cool. Position the rack as suggested in the chart below.

Rack Position From Top	Food
1	Rare steaks
2	Fish, medium steaks, hamburgers and chops
3	Well-done foods such as chicken and lobster

- Press **Broil**.
- Press the **Up Arrow** for **HI** broil or the **Down Arrow** for **LO** broil. Most foods can be broiled at the **HI** broil setting. Select the **LO** broil setting to avoid excess browning or drying of foods that should be broiled to the well-done stage.
- Place the insert on the broiler pan, then place the food on the insert. **DO NOT** use the broiler pan without the insert or cover the insert with aluminum foil. The exposed grease could ignite.
- Place the pan on the oven rack. **Open the oven door to the broil stop position when broiling foods.**
- Broil on one side until food is browned; turn and cook on the second side. **NOTE:** Always pull the rack out to the stop position before turning or removing food.
- When broiling is finished, press **Clear Off**.

CAUTION: SHOULD AN OVEN FIRE OCCUR, CLOSE THE OVEN DOOR AND TURN OFF THE OVEN. IF THE FIRE CONTINUES, USE A FIRE EXTINGUISHER. DO NOT PUT WATER OR FLOUR ON THE FIRE. FLOUR MAY BE EXPLOSIVE.

Self-cleaning oven:

A self-cleaning oven cleans itself with high temperatures (well above cooking temperatures) which eliminate soil completely or reduce it to a fine powdered ash you can wipe away with a damp cloth.

Adhere to the following cleaning precautions:

- DO NOT** use oven cleaners or oven protective coatings in or around any part of the self-cleaning oven.
- DO NOT** clean the oven door gasket. The woven material of the oven door gasket is essential for a good seal. Care should be taken not to rub, damage or remove the gasket.
- DO NOT** use any cleaning materials on the oven door gasket. Doing so could cause damage.
- Remove the broiler pan and insert, all utensils and any aluminum foil. These items cannot withstand high cleaning temperatures.**
- Oven racks may be left in the oven or may be removed. If they go through the clean cycle their color will turn slightly blue and the finish will be dull. After the cycle is complete and the oven has cooled, rub the sides of the racks with wax paper or a cloth containing a small amount of baby oil or salad oil (this will make the racks glide easier into the rack position).
- Remove any excess spillovers** in the oven cavity **before** starting the self-cleaning cycle. To clean, use hot, soapy water and a cloth. Large spillovers can cause heavy smoke or fire when subjected to high temperatures. **DO NOT** allow food spills with a high sugar or acid content (such as milk, tomatoes, sauerkraut, fruit juices or pie filling) to remain on the surface as they may leave a dull spot even after cleaning.
- Clean any soil from the oven frame, the door liner outside the oven door gasket and the small area at the front center of the oven bottom. These areas heat sufficiently to burn soil on. Clean with soap and water.

NOTE: Prior to setting the Self-Clean cycle, any spills remaining on the oven bottom should be removed.

Some models have a recessed well for the bake element. On these models, the bake element is designed to be tilted up using your hand from the front of the bake element. This will allow easier access to the oven bottom

for cleaning. Be careful not to raise the element more than 4 or 5 inches from the resting position.

To set the controls for a self-clean cycle:

For satisfactory results use a 2 hour cycle for **light soils** and a 3 hour cycle for **average to heavy soils**.

1. Be sure the clock shows the correct time of day.
2. Press **Clean**. "— — —" appears in the display.
3. Press the **Up Arrow** until "3:00" appears in the display for a 3 hour cycle, or press the **Down Arrow** until "2:00" appears in the display for a 2 hour cycle.
4. As soon as the **Up Arrow or Down Arrow** is released, "CLN" appears in the display.
5. As soon as the controls are set, the motor driven lock will begin to close automatically and the "LOCK" indicator light will flash. **DO NOT** open the door while the light is flashing (it takes about 15 seconds for the oven door to lock).
6. The "LOCK" light will glow until the cleaning cycle is completed or cancelled, and the oven temperature has cooled.

When the self-clean cycle is completed:

1. The time of day or "END" will appear in the display window and the "Clean" and "LOCK" light will continue to glow.
2. Once the oven has cooled down for about 1 hour and the "LOCK" light has gone out, the oven door can be opened.
3. If "End" is in the display and the "Clean" indicator remains on, press **Clear Off**. The time of day will appear in the display.

NOTE: When the oven is cool, wipe away any residue or powdered ash with a damp cloth or paper towel.

Stopping or interrupting a self-cleaning cycle:

1. Press **Clear Off**.
2. Once the oven has cooled down for about 1 HOUR and the "LOCK" light has gone out, the oven door can be opened.
3. Restart the self-clean cycle once all conditions have been corrected.

CAUTION: Use care when opening the oven door after the self-cleaning cycle. Stand to the side of the oven when opening the door to allow hot air or steam to escape.

CAUTION: DO NOT force the oven door open. This can damage the automatic door locking system. Use caution when opening the door after the self-cleaning cycle is completed. The oven may still be VERY HOT.

How the ES 300 control system works:

The ES 300 electronic oven control system is made up of four parts that control the bake and broil elements, the speed bake fan in the oven, (optional) and the locking of the door in the self-clean cycle.

1. Electronic oven control.
2. Oven temperature sensor.
3. Oven door lock mechanism.
4. Speed bake switch. (optional)

Bake:

When the bake pad is touched, and a temperature is set with the up or down arrows, the bake relay on the board closes. This connects one side of the line to the bake element, and the preheat and oven lights on the control glow. In the tip of the oven sensor is a positive thermistor that increases in resistance as the oven temperature increases. The microprocessor in the EOC reads the resistance of the oven sensor and compares it with a programmed temperature set into the control. When the resistance of the oven sensor indicates the temperature in the oven is about 10 degrees above the programmed temperature, the microprocessor opens the relay which removes power from the element. When power is removed from the element the oven temperature begins to lower. As the oven temperature lowers, the resistance of the oven sensor decreases. When the oven drops to about 10 degrees below the programmed temperature the resistance of the sensor tells the microprocessor to close the relay contacts, and provide power to the element. After the first cycle, the preheat light is turned off. Then whenever the oven calls for heat the control cycles the broil element on for seven seconds and the bake element on for fifty three seconds out of every minute. This provides top heat during the bake cycle.

Note: The two elements are never on at the same time.

NOTE: Oven controls may have a temperature swing of more or less than 20 degrees. The important thing is the average temperature in the oven. The average temperature in the center of the oven should be within 10 degrees of the programmed temperature.

Time bake:

The time bake function allows the oven to be programmed to stop baking at a set time, or to delay the start and stop baking at a set time. The stop time cannot be set for more than 11 hours and 59 minutes ahead of the time of day.

Broil:

When the broil pad is touched, and High or Low is set with the up or down arrows, the broil relay on the board closes. This connects one side of the line to the broil element. In the tip of the oven sensor is a positive thermistor that increases in resistance as the oven temperature increases. The microprocessor reads the resistance of the oven sensor, and compares it with the programmed temperature set into the control. Usually you do not want the broil element to cycle, so the oven door is opened to the broil stop position. If the door is not opened the broil element will cycle when the set temperature is reached.

Speed bake:

Speed bake operates the same as the bake cycle. However, when the speed bake switch is touched the contacts of the speed bake relay on the EOC close providing line to neutral (120 VAC) to the speed bake fan in the oven. This fan operates continuously until the clear/off is touched. If the oven door is open during a speed bake operation the fan stops, but it restarts when the door is closed.

Clean:

With the oven door closed, contacts COM to NO of the oven door switch close. Then when the clean pad is touched and a clean time is set the door lock relay on the electronic oven control closes providing line to neutral voltage (120 VAC) to the lock motor. "CLN" appears in the display and the lock indicator light blinks. The lock motor starts to rotate, closing the contacts of the door lock switch. When the motor rotates one half turn the contacts of the door lock switch reopen sending a signal to the EOC that the door is locked, and to open the contacts of the lock relay. The lock indicator light then glows steady and the EOC closes the bake relay providing power to the bake element. The clean temperature is preset into the EOC at around 850° F. It takes about 45 minutes for the oven to reach 850° F.

When the temperature is reached the control cycles the bake element off and on to maintain the temperature until the clean time is completed. When the clean time is completed the EOC removes power from the bake element and the oven cools down. When the temperature in the oven goes below 500° F the control closes the contacts of the lock relay. The lock motor then turns 180 degrees closing and reopening the contacts of the lock switch and unlocking the door. The open contacts of the lock switch tells the control that the door is unlocked and to open the contacts of the lock relay and turn the lock indicator light off.

Calibration:

To check oven calibration:

1. Place a thermometer or thermocouple in the center of the oven.
2. Program the oven for bake and the temperature to 350° F. Allow the oven to cycle three times.
3. Average the highest and lowest readings. The average should be within 10° of 350° F.

To change the calibration:

1. Touch the bake pad on the control, and using the up arrow set the oven temperature to 500° F or more.
2. Within 3 seconds touch and hold the bake pad (about 5 seconds) until "0" appear in the display.

NOTE: If any numbers other than "0" appear in the display, the control has been previously calibrated in the field.

3. By using the up or down arrows the calibration temperature can be changed + or - 35° F.
4. When the desired calibration is reached, touch the cancel pad to return the control to normal operation.

Troubleshooting:

The ES 300 has some self diagnostics built into the microprocessor to help in troubleshooting the system. When a failure occurs one of three codes will appear in all the display windows; F1, F3 and F9.

F1 code:

An F1 indicates a malfunction in the control itself, and the control should be replaced.

F3 code:

An F3 indicates a defective sensor, electronic oven control or the wiring in between. To determine which part is defective:

1. Disconnect the 15 pin plug from the back of the oven control that connects the sensor to the oven control.
2. With an Ohmmeter measure the resistance between pins 12 and 13 in the plug (not on the control board). If the meter reads around the value of the oven temperature sensor shown in the below resistance chart, the oven control is defective. If the meter reads less than 800 Ohms or more than 3000 Ohms, go to step 3.

RTD	SCALE
Temperature Degrees F.	Resistance (Ohms)
32 +/- 1.9	1000 +/- 4.0
75 +/- 2.5	1091 +/- 5.3
250 +/- 4.4	1453 +/- 8.9
350 +/- 5.4	1654 +/- 10.8
450 +/- 6.9	1852 +/- 13.5
550 +/- 8.2	2047 +/- 15.8
650 +/- 9.6	2237 +/- 18.5
900 +/- 13.6	2697 +/- 24.4

3. Disconnect the harness from the oven sensor and measure the resistance of the oven sensor. If the reading is less than 800 Ohms or more than 3000 Ohms, the oven sensor is defective. If the reading is correct with the chart, the harness is defective.

F9 code:

An F9 code indicates the control has detected a problem with the motor door latch assembly. Check the contacts of the lock switch, wiring to the lock motor assembly, and the lock motor.

Control will not program:

If the control will not program check for an open sensor circuit. If the sensor circuit is good replace the control.

Time bake does not operate:

If the normal bake feature operates but the time bake feature does not operate check to be sure it is being programmed correctly. If so, replace the EOC.

Blank display:

If the display on the oven control is blank and the range connected to electrical power:

1. Go to the back of the control and measure the voltage drop between terminal L1 and neutral. If the meter reads line to neutral voltage (120 VAC) the control is defective. If the meter reads zero the wiring in the range is defective.

No heat:**If the control appears to be operating normally, but the bake and broil elements do not heat:**

1. Go to the back of the oven control and measure the voltage drop between terminals L1 and P4. If the meter reads zero and if the display is illuminated, the wire between terminal IN and the range terminal block is open. If the meter reads line to line voltage (240 VAC) go to step 2.
2. Program the oven for bake and measure the voltage drop between terminals BAKE and P7. If the meter reads zero the control is defective. If the meter reads line to line voltage (240VAC) the bake element or the wiring to the bake element is defective. Go to step 3.
3. Program the oven for broil and measure the voltage drop between terminals BROIL and P7. If the meter reads zero the control is defective. If the meter reads line to line voltage (240VAC) the broil element or the wiring to the broil element is defective.

If the control appears to be operating normally, the broil element heats, but the bake element does not heat:

1. Program the oven for bake, go to the back of the oven control and measure the voltage drop between terminals BAKE and P7. If the meter reads zero the control is defective. If the meter reads line to line voltage (240 VAC) the bake element or the wiring to the bake element is defective. Go to step 2.
2. Remove the back from the range to gain access to the terminals of the bake element. Program the oven control for bake and measure the voltage drop across the terminals of the bake element. If the meter reads line to line voltage (240VAC) the element is defective. If the meter reads zero the wiring to the element is open.

If the control appears to be operating normally, the bake element heats, but the broil element does not heat:

1. Program the oven for broil, go to the back of the oven control and measure the voltage drop between terminals BROIL and P7. If the meter reads zero

the control is defective. If the meter reads line to line voltage (240 VAC) the broil element or the wiring to the broil element is defective. Go to step 2.

2. Remove the back from the range to gain access to the terminals of the broil element. Program the oven control for broil and measure the voltage drop across the terminals of the broil element. If the meter reads line to line voltage (240VAC) the element is defective. If the meter reads zero the wiring to the element is open.

Oven door does not lock when the oven is programmed for clean:

1. Remove power from the range and go to the back of the oven control. Remove the 15 pin plug and with the oven door closed measure the resistance between pins 5 and 6 in the plug. If the meter reads around 2400 Ohms the control is defective. If the meter reads open go to step 2.
2. Remove the rear cover from the range and measure the resistance of the lock motor. If the meter reads open the motor is defective. If the meter reads around 2400 Ohms go to step 3.
3. Remove the right-hand bodyside and measure the resistance between terminals NO and C of the door switch with the door closed. If the meter reads infinity the door switch is defective. If the meter reads zero go to step 4.
4. Measure the resistance between pins 9 and 11 of the 15 pin plug. If the meter reads infinity the lock switch is defective. If the meter reads zero replace the control.

Oven door locks when the oven is programmed for clean but the oven does not heat:

1. If the oven operates normally in bake, replace the control.

Lock motor runs continuously:

1. With the door in the unlock position, remove power from the range. Go to the back of the control and disconnect the 15 pin plug from the control. With an Ohmmeter measure the resistance between pins 9 and 10 of the 15 pin plug (not on the EOC). If the meter reads zero the lock switch or the wiring to the lock switch is defective. If the meter reads infinity go to step 2.
2. Depress the arm of the lock switch, and measure the resistance between pins 9 and 10 of the 15 pin

plug. If the meter reads infinity the lock switch or the wiring to the lock switch is defective. If the meter reads zero the control is defective.

Door latch is partly closed with door open, cannot close door:

1. Program the oven for self-clean, remove the right-hand side panel and hold the oven door switch closed, the latch mechanism should rotate close. After 30 seconds touch clear and the latch mechanism should rotate open.

Fan in oven does not run when speed bake switch is turned on:

1. Program the oven for clean. If the door does not lock check the door switch. If the door locks touch clear and allow the door to unlock and go to step 2.
2. Go to the back of the speed bake switch, with the switch in the on position measure the voltage drop between each terminal of the switch and neutral. If no voltage is shown from either terminal the wire between the P7 terminal of the oven control and the switch is open. If voltage is present on one terminal but not the other the switch is defective. If voltage is present on both terminals the motor or the wiring to the motor is defective.

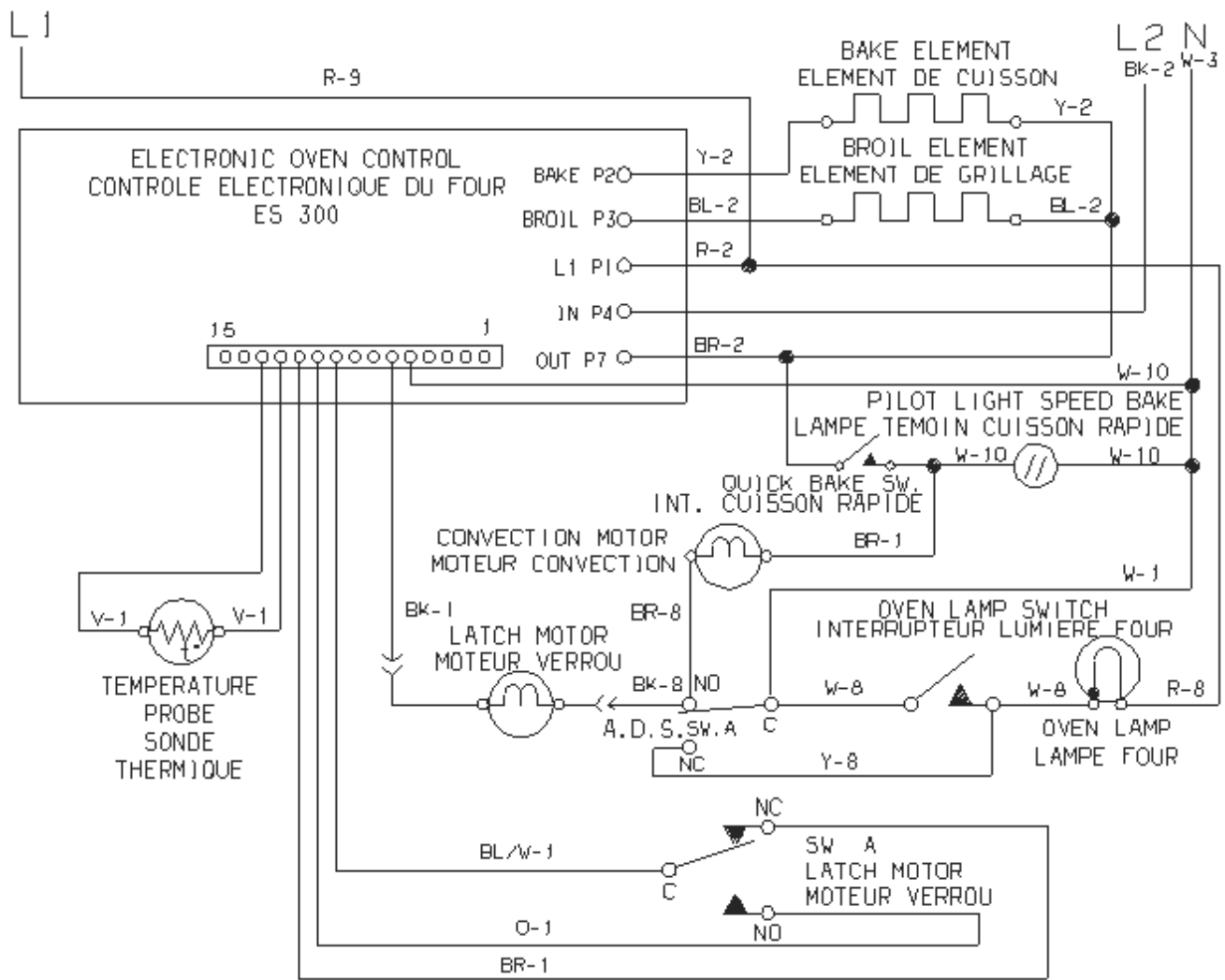

SAMPLE SCHEMATIC FOR THE ES 300 CONTROL SYSTEM

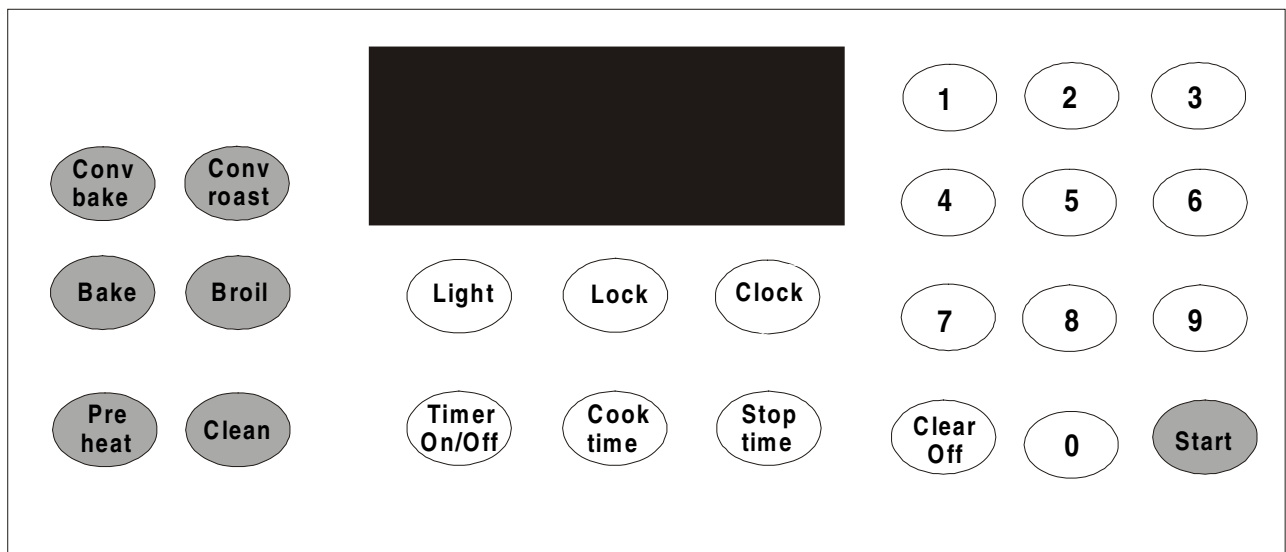

The ES 400 Electronic Oven Control System:

The ES 400 electronic oven control system is used to control ovens on self-cleaning model ranges with the convection feature.

How to program the ES 400:

The oven can be programmed to: Bake, Time Bake, Broil, Convection Bake, Convection Roast, Self-Clean, Continuous Bake, and set for Oven Lockout.

Clock:

The clock may be set for 12 or 24 hour time of day operation. The clock has been preset at the factory for 12 hour operation. When the range is first plugged in or when the power supply to the range has been interrupted, the timer in the display will flash and **PF** (power failure) will appear in the display.

To set the clock:

1. Press **Clock**. "CLO" will appear in the display.
2. Example for 1:30. Press the numbers 1 3 0 to set the time of day to 1:30. "CLO" will disappear after 4 seconds and the clock will start. Or you may press **Start**. "CLO" will disappear and the clock will start.

Changing between 12 or 24 hour time of day display:

1. Press and hold **Clock** for 6 seconds and a beep will sound.
2. The display will show **12:00** to indicate the 12 hour time of day operation is active.

3. Press **Clean** to toggle between the 12 and 24 hour time of day display. The display will show either **12:00** or **24:00**.
4. Press **Start** to accept the change or press **Clear/Off** to reject the change.
5. Reset the correct time as described in

Please note that if the 24 hour time of day mode was chosen, the clock will now display time from 0:00 through 24:00 hours.

Continuous bake or 12 hour energy saving:

The oven control has a factory preset built-in 12 hour energy saving feature that will shut off the oven if the oven control is left on for more than 11 hours and 59 minutes. The oven can be programmed to override this feature for continuous baking.

To set the control for continuous bake or 12 hour energy saving:

1. Press and hold **Timer On/Off** for 7 seconds, ":-:" or "12" will appear in the display and the control will beep once.
2. Press **Clean** to toggle between the 12 hour energy saving and continuous bake features.

NOTE: "12" in the display indicates the control is set for the 12 hour energy saving mode and ":-:" indicates the control is set for the continuous bake feature.

3. Press **Start** to accept the change or press **Clear/Off** to reject the change.

Minute timer:

The minute timer serves as an extra timer in the kitchen that will beep when the set time has run out. It does not start or stop cooking. The minute timer can be used during any of the other oven functions. The minute timer can be set for any amount of time from 1 minute to 11 hours 59 minutes in the 12 or 24 hour modes.

To set the minute timer:

1. Press **Timer On/Off**, “0:00” and “TIMER” will flash in the display.
2. Push the number pads to set the desired time in the display. Press **Start**, the time will begin to count down and “TIMER” will glow in the display.
Note: If **Start** is not pressed the timer will return to the time of day.
3. When the set time has run out, “END” will show in the display and beep 3 times, every 60 seconds, until **Timer On/Off** is pressed.

To change the minute timer while it is in use:

1. Press **Timer On/Off** 2 times and enter the new time using the number pads. Then press **Start** to start with the new time.

To cancel the minute timer before the set time has run out:

1. Press and hold **Timer On/Off**. The display will return to the time of day.

Oven lockout feature:

The Oven Lockout feature prevents the oven from being accidentally turned on. It does not disable the clock, minute timer, surface elements or oven light switch.

To activate the oven lockout:

1. Press and hold **Lock** for three seconds.
2. After 3 seconds the lock icon light (🔒) will come on and “DOOR LOCKED” will flash in the display. Once the oven door is locked the “DOOR LOCKED” indicator will quit flashing and remain on along with the lock icon light.

To reactivate oven operation:

1. Press and hold **Lock** for three seconds. A beep

will sound and the lock icon light (🔒) will clear and the time will be shown. The “DOOR LOCKED” will continue to flash until the oven door has completely unlocked.

2. The oven control may then be programmed for all operations.

Temperature display - Fahrenheit or Celcius:

The oven control can be programmed to display temperatures in Fahrenheit or Celsius. The range has been preset at the factory to display in Fahrenheit.

To change the temperature from °F to °C or from °C to °F:

1. Identify which display your control is set for now. To tell if your range is set for Fahrenheit or Celsius press **Broil** and hold for 7 seconds. A beep will then sound. If “F” appears in the display it is set to show temperatures in Fahrenheit. If “C” appears in the display it is set to show temperatures in Celsius.
2. Press **Clean** to toggle between the Fahrenheit to Celsius display mode. The display will show either “F” (Fig. 4) or “C”.
3. Press **Start** to accept the change or press **Clear Off** to reject the change.

Silent control operation:

The silent operation feature allows the control to be operated without sounds or beeps whenever necessary. If desired the control can be programmed for silent operation and later returned to operating with all the normal sounds and beeps.

To change control from normal sound operation to silent control operation:

1. Identify which sound operation your control is set for now. To tell if your range is set for normal or silent operation press and hold **Stop Time** for 7 seconds. “DELAY” will flash in the display. If “:SP” appears, the control will operate with normal sounds and beeps. If “:—” appears, the control is in the silent operation mode.
2. Press **Clean** to toggle between the normal sound operation and silent operation mode. The display will show either “:SP” or “:—”.
3. Press **Start** to accept the change or press **Clear Off** to reject the change.

Preheat:

The preheat mode will bring the oven up to temperature and then beep to let you know when to add your food. Preheating the oven is recommended when baking breads and cakes. The oven can be programmed to preheat at any temperature from 170° F to 550° F.

To set the preheat temperature:

1. Arrange oven racks.
2. Press **Preheat**. “—°” and “BAKE” will show in the display.
3. Press the numbers to set the temperature you want the oven to attain in preheat. The set temperature and “BAKE” will show in the display.
4. Press **Start**. “PRE” and “BAKE” will show in the display as the oven heats and reaches the set temperature.

NOTE: After the oven has reached the desired temperature the control will beep and the “PRE” light will turn off and oven temperature will be displayed. If the beep was missed, a quick glance at the display with the “PRE” missing and the oven temperature shown in its place, is a good way to check that the oven has reached the preheat temperature. Once the oven has preheated, you may place food in the oven immediately. The “BAKE” light will stay on.

5. Press **Clear Off** when baking is complete or to cancel preheat.

To change the preheat temperature while the oven is preheating:

1. While preheating, press **Preheat**. “—°” and “BAKE” will show in the display.
2. Enter the new preheat temperature. Press the numbers for the new set temperature. The new set temperature and “BAKE” will show in the display.
3. Press **Preheat**. “PRE” and “BAKE” will show in the display as the oven heats and reaches the new set temperature.
4. When baking is complete press **Clear Off**.

Bake:

Use this mode when preheating is not necessary, such as when roasting or cooking casseroles. The oven can

be programmed to bake at any temperature from 170° F to 550° F (the sample below is for 350° F).

To set the bake temperature:

1. Arrange oven racks and place food in oven.
2. Press **Bake**, “—°” will show in the display.
3. Press 3 5 0 . “350°” will flash and “BAKE” will show in the display.
4. Press **Start**. “BAKE” and “350°” oven temperature will show in the display.
5. Press **Clear Off** to stop baking or to cancel bake at any time.

To change the bake temperature:

(example 350° F to 425° F)

1. After the oven has already been set to bake at 350° F and should the temperature need to be changed to 425° F, press **Bake** and “—°” will show in the display. Then press 4 2 5 . “425°” and “BAKE” will show in the display.
3. Press **Start**. “BAKE” and the new oven temperature will show in the display.

Timed bake:

COOK TIME or **STOP TIME** control the Time Bake operation. The automatic timer will turn the oven off at the time you select in advance.

CAUTION: Use caution with the Timed Bake feature to cook cured or frozen meats and most fruits and vegetables. Foods that can easily spoil such as milk, eggs, fish, meat or poultry, should be chilled in the refrigerator first. Even when chilled, they should not stand in the oven for more than 1 hour before cooking begins, and should be removed promptly when cooking is completed. Eating spoiled food can result in sickness from food poisoning.

To program the oven to begin baking immediately and to shut off automatically:

(example to bake at 350° F for 50 minutes)

1. Be sure that the clock shows the correct time of day.
2. Arrange oven rack(s) and, if roasting or cooking a casserole, place the food in the oven.
3. Press **Bake**, “—°” will show in the display.

4. Press 3 5 0 . “350°” will flash and “BAKE” will show in the display.
5. Press **Start** . “350°” and “BAKE” will show in the display.
6. Press **Cook Time**. “TIMED” will flash; “BAKE”, “00:00” and “350°” will show in the display.
7. Enter the desired baking time using the number pads pressing 5 0 . “TIMED” will flash and “BAKE”, “00:50” and “350°” will show in the display.

NOTE: Baking time can be set for any amount of time from 1 minute to 11 hours and 59 minutes with a 12 hour display mode and from 1 minute to 23 hours and 59 minutes with a 24 hour display mode.

8. Press **Start** . Both the “TIMED” and “BAKE” icons will remain on in the display. Once Timed Bake has started, the current time will return in the display.

NOTE: Once Timed Bake is activated, press **Cook Time** to display the cook time remaining in the Timed Bake mode.

9. Press **Clear Off** when baking is complete or at any time to cancel the Timed Bake mode.

Delay time bake - cook time and stop time:

The automatic timer will turn the oven **on and off** at the time you select in advance.

To program the oven for a delayed start time and to shutoff automatically:

(example bake at 350° F for 50 minutes finishing at 5:30)

1. Be sure that the clock shows the correct time of day.
2. Arrange oven rack(s) and, if roasting or cooking a casserole, place the food in the oven.
3. Press **Bake**, “—°” will show in the display.
4. Press 3 5 0 . “350°” will flash and “BAKE” will show in the display.
5. Press **Start** . “350°” and “BAKE” will show in the display.
6. Press **Cook Time**. “TIMED” will flash; “BAKE”, “00:00” and “350°” will show in the display.
7. Enter the desired baking time using the number

pads pressing 5 0 . “TIMED” will flash and “BAKE”, “00:50” and “350°” will show in the display.

NOTE: Baking time can be set for any amount of time from 1 minute to 11 hours and 59 minutes with a 12 hour display mode and from 1 minute to 23 hours and 59 minutes with a 24 hour display mode.

8. Press **Start**. “TIMED, BAKE” and “350°” will appear.
9. Press **StopTime**. Enter the desired stop time using the number pads 5 3 0 .
10. Press **Start**. Once Timed Delay Bake has started, the set oven temperature will disappear. “TIMED”, “DELAY” and “BAKE” and the current time of time will show in the display.

NOTE: Once Timed Bake is activated, press **Cook Time** to display the cook time remaining in the Timed Bake mode. Press **Clear Off** when baking has completed or at any time to cancel the delayed timed bake mode.

When the set bake time runs out:

1. “End” will appear in the display window and the oven will shut off automatically.
2. The control will beep 3 times. The control will continue to beep 3 times each minute until **Clear Off** is pushed.

To broil:

When broiling, heat radiates downward from the oven broil element for even coverage. The broil feature is preset to start broiling at 550° F. However, the broil feature temperature may be set between 400° F and 550° F.

CAUTION: DO NOT use the pan without its insert.

CAUTION: DO NOT cover the insert with foil. The exposed grease could ignite. Should an oven fire occur, leave the oven door closed and turn off the oven. If the fire continues, throw baking soda on the fire or use a fire extinguisher. DO NOT put water or flour on the fire. Flour may be explosive and water can cause a grease fire to spread and cause personal injury.

To set the oven to broil: (example 550° F)

1. Place the insert on the broiler pan, then place the food on the insert. **DO NOT** use the broiler pan

without the insert. **DO NOT** cover the broiler insert with aluminum foil. The exposed fat could ignite.

2. Arrange oven rack and place the pan on the oven rack. Be sure to center the broiler pan directly under the broil burner. Open the oven door to the broil stop position.
3. Press **Broil**. “**BROIL**” will flash and “**550**” appear in the display.
4. Press **Start**. The oven will begin to broil. “**BROIL**” and “**550**” appear in the display.
5. Broil on one side until food is browned; turn and cook on the second side. Season and serve.

NOTE: Always pull the rack out to the stop position before turning or removing food.

6. The “**BROIL**” icon in the display will stay on.
7. To cancel broiling or when broiling is complete press **Clear Off**.

Convection bake:

To set the convection bake feature:
(example 350° F)

1. Arrange oven racks and place food in oven.
2. Press **Conv Bake**. “**CONV BAKE**” icon will flash and “—°” will show in the display.
3. Press 3 5 0 . “**CONV BAKE**” icon will flash and “**350**” will show in the display.
4. Press **Start**. The “**CONV BAKE**” icon will remain on. Also the “**350**” oven temperature and the oven icon will show in the display.

NOTE: The convection fan will come on a short time after the oven has been set for convection bake. The oven icon display will begin rotating indicating that the convection fan is operating.

5. Press **Clear Off** to stop baking or to cancel bake at any time.

Convection roast:

The convection roast feature is used when cooking with meat. This feature has been designed to give optimum cooking performance for roasting meats.

To set the convection roast feature:(example 350° F)

1. Arrange interior oven racks and place food in oven.
2. Press **Conv roast** . “**CONV**” will flash and “—°” will be displayed.
3. Press 3 5 0 . “**CONV**” will flash and “**350**” will appear in the display.
4. Press **Start** . “**CONV**” and “**350**” will appear in the display. The convection fan icon will come on.
5. Press **Clear Off** to stop convection roast, or to cancel convection roast at any time.

Self-clean cycle:

When planning to use the oven directly after a self-clean cycle remember to allow time for the oven to cool down and the oven door to unlock. This normally takes about one hour. Therefore, a 3 hour self-clean cycle will actually take about 4 hours to complete.

It is recommended to use a 2 hour self-clean cycle for **light soils**, a 3 hour cycle for **average soils**, and a 4 hour cycle for **heavy soils** (to assure satisfactory results).

CAUTION: During the self-cleaning cycle, the outside of the range can become very hot to the touch. DO NOT leave small children unattended near the appliance; they may be burned if they touch the hot oven door surfaces.

CAUTION: DO NOT force the oven door open. This can damage the automatic door locking system. Use care when opening the oven door after the self-cleaning cycle. Stand to the side of the oven when opening the door to allow hot air or steam to escape. The oven may still be very hot.

To set the controls for the self-cleaning cycle to start immediately and shut off automatically:

1. Be sure the clock shows the correct time of day and the oven door is closed.
2. Press **Clean**. “**CLEAN**” will flash and “**3:00**” will show in the display. If a 2 or 4 hour clean is desired use the number pads to enter the time. Set the cleaning time based on the amount of soil you have—light, average or heavy.
3. Press **Start**. The “**DOOR LOCKED**” icon will flash; “**CLEAN**” icon and the letters “**CLN**” will remain on in the display.
4. As soon as the controls are set, the motor driven

oven door lock will begin to close automatically and once the door has been locked the “**DOOR LOCKED**” indicator light will quit flashing and remain on. Also the oven icon will show in the display.

NOTE: It takes about 15 seconds for the oven door lock to close.

When the self-clean cycle is completed:

1. Only the time of day and the “**DOOR LOCKED**” icon will remain in the display.
2. Once the oven has cooled down for approximately 1 HOUR, and the word “**DOOR LOCKED**” shown in the display has gone out, the oven door can then be carefully opened.

Stopping or interrupting a self-cleaning cycle:

If it becomes necessary to stop or interrupt a self-cleaning cycle due to excessive smoke or fire in the oven:

1. Press **Clear Off**.
2. Once the oven has cooled down for approximately 1 HOUR and the “**DOOR LOCKED**” icon is no longer displayed, then the oven door may be carefully opened.

How the ES 400 operates:

CAUTION: NEVER ATTEMPT TO REMOVE EITHER THE BAKE OR BROIL ELEMENT WITHOUT DISCONNECTING ELECTRICAL POWER FROM THE RANGE. ELECTRICAL POWER IS CONNECTED TO THE ELEMENTS WHENEVER ELECTRICAL POWER IS CONNECTED TO THE RANGE.

The ES 400 electronic oven control system is made up of three parts that control the bake and broil elements, convection fan and element, oven light, and the locking of the door in clean.

1. Electronic oven control.
2. Oven temperature sensor.
3. Oven door lock mechanism.

Preheat:

When the preheat pad is touched and a temperature is entered with the number pads, the bake relay on the board closes, and connects one side of the line to the bake element. “PRE” and “BAKE” appear in the display. After the first cycle “PRE” disappears and the oven operates as in normal bake.

Bake:

When the bake pad is touched, and a temperature is entered with the number pads, the bake relay on the board closes, and connects one side of the line to the bake element. “BAKE” appears in the display. In the tip of the oven sensor is a positive thermistor that increases in resistance as the oven temperature increases. The EOC microprocessor reads the resistance of the oven sensor, and compares it with the programmed temperature set into the control. When the resistance of the oven sensor indicates temperature in the oven is about 10 degrees above the programmed temperature, the microprocessor opens the relay, which removes power from one side of the element. When power is removed from the element the oven temperature begins to lower. As the oven temperature lowers, the resistance of the oven sensor decreases. When the oven drops to about 10 degrees below the programmed temperature, the resistance of the sensor tells the microprocessor to close the relay contacts, and once again provide power to the element. After the first cycle and whenever the oven calls for heat, the EOC cycles the broil element on for seven seconds and then the bake element on for fifty three seconds out of every minute. This provides top heat during the bake cycle. The two elements are never on at the same time.

NOTE: Oven controls may have a temperature swing of more or less than 20 degrees. The important thing is the average temperature in the oven. The average temperature in the center of the oven should be within 10 degrees of the programmed temperature.

Time bake:

The time bake function allows the oven to be programmed to stop bake at a set time, or to delay the start and stop baking at a set time. The stop time cannot be set for more than 11 hours and 59 minutes ahead of the time of day.

Convection bake:

When the convection bake pad is touched and a temperature is set, two things happen that do not happen in normal bake. The EOC automatically raises the oven temperature 15° F above the temperature that was manually set in the control. If the oven door is closed, the convection relay on the EOC closes, providing line to neutral voltage to the convection fan motor and the convection assist element. This relay remains closed until the program is canceled or is interrupted by the opening of the oven door. If interrupted by the opening of the oven door, the relay will automatically close when the door is closed.

Convection roast:

Convection roast operates the same as convection bake except the control does not operate above the set temperature and the temperature differential is larger.

Broil:

When the broil pad is touched, and a temperature is entered with the numbers between 400° F and 550° F (usually 550° F), the broil relay on the board closes, and connects one side of the line to the broil element. In the tip of the oven sensor is a positive thermistor that increases in resistance as the oven temperature increases. The EOC microprocessor reads the resistance of the oven sensor and compares it with the programmed temperature set into the control. Usually you do not want the broil element to cycle so the oven door is opened to the broil stop position. If the door is not opened the broil element will cycle when the set temperature is reached.

Clean:

With the oven door closed, contacts COM to NO of the oven door switch close. Then when the clean pad is touched and a clean time is set the door lock relay on the electronic oven control closes providing line to neutral voltage (120 VAC) to the lock motor. The lock motor starts to rotate, closing the contacts of the door lock switch. When the motor rotates one half turn the contacts of the door lock switch reopen sending a signal to the EOC that the door is locked, and to open the contacts of the lock relay. The lock indicator light then glows steady and the EOC closes the bake relay providing power to the bake element. The clean temperature is preset into the EOC at around 850° F. It takes about 45 minutes for the oven to reach 850° F. When the temperature is reached the control cycles the bake element off and on to maintain the temperature until the clean time is completed. When the clean time is completed the EOC removes power from the bake element and the oven cools down. When the temperature in the oven goes below 500° F the control closes the contacts of the lock relay. The lock motor then turns 180 degrees closing and reopening the contacts of the lock switch and unlocking the door. The open contacts of the lock switch tells the control that the door is unlocked and to open the contacts of the lock relay and turn the lock indicator light off.

Calibration:

To check oven calibration:

1. Place a thermometer or thermocouple in the center of the oven.
2. Program the oven for bake and the temperature to

350° F. Allow the oven to cycle three times.

3. Average the highest and lowest reading. The average should be within 10° F of 350° F.

To change the calibration:

To adjust the oven temperature higher:

1. Press the **Bake pad** for 6 seconds. "0" will appear in the display.

NOTE: If any numbers other than "0" appear in the display, the control has been previously calibrated in the field. (temperature can be changed \pm 35)

2. To increase the temperature, use the number pads to enter the desired change. The temperature may be increased up to 35° F.
3. Press **Start** to accept the temperature change and the display will return to the time of day. Press **Clear Off** to reject the change if necessary.

To adjust the oven temperature lower:

1. Press the **Bake pad** for 6 seconds. "0" will appear in the display.
2. To decrease the temperature, use the number pads to enter the desired change and then press **Clean**. The temperature may be decrease up to 35° F. (NOTE: Pressing **CLEAN** allows the entry of negative degree change.)
3. Press **Start** to accept the temperature change and the display will return to the time of day. Press **Clear Off** to reject the change if necessary.

Troubleshooting:

The ES 400 has some self diagnostics built into the microprocessor to help in troubleshooting the system. When a failure occurs one of three codes will appear in the display window: F1, F3, or F9

F1 code:

An F1 indicates a malfunction in the EOC itself, and the control should be replaced.

F3 code:

An F3 indicates a defective sensor, electronic oven control, thermal circuit breaker or the wiring in between.

To determine which part is defective:

1. Disconnect the fifteen pin plug from the back of the oven control that connects the sensor to the oven control.
2. With an Ohmmeter, measure the resistance between pins 14 and 15 in the plug (not on the control board). If the meter reads around value of the oven temperature sensor resistance chart shown below, the oven control is defective. If the meter reads less than 800 Ohms or more than 3000 Ohms, go to step 3.

RTD	SCALE
Temperature Degrees F.	Resistance (Ohms)
32 +/- 1.9	1000 +/- 4.0
75 +/- 2.5	1091 +/- 5.3
250 +/- 4.4	1453 +/- 8.9
350 +/- 5.4	1654 +/- 10.8
450 +/- 6.9	1852 +/- 13.5
550 +/- 8.2	2047 +/- 15.8
650 +/- 9.6	2237 +/- 18.5
900 +/- 13.6	2697 +/- 24.4

3. Disconnect the harness from the oven sensor and measure the resistance of the oven sensor. If the meter reads less than 800 Ohms or more than 3000 Ohms, the oven sensor is defective. If the reading is correct with the chart go to step 4.
4. Remove the rear cover of the range and connect an Ohm meter between the terminals of the thermal circuit breaker. If the meter reads infinity the circuit breaker is defective. If the meter reads zero the wiring is defective.

F9 code:

An F9 code indicates the control has detected a problem with the motor door latch assembly. Check the contacts of the lock switch, wiring to the lock motor assembly, and the lock motor.

Control will not program:

If the EOC will not program check for an open sensor circuit. If the sensor circuit is good replace the control.

Time bake does not operate:

If the normal bake feature operates but the time bake feature does not operate, check to be sure it is being programmed correctly. If it is being programmed correctly, replace the control.

Convection bake and convection roast:

Neither the fan motor or the assist element operates:

1. Remove power from range. Go to the back of the electronic oven control and disconnect the 15 pin plug. With the oven door closed, measure the resistance between pins 10 and 12 of the 15 pin plug (in the plug). If the meter reads open, check the door switch and the wiring from the electronic oven control to the door switch. If the meter reads zero go to step 2.
2. Measure the resistance between pins 5 and 7. If the meter reads around 40 Ohms the control is defective. If the meter reads infinity either the wiring to the fan motor and element is open or both the fan motor and the element are defective.

If either convection bake or convection roast operate normally but the other does not:

1. The EOC is defective.

Fan motor does not operate:

1. If the convection element is heating then the fan motor itself or the wiring to the fan motor is defective. Also check for a blocked fan blade.

Convection element does not operate:

1. If the convection fan is operating then the element itself, the diode, or the wiring to the element is defective.

Control does not operate in preheat:

1. If the oven operates in bake but not preheat, the EOC is defective.

Blank display:

1. With the range connected to electrical power, go to the back of the control and measure the voltage drop between terminal L1 and neutral. If the meter reads line to neutral voltage (120 VAC), the control is defective. If the meter reads zero the wiring in the range is defective.

Bake element does not heat:

1. With the range connected to electrical power, go to the back of the oven control and measure the voltage drop between terminals BA and neutral with the control not programmed (clock operating only). If the meter reads line to neutral (120 VAC) the control is defective. If the meter reads zero, the bake

element or the wiring to the bake element is defective. Go to step 2.

2. Remove the back from the range to gain access to the terminals of the bake element. Program the oven control for bake and measure the voltage drop across the terminals of the bake element. If the meter reads line to line voltage (240 VAC) the element is defective. If the meter reads zero the wiring to the element is open.

Broil element does not heat:

1. With the range connected to electrical power, go to the back of the oven control and measure the voltage drop between terminals BR and neutral with the control not programmed (clock operating only). If the meter reads line to neutral (120 VAC) the control is defective. If the meter reads zero the broil element or the wiring to the broil element is defective. Go to step 2.
2. Remove the back from the range to gain access to the terminals of the broil element. Program the oven control for broil and measure the voltage drop across the terminals of the broil element. If the meter reads line to line voltage (240 VAC) the element is defective. If the meter reads zero the wiring to the element is open.

Oven door does not lock when the oven is programmed for clean:

1. Remove power from the range, go the back of the control and disconnect the 15 pin plug. Measure the resistance between pins 5 and 6 of the 15 pin plug (in the plug). If the meter reads infinity, the lock motor or the wiring to the lock motor is defective. If the meter reads around 2400 ohms go to step 2.
2. Measure the resistance between pins 10 and 12 of the 15 pin plug with the oven door closed. If the meter reads infinity, the door switch or the wiring to the door light switch is defective. If the meter reads zero go to step 3.
3. Measure the resistance between pins 10 and 13 of the 15 pin plug. If the meter reads infinity the lock switch or the wiring to the lock switch is defective. If the meter reads zero the control is defective.

Oven door locks but the oven does not heat:

1. If the oven operates in normal bake, program the oven for clean and allow the door to lock. Disconnect the 15 pin plug from the oven control and measure the resistance between pins 10 and

11 in the plug. If the meter reads infinity the latch switch or the wiring to the latch is defective. If the meter reads zero the control is defective.

Door latch is partly closed with door open:

1. Program the oven for self-clean, remove the right-hand bodyside, and hold the door switch closed for 30 seconds. Touch cancel and hold door switch in for 30 seconds. The lock motor should lock and unlock the door.

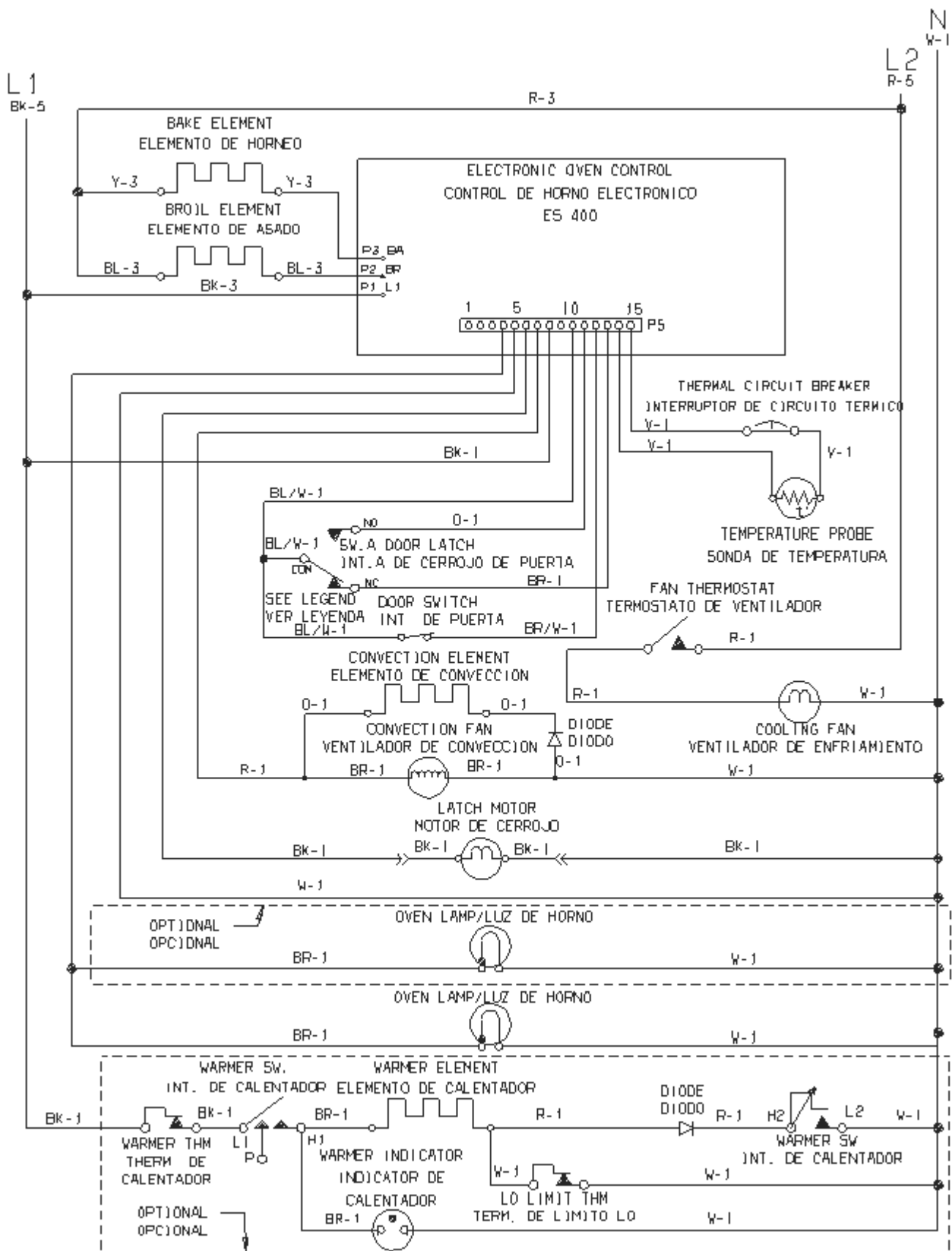

SAMPLE SCHEMATIC FOR THE ES 400 CONTROL SYSTEM

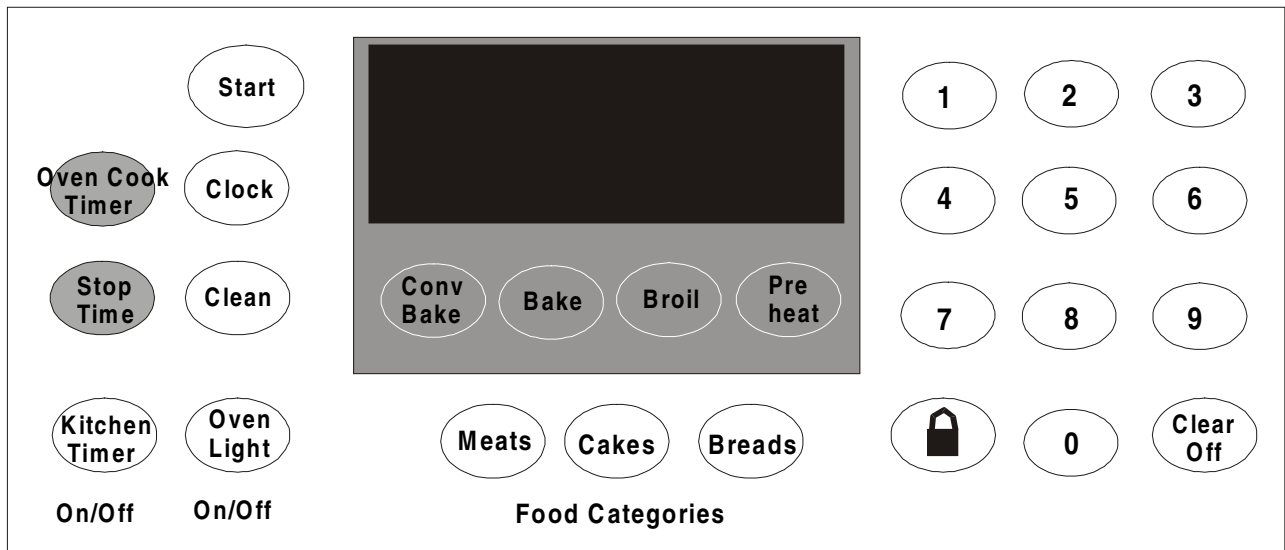

The ES 450 Electronic Oven Control System:

The ES 450 electronic oven control system is used to control ovens on self-cleaning model ranges that have the convection and pre-programmed features.

How to program the ES 450:

The oven can be programmed to: Bake, Time Bake, Broil, Convection Bake, Self-Clean, Continuous Bake, Preprogram Functions, and set for Oven Lockout.

Clock:

The clock may be set for 12 or 24 hour time of day operation. The clock has been preset at the factory for 12 hour operation. When the range is first plugged in or when the power supply to the range has been interrupted, the timer in the display will flash and **PF** (power failure) will appear in the display.

To set the clock:

1. Press **Clock**. "CLO" will appear in the display.
2. Example for 1:30. Press the numbers 1 3 0 to set the time of day to 1:30. "CLO" will disappear after 4 seconds and the clock will start. Or you may press **Start**. "CLO" will disappear and the clock will start.

Changing between 12 or 24 hour time of day display:

1. Press and hold **Clock** for 6 seconds and a beep will sound.
2. The display will show **12:00** to indicate the 12 hour time of day operation is active.

3. Press **Clean** to toggle between the 12 and 24 hour time of day display. The display will show either **12:00** or **24:00**.
4. Press **Start** to accept the change or press **Clear/Off** to reject the change.
5. Reset the correct time as described in **To set the clock**.

Please note that if the 24 hour time of day mode was chosen, the clock will now display time from 0:00 through 24:00 hours.

Continuous bake or 12 hour energy saving:

The oven control has a factory preset built-in 12 hour energy saving feature that will shut off the oven if the oven control is left on for more than 11 hours and 59 minutes. The oven can be programmed to override this feature for continuous baking.

To set the control for continuous bake or 12 hour energy saving:

1. Press and hold **Timer On/Off** for 7 seconds, ":-" or "12" will appear in the display and the control will beep once.
2. Press **Clean** to toggle between the 12 hour energy saving and continuous bake features.

NOTE: "12" in the display indicates the control is set for the 12 hour energy saving mode and ":-" indicates the control is set for the continuous bake feature.

3. Press **Start** to accept the change or press **Clear/Off** to reject the change.

Minute timer:

The minute timer serves as an extra timer in the kitchen that will beep when the set time has run out. It does not start or stop cooking. The minute timer can be used during any of the other oven functions. The minute timer can be set for any amount of time from 1 minute to 11 hours 59 minutes in the 12 or 24 hour modes.

To set the minute timer:

1. Press **Timer On/Off**, “0:00” and “TIMER” will flash in the display.
2. Push the number pads to set the desired time in the display. Press **Start**, the time will begin to count down and “TIMER” will glow in the display. Note: If **Start** is not pressed the timer will return to the time of day.
3. When the set time has run out, “END” will show in the display and beep 3 times, every 60 seconds, until **Timer On/Off** is pressed.

To change the minute timer while it is in use:

1. Press **Timer On/Off** 2 times and enter the new time using the number pads. Then press **Start** to start with the new time.

To cancel the minute timer before the set time has run out:

1. Press and hold **Timer On/Off**. The display will return to the time of day.

Oven lockout feature:

The Oven Lockout feature prevents the oven from being accidentally turned on. It does not disable the clock, minute timer, oven light, or surface elements.

To activate the oven lockout:

1. Press and hold **Lock** for three seconds.
2. After 3 seconds the lock icon light (🔒) will come on and “DOOR LOCKED” will flash in the display. Once the oven door is locked the “DOOR LOCKED” indicator will quit flashing and remain on along with the lock icon light.

To reactivate oven operation:

1. Press and hold **Lock** for three seconds. A beep

will sound and the lock icon light (🔒) will clear and the time will be shown. The “DOOR LOCKED” will continue to flash until the oven door has completely unlocked.

2. The oven control may then be programmed for all operations.

Temperature display - Fahrenheit or Celsius:

The oven control can be programmed to display temperatures in Fahrenheit or Celsius. The range has been preset at the factory to display in Fahrenheit.

To change the temperature from °F to °C or from °C to °F:

1. Identify which display your control is set for now. To tell if your range is set for Fahrenheit or Celsius press **Broil** and hold for 7 seconds. A beep will then sound. If “F” appears in the display it is set to show temperatures in Fahrenheit. If “C” appears in the display it is set to show temperatures in Celsius.
2. Press **Clean** to toggle between the Fahrenheit to Celsius display mode. The display will show either “F” (Fig. 4) or “C”.
3. Press **Start** to accept the change or press **Clear Off** to reject the change.

Silent control operation:

The silent operation feature allows the control to be operated without sounds or beeps whenever necessary. If desired the control can be programmed for silent operation and later returned to operating with all the normal sounds and beeps.

To change control from normal sound operation to silent control operation:

1. Identify which sound operation your control is set for now. To tell if your range is set for normal or silent operation press and hold **Stop Time** for 7 seconds. “DELAY” will flash in the display. If “:SP” appears, the control will operate with normal sounds and beeps. If “:—” appears, the control is in the silent operation mode.
2. Press **Clean** to toggle between the normal sound operation and silent operation mode. The display will show either “:SP” or “:—”.
3. Press **Start** to accept the change or press **Clear Off** to reject the change.

Preheat:

The preheat mode will bring the oven up to temperature and then beep to let you know when to add your food. Preheating the oven is recommended when baking breads and cakes. The oven can be programmed to preheat at any temperature from 170° F to 550° F.

To set the preheat temperature:

1. Arrange oven racks.
2. Press **Preheat**. “—°” and “**BAKE**” will show in the display.
3. Press the numbers to set the temperature you want the oven to attain in preheat. The set temperature and “**BAKE**” will show in the display.
4. Press **Start**. “**PRE**” and “**BAKE**” will show in the display as the oven heats and reaches the set temperature.

NOTE: After the oven has reached the desired temperature the control will beep and the “**PRE**” light will turn off and oven temperature will be displayed. If the beep was missed, a quick glance at the display with the “**PRE**” missing and the oven temperature shown in its place, is a good way to check that the oven has reached the preheat temperature. Once the oven has preheated, you may place food in the oven immediately. The “**BAKE**” light will stay on.

5. Press **Clear Off** when baking is complete or to cancel preheat.

To change the preheat temperature while the oven is preheating:

1. While preheating, press **Preheat**. “—°” and “**BAKE**” will show in the display.
2. Enter the new preheat temperature. Press the numbers for the new set temperature. The new set temperature and “**BAKE**” will show in the display.
3. Press **Preheat**. “**PRE**” and “**BAKE**” will show in the display as the oven heats and reaches the new set temperature.
4. When baking is complete press **Clear Off**.

Bake:

Use this mode when preheating is not necessary, such

as when roasting or cooking casseroles. The oven can be programmed to bake at any temperature from 170° F to 550° F (the sample below is for 350° F).

To set the bake temperature:

1. Arrange oven racks and place food in oven.
2. Press **Bake**, “—°” will show in the display.
3. Press 3 5 0 . “**350°**” will flash and “**BAKE**” will show in the display.
4. Press **Start**. “**BAKE**” and “**350°**” oven temperature will show in the display.
5. Press **Clear Off** to stop baking or to cancel bake at any time.

To change the bake temperature:

(example 350° F to 425° F)

1. After the oven has already been set to bake at 350° F and should the temperature need to be changed to 425° F, press **Bake** and “—°” will show in the display. Then press 4 2 5 . “**425°**” and “**BAKE**” will show in the display.
3. Press **Start**. “**BAKE**” and the new oven temperature will show in the display.

Timed bake:

COOK TIME or **STOP TIME** control the Time Bake operation. The automatic timer will turn the oven off at the time you select in advance.

CAUTION: Use caution with the Timed Bake feature to cook cured or frozen meats and most fruits and vegetables. Foods that can easily spoil such as milk, eggs, fish, meat or poultry, should be chilled in the refrigerator first. Even when chilled, they should not stand in the oven for more than 1 hour before cooking begins, and should be removed promptly when cooking is completed. Eating spoiled food can result in sickness from food poisoning.

To program the oven to begin baking immediately and to shut off automatically:

(example to bake at 350° F for 50 minutes)

1. Be sure that the clock shows the correct time of day.
2. Arrange oven rack(s) and, if roasting or cooking a casserole, place the food in the oven.
3. Press **Bake**, “—°” will show in the display.

4. Press 3 5 0 . “350°” will flash and “BAKE” will show in the display.
5. Press **Start** . “350°” and “BAKE” will show in the display.
6. Press **Cook Time** . “TIMED” will flash; “BAKE”, “00:00” and “350°” will show in the display.
7. Enter the desired baking time using the number pads pressing 5 0 . “TIMED” will flash and “BAKE”, “00:50” and “350°” will show in the display.

NOTE: Baking time can be set for any amount of time from 1 minute to 11 hours and 59 minutes with a 12 hour display mode and from 1 minute to 23 hours and 59 minutes with a 24 hour display mode.

8. Press **Start** . Both the “TIMED” and “BAKE” icons will remain on in the display. Once Timed Bake has started, the current time will return in the display.

NOTE: Once Timed Bake is activated, press **Cook Time** to display the cook time remaining in the Timed Bake mode.

9. Press **Clear Off** when baking is complete or at any time to cancel the Timed Bake mode.

Delay time bake - cook time and stop time:

The automatic timer will turn the oven **on and off** at the time you select in advance.

To program the oven for a delayed start time and to shutoff automatically:

(example bake at 350° F for 50 minutes finishing at 5:30)

1. Be sure that the clock shows the correct time of day.
2. Arrange oven rack(s) and, if roasting or cooking a casserole, place the food in the oven.
3. Press **Bake** , “—” will show in the display.
4. Press 3 5 0 . “350°” will flash and “BAKE” will show in the display.
5. Press **Start** . “350°” and “BAKE “ will show in the display.
6. Press **Cook Time** . “TIMED” will flash; “BAKE”, “00:00” and “350°” will show in the display.
7. Enter the desired baking time using the number

pads pressing 5 0 . “TIMED” will flash and “BAKE”, “00:50” and “350°” will show in the display.

NOTE: Baking time can be set for any amount of time from 1 minute to 11 hours and 59 minutes with a 12 hour display mode and from 1 minute to 23 hours and 59 minutes with a 24 hour display mode.

8. Press **Start** . “TIMED, BAKE” and “350°” will appear.
9. Press **StopTime** . Enter the desired stop time using the number pads 5 3 0 .
10. Press **Start** . Once Timed Delay Bake has started, the set oven temperature will disappear. “TIMED”, “DELAY” and “BAKE” and the current time of time will show in the display.

NOTE: Once Timed Bake is activated, press **Cook Time** to display the cook time remaining in the Timed Bake mode. Press **Clear Off** when baking has completed or at any time to cancel the delayed timed bake mode.

When the set bake time runs out:

1. “End” will appear in the display window and the oven will shut off automatically.
2. The control will beep 3 times. The control will continue to beep 3 times each minute until **Clear Off** is pushed.

To broil:

When broiling, heat radiates downward from the oven broil element for even coverage. The broil feature is pre-set to start broiling at 550° F. However, the broil feature temperature may be set between 400° F and 550° F.

CAUTION: DO NOT use the pan without its insert.

CAUTION: DO NOT cover the insert with foil. The exposed grease could ignite. Should an oven fire occur, leave the oven door closed and turn off the oven. If the fire continues, throw baking soda on the fire or use a fire extinguisher. DO NOT put water or flour on the fire. Flour may be explosive and water can cause a grease fire to spread and cause personal injury.

To set the oven to broil: (example 550° F)

1. Place the insert on the broiler pan, then place the food on the insert. **DO NOT** use the broiler pan

without the insert. **DO NOT** cover the broiler insert with aluminum foil. The exposed fat could ignite.

2. Arrange oven rack and place the pan on the oven rack. Be sure to center the broiler pan directly under the broil burner. Open the oven door to the broil stop position.
3. Press **Broil**. “**BROIL**” will flash and “550” appear in the display.
4. Press **Start**. The oven will begin to broil. “**BROIL**” and “550°” appear in the display.
5. Broil on one side until food is browned; turn and cook on the second side. Season and serve.

NOTE: Always pull the rack out to the stop position before turning or removing food.

6. The “**BROIL**” icon in the display will stay.
7. To cancel broiling or when broiling is complete press **Clear Off**.

Convection bake:

To set the convection bake feature: (example 350° F)

1. Arrange oven racks and place food in oven.
2. Press **Conv Bake**. “**CONV BAKE**” icon will flash and “—°” will show in the display.
3. Press 3 5 0 . “**CONV BAKE**” icon will flash and “**350°**” will show in the display.
4. Press **Start**. The “**CONV BAKE**” icon will remain on. Also the “**350°**” oven temperature and the oven icon will show in the display.

NOTE: The convection fan will come on a short time after the oven has been set for convection bake. The oven icon display will begin rotating indicating that the convection fan is operating.

5. Press **Clear Off** to stop baking or to cancel bake at any time.

Setting food categories feature:

The **Meats**, **Cakes**, and **Breads** pads in the Food categories have been designed to give optimum performance for the foods selected in each category.

The **Meats** pad combines a cook cycle with the convection fan and element to roast meats and poultry. Pre-

heating is not necessary for meats and poultry. Heated air circulates around the food from all sides, sealing in juices and flavors. Foods are crispy brown on the outside while staying moist on the inside.

The **Cakes** pad provides a preheat with a gentle cycling of heat, giving cakes more volume and allowing delicate foods to cook more evenly. Cooktimes may need to be extended when baking 4 cake layers at one time.

The **Breads** pad adds a preheat feature to the bake cycle to thoroughly heat the oven from top to bottom to give more evenly browned food.

To set the food categories feature: (example cooking meats)

1. Arrange interior oven racks and place food in oven.
2. Press **Meats**. “**MEATS**” will flash and “—°” will be displayed.
3. Press 3 5 0 . “**MEATS**” will flash and “**350°**” will appear in the display.
4. Press **Start**. “**MEATS**” and “**350°**” will appear in the display and the convection fan icon will come on.

Press **Clear Off** to stop cooking meats, cakes, or breads, or to cancel at any time.

Self-clean cycle:

When planning to use the oven directly after a self-clean cycle remember to allow time for the oven to cool down and the oven door to unlock. This normally takes about one hour. Therefore, a 3 hour self-clean cycle will actually take about 4 hours to complete.

It is recommended to use a 2 hour self-clean cycle for **light soils**, a 3 hour cycle for **average soils**, and a 4 hour cycle for **heavy soils** (to assure satisfactory results).

CAUTION: During the self-cleaning cycle, the outside of the range can become very hot to the touch. DO NOT leave small children unattended near the appliance; they may be burned if they touch the hot oven door surfaces.

CAUTION: DO NOT force the oven door open. This can damage the automatic door locking system. Use care when opening the oven door after the self-cleaning cycle. Stand to the side of the oven when opening the door to allow hot air or steam to escape. The oven may still be very hot.

To set the controls for the self-cleaning cycle to start immediately and shut off automatically:

1. Be sure the clock shows the correct time of day and the oven door is closed.
2. Press **Clean**. "**CLEAN**" will flash and "**3:00**" will show in the display. If a 2 or 4 hour clean is desired use the number pads to enter the time. Set the cleaning time based on the amount of soil you have—light, average or heavy.
3. Press **Start**. The "**DOOR LOCKED**" icon will flash; "**CLEAN**" icon and the letters "**CLN**" will remain on in the display.
4. As soon as the controls are set, the motor driven oven door lock will begin to close automatically and once the door has been locked the "**DOOR LOCKED**" indicator light will quit flashing and remain on. Also the oven icon will show in the display. **NOTE:** It takes about 15 seconds for the oven door lock to close.

When the self-clean cycle is completed:

1. Only the time of day and the "**DOOR LOCKED**" icon will remain in the display.
2. Once the oven has cooled down for approximately 1 HOUR, and the word "**DOOR LOCKED**" shown in the display has gone out, the oven door can then be carefully opened.

Stopping or interrupting a self-cleaning cycle:

If it becomes necessary to stop or interrupt a self-cleaning cycle due to excessive smoke or fire in the oven:

1. Press **Clear Off**.
2. Once the oven has cooled down for approximately 1 HOUR and the "**DOOR LOCKED**" icon is no longer displayed, then the oven door may be carefully opened.

How the ES 450 works:

CAUTION: NEVER ATTEMPT TO REMOVE EITHER THE BAKE OR BROIL ELEMENT WITHOUT DISCONNECTING ELECTRICAL POWER FROM THE RANGE. ELECTRICAL POWER IS CONNECTED TO THE ELEMENTS WHENEVER ELECTRICAL POWER IS CONNECTED TO THE RANGE.

The ES 450 electronic oven control system is made up of three parts that control the bake and broil elements,

the convection fan in the oven, oven light and the locking of the door in clean.

1. Electronic oven control.
2. Oven temperature sensor.
3. Oven door lock mechanism.

Preheat:

When the preheat pad is touched and a temperature is entered with the number pads, the bake relay on the board closes, and connects one side of the line to the bake element. "**PRE**" and "**BAKE**" appear in the display. After the first cycle "**PRE**" disappears and the oven operates as in normal bake.

Bake:

When the bake pad is touched, and a temperature is entered with the number pads, the bake relay on the board closes, and connects one side of the line to the bake element. "**BAKE**" appears in the display. In the tip of the oven sensor is a positive thermistor that increases in resistance as the oven temperature increases. The EOC microprocessor reads the resistance of the oven sensor, and compares it with the programmed temperature set into the control. When the resistance of the oven sensor indicates temperature in the oven is about 10 degrees above the programmed temperature, the microprocessor opens the relay, which removes power from one side of the element. When power is removed from the element the oven temperature begins to lower. As the oven temperature lowers, the resistance of the oven sensor decreases. When the oven drops to about 10 degrees below the programmed temperature, the resistance of the sensor tells the microprocessor to close the relay contacts, and once again provide power to the element. After the first cycle and whenever the oven calls for heat, the EOC cycles the broil element on for seven seconds and then the bake element on for fifty three seconds out of every minute. This provides top heat during the bake cycle. The two elements are never on at the same time.

NOTE: Oven controls may have a temperature swing of more or less than 20 degrees. The important thing is the average temperature in the oven. The average temperature in the center of the oven should be within 10 degrees of the programmed temperature.

Time bake:

The time bake function allows the oven to be programmed to stop bake at a set time, or to delay the start and stop

baking at a set time. The stop time cannot be set for more than 11 hours and 59 minutes ahead of the time of day.

Convection bake:

When the convection bake pad is touched and a temperature is set, two things happen that do not happen in normal bake. The EOC automatically raises the oven temperature 15° F above the temperature that was manually set in the control. If the oven door is closed, the convection relay on the EOC closes, providing line to neutral voltage to the convection fan motor and the convection assist element. This relay remains closed until the program is canceled or is interrupted by the opening of the oven door. If interrupted by the opening of the oven door, the relay will automatically close when the door is closed.

Fixed Settings:

Meats:

When the meats pad is touched the oven operates with the convection fan and assist element at the set temperature.

Cakes:

When the cakes pad is touched the oven operates at a lower than set temperature with less temperature differential.

Breads:

When the breads pad is touched the oven operates at a higher than set temperature with more temperature differential. In addition, the broil element is on a higher percentage of the time.

Broil:

When the broil pad is touched, and a temperature is entered with the numbers between 400° F and 550° F (usually 550° F), the broil relay on the board closes, and connects one side of the line to the broil element. In the tip of the oven sensor is a positive thermistor that increases in resistance as the oven temperature increases. The EOC microprocessor reads the resistance of the oven sensor, and compares it with the programmed temperature set into the control. Usually you do not want the broil element to cycle so the oven door is opened to the broil stop position. If the door is not opened the broil element will cycle when the set temperature is reached.

Clean:

With the oven door closed, contacts COM to NO of the oven door switch close. Then when the clean pad is touched and a clean time is set the door lock relay on the electronic oven control closes providing line to neutral voltage (120 VAC) to the lock motor. The lock motor starts to rotate, closing the contacts of the door lock switch. When the motor rotates one half turn the contacts of the door lock switch reopen sending a signal to the EOC that the door is locked, and to open the contacts of the lock relay. The lock indicator light then glows steady and the EOC closes the bake relay providing power to the bake element. The clean temperature is preset into the EOC at around 850° F. It takes about 45 minutes for the oven to reach 850° F. When the temperature is reached the control cycles the bake element off and on to maintain the temperature until the clean time is completed. When the clean time is completed the EOC removes power from the bake element and the oven cools down. When the temperature in the oven goes below 500° F the control closes the contacts of the lock relay. The lock motor then turns 180 degrees closing and reopening the contacts of the lock switch and unlocking the door. The open contacts of the lock switch tells the control that the door is unlocked and to open the contacts of the lock relay and turn the lock indicator light off.

Calibration:

To check oven calibration:

1. Place a thermometer or thermocouple in the center of the oven.
2. Program the oven for bake and the temperature to 350° F. Allow the oven to cycle three times.
3. Average the highest and lowest reading. The average should be within 10° F of 350° F.

To change the calibration:

To adjust the oven temperature higher:

1. Press the **Bake pad** for 6 seconds. "0" will appear in the display.

NOTE: If any numbers other than "0" appear in the display, the control has been previously calibrated in the field. (Temperature can be changed ±35° F)

2. To increase the temperature, use the number pads to enter the desired change. The temperature may be increased up to 35° F.

3. Press **Start** to accept the temperature change and the display will return to the time of day. Press **Clear Off** to reject the change if necessary.

To adjust the oven temperature lower:

1. Press the **Bake pad** for 6 seconds. "0" will appear in the display.
2. To decrease the temperature, use the number pads to enter the desired change and then press **Clean**. The temperature may be decreased up to 35° F. (NOTE: Pressing **CLEAN** allows the entry of negative degree change.)
3. Press **Start** to accept the temperature change and the display will return to the time of day. Press **Clear Off** to reject the change if necessary.

Troubleshooting:

The ES 450 has some self diagnostics built into the microprocessor to help in troubleshooting the system. When a failure occurs one of three codes will appear in the display window: F1, F3 or F9.

F1 code:

An F1 indicates a malfunction in the EOC itself, and the control should be replaced.

F3 code:

An F3 indicates a defective sensor, electronic oven control, thermal circuit breaker or the wiring in between. To determine which part is defective:

1. Disconnect the fifteen pin plug from the back of the oven control that connects the sensor to the oven control.
2. With an Ohmmeter, measure the resistance between pins 14 and 15 in the plug (not on the control board). If the meter reads around value of the oven temperature sensor resistance chart shown below, the oven control is defective. If the meter reads less than 800 Ohms or more than 3000 Ohms, go to step 3.
3. Disconnect the harness from the oven sensor and measure the resistance of the oven sensor. If the meter reads less than 800 Ohms or more than 3000 Ohms, the oven sensor is defective. If the reading is correct with the chart go to step 4.
4. Remove the rear cover of the range and connect an Ohm meter between the terminals of the thermal

circuit breaker. If the meter reads infinity the circuit breaker is defective. If the meter reads zero the wiring is defective.

RTD	SCALE
Temperature Degrees F.	Resistance (Ohms)
32 +/- 1.9	1000 +/- 4.0
75 +/- 2.5	1091 +/- 5.3
250 +/- 4.4	1453 +/- 8.9
350 +/- 5.4	1654 +/- 10.8
450 +/- 6.9	1852 +/- 13.5
550 +/- 8.2	2047 +/- 15.8
650 +/- 9.6	2237 +/- 18.5
900 +/- 13.6	2697 +/- 24.4

F9 code:

An F9 code indicates the EOC has detected a problem with the motor door latch assembly. Check the contacts of the lock switch, wiring to the lock motor assembly, and the lock motor.

Control will not program:

If the control will not program, check for an open sensor circuit. If the sensor circuit is good, replace the EOC.

Time bake does not operate:

If the time bake feature does not operate, check to be sure it is being programmed correctly. If it is being programmed correctly, then replace the control.

Convection bake:

Neither the fan motor or the assist element operates:

1. Remove power from range. Go to the back of the electronic oven control and disconnect the 15 pin plug. With the oven door closed, measure the resistance between pins 10 and 12 of the 15 pin plug (in the plug). If the meter reads open, check the door switch and the wiring from the electronic oven control to the door switch. If the meter reads zero go to step 2.
2. Measure the resistance between pins 5 and 7. If the meter reads around 40 Ohms the control is defective. If the meter reads infinity either the wiring to the fan motor and element is open or both the fan motor and the element are defective.

Fan motor does not operate:

1. If the convection element is heating then the fan motor itself or the wiring to the fan motor is defective. Also check for a blocked fan blade.

Convection element does not operate:

1. If the convection fan is operating then the element itself, the diode, or the wiring to the element is defective.

Control does not operate in preheat:

1. If the oven operates in bake but not preheat, the EOC is defective.

Blank display:

1. With the range connected to electrical power, go to the back of the control and measure the voltage drop between terminal L1 and neutral. If the meter reads line to neutral voltage (120 VAC), the control is defective. If the meter reads zero the wiring in the range is defective.

Bake element does not heat:

1. With the range connected to electrical power, go to the back of the oven control and measure the voltage drop between terminals BA and neutral with the control not programmed (clock operating only). If the meter reads line to neutral (120 VAC) the control is defective. If the meter reads zero, the bake element or the wiring to the bake element is defective. Go to step 2.
2. Remove the back from the range to gain access to the terminals of the bake element. Program the oven control for bake and measure the voltage drop across the terminals of the bake element. If the meter reads line to line voltage (240 VAC) the element is defective. If the meter reads zero the wiring to the element is open.

Broil element does not heat:

1. With the range connected to electrical power, go to the back of the oven control and measure the voltage drop between terminals BR and neutral with the control not programmed (clock operating only). If the meter reads line to neutral (120 VAC) the control is defective. If the meter reads zero the broil element or the wiring to the broil element is defective. Go to step 2.
2. Remove the back from the range to gain access to the terminals of the broil element. Program the oven control for broil and measure the voltage drop across the terminals of the broil element. If the meter reads line to line voltage (240 VAC) the element is defective. If the meter reads zero the wiring to the element is open.

Oven door does not lock when the oven is programmed for clean:

1. Remove power from the range, go the back of the control and disconnect the 15 pin plug. Measure the resistance between pins 5 and 6 of the 15 pin plug (in the plug). If the meter reads infinity, the lock motor or the wiring to the lock motor is defective. If the meter reads around 2400 ohms go to step 2.
2. Measure the resistance between pins 10 and 12 of the 15 pin plug with the oven door closed. If the meter reads infinity, the door switch or the wiring to the door light switch is defective. If the meter reads zero go to step 3.
3. Measure the resistance between pins 10 and 13 of the 15 pin plug. If the meter reads infinity the lock switch or the wiring to the lock switch is defective. If the meter reads zero the control is defective.

Oven door locks but the oven does not heat:

1. If the oven operates in normal bake, program the oven for clean and allow the door to lock. Disconnect the 15 pin plug from the oven control and measure the resistance between pins 10 and 11 in the plug. If the meter reads infinity the latch switch or the wiring to the latch is defective. If the meter reads zero the control is defective.

Door latch is partly closed with door open:

1. Program the oven for self-clean, remove the right-hand bodyside, and hold the door switch closed for 30 seconds. Touch cancel and hold door switch in for 30 seconds. The lock motor should lock and unlock the door.

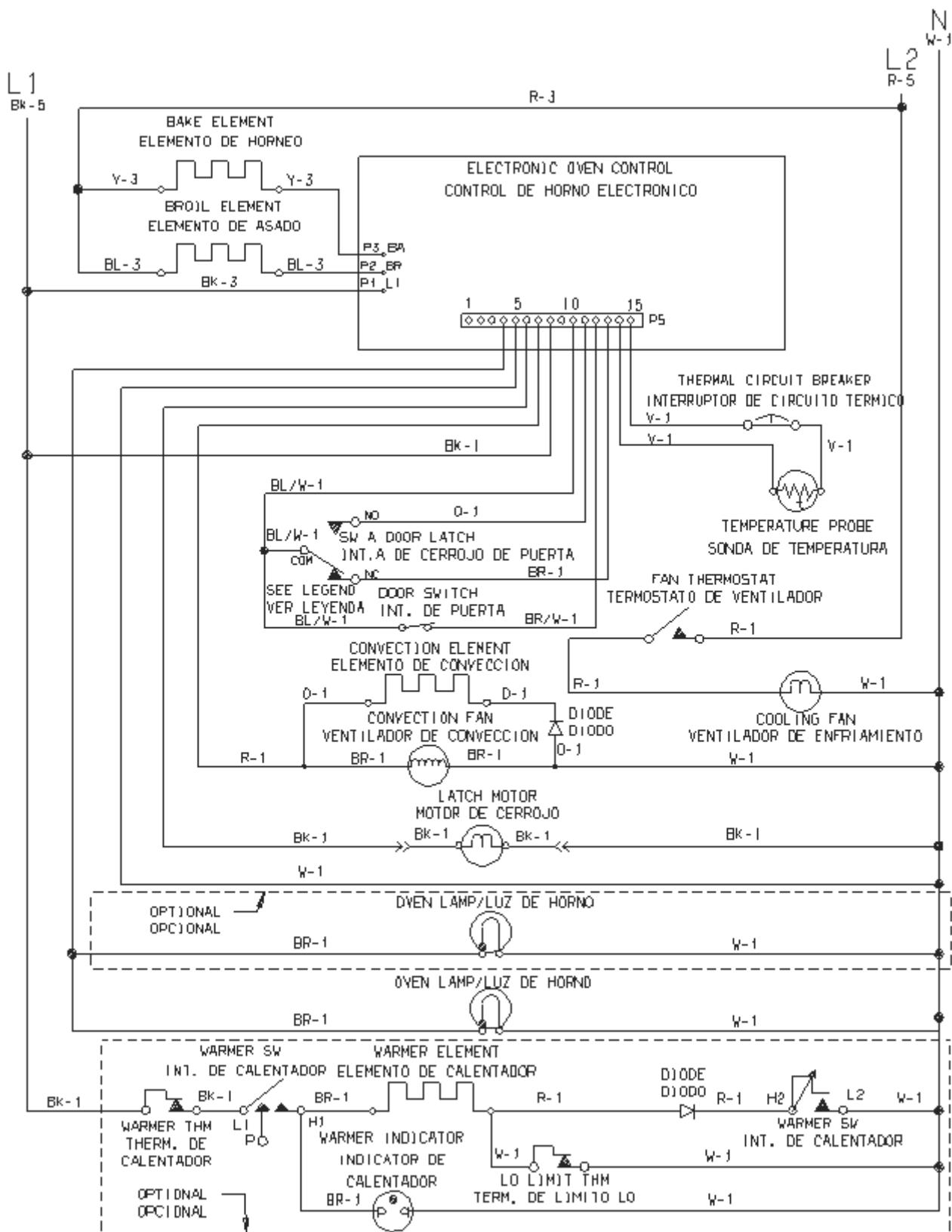

SAMPLE SCHEMATIC FOR THE ES 450 CONTROL SYSTEM

The PRC Glass touch electronic oven control models

Self-Cleaning Convection Models

NOTE: The basic timer is externally arranged in different configuration in various appliance models. This does not change the way it operates.

NOTE: Some of the models with a glass control panel have a touch pad control. To activate it, you just have to touch pad with a finger. Take care to have a good contact between the finger and the touch pad. Long nails can make the activation difficult. It is a good idea to clean the control panel after each use or as soon as possible after a spill, boil over or spatter because some ionic or salty ingredients as ketchup, tomatoes sauce, etc... can operate the control. Before cleaning the control panel it is recommended to activate the child safety lockout feature.

Control Pad Functions

Read the instructions carefully before using the oven.

For satisfactory use of your oven, become familiar with the various functions of the oven as described below. Detailed instructions for each function follow later in this book

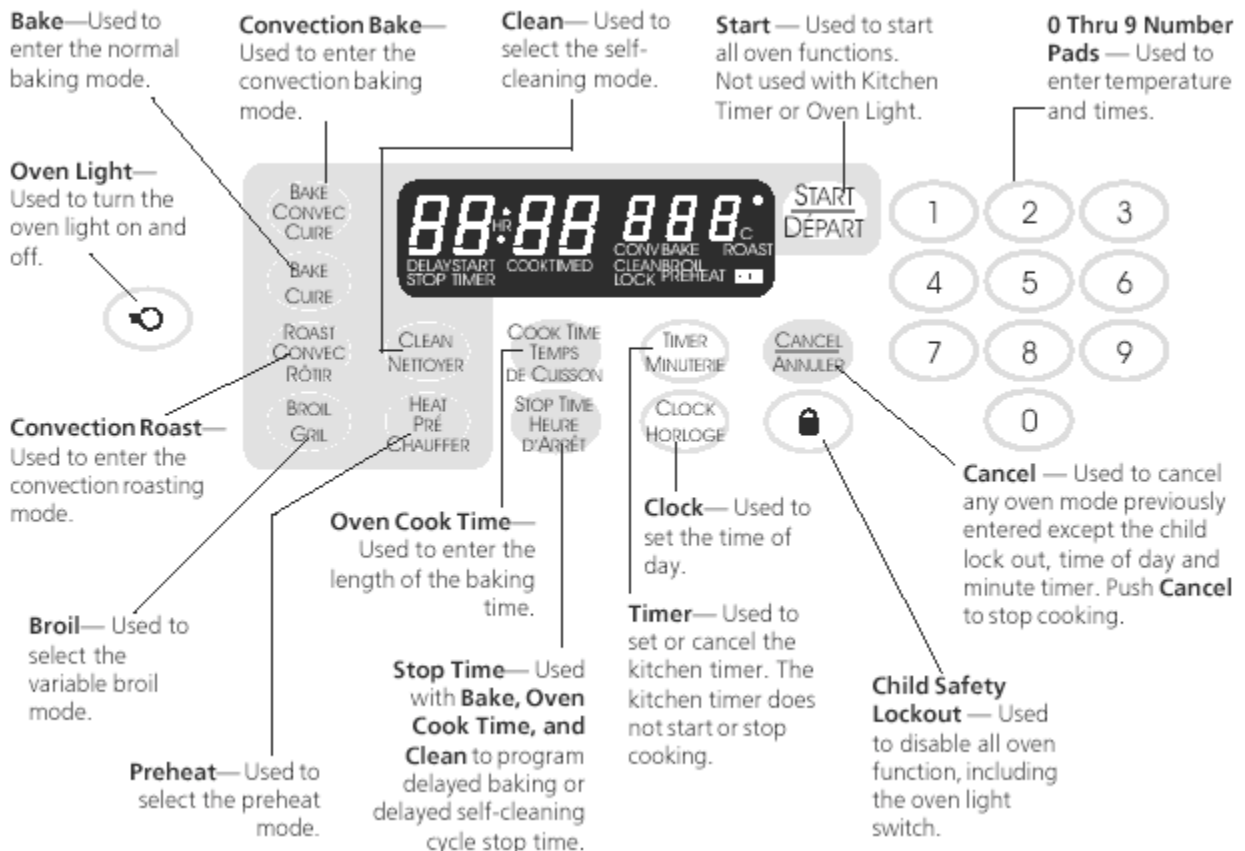
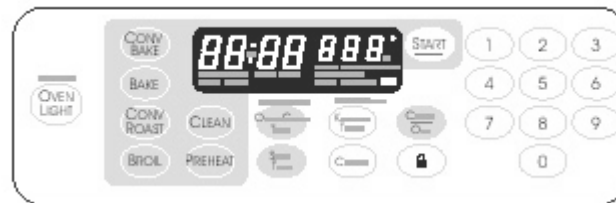

Electronic Oven Control

All oven functions have minimum and maximum values that may be entered into the control. These values are shown below. If you have trouble setting a mode, be sure you are not entering a value greater than or lower than the values shown in this chart. An ENTRY ERROR tone (3 short beeps) will sound if the value does not meet these limits.

Mode		Minimum Value	Maximum Value
Bake Temp		170°F/75°C	550°F/290°C
Broil Temp		450°F/230°C	HI-550°F/290°C
Conv. Bake Temp (some models)		170°F/75°C	550°F/290°C
Conv. Roast Temp (some models)		170°F/75°C	550°F/290°C
Preheat Temp		170°F/75°C	550°F/290°C
Kitchen Timer	12 hr	0:01 (hr/min)	11:59 (hr/min)
	24 hr	0:01 (hr/min)	23:59 (hr/min)
Clock Time	12 hr	1:00 (hr/min)	12:59 (hr/min)
	24 hr	0:00 (hr/min)	23:59 (hr/min)
Oven Cook Time	12 hr	0:05 (hr/min)	11:59 (hr/min)
	24 hr	0:05 (hr/min)	23:59 (hr/min)
Stop Time	12 hr	1:00 (hr/min)	12:59 (hr/min)
	24 hr	0:00 (hr/min)	23:59 (hr/min)
Clean Time		2 hours	4 hours

IMPORTANT: If more than one operation is needed to program your oven, your timer allows a delay of 5 seconds between each operation.

Setting the Clock

Clock

The clock may be set for 12 or 24 hour Time of Day operation. Your clock has been preset at the factory for 12 hour operation. When the range is first plugged in or when the power supply to the range has been interrupted, the display will flash. Pressing any key will stop the display from flashing.

INSTRUCTIONS	PUSH	DISPLAY
To set the Clock: (example 1:30)		
1. Push Clock Time will flash.	Clock	12:34
2. Push 1 3 0 To set the time of day to 1:30 Time will disappear after 4 seconds and the clock will start. You can also push Start Time will disappear and the clock will start	1 3 0 Start	1:30
To change from 12 to 24 hour Time of Day operation		
1. Push and hold Clock for 6 seconds; Time will flash, a beep will sound and the display will show 12 or 24 to indicate the option selected.	Clock for six seconds	24
2. When Clock is released the time of day will be displayed. Reset the current time following the steps above.		

Energy Saving Mode:

All our models have the possibility to operate over 24 hours but the electronic oven control has been preset at the factory to limit all cooking operations to 12 hours. This prevents the oven from being accidentally set to operate for excessive time periods.

INSTRUCTIONS

PUSH

DISPLAY

To deactivate the energy Mode:

1. Push and hold **Clean** until a beep sounds and the display shows **OFF**.
2. When **Clean** is released the time of day will be displayed.

Clean
for six seconds

OFF

To reactive the Energy Saving Mode:

1. Push and hold **Clean** until a beep sounds and the display show **ON**.
2. When **Clean** is released the time of day will be displayed.

Clean
for six seconds

On

Timer Reminder

The control is programmed to beep 1 minute before any timed operation ends. To turn this feature on or off:

INSTRUCTIONS

PUSH

DISPLAY

To deactivate the Timer Reminder

1. Push and hold **Cook Time Temps** until a beep sounds and the display show **OFF**.

**Cook Time
Temps**
for six seconds

OFF

To reactivate the Timer Reminder:

1. Push and hold **Cook Time Temps** until a beep sounds and the display show **ON**.

**Cook Time
Temps**
for six seconds

On

Kitchen Timer

The kitchen timer serves as an extra timer in the kitchen that will beep when the set time has run out. It does not start or stop cooking. The kitchen timer can be used during any of the other functions. The timer can be set for any amount of time from 1 minute to 11 and 59 minutes in the 12 hour mode or 1 minute to 23 hour 59 minutes in the 24 hour mode.

INSTRUCTIONS

PUSH

DISPLAY

To set the Kitchen timer Timer: (example 5 minutes)

1. Push **Timer**; **0:00** will be displayed and **TIMER** will flash
2. Push the number pads to set the desired time in the display (example **5**). Push **Start**, the time will began to count down and **TIMER** will be displayed. If **Start** is not pushed the timer will start automatically after 4 seconds.
3. If the timer is not deactivated, one minute before the time runs out you will hear a beep and the display will show minutes and seconds. When the set time has run out, **END** will be displayed and 3 beeps will sound every 60 seconds until **Timer** is pushed.

Timer

0:00

5 Start

**:05
TIMER**

Timer

**END
TIMER**

To Change the Minute Timer while in use:

1. Push **Timer**, enter the new time using the NUMBER PADS and push **Start**. If **Start** is not push the timer will start automatically after 4 seconds.

Timer

**:05
TIMER**

INSTRUCTIONS

PUSH

DISPLAY

To Cancel the Minute Timer before the set time has run out:

Push **Timer** and 0.

Timer

1:30

Child Safety Lockout Feature:

The Child Safety Lockout feature prevents the oven elements from being accidentally turned on. It does not disable the clock, minute timer, oven light, surface elements or surface burners. This added feature is to help in the effort to keep children safe. It is not meant to be a replacement for adult supervision.

INSTRUCTIONS

PUSH

DISPLAY

To activate the child safety Lockout:

1. Push and hold **LOC** until **LOC** is displayed to indicate that the Child Safety Lockout is activated.



for 3 seconds

1:30 LOC

To reactivate Oven operation:

1. Push and hold **LOC** until LOC disappears and the time of day is displayed.
2. The oven can be programmed.



for 3 seconds

1:30

Temperature Display - Fahrenheit or Celsius:

The oven control can be programmed to display temperatures in Fahrenheit or Celsius. Your range has been preset at the factory to display Fahrenheit.

INSTRUCTIONS

PUSH

DISPLAY

**To change from Fahrenheit to Celsius or Celsius to Fahrenheit:
(example: change from Fahrenheit to Celsius)**

1. Identify which display your control is set for. To tell if your range is set For Fahrenheit or Celsius push **Bake**. If the temperature display is **350°** your range is set for Fahrenheit. If the temperature display is **176°** your range is set for Celsius.
2. Push and hold **Broil** until a beep sounds. If your range was originally set for Fahrenheit the letter **C** will appear; if the range has been changed to Celsius the letter **F** will appear.
3. Release the pad; the time of day will be displayed.



1:30 350°
START BAKE



for 6 seconds

C

Preheat

Preheating the oven provides maximum cooking performance. The Preheat Mode will bring the oven up to temperature and then beep to let you know when to add your food. Preheating the oven is recommended when baking breads and cakes but not necessary when cooking casseroles. The oven can be programmed to preheat at any temperature from 170°F to 550° (75°C to 290°C).

INSTRUCTIONS

PUSH

DISPLAY

To set the preheat temperature to 350°F (176°C)

1. Arrange oven racks.
2. Push **Preheat**; **350°F (176°C)** will be displayed; **BAKE** and **START** will flash.
3. Push **Start**; **PrE**, **BAKE** and **ON** will be displayed as the oven heats up.



1:30 350°
START BAKE



1:30 PrE
ON BAKE

To change the preset Preheat Temperature: (example 425°F (218°C))

1. Arrange oven racks.

2. Push **Preheat** ; **350°F (176°C)** will be displayed; **BAKE** and **START** will flash. **Preheat**

1:30 350°
START BAKE

3. Enter the desired baking temperature using the numbers pads

4 2 5

4 2 5

1:30 425°
START BAKE

4. Push **Start** **PrE, Bake and ON** will be displayed as the oven heats up.

Start

1:30 PrE
BAKE

After the oven has reached the desired temperature the control will beep and the "PrE" light will turn off and the desired oven temperature will be shown. The oven is preheated; **place food in the oven**. The **BAKE** light will stay on. The **ON** light will turn on and off as the oven maintains its temperature.

1:30 425°
ON BAKE

When baking is complete press **Clear**

Clear

1:30

Bake

Use this mode when preheating is not necessary, such as, when cooking casseroles. Allow your oven to preheat when baking cake and pastry or roasting. A beep lets you know when the bake temperature is reached. The oven can be programmed to bake at any temperature from 170°F to 550°F (75°C to 290°C).

INSTRUCTIONS

PUSH

DISPLAY

To Set the Bake Temperature to 350°F (176°C):

1. Arrange oven racks and place food in oven.

2. Push **Bake**. **350°F (176°C)** will be displayed; **BAKE** and **START** will flash. **Bake**

1:30 350°
START BAKE

3. Push **Start**. The current oven temperature, **BAKE** and **ON** will be displayed. As the oven temperature increases the display counts up to the set temperature. **Start**

1:30 350°
BAKE ON

To change the preset Bake Temperature: (example 425°F (218°C))

2. Push **Bake**. **350°F (176°C)** will be displayed; **BAKE** and **START** will flash. **Bake**

1:30 350°
START BAKE

3. Enter the desired baking temperature using the numbers pads

4 2 5

4 2 5

1:30 425°
START BAKE

4. Push **Start**. The current oven temperature, **BAKE** and **ON** will be displayed. As the oven temperature increases the display counts up to the set temperature. **Start**

1:30 425°
BAKE ON

After the oven has reached the desired temperature the control will beep and the **BAKE** light will stay on. The ON light will turn on and off as the oven maintains your chosen temperature.

When baking is complete press **Cancel**.

Cancel

1:30

Broil

Broiling is a method of cooking tender cuts of meat by direct heat under the broil element of the oven. A beep lets you know when the broil temperature is reached. Be sure you center the broiler pan directly under the broil element for best results.

Arrange oven rack while oven is still cool. Position the rack as needed.

The broiler pan and its insert allow dripping grease to drain and be kept away from the high heat of the broiler. **DO NOT** use the pan without its insert. **DO NOT cover the insert with foil.** The exposed grease could ignite.



Should an oven fire occur, close the oven door and turn off the oven. If the fire continues, throw baking soda on the fire or use a fire extinguisher. **DO NOT** put water or flour on the fire. Water can cause a grease fire to spread and flour may be explosive and cause personal injury.

INSTRUCTIONS

To Set the oven to Broil at HI 550°F (290°C):

1. Place the insert on the broiler pan, then place the food on the insert. **DO NOT** use the broiler pan without the insert, or cover the insert with Aluminum foil; the exposed fat could ignite.
2. Arrange oven rack and place the pan on the oven rack. Be sure to center the broiler pan directly under the broil element. **Open the oven door to the “Broil Stop” position when broiling.**
3. Push **Broil**; **HI** will be displayed; **START** and **BROIL** will flash.
4. Push **Start**; **HI**, **BROIL** and **ON** will be displayed.
5. Broil on one side until food is browned; turn and cook on the second side. Season and serve. **Note:** Always pull the rack out to the stop position before turning or removing food.
6. The **BROIL** light will stay on. The **ON** light may turn on and off as the oven maintains your chosen temperature.

PUSH

DISPLAY

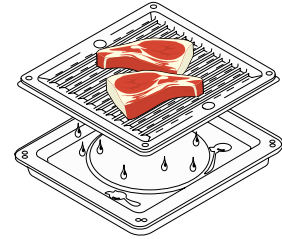

Broil

1:30 HI
BROIL ON

Start

To change the preset Broil Temperature: example 450°F (232°C)

1. Push **Broil**; **HI** will be displayed; **START** and **BROIL** will flash. Enter the desired broil temperature using the number pads **4 5 0** and push **Start**. **450°**, **BROIL** and **ON** will be displayed.

Broil

1:30 450°
BROIL ON

4 5 0

Start

When broiling is complete press **Cancel**

Cancel

1:30

Convection Bake (Some models)

This method of cooking enable you to obtain the best results when baking, thawing, dehydrating and batch cooking. Always preheat your oven before baking. A beep will let you know when the convection bake temperature is reached. The oven can be programmed to convection bake at any temperature from 170°F to 550°F (75°C to 290°C). Because convection baking is so efficient, your oven control will automatically control the temperature 25°F/12°C lower than the set temperature when the convection bake mode is selected. You can use the normal temperature recommended in your recipes. Remember to use tested recipes with times adjusted for convection baking when using the convection mode. Times may be reduced by as much as 30% when using the convection feature.

INSTRUCTIONS

PUSH

DISPLAY

To Set the oven to Convection Bake at 350°F (176°C):

1. Arrange oven racks and place food in oven.
2. Push **Convec bake**. **350°F (176°C)** will be displayed; **CONV BAKE** and **START** will flash.
3. Push **Start**. The current oven temperature, **CONV BAKE** and **ON** will be displayed. As the oven temperature increases the display counts up to the set temperature.



To change the preset Convection Bake Temperature: (example 425°F (218°C))

2. Push **Convec Bake**. **350°F (176°C)** will be displayed; **CONV BAKE** and **START** will flash.
3. Enter the desired baking temperature using the numbers pads
④ ② ⑤
4. Push **Start**. The current oven temperature, **CONV BAKE** and **ON** will be displayed. As the oven temperature increases the display counts up to the set temperature.

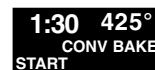
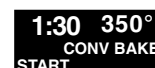

After the oven has reached the desired temperature the control will beep and the **CONV BAKE** light will stay on. The **ON** light will turn on and off as the oven maintains your chosen temperature.

When convection baking is complete press **Cancel**.



Convection Roast (Some models)

This method of cooking enable you to obtain the best results when roasting. Always preheat your oven before roasting. A beep will let you know when the convection roast temperature is reached. The oven can be programmed to convection roast at any temperature from 170°F to 550°F (75°C to 290°C). Remember to use tested recipes with times adjusted for convection roasting when using the convection mode. Times may be reduced by as much as 30% when using the convection feature.

INSTRUCTIONS

PUSH

DISPLAY

To Set the oven to Convection Roast at 350°F (176°C):

1. Arrange oven racks and place food in oven.
2. Push **Convec Roast**. **350°F (176°C)** will be displayed; **CONV ROAST** and **START** will flash.
3. Push **Start**. **CONV Roast** and **ON** will be displayed. As the oven temperature increases the display counts up to the set temperature.



To change the preset Convection Bake Temperature: (example 425°F (218°C))

2. Push **Convec Roast**. **350°F (176°C)** will be displayed; **CONV ROAST**, **START** and **ON** will flash.
3. Enter the desired baking temperature using the numbers pads
④ ② ⑤
4. Push **Start**. The current oven temperature, **CONV Roast** and **ON** will be displayed. As the oven temperature increases the display counts up to the set temperature.

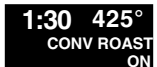
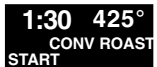
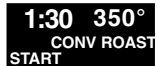

After the oven has reached the desired temperature the control will beep and the **CONV Roast** light will stay on. The **ON** light will turn on and off as the oven maintains your chosen temperature.

When convection roasting is complete press **Cancel**.

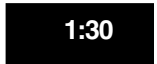

Timed Bake

COOK TIME or **STOP TIME** controls the Time Bake operation. The automatic timer will turn the oven **off** at the time you select. Timed bake includes convection baking and roasting (feature available with some models only).

CAUTION Use caution when using the automatic timer. Use the automatic timer when cooking cured or frozen meats and most fruits and vegetables. Foods that can easily spoil such as milk, egg, fish, meat or poultry, should be chilled in the refrigerator first. Even when chilled, they should not stand in the oven for more than 1 hour before cooking begins, and should be removed promptly when cooking is completed. Eating spoiled food can result in sickness from food poisoning.

INSTRUCTIONS

PUSH

DISPLAY

To Program the Oven to Begin Immediately and To Shut Off Automatically: (example Bake at 350°F (176°C) for 50 minutes)

1. Be sure that the clock shows the correct time of day.
2. Arrange oven rack and, if roasting or cooking a casserole, place the food in the oven.
3. Push **(Bake)**; **350°F (176°C)** will be displayed; **BAKE** and **START** will flash. If a different desired baking temperature is needed use the number pads.
4. Push **(Cook time)** **0:00** will be displayed; **START** and **COOK TIME** will flash. Enter the desired baking time using the number pads **(5)** **(0)**. The baking time can be set for any amount of time from 5 minutes to 11 hours and 59 minutes (or 23 hours and 59 minutes in the 24 hour mode).
5. Push **(Start)**; **TIMED** and **ON** will be display; the **BAKE** light will stay on. The **ON** light will turn on and off as the oven maintains its temperature.

(Bake)

1:30 350°
START BAKE

(Cook Time)

HR 50
START COOK TIME

(5) (0)

(Start)

1:30 350°
TIMED BAKE ON

When the set BAKE TIME runs out:

1. **END** and **COOK TIME** will be displayed and the oven will shut off Automatically
2. The control will beep 3 times.
3. The control will then continue to beep 3 times each minute until **(Cancel)** is pushed.
4. To display the remaining time push on Cook Time .

(Cancel)

End
COOK TIME

(Cook Time)

2:20

Delayed Timed Bake

COOK TIME or **STOP TIME** controls the Time Bake operation. The automatic timer will turn the oven **on and off** at the time you select. Timed bake includes convection baking and roasting (feature available with some models only).



Use caution when using the automatic timer. Use the automatic timer when cooking cured or frozen meats and most fruits and vegetables. Foods that can easily spoil such as milk, egg, fish, meat or poultry, should be chilled in the refrigerator first. Even when chilled, they should not stand in the oven for more than 1 hour before cooking begins, and should be removed promptly when cooking is completed. Eating spoiled food can result in sickness from food poisoning.

INSTRUCTIONS

PUSH

DISPLAY

To Program Oven for a Delayed Start Time and To Shut Off Automatically: (example Bake at 350°F (176°C) for 50 minutes finishing at 5:30)

1. Be sure that the clock shows the correct time of day.
2. Arrange oven rack and, if roasting or cooking a casserole, place the food in the oven.
3. Push **Bake**; **350°F (176°C)** will be displayed; **BAKE** and **START** will flash. If a different desired baking temperature is needed use the number pads.
4. Push **Cook Time**; **0:00** will be displayed; **START** and **COOK TIME** will flash. Enter the desired baking time using the number pads **5 0**. The baking time can be set for any amount of time from 5 minutes to 11 hours and 59 minutes (or 23 hours and 59 minutes in the 24 hour mode).
5. Push **Stop Time**; enter the desired stop time using the number pads **5 3 0**.
6. Push **Start**; **350°**, **BAKE**, **DELAY** and **TIMED** will be display; the **BAKE**.
7. When the start time arrives the display will show the current time of day and **TIMED BAKE**. The **ON** light will turn on and off as the oven maintains your chosen temperature.

Bake

Cook Time

5 0

Stop Time

5 3 0

Start

4:00 350°
BAKE
START

HR 50
START COOK TIME

5:30
START TIMED
STOP TIME

4:00 350°
TIMED BAKE
DELAY

4:40 350°
TIMED BAKE
ON

When the set BAKE TIME runs out:

1. **END** and **COOK TIME** will be displayed and the oven will shut off Automatically
2. The control will beep 3 times.
3. The control will then continue to beep 3 times each minute until **Cancel** is pushed.

Cancel

End
COOK TIME

5:30

To Start the Self-Clean Cycle

*We recommend a 2 hour self-clean cycle for **light soils**, a 3 hour cycle for **average soils**, and a 4 hour cycle for **heavy soils** (to assure satisfactory results).

⚠ WARNING During the self-cleaning cycle, the outside of the range can become very hot to the touch. **DO NOT** leave small children unattended near the appliance; they may be burned if they touch the hot surfaces.

⚠ CAUTION **DO NOT** force the oven door open. This can damage the automatic door locking system. Use care when opening the oven door after the self-cleaning cycle. Stand to the side of the oven when opening the door to allow hot air or steam to escape. The oven may still be **VERY HOT**.

Note: The oven lights will not operate during the self cleaning cycle.

INSTRUCTIONS

PUSH

DISPLAY

To Set the Controls for the Self-Cleaning Cycle To Start Immediately and Shut Off Automatically:

1. Be sure the clock shows the correct time of day, the oven is empty and door is closed.
2. Push **Clean**; 3:00 will be displayed; **START, TIMED** and **CLEAN** will flash. If a 2 or 4 hour clean is desired use the number pads to enter the time. Set the cleaning time based on the amount of soil you have - light, medium or heavy. *See above.
3. Push **Start**.
4. As soon as the controls are set, the motor driven lock will begin to close automatically and the **LOCK** indicator light will be displayed. (It takes about 15 seconds for the lock to close.) The **ON** light will turn on and off as the oven maintains self-cleaning temperatures.

Clean

3:00
CLEAN
START TIMED

Start

1:30 CLEAN
TIMED LOCK
ON

When the Self-Clean Cycle is Completed

1. The time of day and the word **LOCK** will remain in the display.
2. Once the oven has cooled down for 1 hour, and the word **LOCK** shown in the display has gone out, the oven door can be opened.

4:30
LOCK

Stopping or Interrupting a Self-Cleaning cycle

If it becomes necessary to stop or interrupt a self-cleaning cycle due to excessive smoke or fire in the oven:

1. Push **Cancel**.
2. Once the oven has cooled down for 1 HOUR and the word **LOCK** shown in the display has gone out, then the oven door can be opened.

Cancel

4:30

To Start the delayed Self-Clean Cycle

COOK TIME and **STOP TIME** control the Delayed Self-Clean operation. The automatic timer will turn the oven on and off at the time you select. If you are planning to use the oven directly after a self-clean cycle remember to allow time for the oven to cool down and the lock to unlock. This normally takes about one hour. So if you set a 3 hour self-clean cycle, it will be 4 hours before you can cook again.

*We recommend a 2 hour self-clean cycle for **light soils**, a 3 hour cycle for **average soils**, and a 4 hour cycle for **heavy soils** (to assure satisfactory results).

CAUTION During the self-cleaning cycle, the outside of the range can become very hot to the touch. **DO NOT** leave small children unattended near the appliance; they may be burned if they touch the hot surfaces.

CAUTION **DO NOT** force the oven door open. This can damage the automatic door locking system. Use care when opening the oven door after the self-cleaning cycle. Stand to the side of the oven when opening the door to allow hot air or steam to escape. The oven may still be **VERY HOT**.

Note: The oven lights will not operate during the self cleaning cycle.

INSTRUCTIONS

PUSH

DISPLAY

To Set the Controls for the Self-Cleaning Cycle To Start at a Delayed Time and Shut off Automatically: (example self-clean cycle to finish at 9:00)

1. Be sure the clock shows the correct time of day, the oven is empty and door is closed.



2. Push **Clean**; 3:00 will be displayed; **START, TIMED** and **CLEAN** will flash. If a 2 or 4 hour clean is desired use the number pads to enter the time. Set the cleaning time based on the amount of soil you have - light, medium or heavy. *See above.



3. Push **Stop Time**. Enter the desired Stop Time using the number pads **9 0 0**.

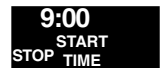

9 0 0

9 0 0



4. Push **Start**.



5. As soon as the controls are set, the motor driven lock will begin to close automatically and the **LOCK** indicator light will be displayed. (It takes about 15 seconds for the lock to close.) **DELAY, TIMED** and **CLEAN** will be displayed.

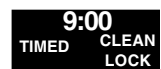

6. The control will calculate backward from the set stop time to determine when the self-cleaning cycle should begin. The self-cleaning cycle will come on automatically at the calculated time. At that time, the word **DELAY** will go out and **ON** will appear.

When the Self-Clean Cycle is Completed

1. The time of day and the word **LOCK** will remain in the display.



2. Once the oven has cooled down for 1 hour, and the word **LOCK** shown in the display has gone out, the oven door can be opened.

Adjusting Oven Temperature

Note: The adjustments made will not change the self-cleaning temperature.

The temperature in the oven is set at the factory. When first using the oven, be sure to follow recipe times and temperatures. If you think the oven is too hot or too cool, the temperature in the oven can be adjusted. Before adjusting, test a recipe by using a temperature setting that is higher or lower than the recommended temperature. The baking results should help you decide how much of an adjustment is need.

INSTRUCTIONS	PUSH	DISPLAY
To Adjust Oven Temperature: (example 30°F, hotter or cooler)		
1. Push Bake for 6 seconds.	Bake	1:30 00°
2. To increase the temperature, use the number pads to enter the desired adjustment 3 0 . The temperature may be increased up to 35°F (17°C). When you have made the desired adjustment, push Cancel to go back to the time of day display.	3 0 Cancel	1:30 30°
3. To decrease the temperature use the number pads to enter the desired adjustment 3 0 and push Start . The temperature may be decreased by -35°F (17°C). When you have made the desired adjustment, push Cancel to go back to the time of day display. When adjusting oven temperature, a minus sign (-) will appear before the number to indicate that the oven will be cooler by the displayed amount of degrees.	3 0 Start Cancel	1:30 -30°

Failure Modes

All failure modes give a visual and audible alarm. When the display shows **F1**, **F3** or **F9**, electronic control has detected a fault condition. Note that code and push the **CANCEL** pad to clean the display and stop the beeping. Reprogram the oven. If fault recurs, push **CANCEL** pad, disconnect the appliance to prevent damage and contact authorized servicer.

How the PRC Glass touch electronic oven control works:

The PRC glass touch electronic oven control system is made up of four parts that control the bake and broil elements, the convection fan in the oven, oven light, and the locking of the door in clean.

1. Electronic oven control.
2. Glass touch panel
3. Oven temperature sensor.
4. Oven door lock mechanism.

Capacitance touch glass:

The capacitance touch glass is used to allow user to input command to the electronic control board. Metal plates that form capacitors are fasten to the back of the glass behind each input touch areas designed on the glass and connected to the electronic control board by a ribbon. The microprocessor reads the capacitance of the capacitors. When the glass is touched in the indicated area the capacitance changes giving an input to the control board.

Preheat:

When the preheat pad is touched and a temperature is entered with the number pads, the bake relay and the double line break relay on the board closes, and apply electrical power bake element. "PRE" and "BAKE" appear in the display. After the first cycle "PRE" disappears and the oven operates as in normal bake.

Bake:

When the bake pad is touched, and a temperature is entered with the number pads, the bake relay on the board closes, and connects one side of the line to the bake element. "BAKE" appears in the display. In the tip of the oven sensor is a positive thermistor that increases in resistance as the oven temperature increases. The EOC microprocessor reads the resistance of the oven sensor, and compares it with the programmed temperature set into the control. When the resistance of the oven sensor indicates temperature in the oven is about 10 degrees above the programmed temperature, the microprocessor opens the relay, which removes power from one side of the element. When power is removed from the element the oven temperature begins to lower. As the oven temperature lowers the resistance of the oven sensor decreases. When the oven drops to about 10 degrees below the programmed temperature, the resistance of the sensor tells the microprocessor to

close the relay contacts, and once again provide power to the element. After the first cycle and whenever the oven calls for heat, the EOC cycles the broil element on for seven seconds and then the bake element on for fifty three seconds out of every minute. This provides top heat during the bake cycle. The two elements are never on at the same time.

NOTE: Oven controls may have a temperature swing of more or less than 20 degrees. The important thing is the average temperature in the oven. The average temperature in the center of the oven should be within 10 degrees of the programmed temperature.

Timed bake:

The timed bake function allows the oven to be programmed to stop bake at a set time, or to delay the start and stop baking at a set time. The stop time cannot be set for more than 11 hours and 59 minutes ahead of the time of day.

Convection bake:

When the convection bake pad is touched and a temperature is set, two things happen that do not happen in normal bake. The EOC automatically lowers the oven temperature 25° F below the temperature that was manually set in the control. If the oven door is closed, the convection relay on the EOC closes, providing line to neutral voltage to the convection fan motor and the convection assist element. This relay remains closed until the program is canceled or is interrupted by the opening of the oven door. If interrupted by the opening of the oven door, the relay will automatically close when the door is closed.

Convection roast:

Convection roast operates the same as convection bake except the control does not operate below the set temperature and the temperature differential is larger.

Broil:

When the broil pad is touched, and a temperature is entered with the numbers between 450° F and 550° F (usually 550° F), the broil relay on the board closes, and connects one side of the line to the broil element. In the tip of the oven sensor is a positive thermistor that increases in resistance as the oven temperature increases. The EOC microprocessor reads the resistance of the oven sensor, and compares it with the programmed temperature set into the control. Usually you do not want the broil element to cycle so the oven door is opened to the broil stop position. If the door is not opened the broil

element will cycle when the set temperature is reached.

Clean:

With the oven door closed, contacts COM to NO of the oven door switch close. Then when the clean pad is touched and a clean time is set the door lock relay on the electronic oven control closes providing line to neutral voltage (120 VAC) to the lock motor. The lock motor starts to rotate, closing the contacts of the door lock switch. When the motor rotates one half turn the contacts of the door lock switch reopen sending a signal to the EOC that the door is locked, and to open the contacts of the lock relay. The lock indicator light then glows steady and the EOC closes the bake relay providing power to the bake element. The clean temperature is preset into the EOC at around 850° F. It takes about 45 minutes for the oven to reach 850° F. When the temperature is reached the control cycles the bake element off and on to maintain the temperature until the clean time is completed. When the clean time is completed the EOC removes power from the bake element and the oven cools down. When the temperature in the oven goes below 500° F the control closes the contacts of the lock relay. The lock motor then turns 180 degrees closing and reopening the contacts of the lock switch and unlocking the door. The open contacts of the lock switch tells the control that the door is unlocked and to open the contacts of the lock relay and turn the lock indicator light off.

Calibration:

To check oven calibration:

1. Place a thermometer or thermocouple in the center of the oven.
2. Program the oven for bake and the temperature to 350° F. Allow the oven to cycle three times.
3. Average the highest and lowest reading. The average should be within 10° F of 350° F.

To change the calibration:

To adjust the oven temperature higher:

1. Press the **Bake pad** for 6 seconds. "00" will appear in the display.

NOTE: If any numbers other than "00" appear in the display, the control has been previously calibrated in the field.

2. To increase the temperature, use the number pads to enter the desired change. The temperature may

be increased up to 35° F.

3. Press **Cancel** to accept the temperature change and the display will return to the time of day.

To adjust the oven temperature lower:

1. Press the **Bake pad** for 6 seconds. "00" will appear in the display.
2. To decrease the temperature, use the number pads to enter the desired change and then press **Start**. The temperature may be decreased up to 35° F.
3. Press **Cancel** to accept the temperature change and the display will return to the time of day.

Troubleshooting:

The PRC Glass touch has some self diagnostics built into the microprocessor to help in troubleshooting the system. When a failure occurs one of three codes will appear in the display window: F1, F3 or F9.

F1 code:

An F1 indicates a malfunction in the EOC itself, and the control should be replaced.

F3 code:

An F3 indicates a defective sensor, electronic oven control or the wiring in between. To determine which part is defective:

1. Disconnect the seven pin plug from the back of the EOC that connects the sensor to the oven control.
2. With an Ohmmeter measure the resistance between pins 6 and 7 in the P3 plug (not on the EOC). If the meter reads around the value of the oven temperature sensor resistance chart shown below, the oven control is defective. If the meter reads less than 800 Ohms, or more than 3000 Ohms, go to step 3.

RTD	SCALE
Temperature Degrees F.	Resistance (Ohms)
32 +/- 1.9	1000 +/- 4.0
75 +/- 2.5	1091 +/- 5.3
250 +/- 4.4	1453 +/- 8.9
350 +/- 5.4	1654 +/- 10.8
450 +/- 6.9	1852 +/- 13.5
550 +/- 8.2	2047 +/- 15.8
650 +/- 9.6	2237 +/- 18.5
900 +/- 13.6	2697 +/- 24.4

3. Disconnect the harness from the oven sensor and measure the resistance of the oven sensor. If the meter reads less than 800 Ohms, or more than 3000 Ohms, the oven sensor is defective. If the reading is correct with the chart the harness is defective.

F9 code:

An F9 code indicates the EOC has detected a problem with the motor door latch assembly. Check the contacts of the lock switch, wiring to the lock motor assembly, and the lock motor.

Control will not program:

If the control will not program, remove the ribbon from the control and clean the end of the ribbon with a pencil eraser. If this does not correct the problem and if the control does not respond to any programming, replace the control board. If the control responds to some programming but not all replace the glass.

Time bake does not operate:

If the time bake feature does not operate, check to be sure it is being programmed correctly. If it is being programmed correctly, then replace the control.

Convection bake:

Fan motor does not operate:

1. Remove the convection fan cover in the oven and try to spin the fan blade. If the blade spins hard or is bound up, remove the blade and motor from the range to determine problem. If the blade spins freely go to step 2.
2. Remove power from range. Go to the back of the electronic oven control and disconnect plug P4. Measure the resistance between pin 6 of plug P4 and terminal L1 on the control board. If the meter reads open or shorted check the motor and the wiring to the motor. If the meter reads around 55 Ohms replace the control board.

Convection element does not heat:

1. Remove power from range. Go to the back of the electronic oven control. Measure the resistance between terminals E5 and L2. If the meter reads open or shorted check the element and the wiring to the element. If the meter reads around 24 Ohms replace the control board.

Control does not operate in preheat:

1. If the oven operates in bake but not preheat, the EOC is defective.

Blank display:

1. With the range connected to electrical power, go to the back of the control and measure the voltage drop between terminal L1 and neutral. If the meter reads line to neutral voltage (120 VAC), the control is defective. If the meter reads zero the wiring in the range is defective.

Bake element does not heat:

1. Program the control for bake. If the bake element does not heat go to step 2. If the element heats go to step 3.
2. With the range connected to electrical power, go to the back of the oven control and measure the voltage drop between terminals L1 and L2. If the meter reads zero, check the wires between the range terminal block and the control. If the meter reads line to line voltage (around 240 VAC) go to step 3.
3. Program the oven for bake and measure the voltage drop between terminals Bake and DLB. If the meter reads zero the control is defective. If the meter reads line to line voltage (around 240 VAC) the bake element or the wiring between the control and bake element is defective.

Broil element does not heat:

1. Program the control for broil. If the broil element does not heat go to step 2. If the element heats go to step 3.
2. With the range connected to electrical power, go to the back of the oven control and measure the voltage drop between terminals L1 and L2. If the meter reads zero, check the wires between the range terminal block and the control. If the meter reads line to line voltage (around 240 VAC) go to step 3.
3. Program the oven for broil and measure the voltage drop between terminals Broil and DLB. If the meter reads zero the control is defective. If the meter reads line to line voltage (around 240 VAC) the broil element or the wiring between the control and broil element is defective.

Oven door does not lock when the oven is programmed for clean:

1. Remove power from the range and go to the back of the control and disconnect the P3 plug. Measure the resistance between pins 3 and 4. If the meter reads infinity check the oven door switch and the wiring to the door switch. If the meter reads zero go to step 2.
2. Measure the resistance between pins 1 and 3 of plug P3. If the meter reads infinity switch A of the lock motor assembly or the wiring to switch A is defective. If the meter reads zero go to step 3.
3. Measure the resistance between pin 5 in plug P4 and terminal N. If the meter reads zero or infinity the lock motor or the wiring to the lock motor is defective. If the meter reads 2350 Ohms replace the electronic oven control.

Oven door locks but the oven does not heat:

1. If the oven operates in normal bake remove power and go to the back of the oven control. With the door locked measure the resistance between pins 1 and 2 in plug P4. If the meter reads infinity switch A of the lock motor assembly or the wiring to switch A is defective. If the meter reads zero the electronic oven control is defective.

Door latch is partly closed with door open:

1. Remove the right-hand bodyside, program the oven for self-clean, and hold in on the door switch for 30 seconds. Touch cancel and hold door switch in for 30 seconds. The lock motor should lock and unlock the door.

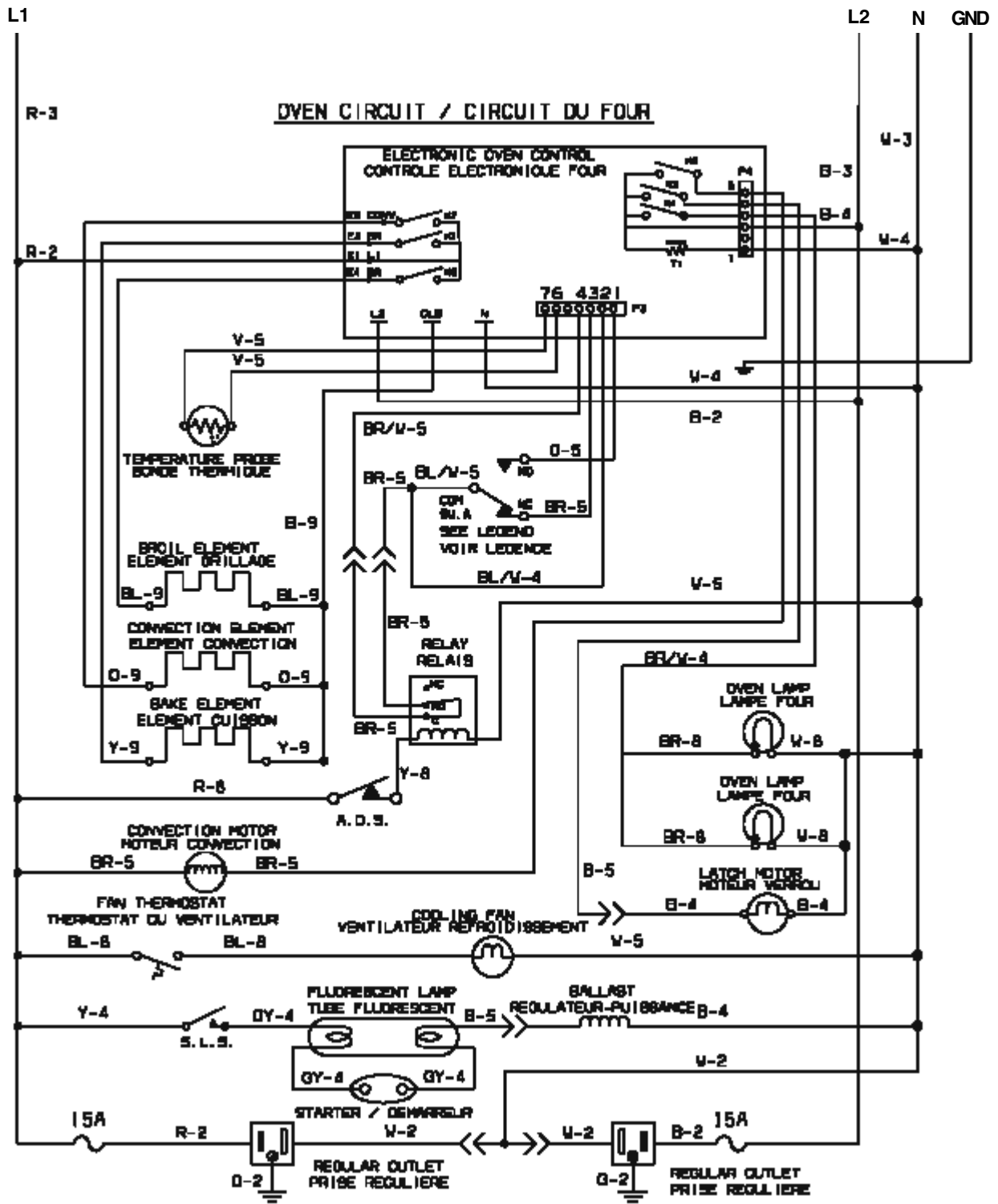

Sample schematic for PRC Glass touch control system

Warmer drawer:

Warmer drawers are used to hold food at serving temperature, usually between 160° F to 190° F.

To set the warmer drawer thermostat control:

The thermostat control is used to select the temperature of the warmer drawer. It is located on the control panel. To set the thermostat, push in and turn the knob to the desired setting. The temperatures are approximate, and are designated by HI, MED and LO.

1. Turn the knob to select the desired temperature setting.
2. For best results, preheat the drawer before adding food. An empty drawer will preheat in approximately 15 minutes.
3. Turn the thermostat control to **OFF** after use.

How the warmer drawer circuit works:

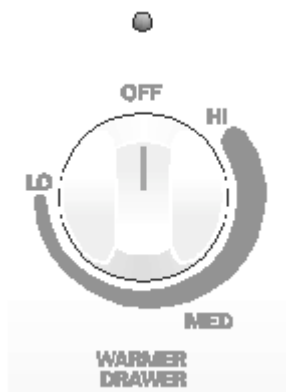

The warmer drawer circuit operates in two cycles: Preheat and Hold.

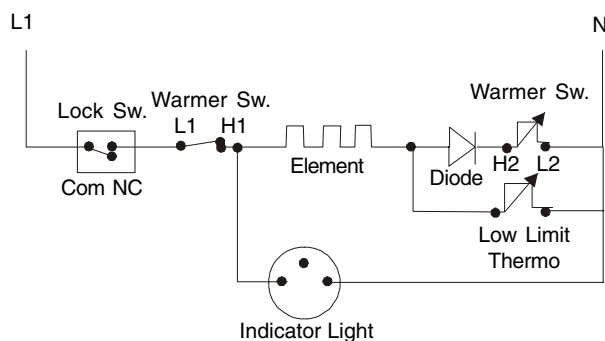

Preheat or the first cycle is controlled by the low limit thermostat which is set to open at about 150° F and reclose at about 140° F. The low limit thermostat is connected electrically in parallel with the diode and

cycling contacts of the warmer switch. No matter where the warmer knob is set during the first cycle, the temperature will always go to about 150° F. After the first cycle and during the holding cycles, the warmer drawer temperature is controlled by the cycling contact of the warmer drawer switch. The diode is placed in the circuit to lower the power to the element by about 30% during the holding cycles. This allows the warmer drawer to operate at a lower temperature during the hold cycle.

Troubleshooting:

There are five ways a warmer drawer control system can fail with a standard infinite switch:

1. The element does not heat.
2. The element heats during preheat, then stays off until the temperature drops to about 130° F.
3. The switch does not cycle the element off in the hold cycle.
4. Slow preheating.
5. The element operates correctly, but the indicator light does not glow.

If the element does not heat:

1. Check to see if the indicator light is glowing. If the indicator is not glowing remove the back panel of the backguard and measure the voltage drop between terminal L1 on the switch to neutral. If the meter reads zero, the lock switch or the wiring to the lock switch is open. If the meter reads line to neutral voltage (120 VAC) go to step 2.
2. Turn the switch on and measure the voltage drop between terminal H1 on the switch and neutral. If the meter reads zero the switch is defective. If the meter reads line to neutral voltage, the indicator light or the wiring to the indicator light is defective. Correct the indicator light problem and go to step 3.
3. Remove the warmer drawer and measure the voltage drop across the terminals of the element. If the meter reads line to neutral voltage the element is defective. If the meter reads zero go to step 4.
4. Measure the voltage drop from each terminal of the element to neutral. If the meter reads zero on both terminals the wire from terminal H1 on the switch to the element is open. If the meter reads line to neutral voltage, check the wiring to the low limit thermostat, the diode, and the cycling portion of the warmer switch. If the wiring is good, the low limit thermostat is defective, and either the diode or the switch is also defective.

If the element heats during preheat, then stays off until the temperature drops to about 140° F:

1. Check the diode and the cycling portion of the warmer switch.

If the element does not cycle off:

1. Remove one wire from the low limit thermostat and set the warmer switch to low. If the element cycles after the drawer has warmed up the low limit is defective, if it does not the warmer switch is defective. It is also possible for a wire on the neutral side of the element to be shorted to chassis.

If the warmer drawer is slow preheating:

1. Normal preheat time is around 15 minutes with the drawer empty. Check the low limit thermostat. If the contacts are open, replace the thermostat.

If the warmer drawer heats, but the indicator light does not glow:

1. Check the indicator light and the wiring to the indicator light. (Note: Indicator light does not cycle with the element.)

SECTION E - 30" DISASSEMBLY AND REPLACEMENT OF PARTS

Note: To reinstall parts, reverse all procedures.

Top trim on backguard area:

The top trim is hinged at the rear and snaps over the end panels in the front. When the trim is raised the 15 amp fuse, fluorescent lamp starter, regular outlets, oven light switch and fluorescent lamp switch are exposed.

Removing the 15 amp fuse:

1. Raise the front of the top trim and turn the fuse counter clockwise.



15 amp fuse

Removing the fluorescent lamp starter:

1. Raise the front of the top trim and turn the starter about an 1/8 of a turn counter clockwise and lift it out.



Starter

To disconnect the wires from the outlets and the oven and fluorescent switches it is necessary to roll control mounting panel forward.

To roll the control mounting panel forward:

1. Disconnect power from the range and obtain access to the rear of the range.
2. Remove the five screws holding the control mounting panel to the back panel of the range and the two screws holding the end caps to the back panel of the range. Lift the backguard up and roll it forward.

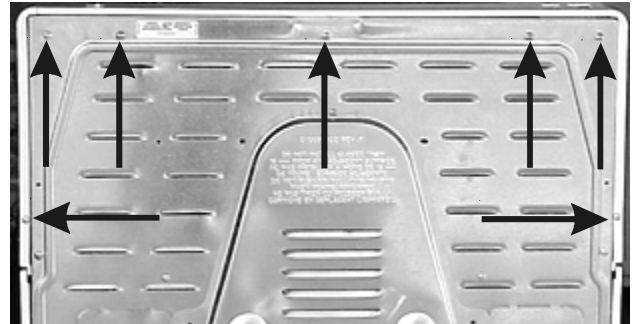

Seven screws

Removing the 120 volt outlet:

1. Disconnect power from the range, raise the top trim, roll the control mounting panel forward and disconnect the wires to the outlet.
2. The outlets, one on each side, are mounted to brackets that are held to the top of the control mounting panel by tabs and slots on one end and a screw on the other. Remove the screw and slide the bracket sideways.

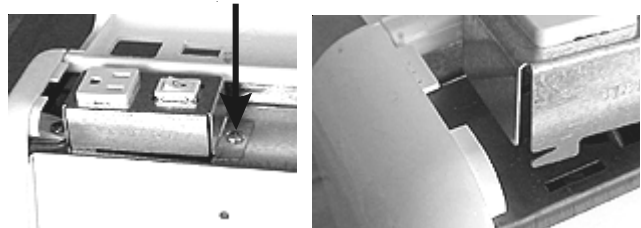

Screw

Tabs and slots

3. The outlet is held in the bracket by spring loaded tabs. To remove the outlet from the bracket squeeze the tabs and pull outlet out of the bracket.



One tab on each side

Removing the oven light or fluorescent switch:

The oven light switch and the fluorescent lamp switch are mounted in the brackets that hold the outlets.

1. Disconnect power from the range, raise the top trim, roll the control mounting panel forward and disconnect the wires from the switch.
2. The switches are mounted to brackets that are held to the top of the control mounting panel by tabs and slots on one end and one screw on the other. Remove the screw and slide the bracket sideways.



Screw

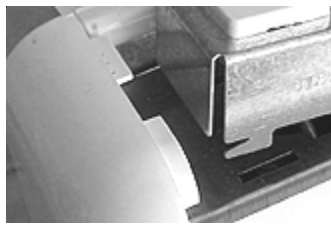

Tabs and slots

3. The switch is held in the bracket by spring loaded tabs. To remove the switch from the bracket squeeze the tabs and pull switch out of the bracket.



One tab on each end

Removing the top trim:

1. Raise the front of the trim and slide the trim back off of the pins on the end cap.

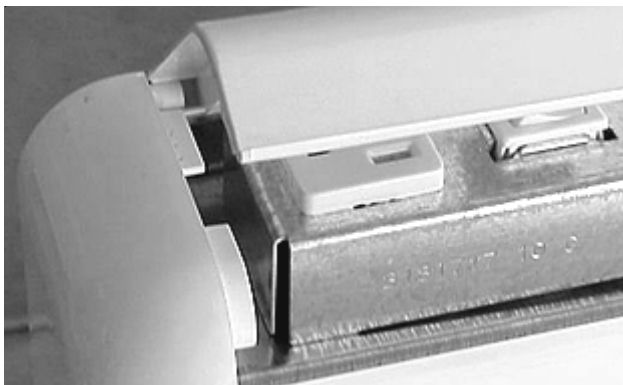

One tab on each end

Removing the knobs:

1. The top element, oven selector and oven thermostat knobs pull off.



Removing the backguard glass:

The backguard is held in place by a channel in the bottom trim and the lip of the top trim.

1. To remove the glass, remove the knobs, pull the top of the glass forward and lift the glass out of the channel.



Channel

Removing the timer: (models with thermostats)

1. Disconnect power and remove the control panel glass.
2. The timer or control is held to the control mounting panel by two brackets. To remove the timer or control

remove the two screws holding the brackets to the control mounting panel. Pull the timer or control forward then mark and disconnect the wires.

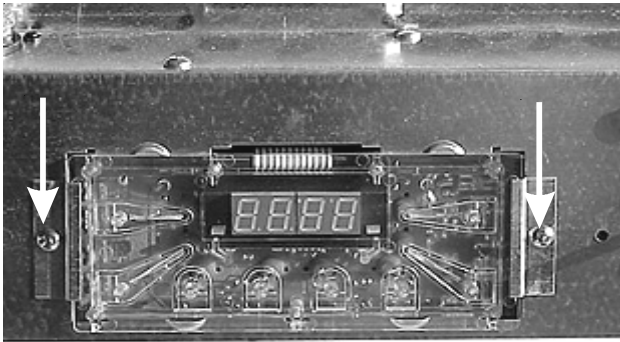

Two brackets and screws

Removing electronic oven control:

1. Disconnect power and roll the control mounting panel forward.
2. Mark and disconnect the wires to the control.
3. Remove the four screws holding the electronic oven control to the control panel (one in each corner).



Back view of electronic oven control

Top element switches:

1. Disconnect power and roll the control mounting panel forward.

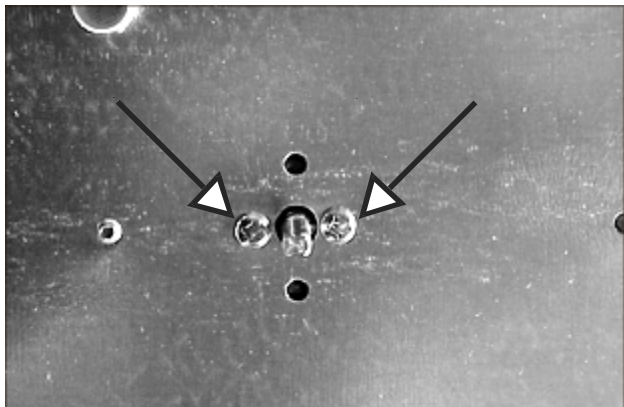

Two screws

2. Mark and disconnect the wire from the switch.
3. Remove the two screws holding the switch to the control mounting panel and pull the switch backwards.

Oven selector switch: (models with oven thermostats)

1. Disconnect power and roll the control mounting panel forward.
2. Mark and disconnect the wire from the switch.

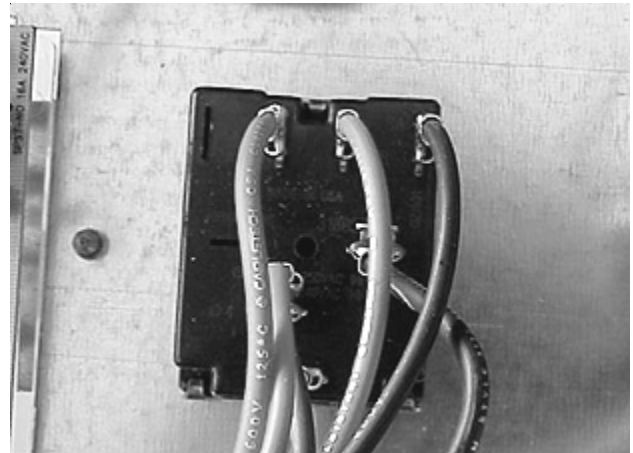

Back of switch

3. Remove the two screws holding the switch to the control mounting panel and pull the switch backwards.

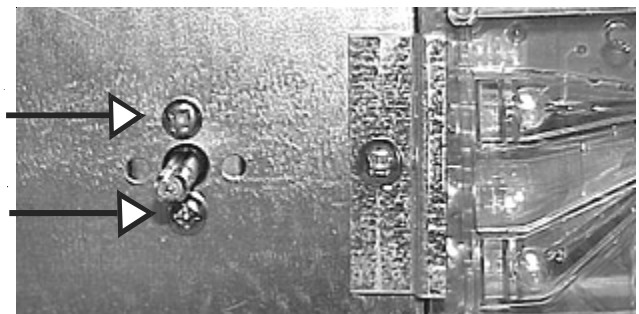

Two screws

Oven thermostats:

1. Disconnect power and roll the control mounting panel forward.
2. Mark and disconnect the wire from the thermostat.

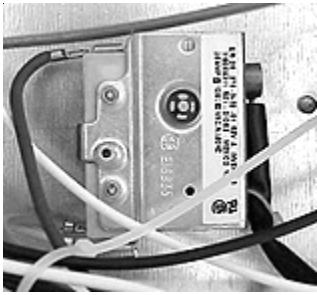

Back of thermostat

3. Remove the two screws holding the thermostat to the control mounting panel.

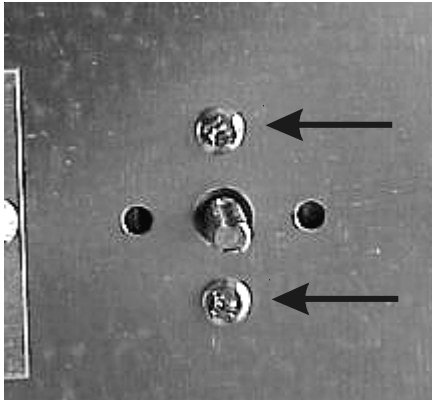

Two screws

4. Remove the large rear panel by removing three screws and lifting the panel out of the tabs.

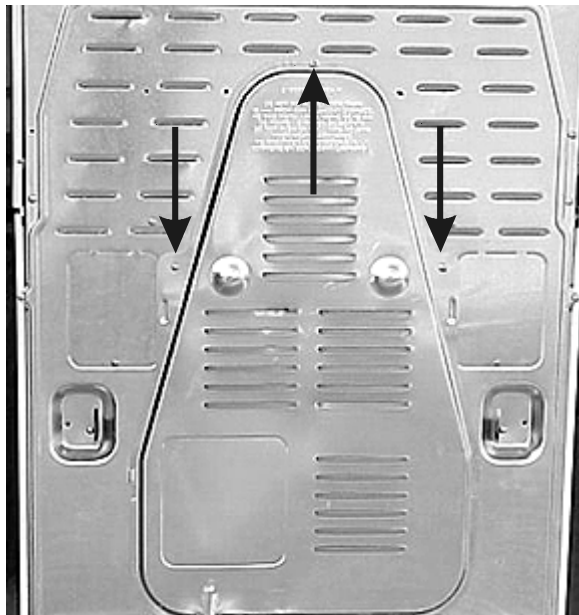

Remove three screws

5. Remove the small cover from the rear of range by removing one screw and pulling down.

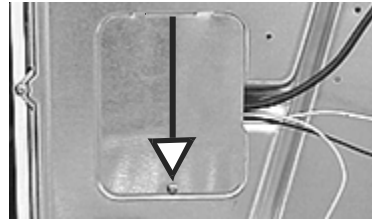

One screw

5. Unclip the thermostat bulb inside the oven and pull the bulb out the rear of the range.

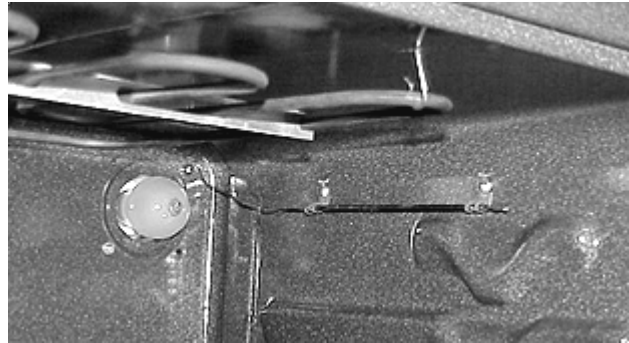

Thermostat bulb

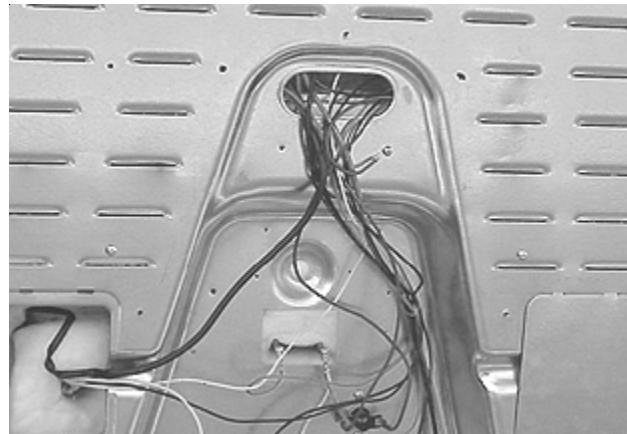

Rear of range with panels removed

Removing the large element safety thermostat:

1. Disconnect power and roll the control mounting panel forward.
2. Disconnect the wires from the safety thermostat and remove the two screws holding the thermostat to the control mounting panel.

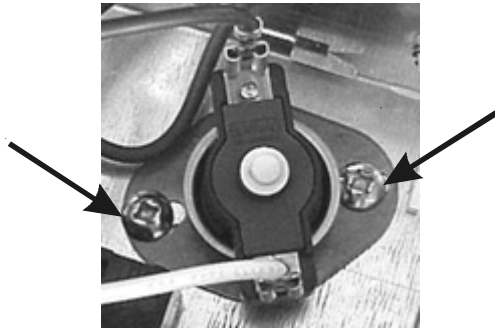

Two screws

Removing indicator lights:

1. Disconnect power and roll the control mounting panel forward.
2. Disconnect the wires from indicator light and squeeze the tabs on the sides of the light and push it through the control mounting panel.

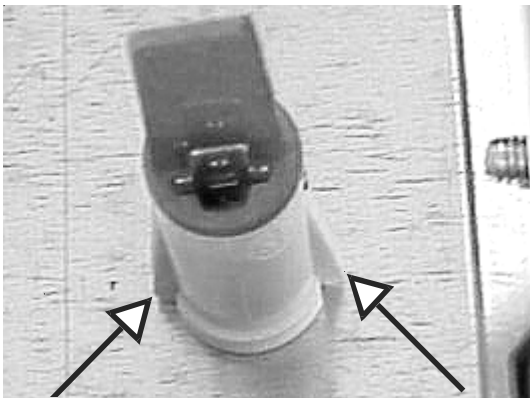

Two tabs

Removing the fuse socket:

1. Disconnect power and roll the control mounting panel forward.

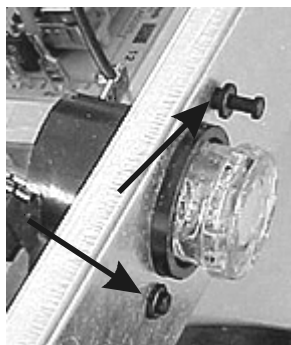

Locking pins and rivets

2. Disconnect the wires from fuse socket, pull the plastic locking pins from the plastic rivets and remove the rivets.
3. Lift the socket out of the control mounting panel.

Removing fluorescent starter socket:

1. Disconnect power and roll the control mounting panel forward.
2. Disconnect the wires at the fluorescent light socket using a flat blade to release the wire from the socket.



Use a flat blade

3. Remove the starter from the socket and squeeze the sides of the socket to release it from the control mounting panel.



Socket

Removing terminal block:

1. Disconnect power and roll the control mounting panel forward.
2. Mark and disconnect the wires.
3. Using a 3/8" socket remove the two nuts and bolts holding the terminal block to the control mounting panel.

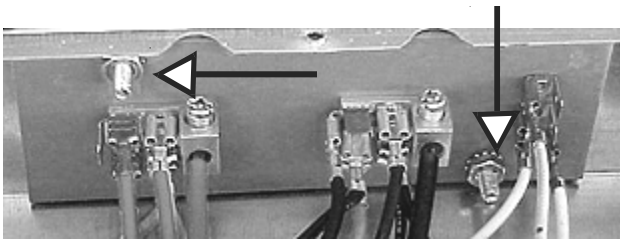

Terminal block

Removing the end caps:

1. Disconnect power and roll the control mounting panel forward.
2. Remove one screw from the top and one screw from the inside which prevents the end cap tabs from releasing from the control mounting panel. Lift the end cap up and off.

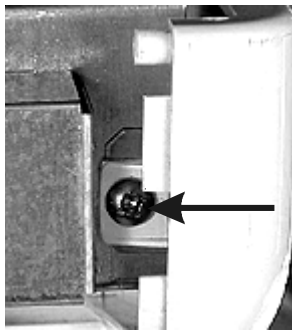

Top



Inside

Removing the bottom glass trim:

1. Disconnect power and remove one end cap.
2. Remove the two screws holding the trim to the control mounting panel.

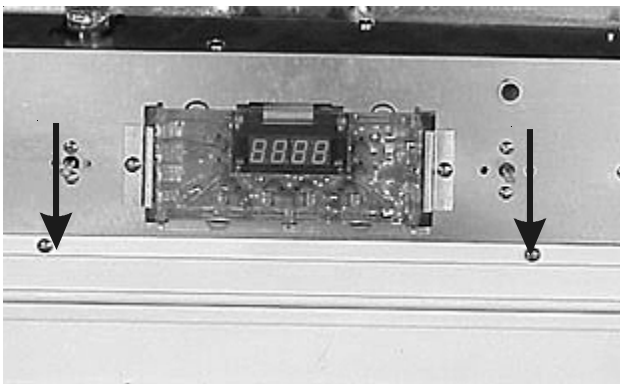

Two screws

Removing fluorescent light socket:

1. Disconnect power, roll the control mounting panel

forward and remove the bottom glass trim.

2. Squeeze the tabs on the sides of the socket and push it through the control mounting panel.

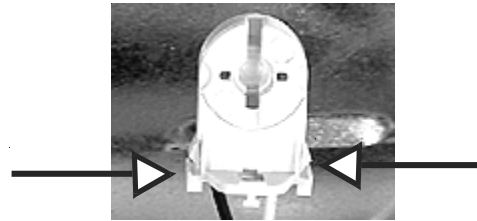

Tab on each side

Main top area:

Removing coil elements and drip pans:

1. Raise the end of the element about an inch and pull the element out. The drip pan then lifts out.



Element and drip pan

Raising main top: (smooth top models)

1. Disconnect power and open the oven door.
2. Remove the two screws holding front of the top to the front frame and lift the front of the top up.

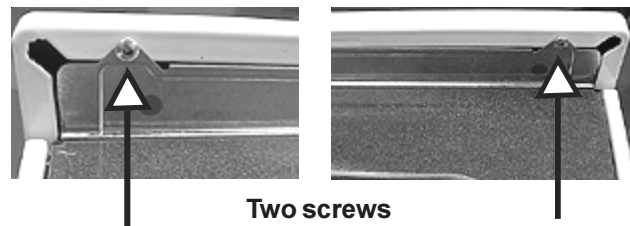

Two screws

Removing the elements: (Smooth top models)

1. Disconnect power and raise the main top.

- The elements are held against the glass by two bars, one for the two front elements and one for the two back elements.
- The bar is held to the main top by two screws on one end and a tab on the other. Remove the two screws and swing the bar down.

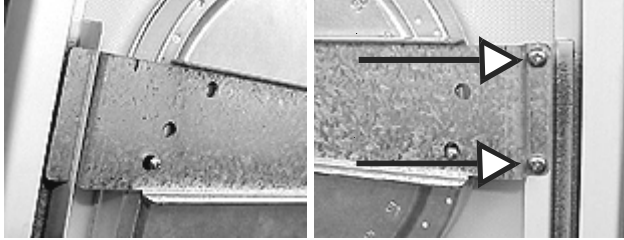

Tab

Two screws

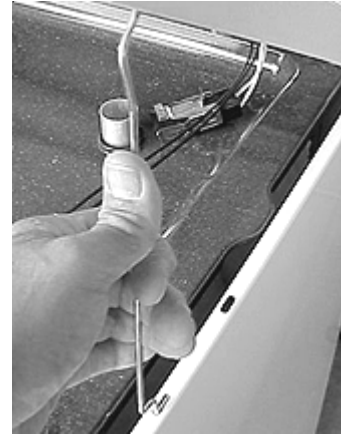

Bend rod

- Mark and disconnect the wires.

Terminal block:

- Disconnect power and remove the element and drip pan.
- Remove the one screw holding the terminal block to the main top.

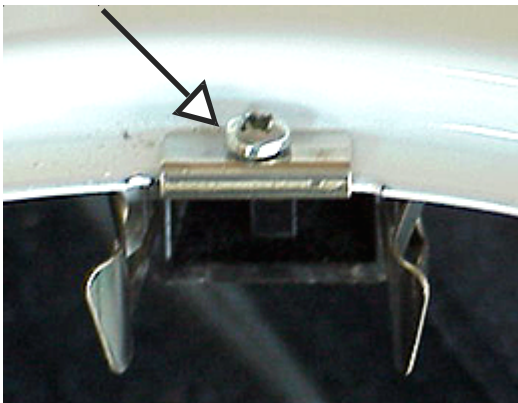

One screw

Note: When replacing the terminal block the replacement terminal block will have two short leads and ceramic wire nuts.

Removing the main top lift and lock rods on coil element models:

- Raise the main top and bend the rod to release it from the bodyside.

- Release the rod from main top pushing back on the rod to disengage it from the front slot and then tip the rod to the side and remove it from the rear slot.



Slots in main top

- When reinstalling the lift and lock rod, insert the rod in the rear slot, then tip the loop of the rod so that it goes into the raise part of the top. Install the rod into the front slot.



Loop

Removing the main top: (Coil element models)

1. Disconnect power, remove the elements and drip pan.
2. Disconnect the terminal blocks and remove the lift and lock rods.
3. Raise the front of the main top and push the main top hinge bracket toward the side of the range to disengage the hinge pin. Pull forward and to the side on the top and slide the other hinge pin out of its bracket. Disconnect the ground wire and remove the top.



Hinge bracket

Removing the main top: (smooth top models)

1. Disconnect power, and raise the front of the top.
2. Remove the element bars and drop the elements down.
3. Push the main top hinge bracket toward the side of the range to disengage the hinge pin. Pull forward and to the side on the top and slide the other hinge pin out of its bracket. Disconnect the ground wire and remove the top.



Hinge bracket

Removing the lock rod: (self clean models)

1. Raise the front of the main top and remove the screw holding the rod to the spring and sleeve. Pull the rod out the front of the range.

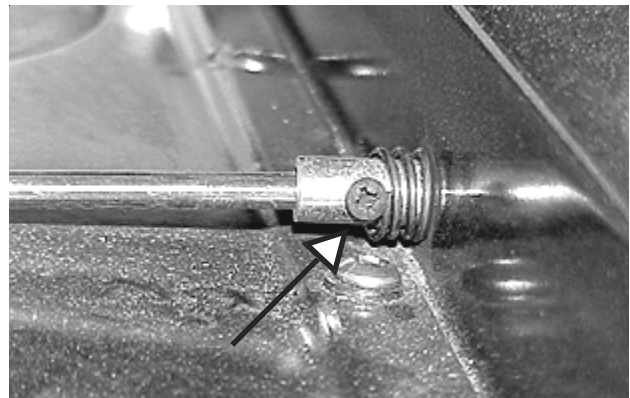

One screw

Removing the main top hinge:

1. Disconnect power, disengage the lift and lock rods (Coil models), disconnect the hinge from the hinge plate and pull the top forward.
2. Remove the two screws holding the hinge to the flange of the main top.

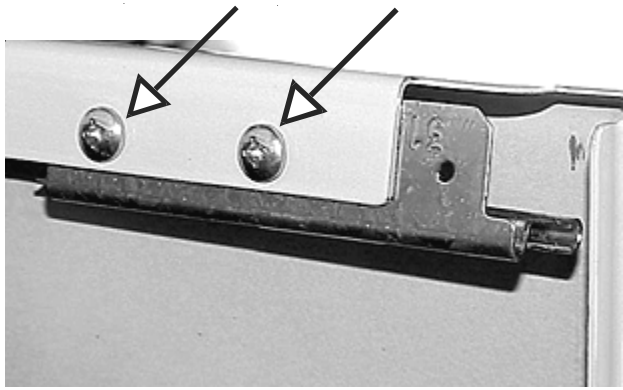

Two screws

Removing the burner pan: (coil models)

1. Disconnect power and raise the main top.
2. Remove the three screws holding the burner pan to the front frame.

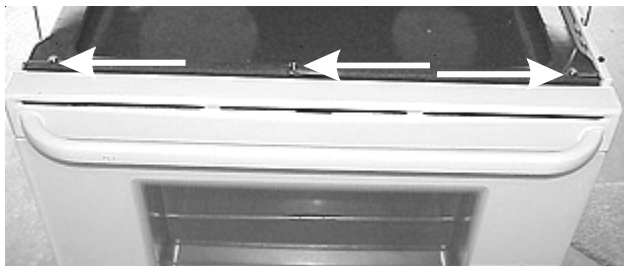

Three screws

3. Remove the two screws from the rear of the range holding the burner pan to the rear of the range and the oven vent from inside the oven.



Two screws

4. Remove both bodysides and remove the two screws on each side that hold the burner pan to the front frame and the rear panel.

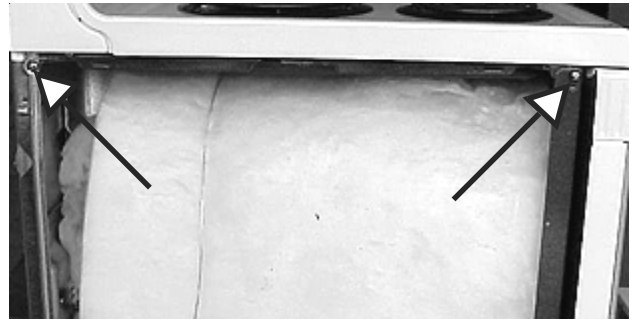

Two screws

Oven door area

Removing the oven door seal:

1. The oven door seal is held to the inner door liner by spring clips.

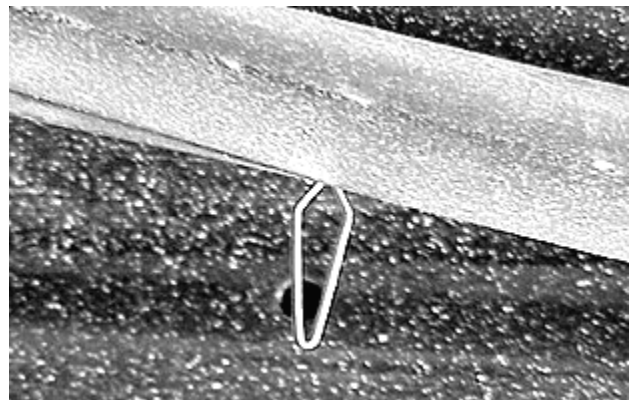

Clip

2. To remove the seal place a flat blade screw driver between the seal and the liner beside the clip and lift the screw driver.

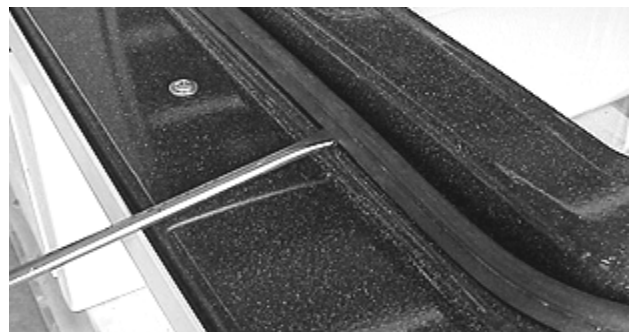

Screw driver

Note: Door seal shown is for a non self-clean model, use the same procedure for self-clean models.

Note: Be careful not to scratch the liner.

Removing the oven door:

1. Open the oven door completely and lock the hinges with the hinge lock.
2. Raise the top of the door and at the same time roll the bottom of the door and the hinges out of the front frame.

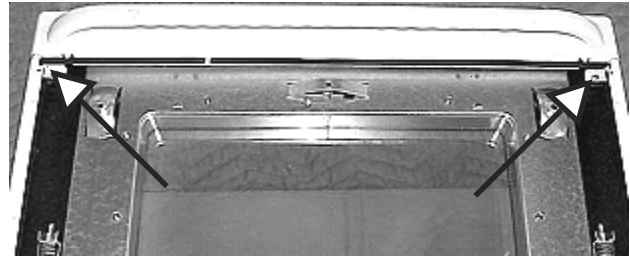

Two screws

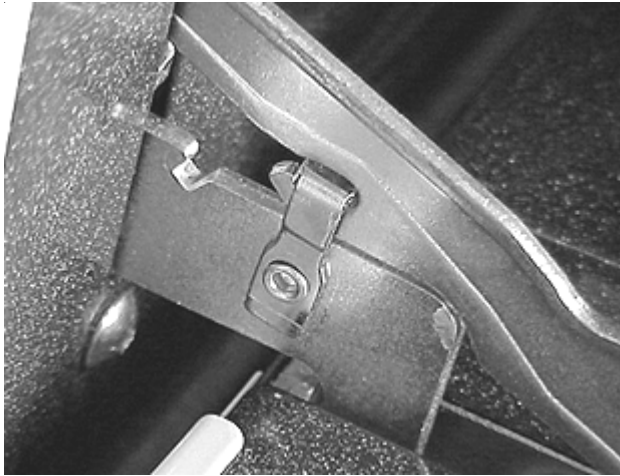

Hinge lock

Removing the door handle:

1. Remove the outer glass and top trim.
2. Remove the two screws holding the handle to the trim.

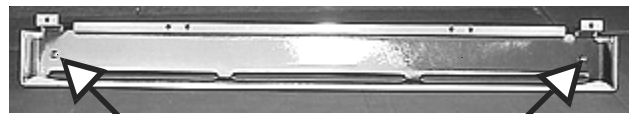

Two screws

Removing the side trim:

1. The trim is held to the side by a tab at the top of the trim and one screw at the bottom of the door. Remove the screw and slide the trim down.

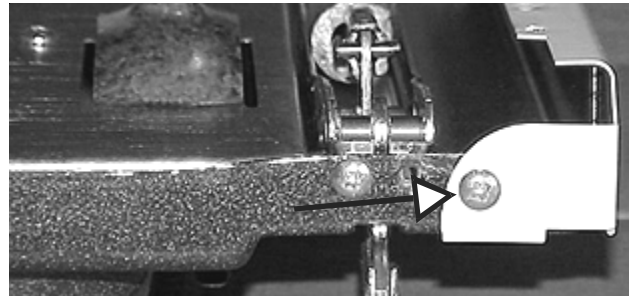

One screw

Removing the bottom trim and outer door glass:

1. Remove the oven door and place it on something that will not scratch the liner.
2. Remove the five screws holding the bottom glass trim to the inner door liner and slide the glass and trim down and off.

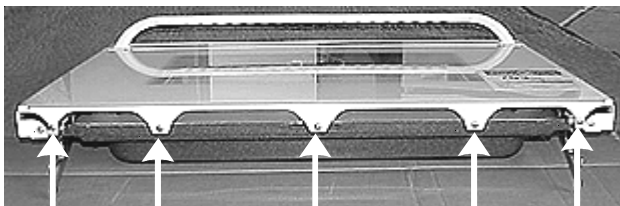

Five screws

Removing the upper door trim and handle:

1. Remove the outer glass.
2. Remove the two screws holding the upper trim to the inner door liner and lift the trim and handle off.

Removing the door hinge:

1. Remove the outer glass and lower trim. The hinge is held to the inner door liner by two screws at the bottom of the door and one screw through the inside. When the bottom trim is removed, then remove the one screw that holds the hinge to the bottom of the door.

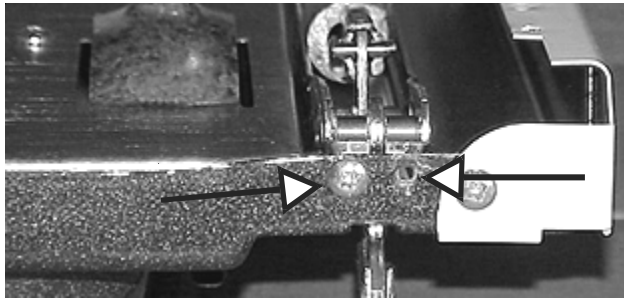

Two screws from the bottom

2. Remove one screw from front of the inner door liner and pull the hinge out.



One screw

Removing the inner door heat shield:

1. Remove the outer door glass and bottom trim.
2. Remove the six screws holding the shield to the inner glass frame and lift the shield off.

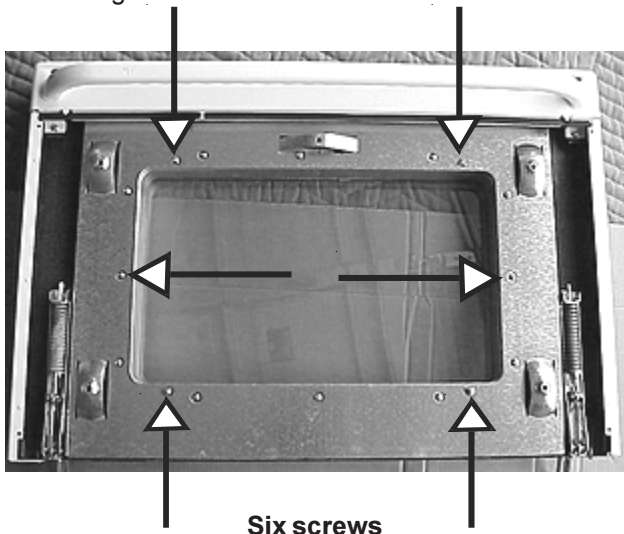

Six screws

Removing the inner door glass frame:

1. Remove the outer glass, bottom trim and heat shield.
2. Remove the six screws holding the frame to the inner liner and lift the frame off.

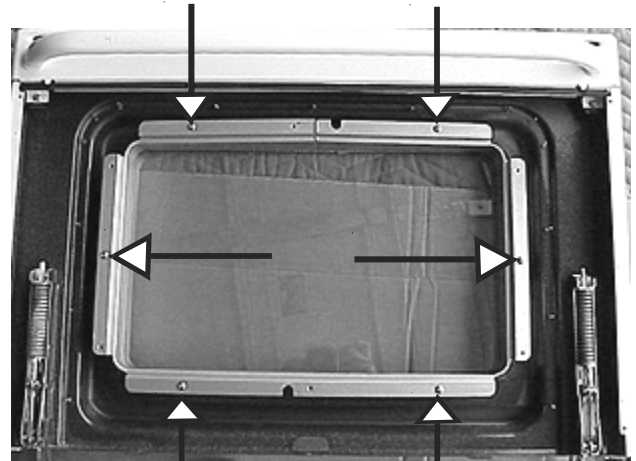

Six screws

Removing the inner door glass:

1. Remove the outer glass, bottom trim, heat shield and inner glass frame.
2. With the frame removed the inner glass will lift out.

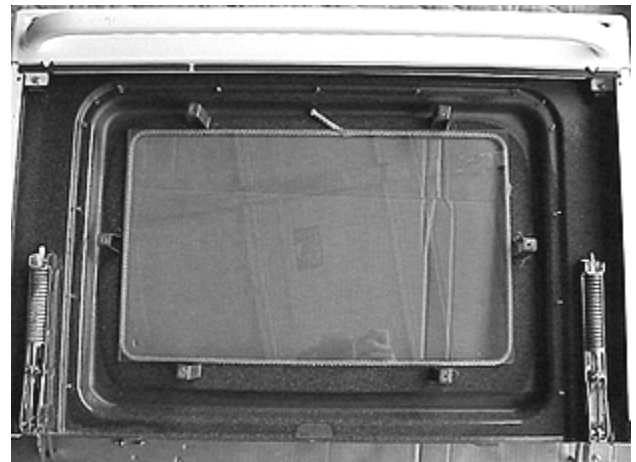

Lift glass out

Removing the inner door glass seal:

1. Remove the outer glass, bottom trim, heat shield, inner glass frame and inner glass.
2. With the inner glass removed the seal will lift out.

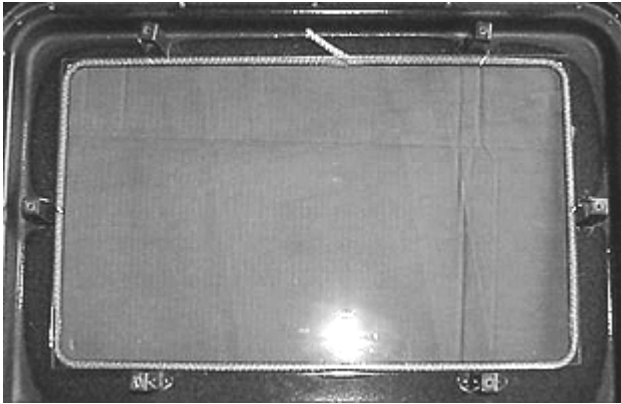

Inner glass seal

Inside the oven

Removing the bake element:

1. Disconnect power and remove the two screws that hold the element to the oven liner.
2. Pull the element into the oven and disconnect the wires.



Two screws

Removing the broil element:

1. Disconnect power and unsnap the two wire hanger from the front of the element.



Two wire hanger

2. Remove the two screws holding broil element to the liner and pull the element into the oven.

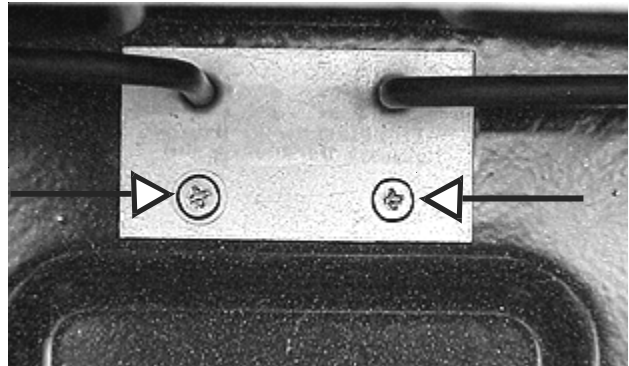

Two screws

Removing oven sensor:

1. Disconnect power and remove the large panel and small right-hand panel from the rear of the range and unplug the sensor wires.

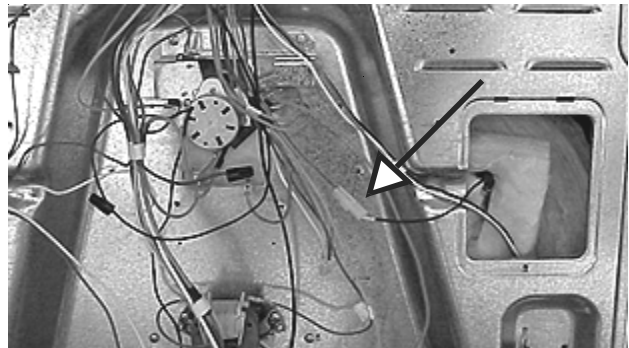

Disconnect

2. From inside the oven remove the two screws holding the sensor to the rear wall of the oven and pull the sensor into the oven.

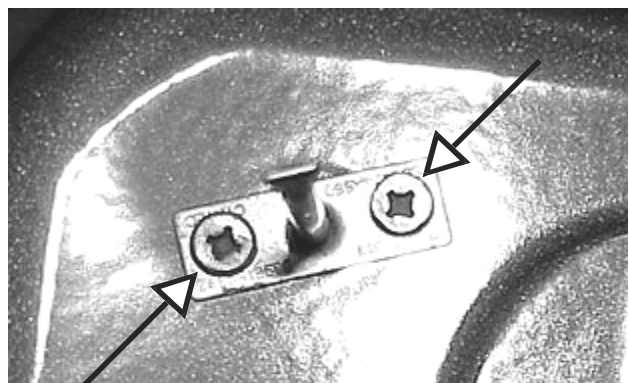

Two screws

Removing the fan blade cover on convection and speed bake models:

1. Remove the oven racks and the three screws holding the cover to the rear wall of the oven.

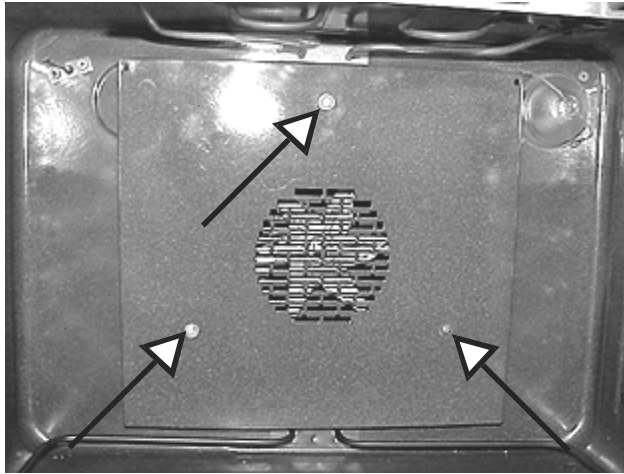

Three screws

Removing the fan blade on convection and speed bake models:

1. Remove the fan blade cover. Using a 1/2 inch wrench remove the nut holding the fan blade to the motor shaft by turning the nut counter clockwise.



1/2 inch wrench

Removing assist element on convection models:

1. Disconnect power and remove the large panel and disconnect the wires from the element.
2. Remove the one screw at the top and two at the bottom that hold the element to the rear oven wall and pull the element into the oven.

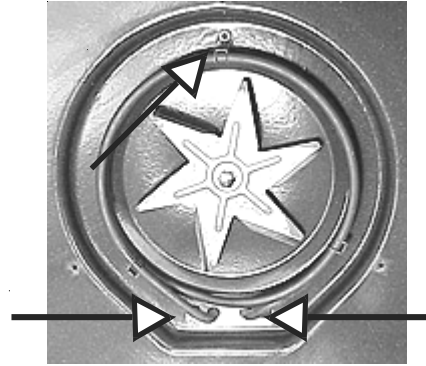

Three screws

Removing the oven vent: (coil top models and bottom part of the vent system on smooth top models)

1. The base of the oven vent is tabbed and the top of the oven liner is notched. Turn the base of the vent until the tabs line up with the notches and pull the vent into the oven.



Oven vent

Removing the upper oven vent: (smooth top models):

1. Disconnect power and raise the main top.
2. Lift the upper part of the vent up and unsnap vent from bracket mounted to the rear panel of the range.

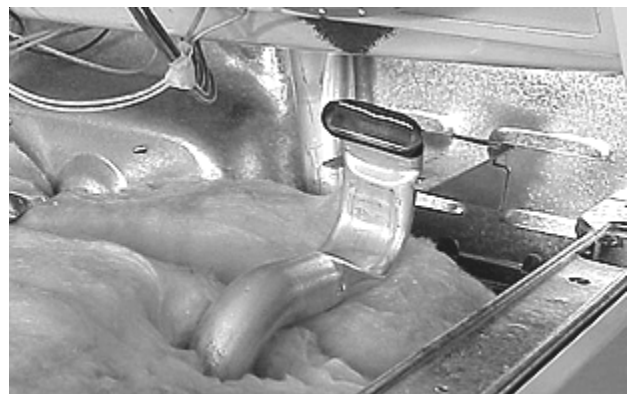

Bracket

Removing oven light shield: (self-clean models)

1. The oven light shield is held against the rear oven wall by a wire spring clip. Unsnap the wire and the shield will lift off.

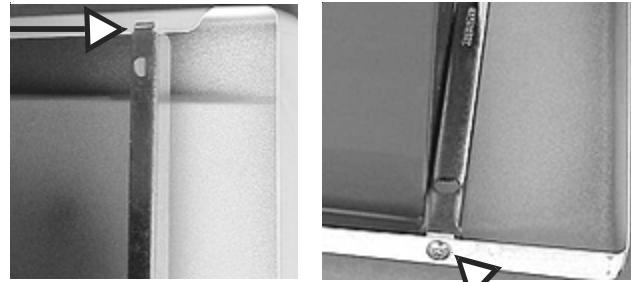
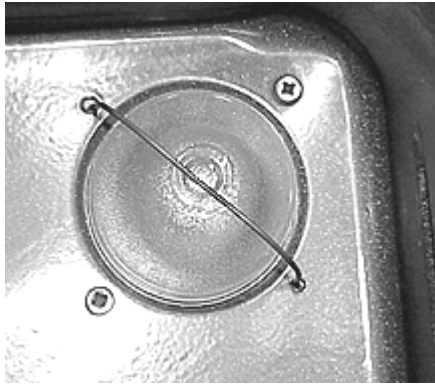

Tab

Screw

Storage drawer body:

1. The storage drawer body is held to the two braces by four screws. Remove the four screws and the braces to remove the front panel from the drawer body.

Removing the oven light socket:

1. Disconnect power and remove the small panel from the rear of the range.
2. From inside the oven remove the two screws holding the socket to the oven liner, pull the socket out the rear of the range and disconnect the wires.

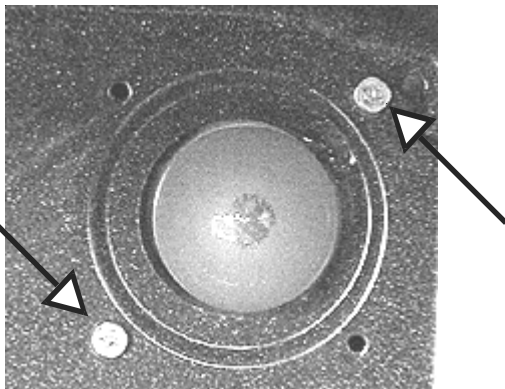

Two screws

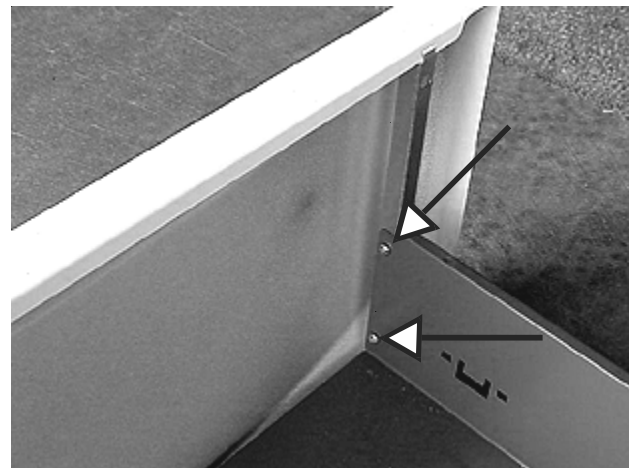

Two screws on each side

Storage drawer area

Storage drawer front panel:

1. The drawer front panel is mounted to two braces. The braces are attached to a panel tab at the top of the brace that goes into a slot in the flange of the panel, and by a screw at the bottom.

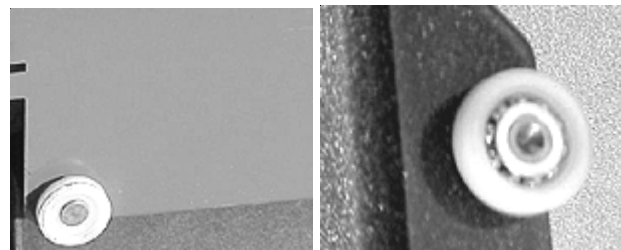

Drawer roller

Frame roller

Removing the drawer glide:

1. Each drawer glide is held to the frame by two screws. To remove a glide remove one screw in front and one at the rear and lift the glide off.

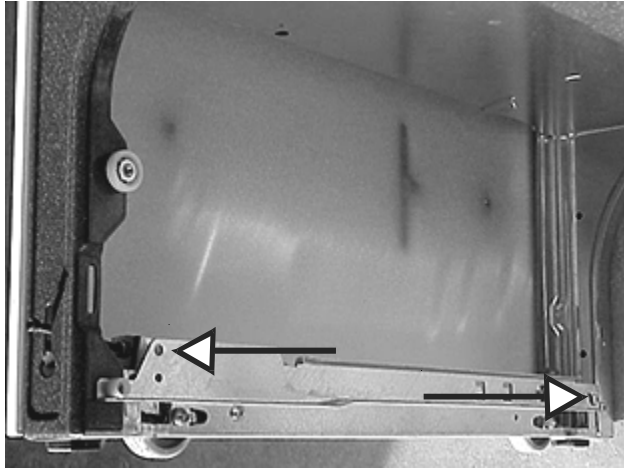

Two screws

Warmer drawer area

Removing the warmer drawer:

1. The warmer drawer has two releases. The release on the left side is visible and is released by pushing up on the end.

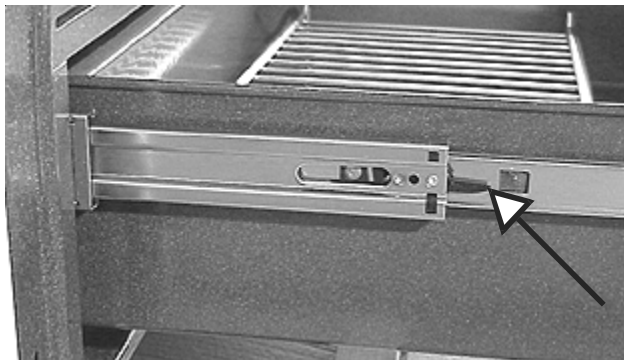

Left side release

2. The release on the right side is hidden and is released by inserting a small screwdriver above the release and pushing down.

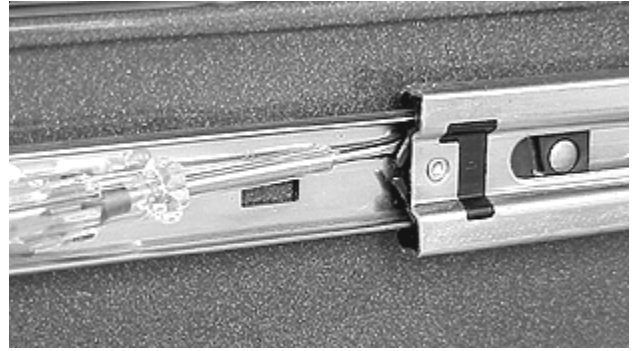

Release with a screwdriver

Removing the drawer seal:

Note: When the drawer is closed the seal will not touch the front frame of the range so that the drawer can vent.

1. The door seal is held to the inner drawer panel by spring clips. To remove, pull seal away from the panel.



Clip

Removing the outer drawer panel:

1. The outer panel is held to the inner panel by a lip at the top and two screws at the bottom.
2. Remove the drawer from the range, remove the two screws and lift up on the panel.

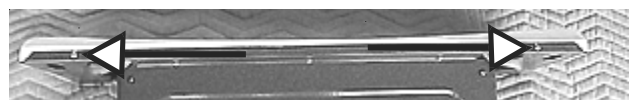

Two screws

Removing the inner drawer panel:

1. The inner drawer panel is held to the drawer body by seven screws. Two on each side and three across the bottom.

2. Remove the drawer from the range, remove the front panel, door seal, and the seven screws.



Two screws on each end

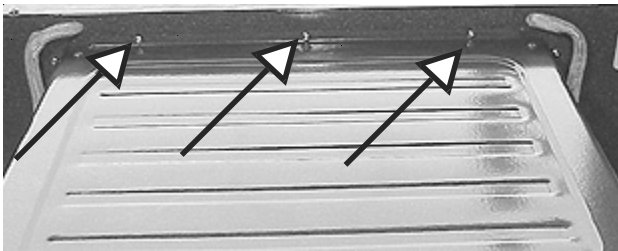

Three screws at the bottom

Removing side rail on from the drawer:

1. The side rails are held to the drawer body by two tabs that insert into the openings in the drawer and a raised dimple in the drawer body that prevent the rail from coming out of the slots.
2. To remove the drawer, push in on side of the drawer and slide the rail down.



Push in on side of drawer

Removing the drawer glides:

1. The drawer glides are held to the frame of the range by one screw in front and a tab in the rear.

2. To remove the glide, remove the drawer, remove the screw and pull the glide forward.

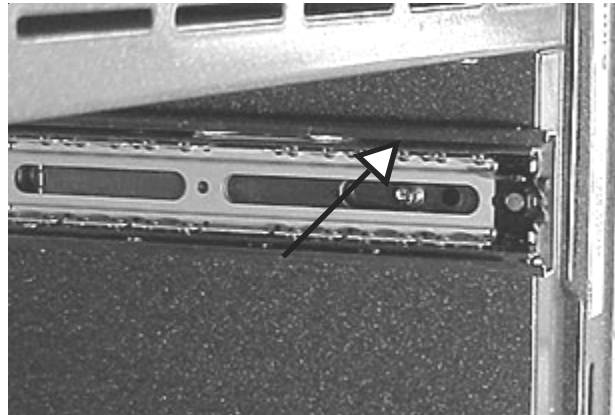

One screw

Removing the warmer drawer element:

1. Disconnect power and remove the warmer drawer.
2. Remove the three screws holding the clamps that hold the element to the bottom and the two screws holding the element to the bracket.

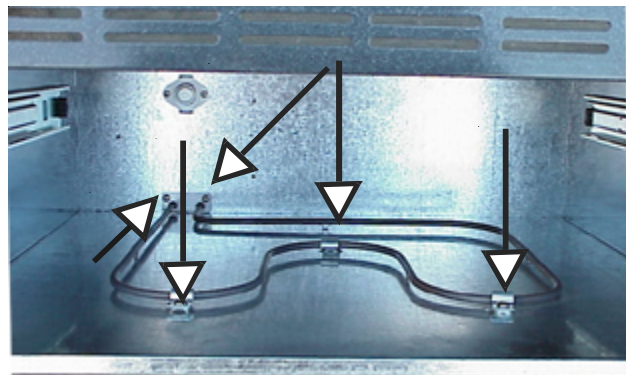

Five screws

3. Pull the element forward and disconnect the wires.

Removing the warmer drawer thermostat:

1. Disconnect power and remove the warmer drawer.
2. Remove the two screws holding the thermostat to the rear of the warmer drawer cavity, pull the thermostat forward and disconnect the wires.

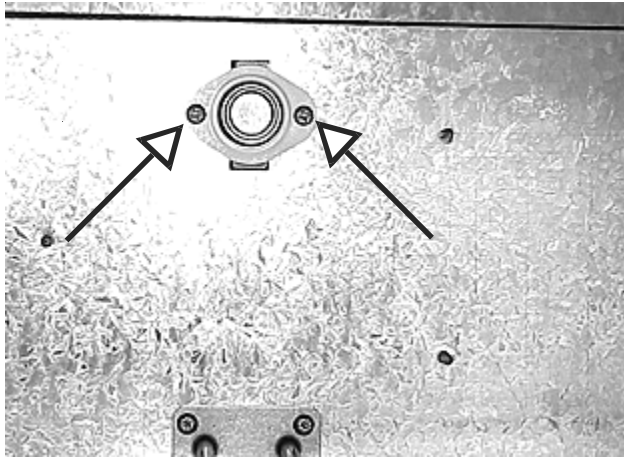

Two screws

Removing the diode and warmer element terminal cover:

1. Disconnect power and remove the three screws holding the cover to the rear of the range.

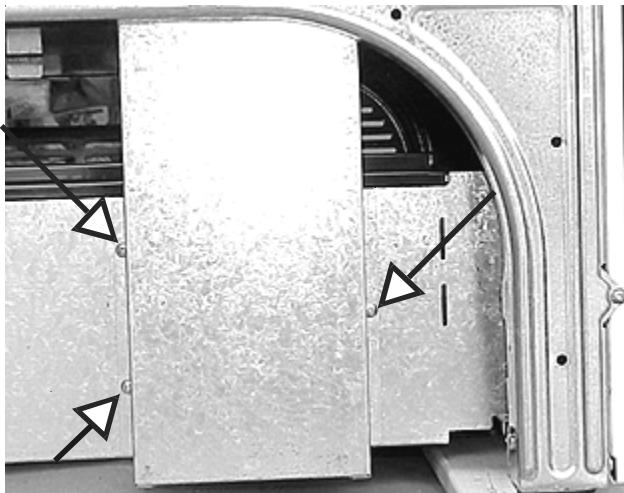

Three screws

Removing the warmer drawer diode:

1. Disconnect power and remove the diode cover.
2. Cut the wires to the diode and splice in the replacement diode.

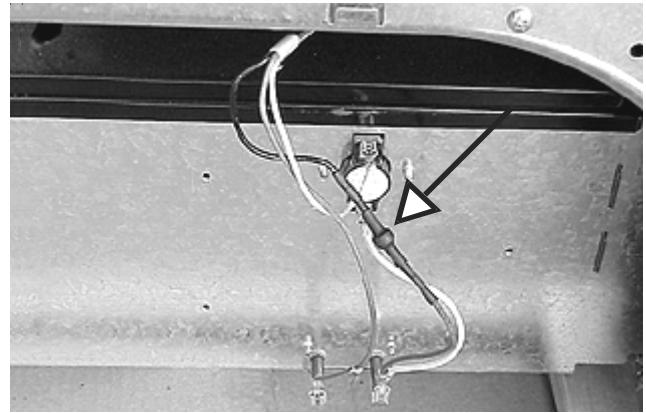

Diode

Removing the warmer drawer cavity:

1. Disconnect power, remove the warmer drawer and disconnect the wires from the element and thermostat.
2. Remove the bodysides and the four screws, two on each side one in the front and one in the rear, that hold the warmer drawer cavity to frame of the range. Pull the warmer drawer cavity out the front of the range.



Front screw

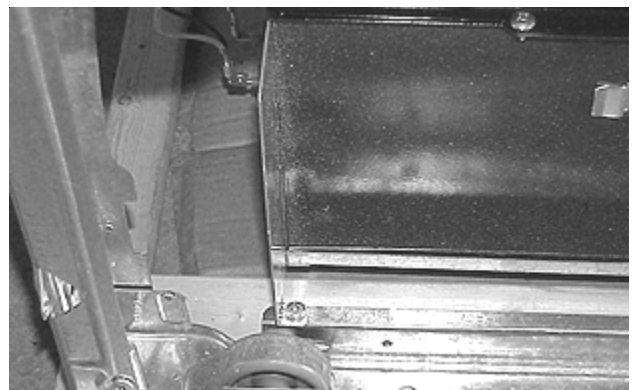

Rear screw

Removing the top of the warmer drawer cavity:

1. Remove the warmer drawer cavity from the range.
2. Remove the four screws from the top, two screws from the inside front and lift the top off.

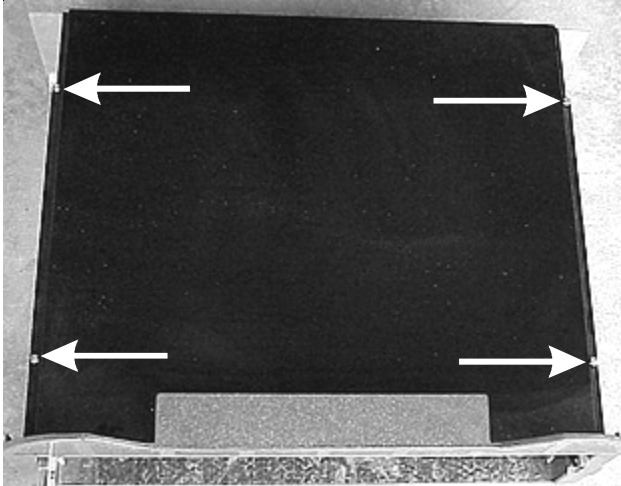

Four screws

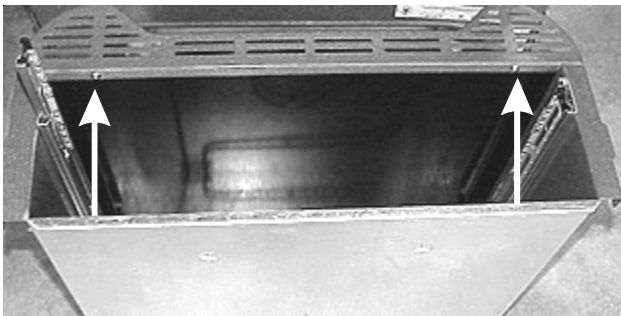

Two screws

Removing the bottom of the warmer drawer cavity:

1. Disconnect power and remove the warmer drawer.

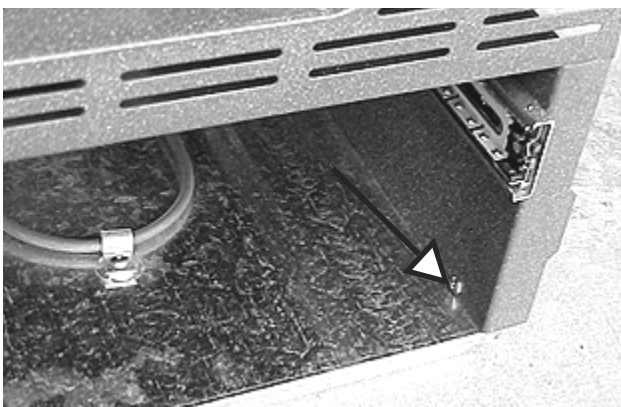

One screw in each front corner

2. Remove the three screws holding the element clamps to the cavity bottom.
3. Remove one screw in each front corner, allow the bottom to drop down, and pull the bottom forward.

Removing the front roller:

1. Remove the storage drawer glide and bend the tab that holds the roller rivet in place.
2. Raise the front of the range and pull the rivet out releasing the roller.

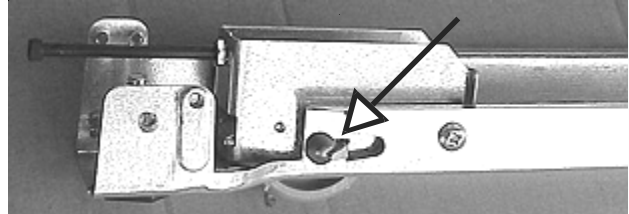

Tab and rivet

Removing the front roller bracket:

1. Remove the front roller and the screw that holds the bracket to the leveling leg and roller assembly.

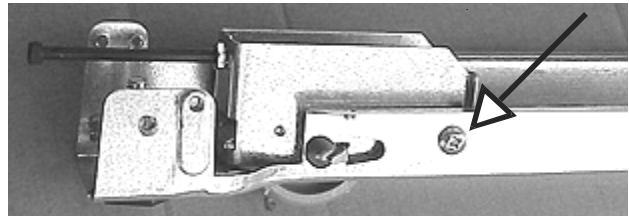

One screw

Removing the rear roller:

1. Remove the storage drawer glide and bend the tab that holds the roller rivet in place.
2. Raise the rear of the range and pull the rivet out releasing the roller.

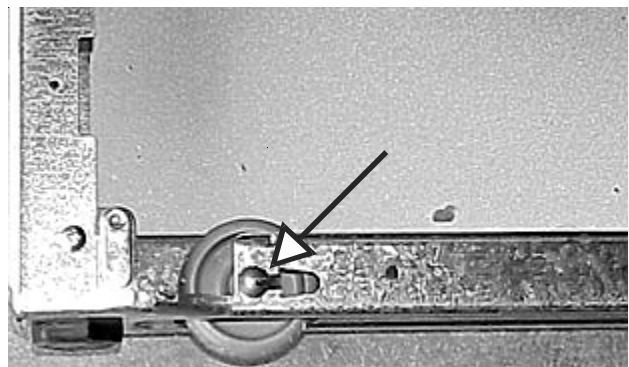

Tab and rivet

Removing the leveling leg and roller assembly:

1. Remove the storage drawer glide and the bodyside.
2. Remove the two screws from front outside corner holding the assembly to the front frame and two screws from the rear outside corner holding the assembly to the rear panel.

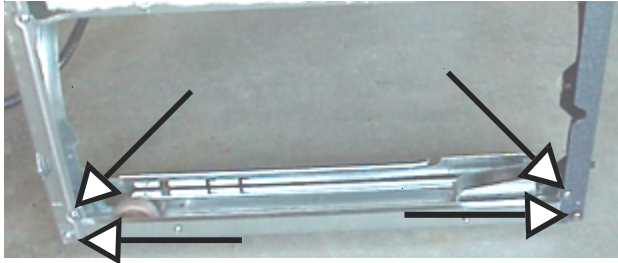

Four screws

3. Remove the one screw from the rear inside corner and lift the side of the range so the assembly can drop down.

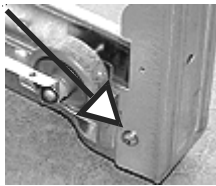

One screw

Removing the wool shield:

1. Remove the storage drawer and bodysides.
2. Remove the two screws holding the shield to the front frame.



Two screws

3. Remove two screws from each side one in the front and one in the rear and remove the wire holding the insulation against the oven.

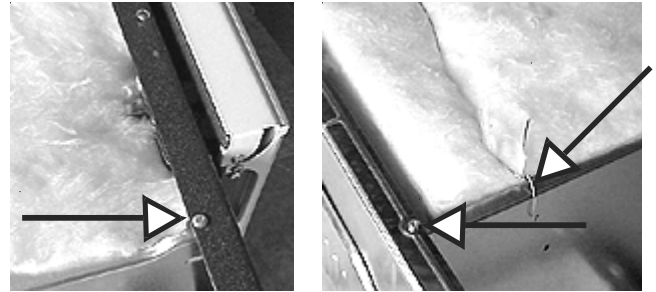

Front screw

Rear screw and wire

4. Remove the two screws from the rear of the range and pull the shield out the front.

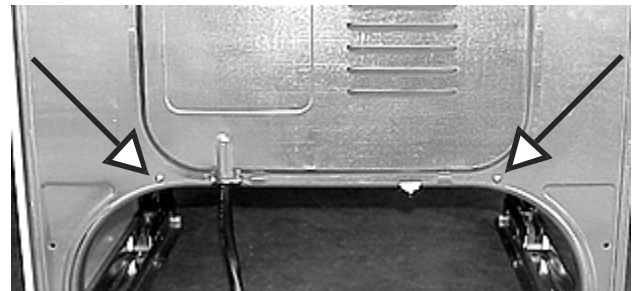

Two screws

Components mounted to the rear of the range

Removing the large rear panel:

1. Remove the three screws holding the panel to the rear of the range and lift the panel out of the two bottom slots.

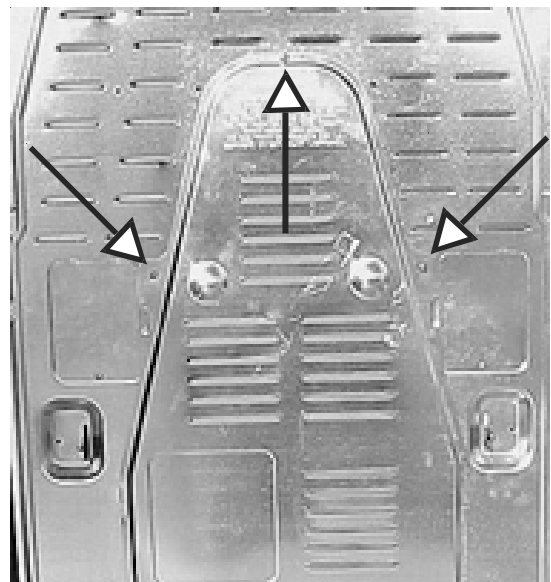

Three screws

Removing small panel:

1. The small panel is held to the rear of the range by one screw and two tabs. To remove the small panel remove the screw and slide the panel down.

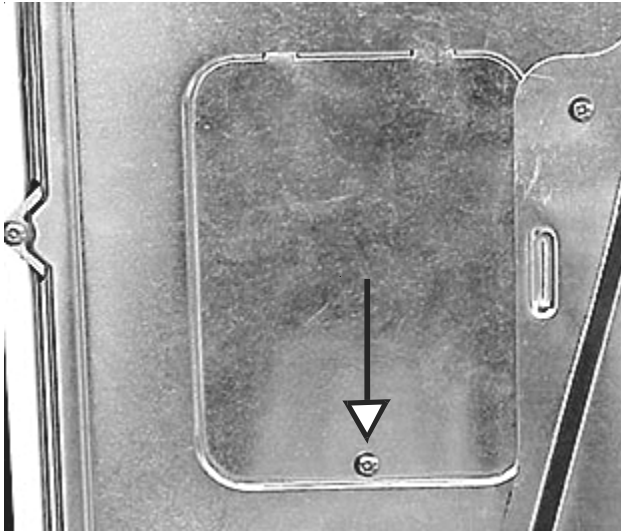

One screws

Removing the oven thermo cutout:

1. Disconnect power and remove the large rear panel.
2. Disconnect the wires to the thermo cutout and remove the two screws holding the cutout to the rear of the range.

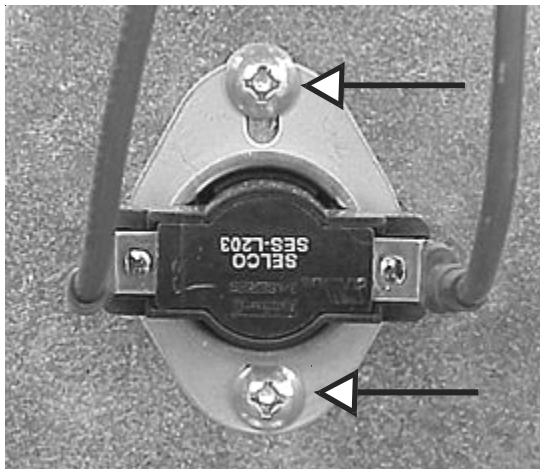

Two screws

Removing the fluorescent light ballast:

1. Disconnect power and remove the large rear panel.

2. Disconnect the wires to the light ballast, remove the one screw holding the ballast to the rear of the range and slide the ballast down.

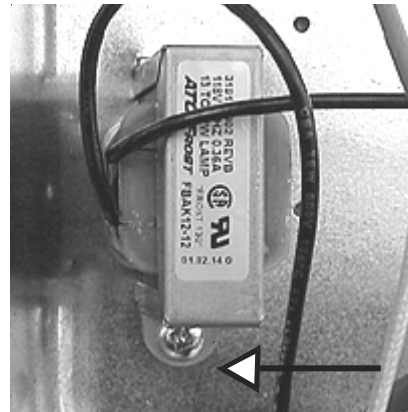

One screw

Removing the convection fan or speed bake motor:

1. Disconnect power, remove the fan cover and fan blade.
2. Remove the large rear cover and disconnect the wires from the motor.
3. Remove the three screws holding the assembly to the rear of the range.
4. Pull the motor shaft out the back of the range.
5. The fan blade is spaced on the shaft by a C clip and the cooling fan blade is held in place on the shaft by a tennamen nut

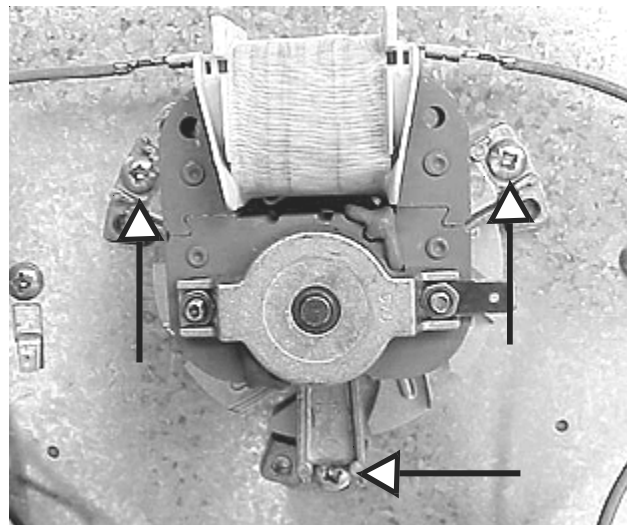

Three screws

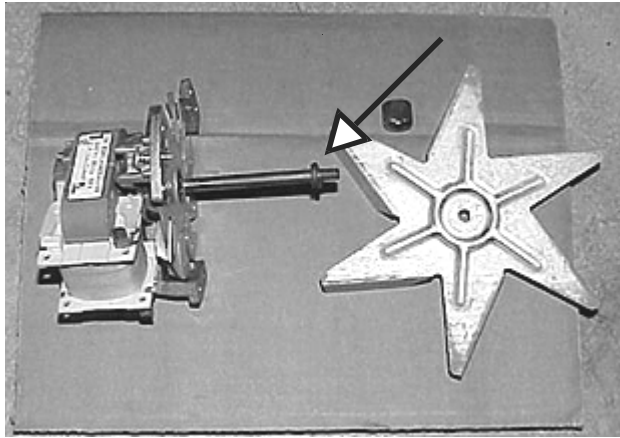

C clip shown on shaft

2. Mark and disconnect the wires from the assembly.
3. Remove the two screws holding the assembly to the rear of the range.
4. Pull back on the assembly.

Removing the power supply cord:

1. Disconnect power and remove the large rear panel.
2. Disconnect the wires to the terminals and remove the one screw holding the cord to the rear of the range.

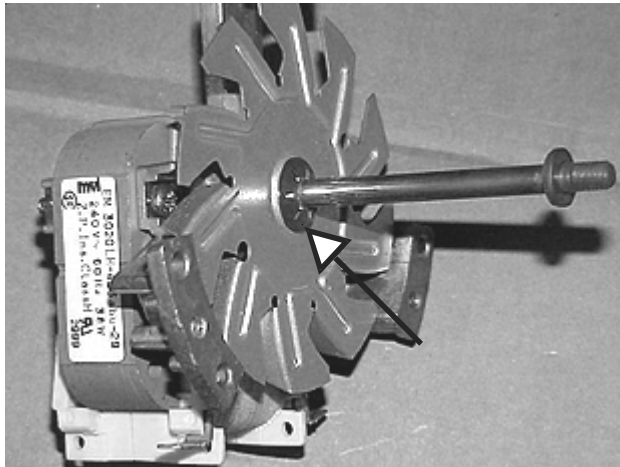

Tennamen nut

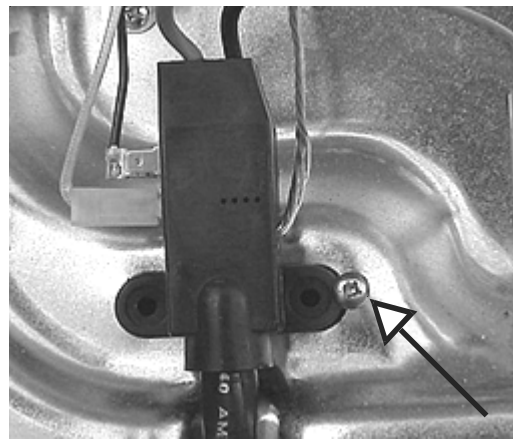

One screw

Removing the lock motor assembly:

1. Disconnect power and remove the large rear panel.

Removing the bodyside

1. Raise the main top and disconnect the lift and lock rod from the bodyside.

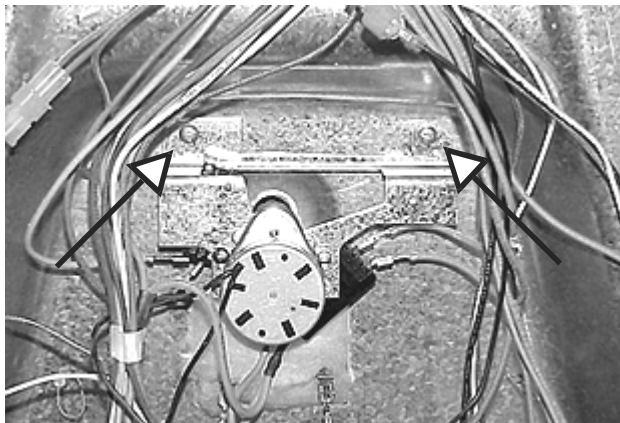

Two screws

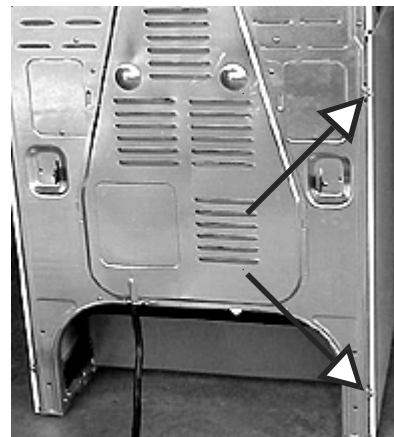

Two screws

2. Remove the two screws holding the bodyside to the rear panel. Lift the rear of bodyside to disengage it from the four shoulder screws holding the bodyside to the range frame.

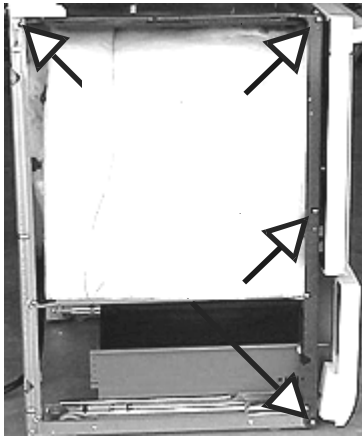

Four shoulder screws

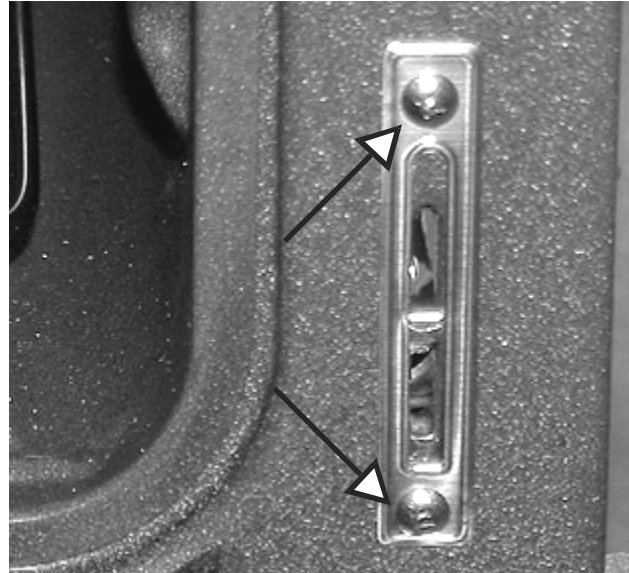

Two screws

Removing the door switch:

1. Disconnect power and remove the righthand bodyside.
2. Disconnect the wires and remove the two screws holding the switch to the heat shield.

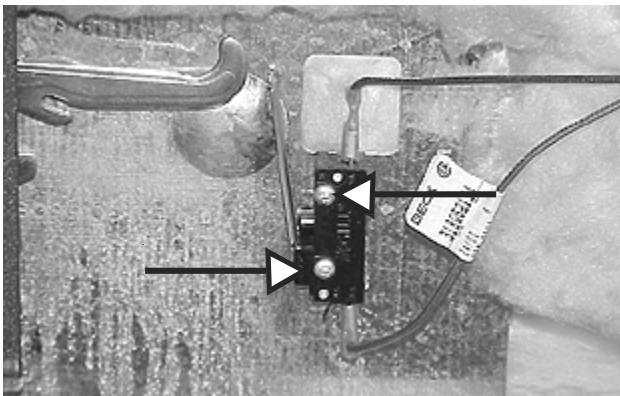

Two screws

Removing the hinge roller brackets:

1. Disconnect power and remove the oven door and the bodyside that the hinge roller bracket is on.
2. Remove the two screws holding the bracket to the front frame and remove the bracket through the bodyside opening.

SECTION E - 40" DISASSEMBLY AND REPLACEMENT OF PARTS

Note: To reinstall parts, reverse all procedures.

Top trim on backguard area:

The top trim is hinged at the rear and snaps over the end panels in the front. When the trim is raised the fluorescent lamp and fluorescent lamp starter are exposed.

Removing the fluorescent light bulb:

1. To remove the fluorescent light bulb raise the top trim and turn the bulb a quarter turn.



Removing the fluorescent light starter:

1. Raise the top trim, remove the fluorescent light bulb, turn the starter and lift it up.



Turn the starter

To obtain access to the components in the backguard remove the back panel of the backguard.

Removing backguard backpanel:

1. The backpanel is held to the range by six screws, three on each side and tabs at the bottom holding it to the rear panel of the range.
2. Remove the six screws, tip the top of the panel back and lift the panel up.

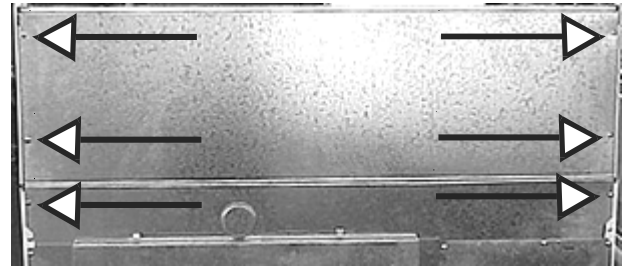

Six screws

Removing the fluorescent light socket:

1. Disconnect power and remove the backguard backpanel.
2. Squeeze the tabs on the side of the socket and push it down through the top of the control panel.

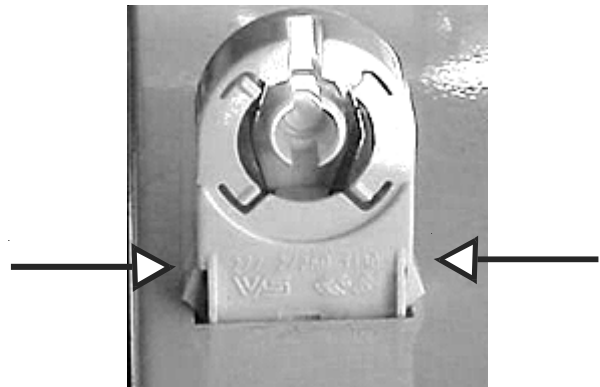

Tab on each side

3. Disconnect the wires at the fluorescent light socket by flat blade to release the wire from the socket.

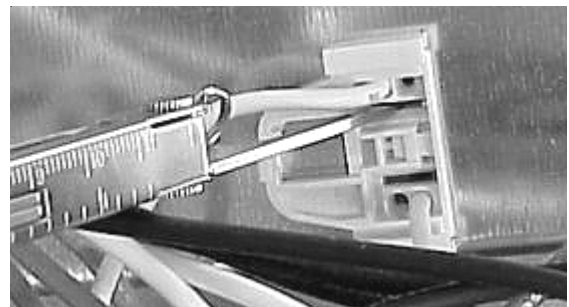

Disconnecting wires

Removing the fluorescent ballast:

1. Disconnect power and remove the backguard backpanel.
2. Disconnect the wires to the ballast and remove one screw holding the ballast to control mounting panel.

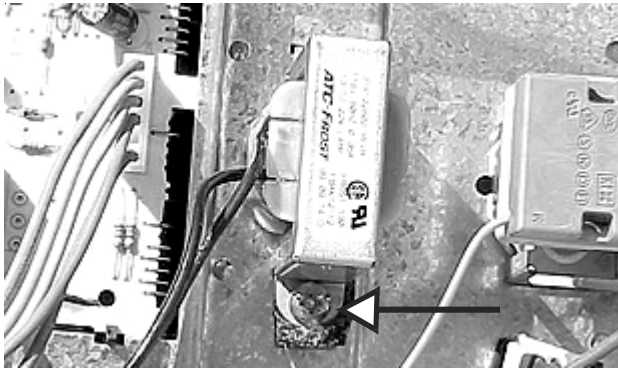

One screw

Removing the thermostat and top element knobs.

1. The knobs pull straight off.

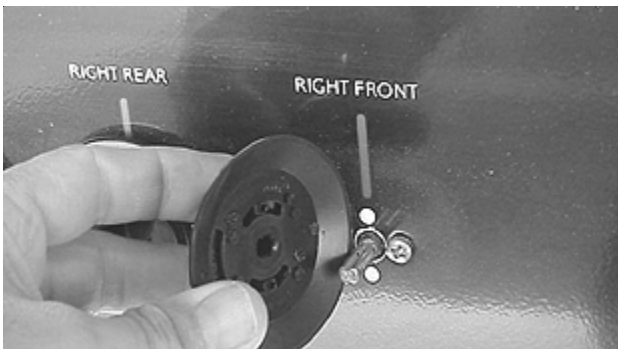

Pull straight off

Removing top element switch:

1. Disconnect power and remove the backguard backpanel.
2. Mark and remove the wires from the switch.
3. Remove the knob and the two screws holding switch to the control panel and pull the switch out the back.

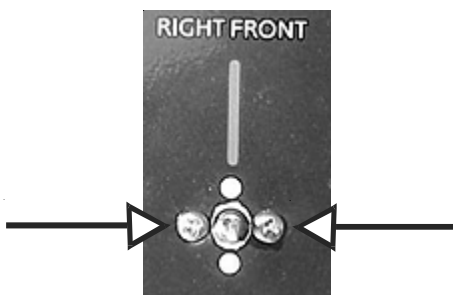

Two screws

Removing the small oven thermostat:

1. Disconnect power and remove the backguard backpanel.
2. Mark and remove the wires from the thermostat.

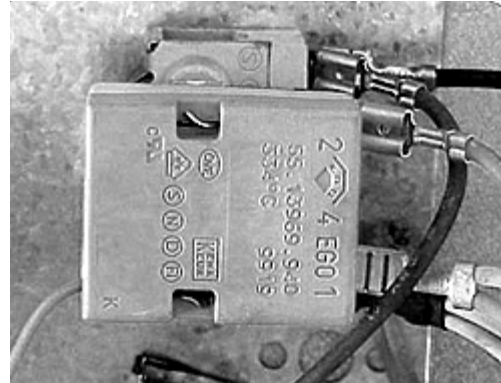

Disconnect wires

3. Unsnap the thermostat bulb from in the oven and pull it out the rear of the oven.

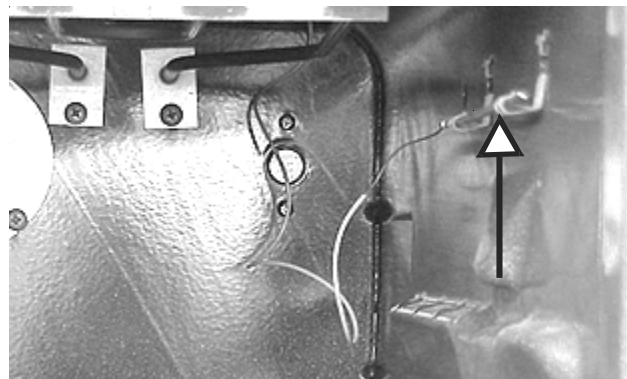

Thermostat bulb

4. Remove the knob and the two screws holding the thermostat to the control panel and remove the thermostat from the rear of the range.

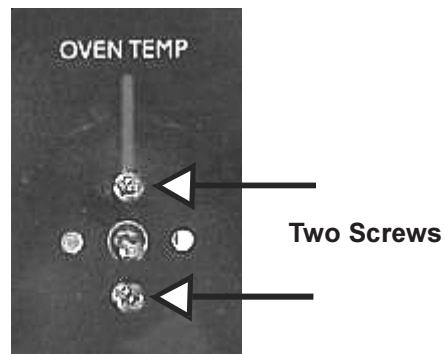

Two Screws

Removing indicator lights:

1. The indicator light snaps around the lens and is held against the control panel by spring loaded prongs.
2. Disconnect power and remove the backguard back panel. Disconnect the wires from the light and push in and slide the light off the lens.

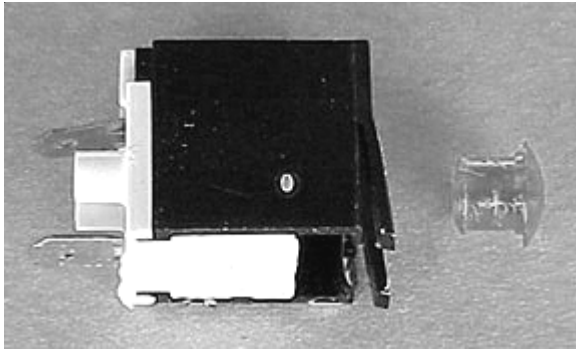

Light and lens

Removing the light switches:

1. The switches snap into the control panel from the front.
2. Disconnect the power and remove the back panel of the backguard. Disconnect the wires, squeeze the tabs on the side of the switch and push the switch out the front.

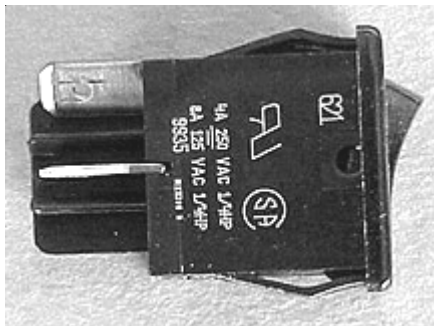

Light switch

Removing the electronic oven control:

1. Disconnect power and remove the back panel of the backguard.
2. Remove the screws holding the left front top element switch and the small oven thermostat. Disconnect the small oven indicator light from its lens. This will release the electronic oven mounting plate from the control panel.

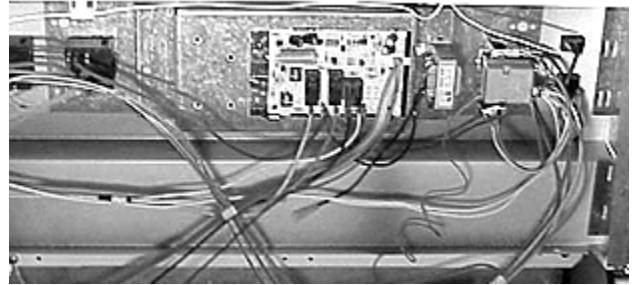

Left front switch, thermostat and indicator light

3. Mark and disconnect the wires from the electronic oven control. Remove the four screws holding the electronic oven control to the control mounting plate.



Four screws

Removing the end cap:

1. Remove the top trim and the one screw holding the end cap to the control panel. Push forward on the top of the end cap to release the tabs.

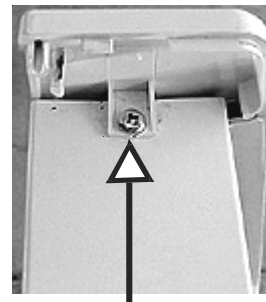

One screws

Removing the control panel end bracket:

1. Disconnect power and remove the back panel of the backguard and the end cap.
2. Remove the two screws holding the end bracket to the side panel corner bracket and pull the bracket out the rear.

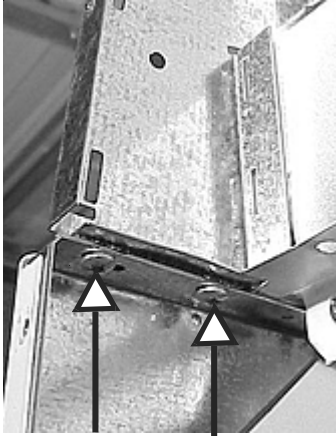

Two screws

Removing the control panel:

1. Disconnect power and remove the back panel of the backguard and top trim.
2. Remove the fluorescent light bulb and sockets, light switches and indicator lights.
3. Remove the screws holding the top element switches, the small oven thermostat to the control panel and drop the electronic oven control mounting plate down.
4. Remove the end caps, disconnect the ground wire and lift the control panel off.

Main top area

Removing coil elements and drip pans:

1. Raise the end of the element about an inch and pull the element out. The drip pan then lifts out.



Element and drip pan

Terminal block:

1. Disconnect power and remove the element and drip pan.
2. Remove the one screw holding the terminal block to the main top.

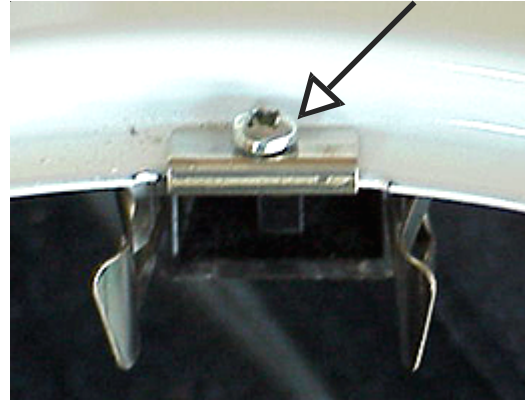

One screw

Note: When replacing the terminal block the replacement terminal block will have two short leads and ceramic wire nuts.

Removing the main top:

1. Disconnect power and remove the back panel of the backguard.
2. Remove the elements and drip pans, and disconnect the terminal block from the top.
3. Open the oven doors and remove the two screws holding the top to front oven trim.



Two screws

4. Remove two screws, one on each side, that hold the top to the hinges and lift the top off.

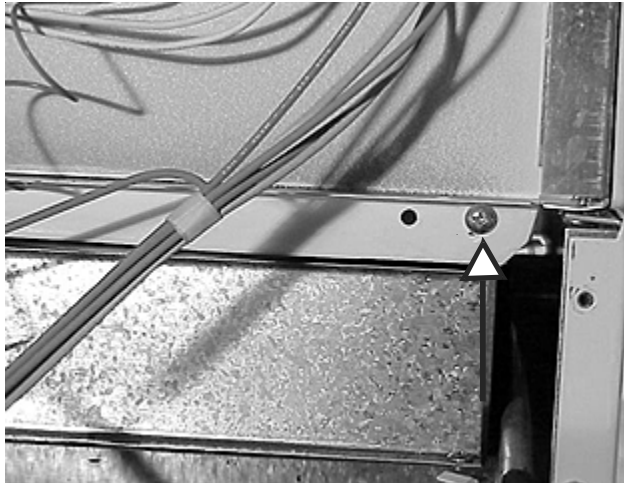

One screw in each hinge

Removing rear hinge:

1. Disconnect power and remove the back panel of the backguard.
2. Remove the two screws holding the front of the main top to the oven trim and the two screws holding the rear of the top to the hinges.
3. Move the top forward and remove the one screw holding the hinge to the corner brace.



One screw

Removing the lock rod:

1. Raise the front of the main top and remove the screw holding the rod to the spring and sleeve. Pull the rod out the front of the range.

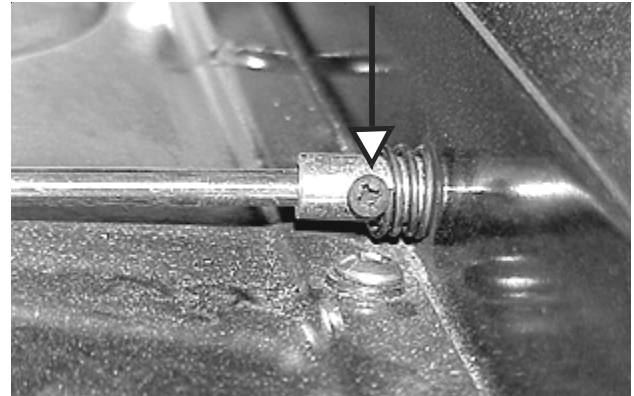

One screw

Removing the oven door latch plate:

1. Open the small oven door and remove the two screws holding the plate to the trim.

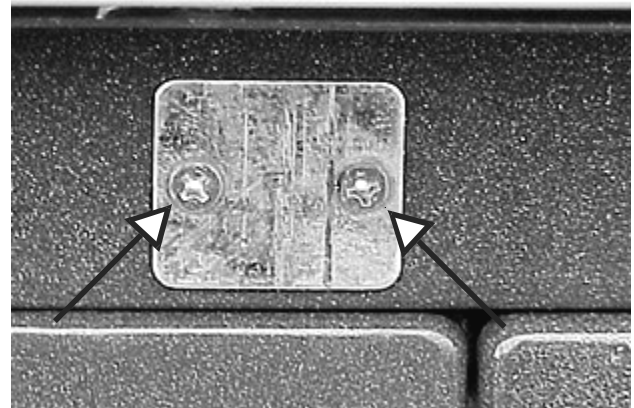

Two screws

Removing the small oven door hinges:

1. The hinges are held to the top oven trim and the front frame by two screws each. Remove the two screws holding the top hinge, lift the door off, and remove the two screws holding the bottom hinge.

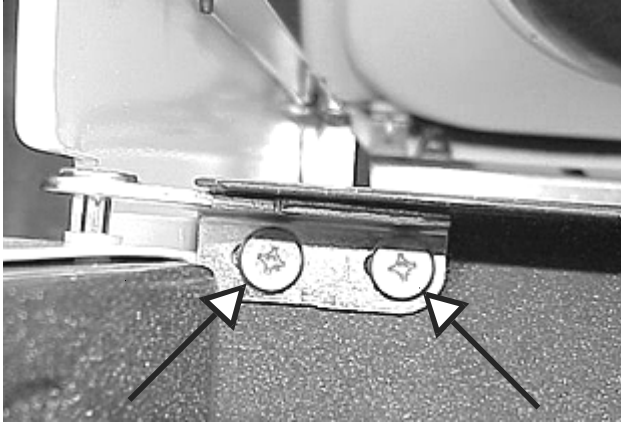

Two screws

Removing the large oven door seal: (self-clean models)

1. The oven door seal is held to the inner door liner by spring clips.

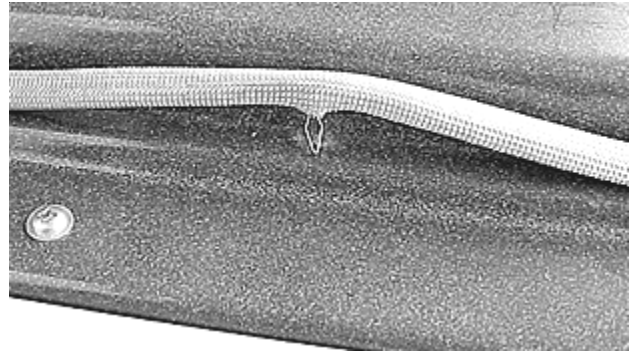

Clip

Removing the front oven trim:

1. Remove the latch rod, the small oven latch plate and the top hinge for the small oven.
2. Remove the four screws holding the top trim to the bodysides, two at each end, and seven screws holding the trim to oven frame.

2. To remove the seal place a flat blade screw driver between the seal and the liner beside the clip and lift the screw driver.

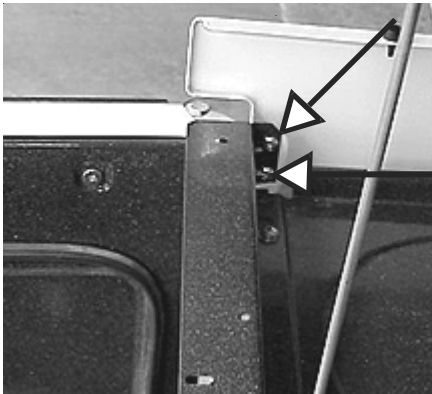

Two screws at each end

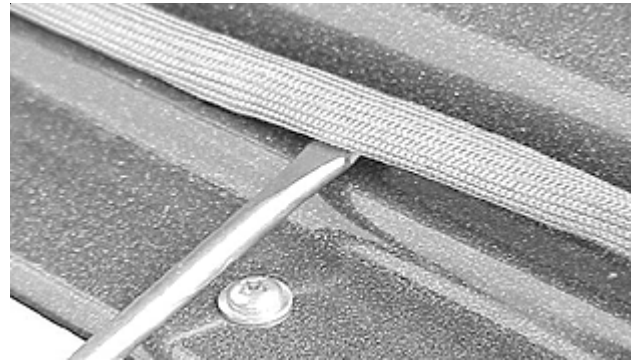

Screw driver

Note: Be careful not to scratch the liner.

Removing the large oven door:

1. Open the oven door completely and lock the hinges with the hinge lock.
2. Raise the top of the door and at the same time roll the bottom of the door and the hinges out of the front frame.

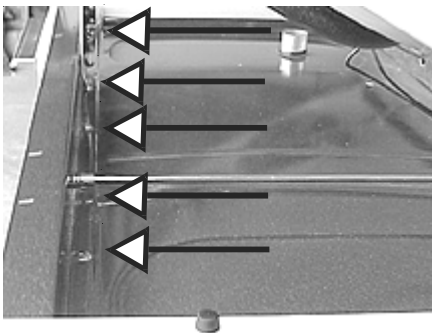

Seven screws

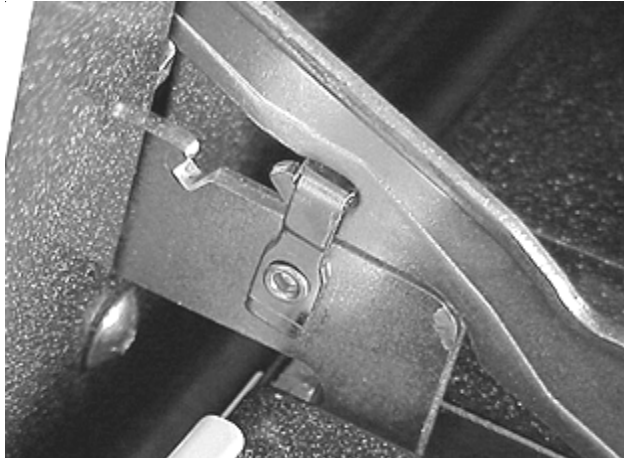

Hinge lock

Removing the large oven door's outer panel:

1. Remove the oven door and lay it on something soft so that the liner does not get scratched.
2. Remove the three screws from the top, three screws from the bottom and lift the panel off.



Three screws at the top

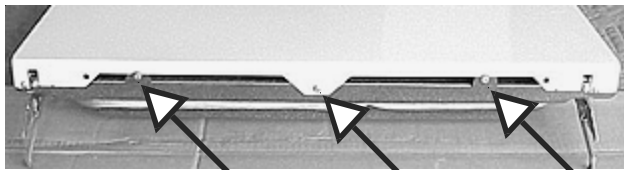

Three screws at the bottom

Removing the large oven door's outer panel glass seal:

1. Remove the outer door panel and lift the seal off of flange for the window opening.

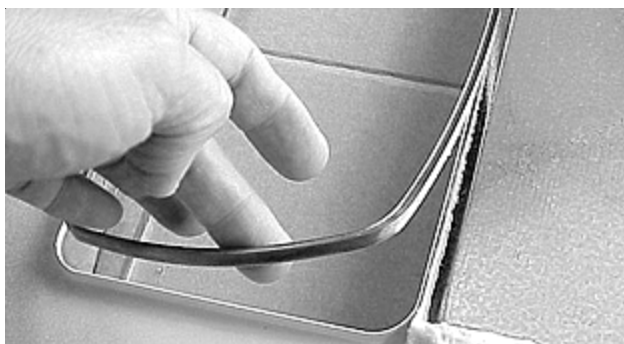

Panel glass seal

Removing the large door's small heat shield and door handle:

1. Remove the outer door panel and the two screws holding the shield and handle.

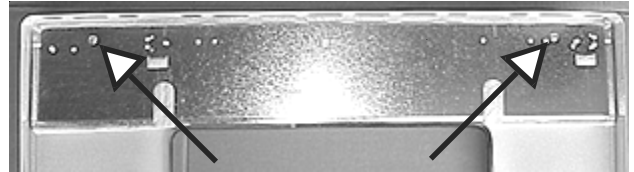

Two screws

Removing the large door's outer glass:

1. Remove the outer door panel and the outer door glass will lift off.

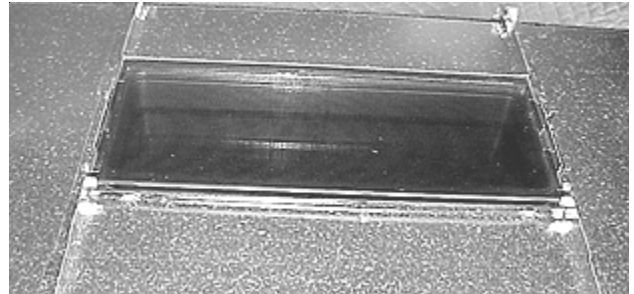

Lift the glass off

Removing the large door's heat barrier glass:

1. Remove the outer door panel and one of the heat shield rails by removing four screws. One at the bottom, two in the middle and one at the top.



One screw at the bottom

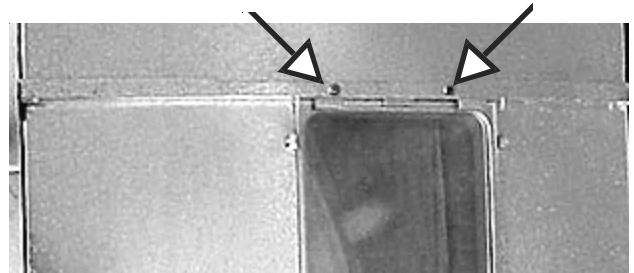

Two in the middle



One at the top

Removing the wool shield:

1. Remove the two rails and the remaining two screws that hold the wool shield to the spacer, then lift the wool shield off.

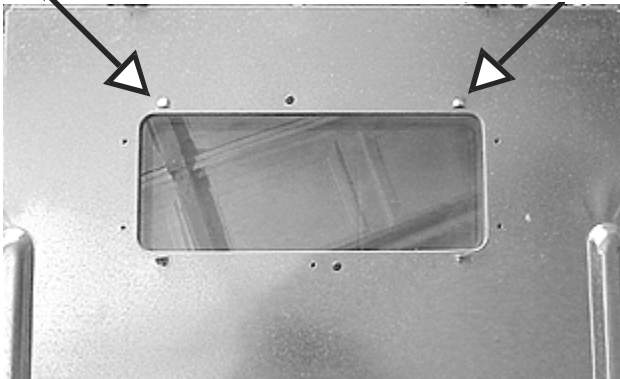

Two screws

Removing the door hinge:

1. Remove the heat shield, one screw at the bottom and one screw from the face of the inner door liner.

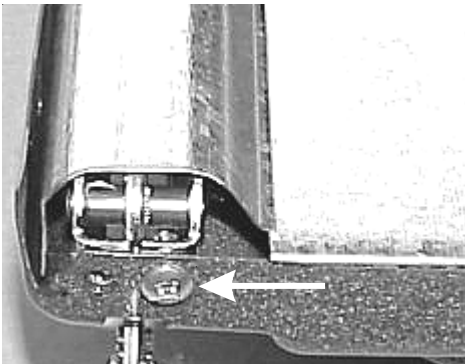

One screw at the bottom

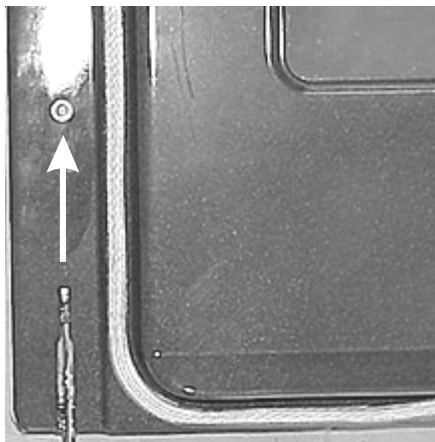

One screw

Removing the middle glass and wool spacer in the large oven door:

1. Remove the rails, wool shield, and insulation.
2. Remove the middle glass and wool spacer by removing the two brackets that hold the spacer to the inner liner.
3. To remove the lower bracket remove three screws holding it to the inner liner and to remove the upper bracket remove two screws holding it to the inner liner.

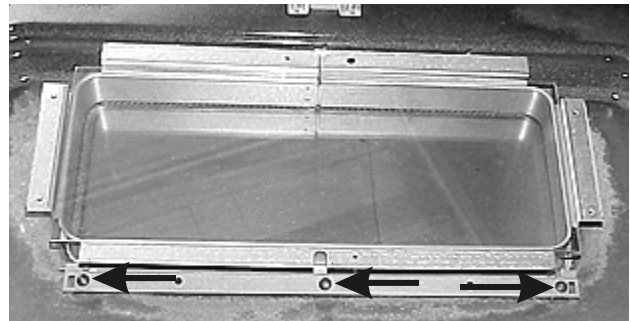

Lower bracket

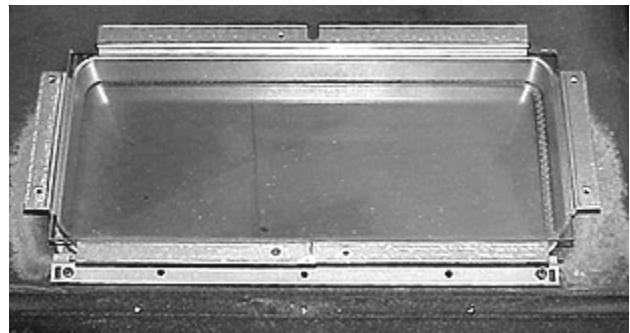

Removing the inner glass in the large oven door:

1. Remove the middle glass and wool spacer and lift the glass out.

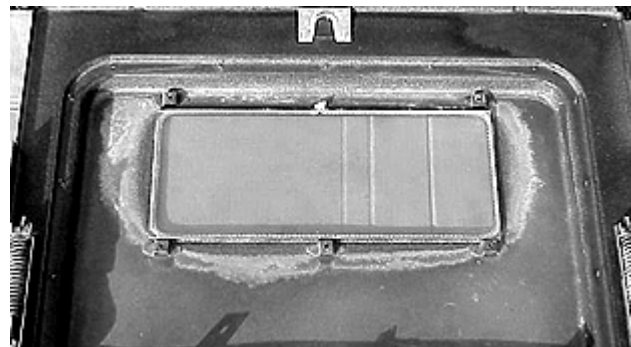

Inner glass

Removing the seal between the inner glass and the inner door liner in the large oven door:

1. Remove the inner door glass and the seal around the inner liner window flange.

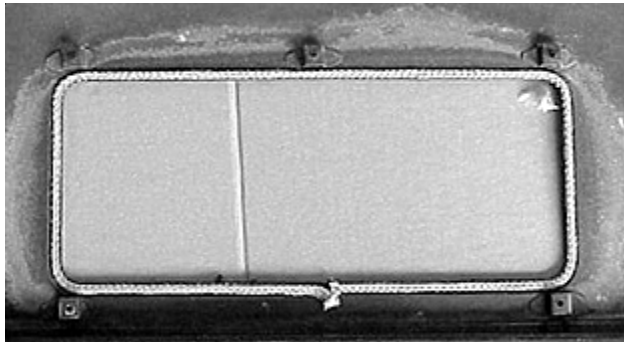

Rope seal

Small oven door

Removing the small door seal:

1. The door seal is held to inner door liner by spring clips. To remove the seal insert a flat bladed screw driver between the seal and the liner by the clip and lift up on the seal.



Spring clip

Removing the small door magnetic latch:

1. Remove the oven door and lay it on something soft so that the liner does not get scratched.
2. The latch is held to the inner door liner by two pop rivets. Drill the rivets out and the latch will lift out. Use pop rivets when replacing.

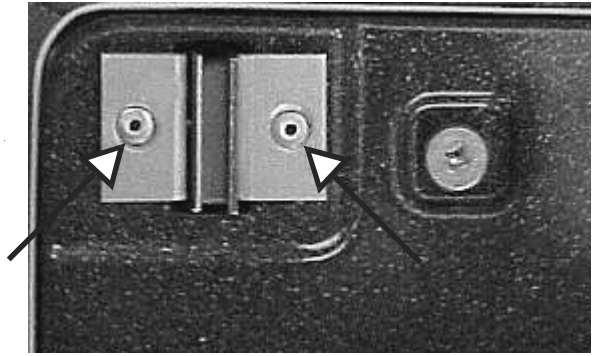

Two rivets

Removing the small oven door's outer panel:

1. Remove the oven door and lay it on something soft so that the liner does not get scratched.
2. Remove two screws at the top of the inner liner and two screws from the bottom of the door. The panel will then lift off.

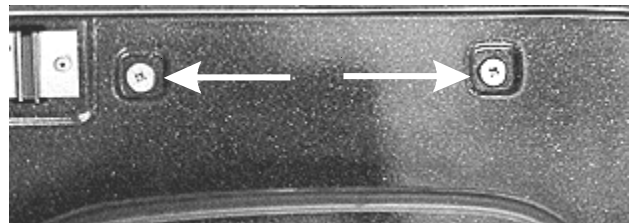

Two screws at the top

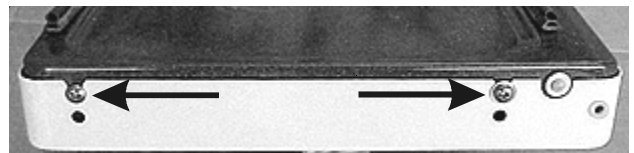

Two screws at the bottom

Removing the small door handle:

1. Remove the outer door panel and remove the two screws holding the handle and spacer to the panel.

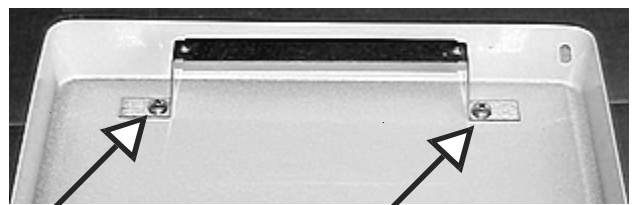

Two screws

Removing the small door's heat shield:

1. Remove the outer door panel and lift out the insulation.



Insulation

2. Remove the four screws, two on each side, holding the shield to the inner liner.

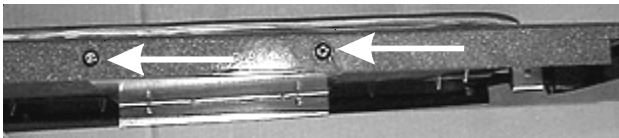

Two screws

Removing large oven bake element:

1. Disconnect power and remove the two screws that hold the element to the oven liner.
2. Pull the element into the oven and disconnect the wires.

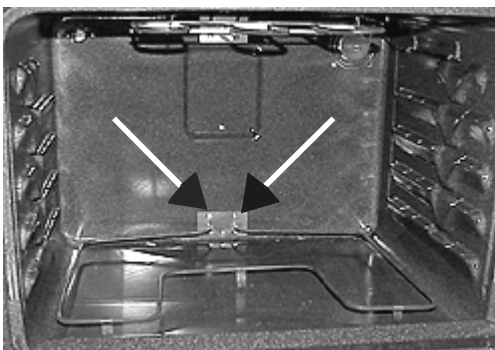

Two screws

Removing the broil element large oven:

1. Disconnect power and unplug the two wire hanger from the front of the element.



Two wire hanger

2. Remove the two screws holding broil element to the liner and pull the element into the oven.

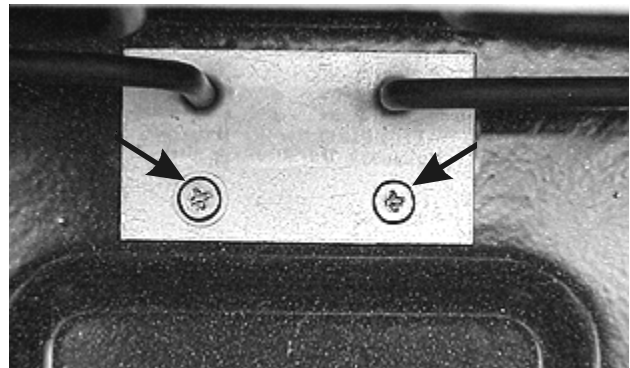

Two screws

Removing the oven sensor in the large oven:

1. Disconnect power, remove the shield from the rear of the range and unplug the sensor.

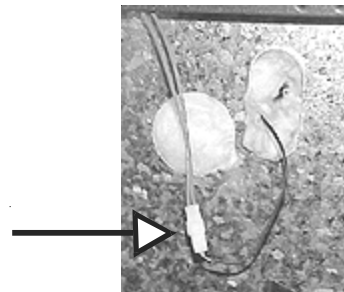

Disconnect the sensor

2. Remove the two screws holding the sensor to the rear wall and pull the sensor into the oven.

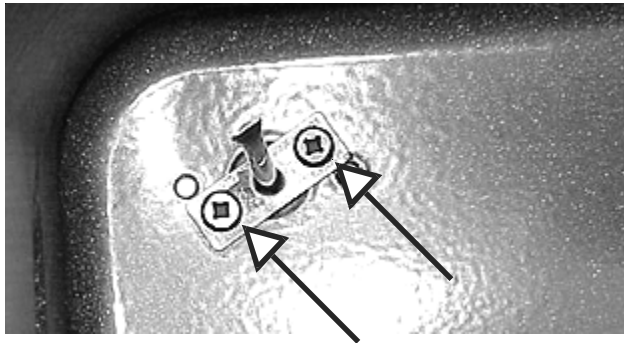

Two screws

Removing the large oven vent:

1. The base of the oven vent is tabbed and the top of the oven liner is notched. Turn the base of the vent until the tabs line up with the notches and pull the vent into the oven.



Oven vent

Removing the oven light shield in the large oven:

1. The oven light shield is held to the rear wall of the oven by a wire clip. Unsnap the wire clip and the shield can be lifted off.

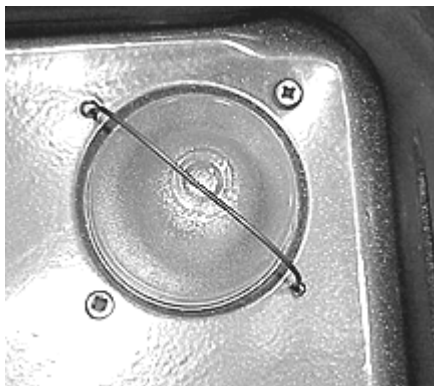

Wire clip

Removing the oven light socket in the large oven:

1. Disconnect power and remove the panel from the rear of the range.
2. From inside the oven remove the two screws holding the socket to the oven liner, pull the socket out the rear of the range and disconnect the wires.

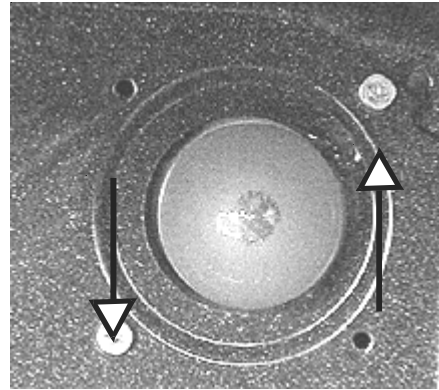

Two screws

Removing the small oven bake element:

1. Disconnect power and remove the front element shield by removing two screws.

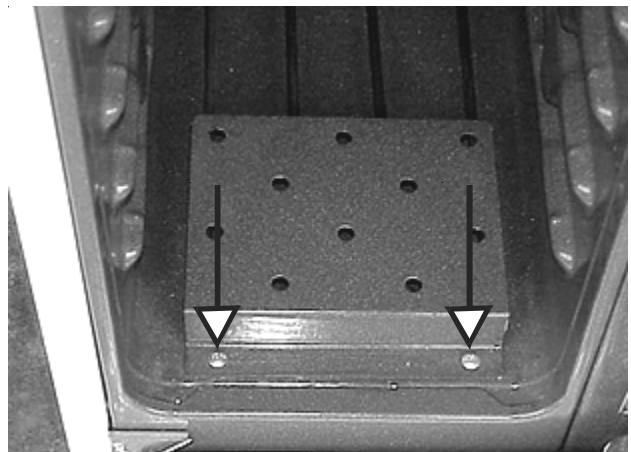

Two screws

2. Remove the two screws holding the element to the rear wall. Pull the element into the oven and disconnect the wires.

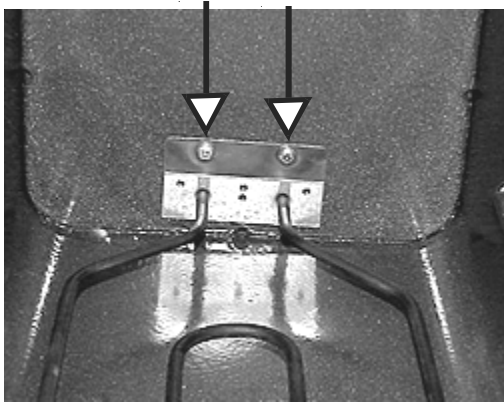

Two screws

Removing the small oven broil element:

1. Disconnect power and remove the two screws holding the element to the wall of the oven and slide the element forward to disengage the tab in the front.

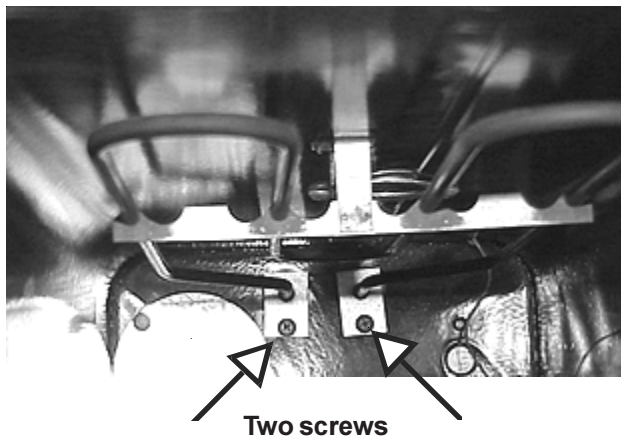

Two screws

Removing the small oven's oven vent:

1. Disconnect power and drop the broil element. Remove the two screws holding the vent to the top of the oven and pull the vent down.

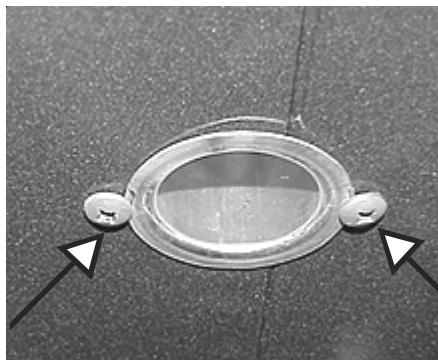

Two screws

Removing the storage drawer handle:

1. Slide the storage drawer open and remove the three screws holding the handle to the storage drawer panel.

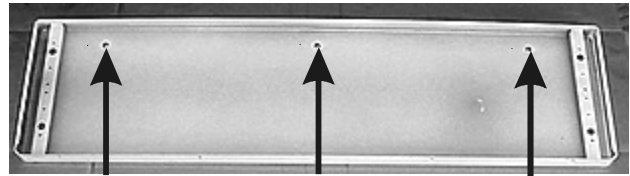

Three screws

Removing the storage drawer bottom sweep:

1. Pull the storage drawer out and remove the three screws that hold the bottom sweep, the front panel and the drawer body.

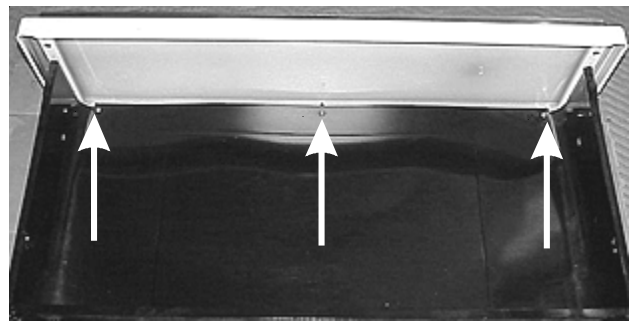

Three screws

Removing the storage drawer panel:

1. Pull the drawer out and remove the bottom sweep.
2. Remove the four screws, two on each side, that hold the panel to the drawer.

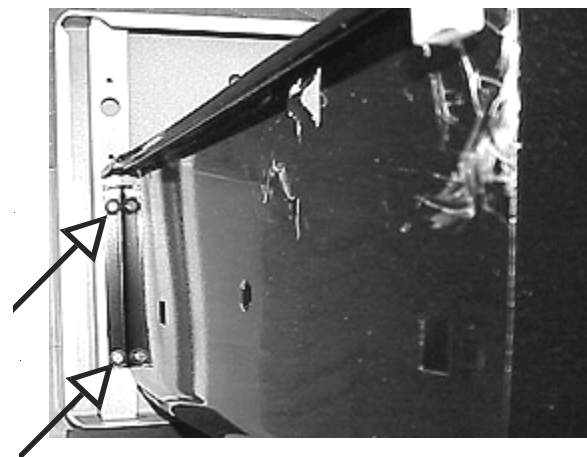

Two screws on each side

Removing the drawer glide:

1. Each drawer glide is held to the drawer by one screw. Remove the screw and lift the glide off.

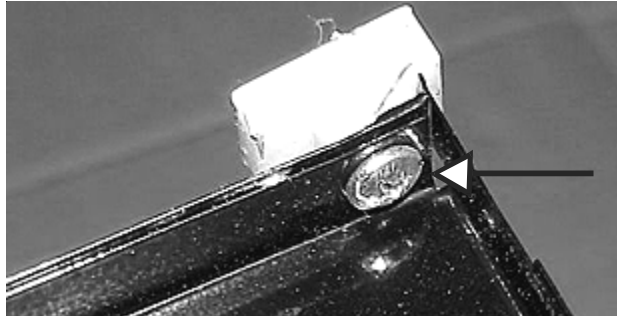

One screw

Removing the drawer glide and rail on the chassis:

1. Remove the one screw holding the glide and rail in the front and pull the rail forward.

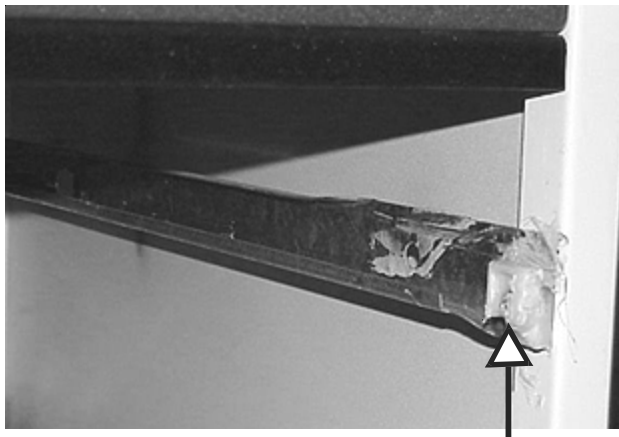

One screw

Removing the large rear panel:

1. Disconnect power and remove the four screws holding the panel to the rear of the range.

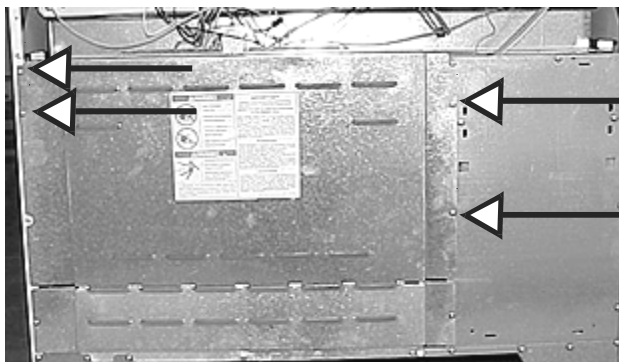

Four screws

Removing the lock motor assembly:

1. Disconnect power and remove the panel covering the rear of the backguard and rear panel.
2. Mark and disconnect the wires from the lock motor assembly.
3. Remove the two screws holding the lock motor assembly to the rear of the range, then slide the assembly back to release it from the lock rod.

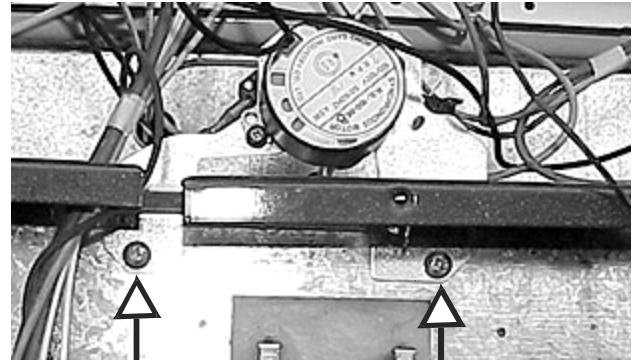

Two screws

Removing small rear panel:

1. Disconnect power and remove the fifteen screws holding the panel to the rear of the range.

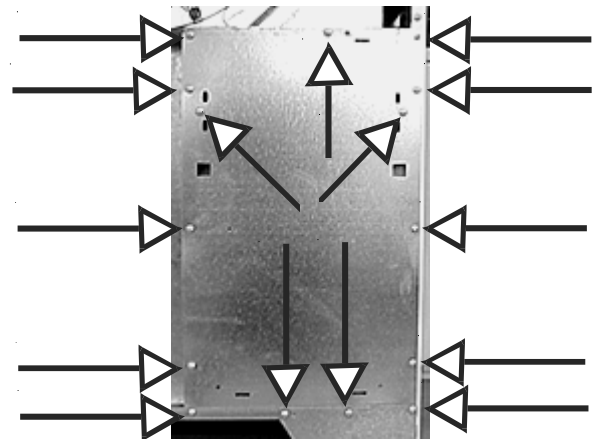

Fifteen screws

Removing the thermal circuit breaker:

1. Disconnect power and remove the small rear panel and disconnect the wires from the circuit breaker.

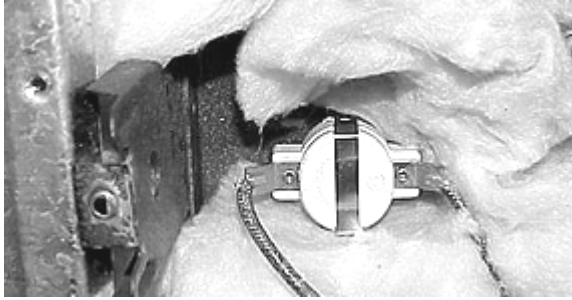

Disconnect wiring

- From inside the small oven remove the two screws holding the circuit breaker to the rear wall and slide the circuit breaker out the back of the range.

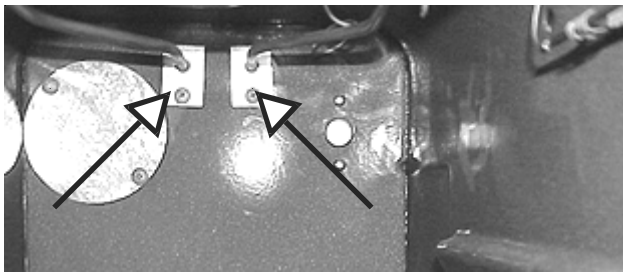

Two screws

Removing the righthand bodyside:

- Disconnect power remove the large oven door and storage drawer.
- Remove the rear panel from backguard and the large rear panel. Remove the remaining seven screws holding the back flange of the bodyside to the range.

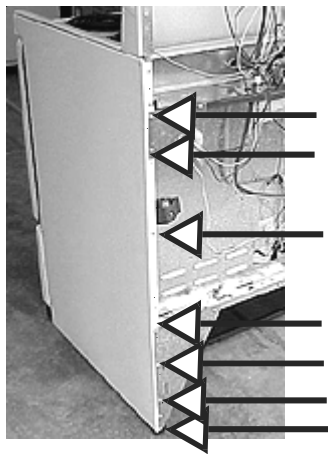

Seven screws

- Remove the one screw holding the bottom rear brace to the bottom inside flange of the bodyside.

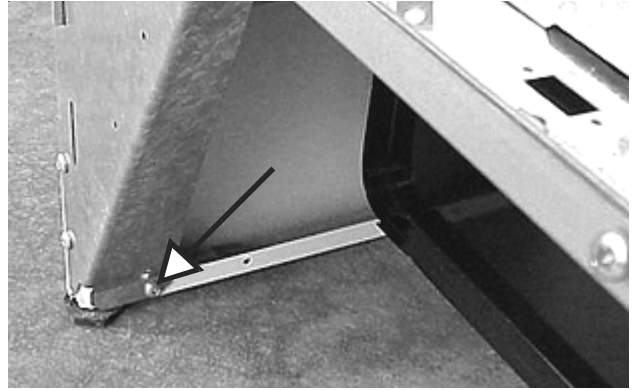

One screw

- Remove the two screws holding the top to the hinges and lift top up and forward. Remove the one screw holding the hinge to the bodyside.



One screw

- Raise the main top and remove the two screws from the front corner holding the bodyside to the front frame.

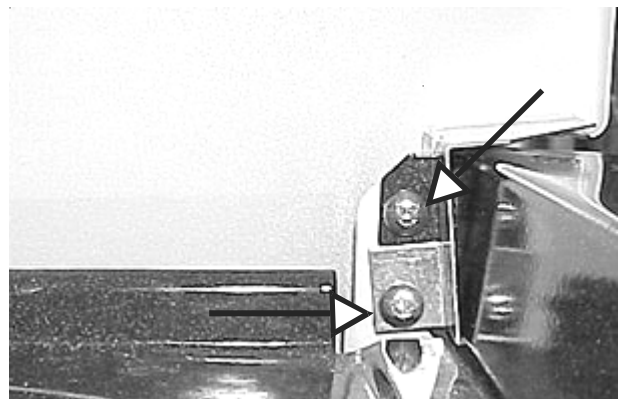

Two screws

- Remove the storage drawer glide by removing one screw and sliding the glide forward.

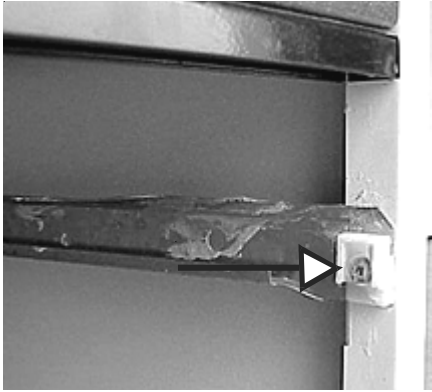

One screw

- Place a block between the upper and lower brace to hold the range.

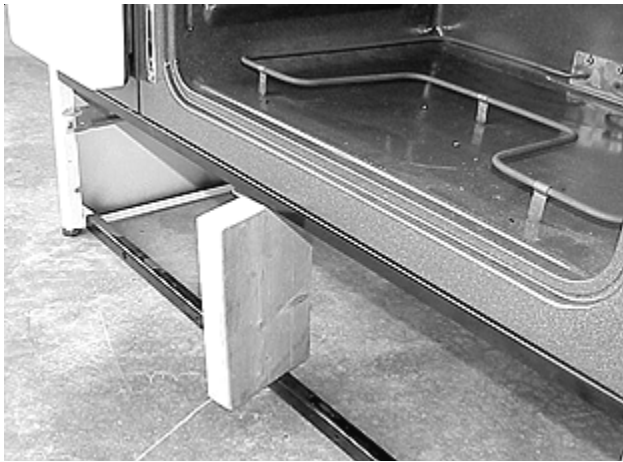

Block

- Remove one screw holding the upper brace to the side panel.



One screw

- Remove one screw holding the lower brace to the side panel and lift the panel off.



One screw

Removing the side heat shield:

- Remove the bodyside and remove the two screws holding the side shield to the bottom shield. Flex the center of the shield out and pull back on the shield .

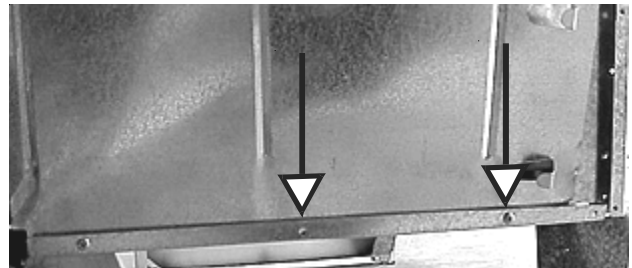

Two screws

Removing door switch:

- Disconnect power, remove the righthand bodyside and heat shield.
- Unplug the wires from the switch and squeeze the tabs on the side of the switch and push it out the front.

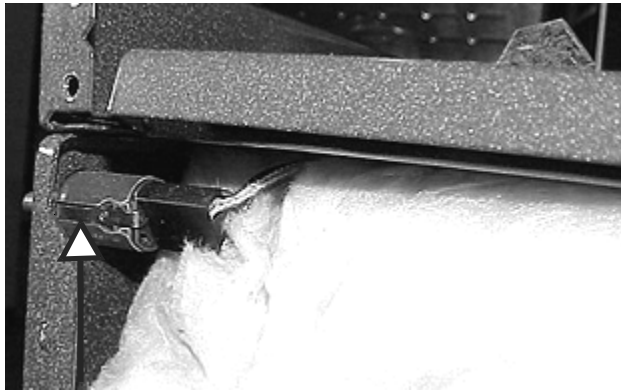

Tabs

Removing the large door righthand hinge roller bracket:

1. Disconnect power, remove the righthand bodyside and heat shield.
2. Remove the two screws holding the bracket to the front frame and slide the roller bracket out the back.

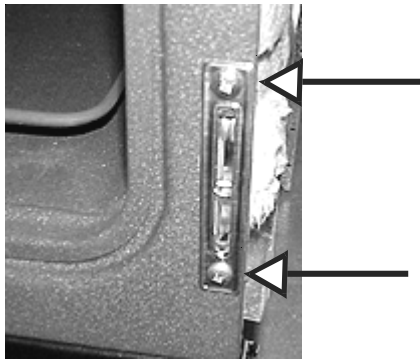

Two screws



Roller bracket

Removing the large door lefthand hinge roller bracket:

1. Remove the two screws holding the bracket to the front frame and slide the roller bracket down.



Two screws

2. Raise the corner of the small bottom heat shield and pull the roller bracket down between the small shield and the large shield.



Push up

