

**U.S.A.  
ELECTRONIC FRONT LOADER WASHER  
AND  
COMBINATION WASHER/DRYER**

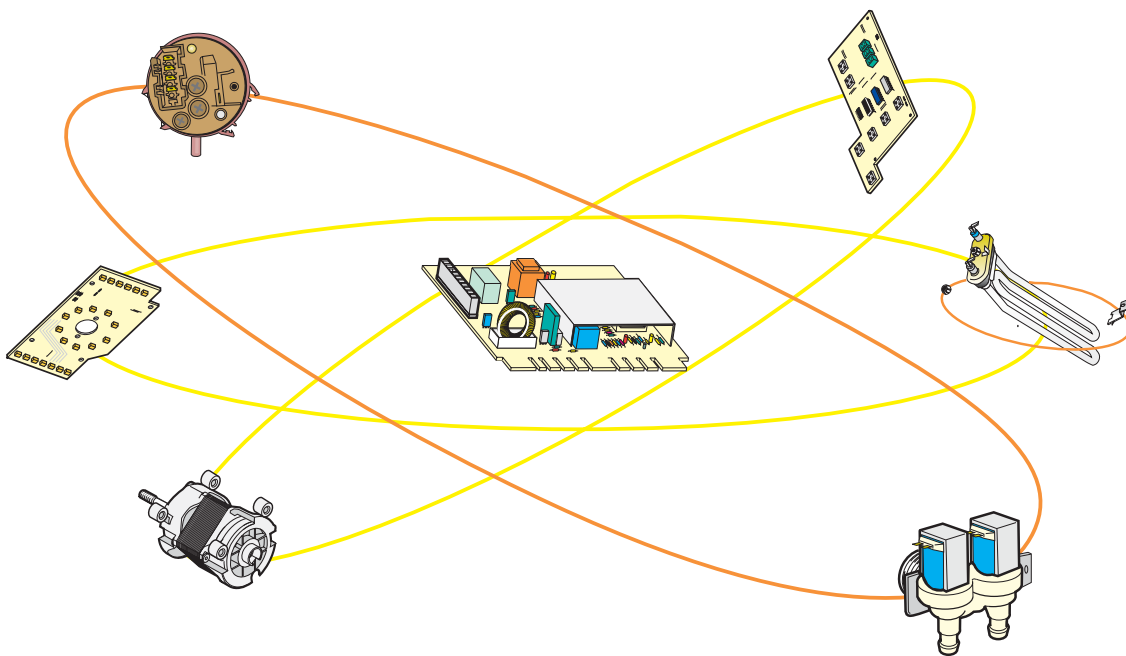

**WASHING MACHINE MODELS:** *ASKO WAM1712W*      code 010477003  
*Eurotech EWF272EL*      code 010477006  
*Eurotech EWF272ELGH*      code 010477007

**WASHER DRYER MODELS:**      *Eurotech EWC177W*      code 014477001  
   *ASKO WCAM1812*      code 014477002

# SAFE SERVICING PRACTICES

To avoid the possibility of personal injury and/or property damage, it is important that safe servicing practices be observed. The following are examples, but without limitation, of such practices:

1. Do not attempt a product repair if you have any doubts as to your ability to complete it in a safe and satisfactory manner.
2. Before servicing or moving an appliance:
  - . remove power cord from electric outlet, trip circuit breaker to OFF, or remove fuse.
  - . turn off water supply.
3. Never interfere with the proper operation of any safety device.
4. **USE ONLY REPLACEMENT PARTS CATALOGED FOR THIS APPLIANCE. SUBSTITUTIONS MAY DEFEAT COMPLIANCE WITH SAFETY STANDARDS SET FOR HOME APPLIANCES.**
5. **GROUNDING:** The standard color coding for safety ground wires is GREEN or GREEN with YELLOW STRIPES. Ground leads are not to be used as current carrying conductors. **IT IS EXTREMELY IMPORTANT THAT THE SERVICE TECHNICIAN RE-ESTABLISH ALL SAFETY GROUNDS PRIOR TO COMPLETION OF SERVICE. FAILURE TO DO SO WOULD CREATE A POTENTIAL HAZARD.**
6. Prior to returning the product to service ensure that:
  - . all electric and water connections are correctly and securely connected.
  - . all water connections are tested for leaks.
  - . all electrical leads are properly dressed and secured away from sharp edges, high-temperature components and moving parts.
  - . all uninsulated electrical terminals, connectors, heaters, etc. have adequate spacing from all metal parts and panels.
  - . All safety grounds (both internal and external to the product) are correctly and securely connected.
  - . all panels are properly and securely reassembled.

**CAUTION:** When servicing a water using appliance in a location where the water supply has not been in use for an extended time (such as vacation), open the hot water faucet at the sink and allow the water to run for several minutes allowing water and accumulated hydrogen gas to escape. Make sure there are no open flames (pilots) or cigarettes near the faucet.

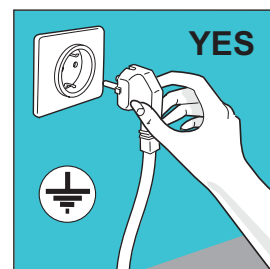
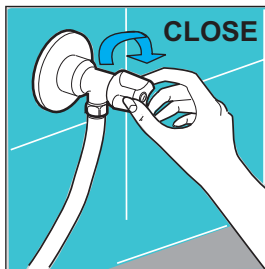
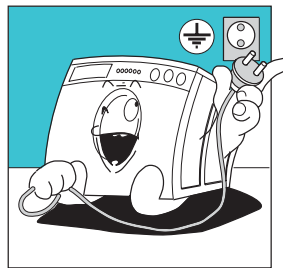
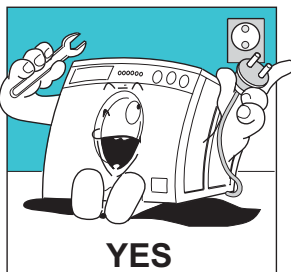

# IMPORTANT

This Service Manual must be used together with all the other technical documents appertaining to the product itself (Exploded views, wiring diagrams and any other technical information provided).

**Remove the plug from the mains power supply when carrying out any operations on the machine.**

## RATING PLATE

The rating plate is located on the cabinet inside the main door on the front of the washing machine. If the cabinet needs to be replaced, remove the rating plate from the cabinet itself and attach it to the new one.

The rating plate reports all the nominal data required by current standards (power supply voltage, total absorbed power, etc...).

The serial number consists of 11 characters that indicate the date of manufacture and serial number:

For example:

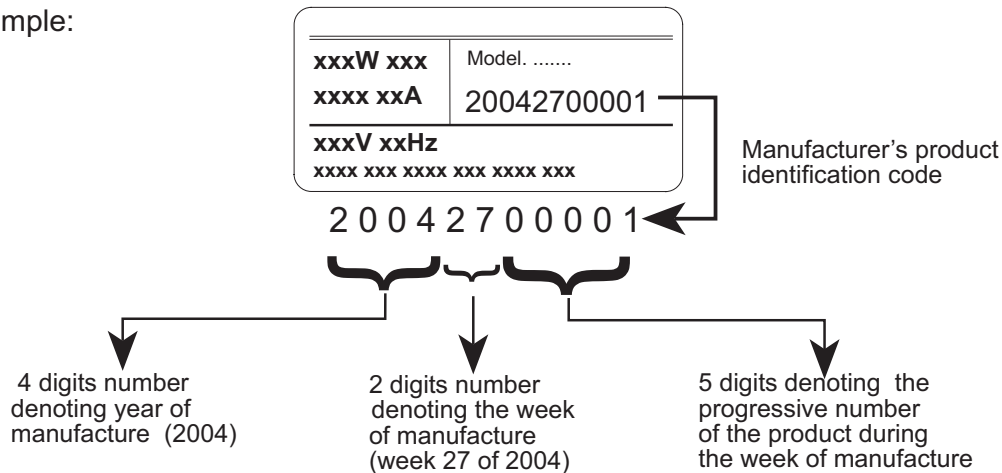

Should any problems occur with a washing machine, the Main Technical Assistance Office in your country must be informed of the serial number and the model in question in order to help the manufacturer identify the product.

## DESCRIPTION OF THE MACHINE

- 1 - Door filter
- 2 - Lint filter
- 3 - Adjustable leveling feet
- 4 - Drum
- 5 - Door handle
- 6 - Door
- 7 - Rating plate
- 8 - Scratch-resistant top

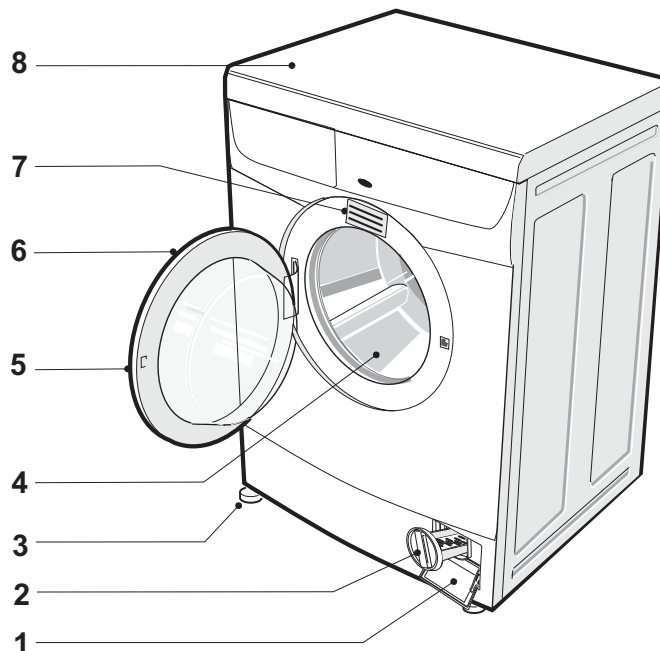

ELECTRONIC CONTROL PANEL DESCRIPTIONS

- 1 - Detergent drawer.
- 2 - "Start" button
- 3 - "Prewash" button
- 4 - "Extra Rinse" button
- 5 - Wash program control knob.
- 6 - "On/Off" button.
- 7 - Cycle Indicator Lights
- 8 - Drying time control knob
- 9 - Spin speed control knob

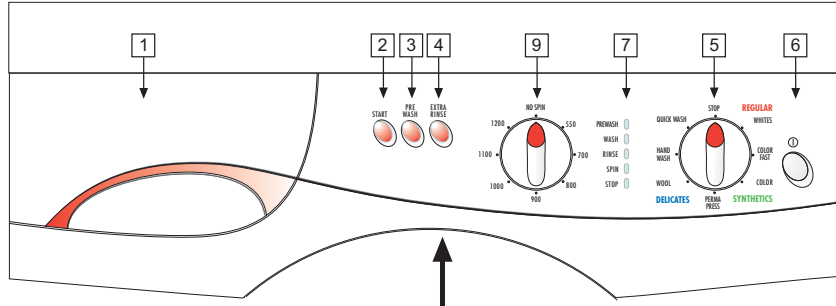

WASHING MACHINE **ASKO WAM1712W** code 010477003

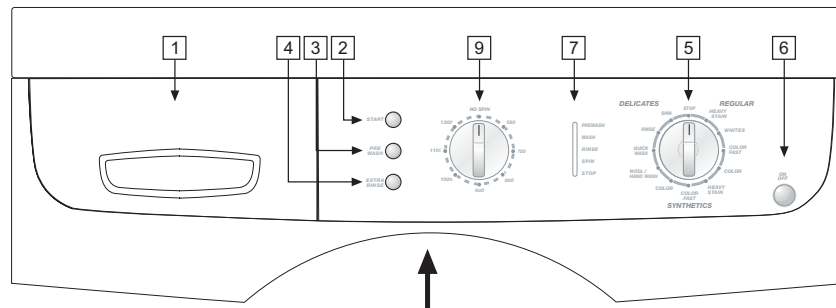

WASHING MACHINE **Eurotech EWF272EL** code 010477006  
**Eurotech EWF272ELGH** code 010477007

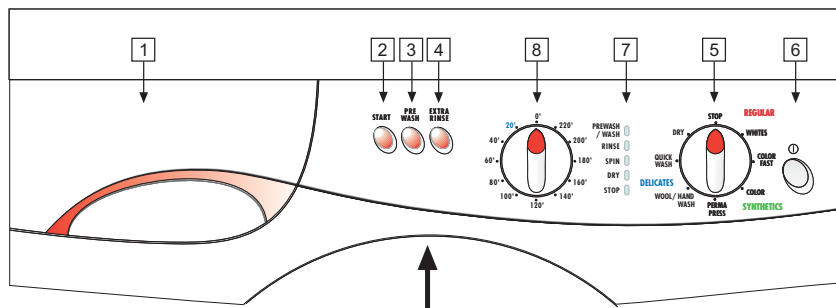

WASHER DRYER **ASKO WCAM1812** code 014477002

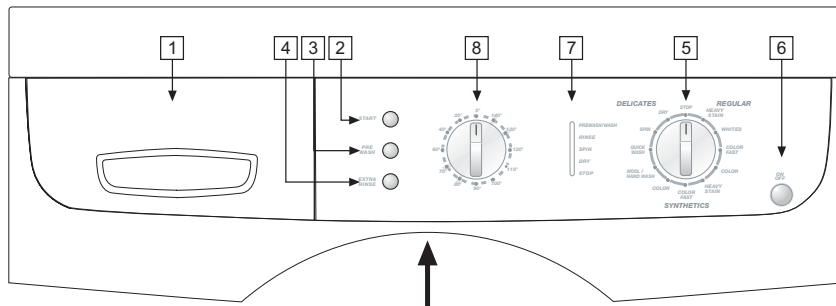

WASHER DRYER **Eurotech EWC177W** code 014477001

## TECHNICAL DATAS

### ELECTRICAL CONNECTION

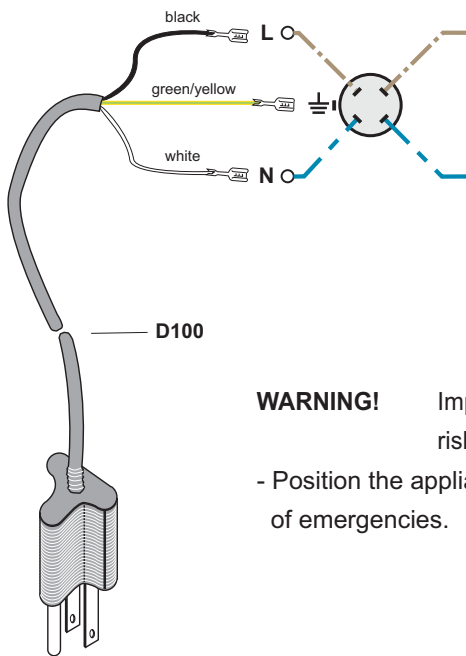

Check to make sure the main power supply and the outlet are appropriate to support a 110/120 V, 15 amp single-phase circuit.

The power supply voltage is indicated on the rating plate inside the main door of the washing machine.

#### Grounding Instructions

This appliance must be grounded. In the case of malfunction or breakdown, grounding will reduce the risk of electric shock by providing a path of least resistance for electric current. This appliance is equipped with a cord having an equipment-grounding conductor and a grounding plug.

The plug must be plugged into an appropriate outlet that is properly installed and grounded in accordance with all local codes and ordinances.

**WARNING!** Improper connection of the equipment-grounding conductor can result in a risk of electric shock. Do not modify the plug provided with the appliance.

- Position the appliance so that the plug can be accessed and disconnected easily in case of emergencies.

### WATER SUPPLY

This washing machine can only be connected to the cold water supply system.

The water pressure must be between **.05 MPa minimum** and **1 MPa maximum**.

### WATER SUPPLY CONNECTION

Before making the water supply connection, allow a quantity of water to flow from the top.

The water should be clean and free from impurities, especially where the system is new or has been left unused for a length of time.

There are two hoses provided with the machine.

The hot water hose is indicated with a red strip running the length of the hose.

Insert the filter/washer supplied (Fig. 5) before connecting the water inlet hose to the valve.

Check that the other end of the hose is tight (Fig. 5A). Turn the supply valve on (Fig. 5B).

The drain outlet should be positioned at a height of between 23" (60 cm) and 35" (90 cm) above the floor (Fig. 6).

**NOTE:** To prevent siphoning, do not seal the drain hose connection into the drain outlet.

If the machine is not connected to a drain outlet, place the drain hose and bracket supplied over the edge of a sink or wash basin and anchor it in place.

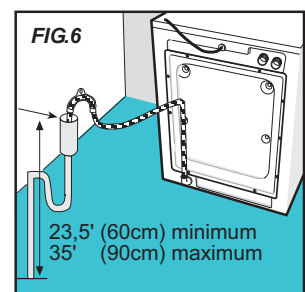
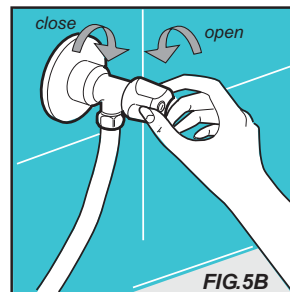
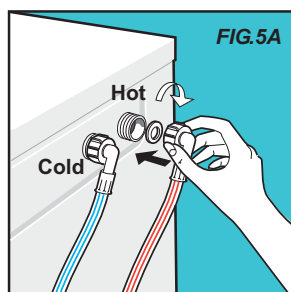
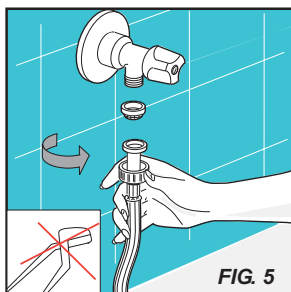

# EXAMPLE OF ELETTRICAL DIAGRAM - COMBINATION WASHER/DRYER

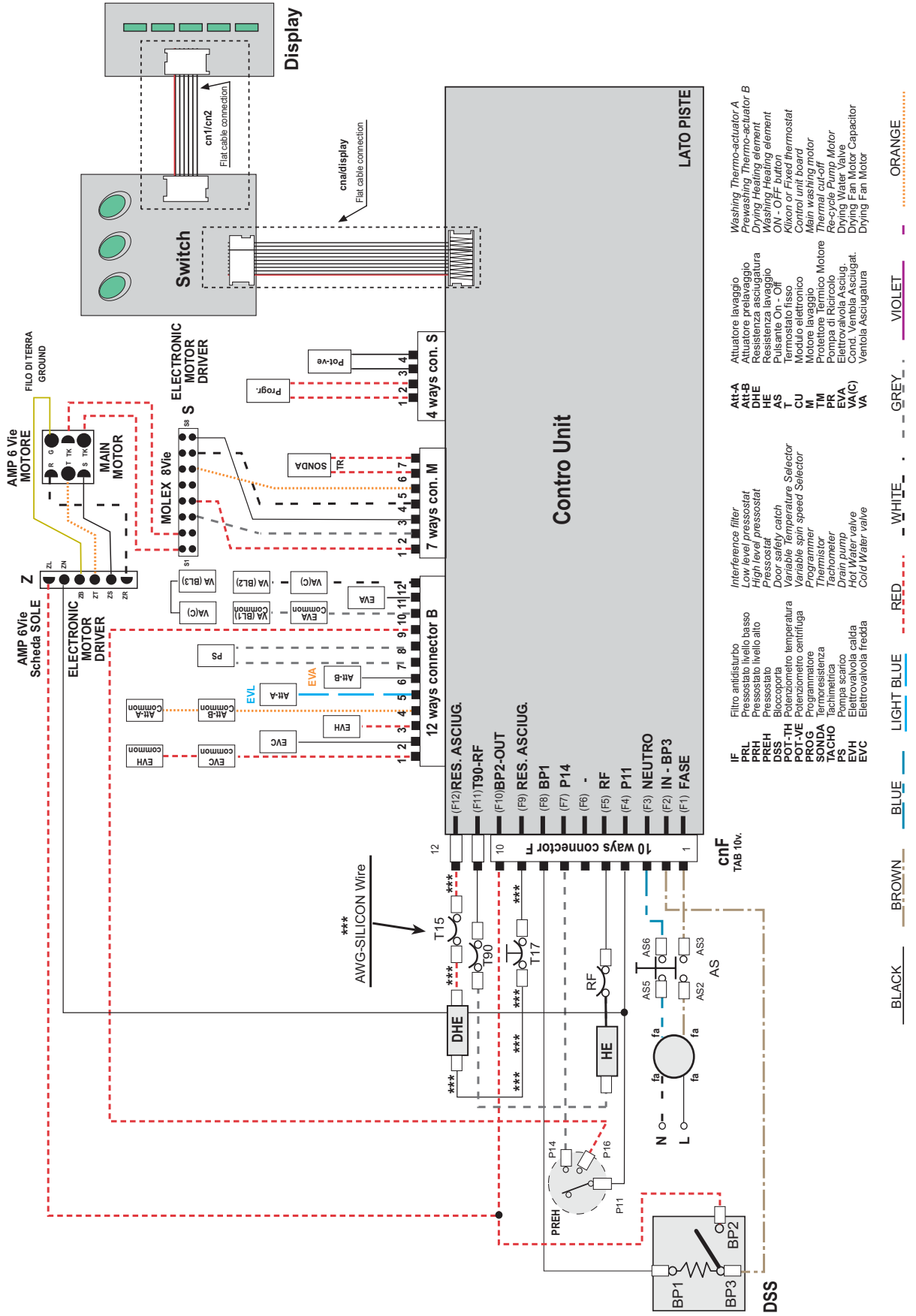

# EXAMPLE OF ELECTRICAL DIAGRAM - WASHING MACHINE

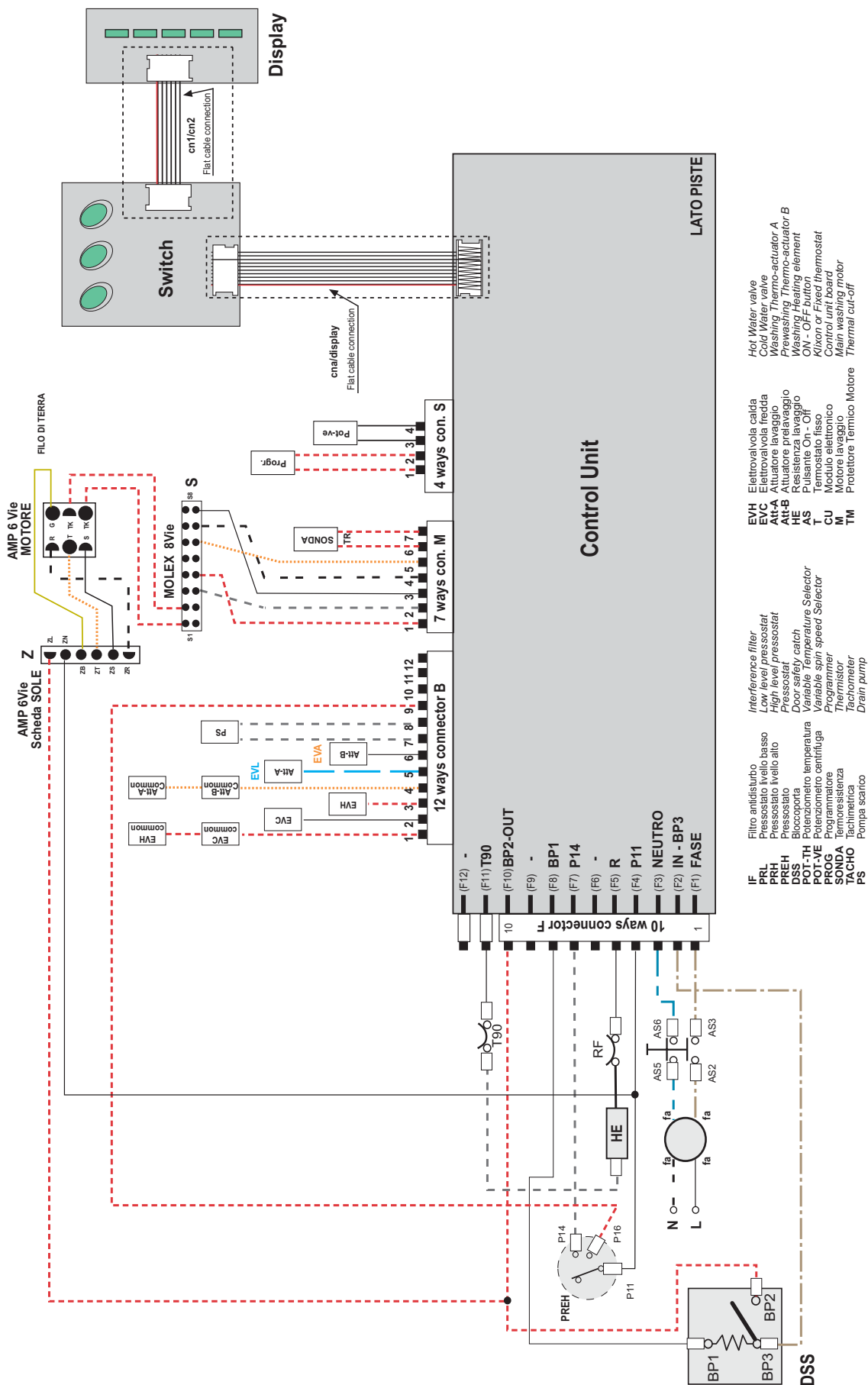

## TECHNICAL DATAS

1. **WASHER MODELS:**  
**ASKO WAM1712W** code 010477003 - 11 programs with various other combinations  
**Eurotech EWF272EL** code 010477006  
**Eurotech EWF272ELGH** code 010477007
- COMBINATION WASHER DRYER MODELS:**  
**Eurotech EWC177W** code 014477001 - 11 washing programs and 2 drying programs.  
**ASKO WCAM1812** code 014477002
2. **Dimensions**
- |                    |             |            |
|--------------------|-------------|------------|
| Height             | 33 - 1 / 4" | = 84.45 cm |
| Width              | 23 - 3 / 8" | = 59.37 cm |
| Depth              | 23 - 1 / 8" | = 58.74 cm |
| Depth w/door open: | 38 - 3/4"   | = 98.43 cm |
3. **General specifications**
- |                    |                       |
|--------------------|-----------------------|
| Voltage/ Frequency | 110/120 Volts - 60 Hz |
| Fuse               | 15 Ampères            |
4. **Drum volume** 65 liters
5. **Drum speed**
- |                 |                        |
|-----------------|------------------------|
| Slow spin       | 550 rpm.               |
| High speed spin | according to the model |
6. **Load capacity**
- |                    |                         |
|--------------------|-------------------------|
| Washing COTTONS    | max. 7,0 kg dry laundry |
| Washing SYNTHETICS | max. 3,5 kg dry laundry |
| Washing WOOL       | max. 1,5 kg dry laundry |
| Drying COTTONS     | max. 5,0 kg dry laundry |
| Drying SYNTHETICS  | max. 3,0 kg dry laundry |

### 7. Description of electrical components

#### 7.1 Tubular wash heating element with internal fuse



#### 7.2 Tubular dry heating element (only for combination washer/dryer)



#### 7.3 Synchronous drain pump

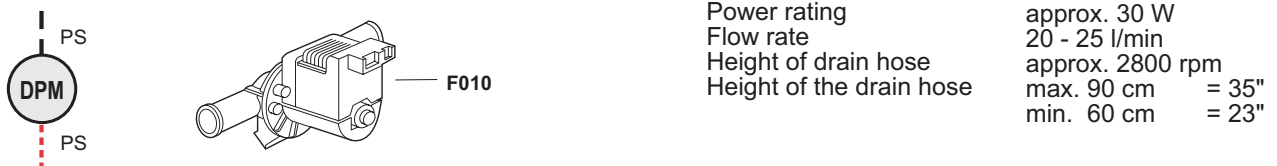

#### 7.4 Safety door catch

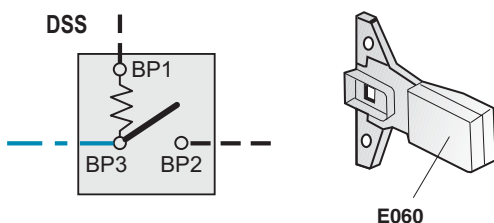

When a washing or drying cycle is in progress, a safety device prevents the door from being opened. To open the door while a wash program is running, switch off the washing machine using the On/Off button. The door can then be opened after a time lapse of approximately 2 minutes.

**NEVER OPEN THE DOOR IF THE WATER LEVEL IS VISIBLE THROUGH THE DOOR GLASS.**

**At the end of the cycle, wait for the END indicator light to flash before opening the door.**



## TECHNICAL DATAS

- 7.5 **Drying motor capacitor (H019)** (only for combination washer/dryer) 4  $\mu$ F 450Volts

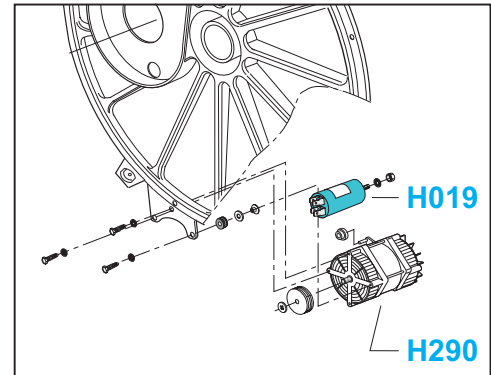
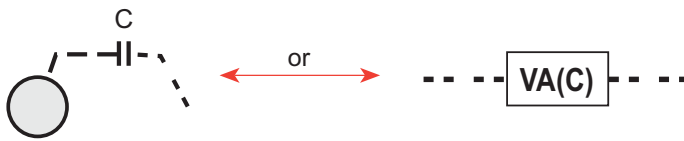

- 7.6 **Drying motor (H290)** (only for combination Washer/Dryer)
- |                                  |                  |
|----------------------------------|------------------|
| Type                             | 2 poles          |
| Isolation                        | Class F          |
| Max. absorbed power              | approx. 140 W    |
| Voltage (according to the model) | 120V - 60 Hz     |
| Anticlockwise speed Rotation     | approx. 2800 rpm |

### 7.7 Fixed thermostats

- A - **For washer and Combination washer/dryer:**  
Automatic reset 90°C fixed safety thermostat.  
Normally Closed for a wash.

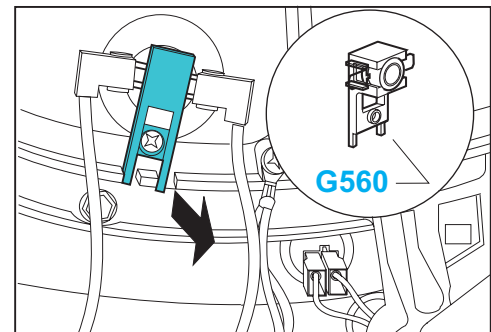

- B - **For washer and Combination washer/dryer:**  
Thermistor (temperature sensor for water in the tub)

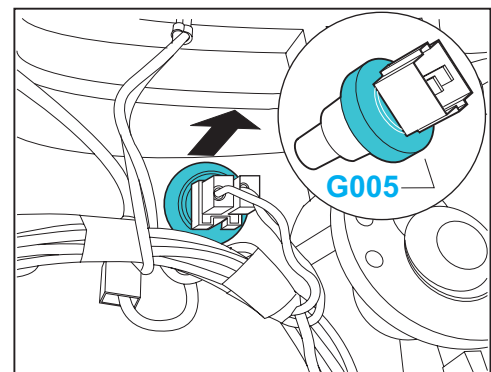
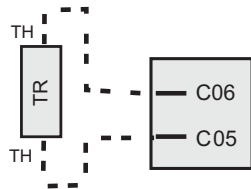

The thermistor checks the temperature of the water in the tub, to read between 0°C and 90°C (32°F and 194°F) with a tolerance of + / - 2°C (5°F). As soon as the water's temperature increases, the resistance in the thermistor decrease.  
The heating element will not work if the thermistor is in short-circuit or disconnected from the electronic circuit board.

Some thermistor values :

Water Temperature F° (C°)	68° (20°)	86° (30°)	104° (40°)	122° (50°)	140° (60°)
Resistance in kOhm	6,06	4,12	2,81	1,99	1,42

- C - **(only for combination washer/dryer)**  
T150°C long bulb fixed thermostat with automatic reset  
Normally Closed Contact, controls the drying temperature.

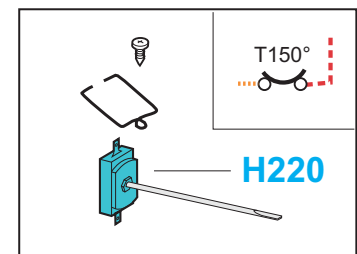

# TECHNICAL DATAS

D - **(only for combination washer/dryer)**  
 Half inch fixed safety thermostat with manual reset.  
 Normally Closed Contact.  
 Intervenes only if there is a fault in the 150°C drying thermostat or in the fan and drying unit.

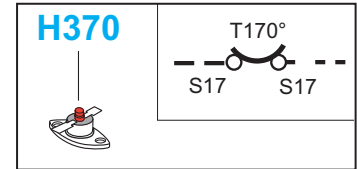

## 8.0 Pressure switch

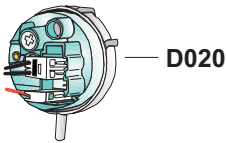

The single level pressure switch is used with the following functions:

### P11-P14

- Signals the electronic control unit (open/closed) that the low water level has been reached.
- Heater element safety switch.

The pressure switch has only 1 level that is identified in the legend with the letters (BL).

The contact P16 is the safety overflow that intervenes when too much water enters tub interrupting the power supply to the inlet valve and putting the drain pump in operation of draining the water.

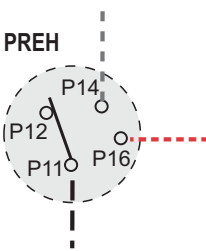

### Washing machine fill levels.

The electronic control unit calculates the washing machine fill levels according to the type and quantity of washing placed in the tub and the set program, and then adds a safety margin which is pre-programmed in the control unit software.

### FILLING PROCESS

Note: The below is only an example of the filling process

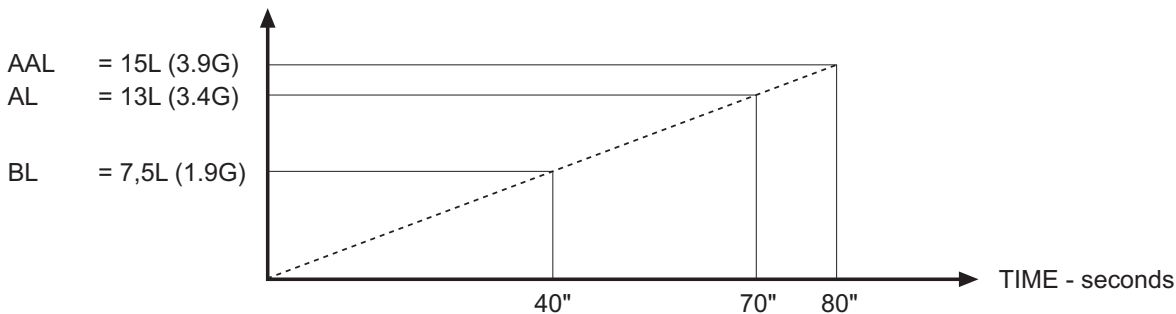

- BL (7,5litri) = 40" = Time to reach the first level ( by pressure switch )
- AL (13litri) = 40"+30" - with Maximum safety time 45" = P + 3/4 of the necessary time to reach BL
- AAL (15litri) = 40"+40" - with Maximum safety time 60" = P x 2 of the necessary time to reach BL

In the microprocessor of the electronic module, there is a safety check for the maximum time of the water filling. Should the first water level of the machine requires too much time due to very low pressure and the water pressure suddenly increase the water amount in an overfilled way, the AAL safety will intervene.

**NB: Every time the machine fills with water, the time to reach the first level is checked. To have the correct different levels, the BL must be reached within 60 seconds.**

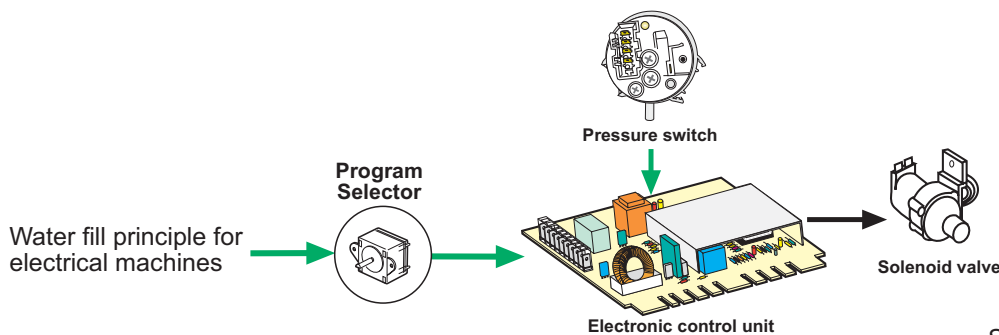

## TECHNICAL DATAS

### 9.0 Main power supply switch:

Washer ASKO WAM1712W  
 Washer Eurotech EWF272EL  
 Washer Eurotech EWF272ELGH  
 Combination Washer/Dryer EUROTECH EWC177W  
 Combination Washer/Dryer ASKO WCAM1812

Ref. 010477003  
 Ref. 010477006  
 Ref. 010477007  
 Ref. 014477001  
 Ref. 014477002

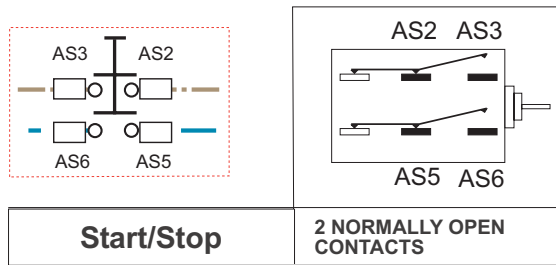

#### Description of the functions of the switch:

##### Start/Stop switch

Switches the power supply to the washing machine on or off.

### 10.0 Logarithmic Potentiometer 50 kOhm with 8 fixed positions for spin speed selection

used on: Washer ASKO WAM1712W Ref. 010477003  
 Washer Eurotech EWF272EL Ref. 010477006  
 Washer Eurotech EWF272ELGH Ref. 010477007

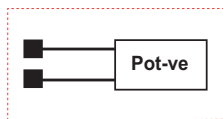
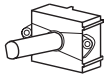

Symbol on wiring diagram

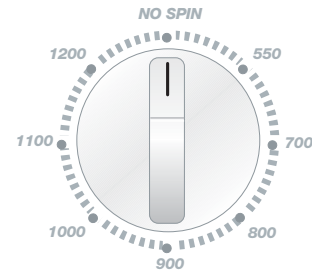

When the drying time is set with the knob, the Led "DRY" remain activated until the button Start is pushed ON. The Drying function could be activated only for the Cotton, Synthetics and Quick wash programmes.

#### Spin speed setting knob

The knob allows the maximum spin speed to be modified and/or reduced to zero. The set spin speed is displayed by the LCD or by the leds above the button. The initial speed setting displayed is the maximum allowed for the set program. The spin speed can also be modified during the wash cycle.

**NB: For combination Washer/Dryer:**  
Excluding the spin also excludes the DRYING function.

### 11.0 Logarithmic Potentiometer 36 kOhm with 12 fixed positions for drying time selection

used on: Combination Washer/Dryer EUROTECH EWC177W Ref. 014477001  
 Combination Washer/Dryer ASKO WCAM1812 Ref. 014477002

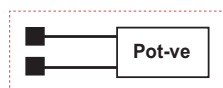
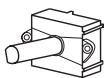

Symbol on wiring diagram

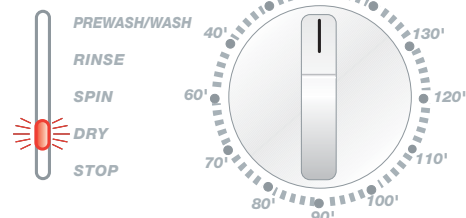

## TECHNICAL DATAS

### 12.0 Wash program selection potentiometer (used only on Electronic machines).

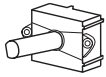

Combination Electronic washer/driers are fitted with a positive 36 kOhm logarithmic potentiometer with 12 fixed positions. Its use depends purely on the number of programs for which the appliance has been designed. The maximum Ohmic resistance is the reference value used to start the Autotest procedure.



#### Important:

The positions in red are those used for the various phases of the **autotest**.

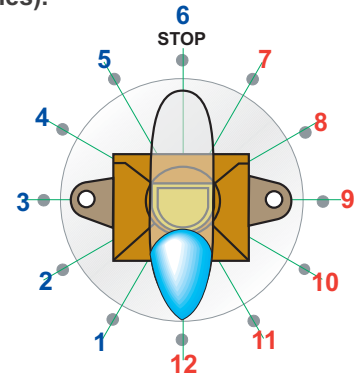

36 kOhm with 12 fixed positions

#### Program selector.

The start of a particular program is commanded by a wash code sent by the program selector (potentiometer) to the control unit.

The process also depends on the pressure switch signal: an **OPEN P11 - P14** contact enables the water feed or spin, while a **CLOSED P11 - P14** contact enables the motor to run during the wash and the heating phase.

The thermistor, tachometric and optional button signals are important for enabling the control unit microprocessor to run the required program. Note that each wash code of the program selector corresponds to a number of operations managed by the microprocessor.

### 13.0 Two way cold water solenoid valve for Combination Washer/Dryers.

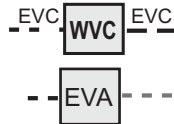
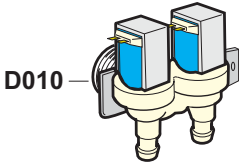

1) Wash	Flow rate:	MAX. 12	l / min
	Working pressure:	MIN. 0,05 - 1	MPa
2) Dry	Flow rate:	MAX. 0,35	l / min
	Working pressure:	MIN. 0,05 - 1	MPa

### 13.1 One-way hot water solenoid valve for Washer and Combination Washer/Dryers.

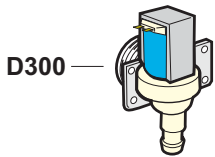

1) Wash	Flow rate:	MAX. 7	l / min
	Working pressure:	MIN. 0,05 - 1	MPa

### 13.2 One-way cold water solenoid valve used only for Washers.

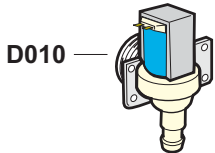

1) Wash	Flow rate:	MAX. 10	l / min
	Working pressure:	MIN. 0,05 - 1	MPa

### 14.0 Cold plug type thermo-actuators with 220-240 V – 50 Hz power supply for feeding water to the detergent dispenser:

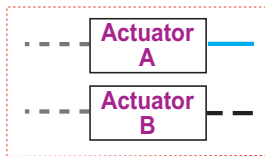

**THERMO-ACTUATOR B**

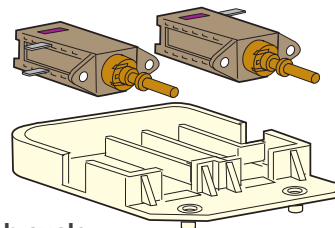

**THERMO-ACTUATOR A**

#### Description of water distribution during a wash cycle

##### PREWASH PHASE:

Both thermo-actuators are inactive.

During the **drain** phase, thermo-actuator **A** is active.

##### WASH PHASE:

Thermo-actuator **A** is active.

##### CONDITIONER PHASE:

Thermo-actuator **B** is active.

## TECHNICAL DATAS

### Water fill principle

At the start of the wash program, the control unit, according to the program selected, commands the solenoid valve to feed water to the appliance providing the pressure switch authorises the action (the pressure switch must be OFF). When the required water level has been reached, the control unit closes the solenoid valve. If the pressure switch detects excess water entering the appliance, it sends a signal to the control unit which then starts the drain pump.

### Heating phase principle

The heater element switches on when pressure switch contact P11-P14 is closed (water in the tub). A traditional thermostat to interrupt the power supply to the heater element is not provided. The control unit receives the Ohmic value of the resistance and switches off the heater element when the correct temperature has been reached. In the case of a fault in the heater element and/or thermistor, a maximum heating time of 30 minutes for each heating phase is provided. Should a fault of this type arise, the washing machine will complete a cold wash program though will take more time.

### Heating phase principle for electronic washers

The heating element begins working, when the contact P11-P13 of the pressure switch they is closed.

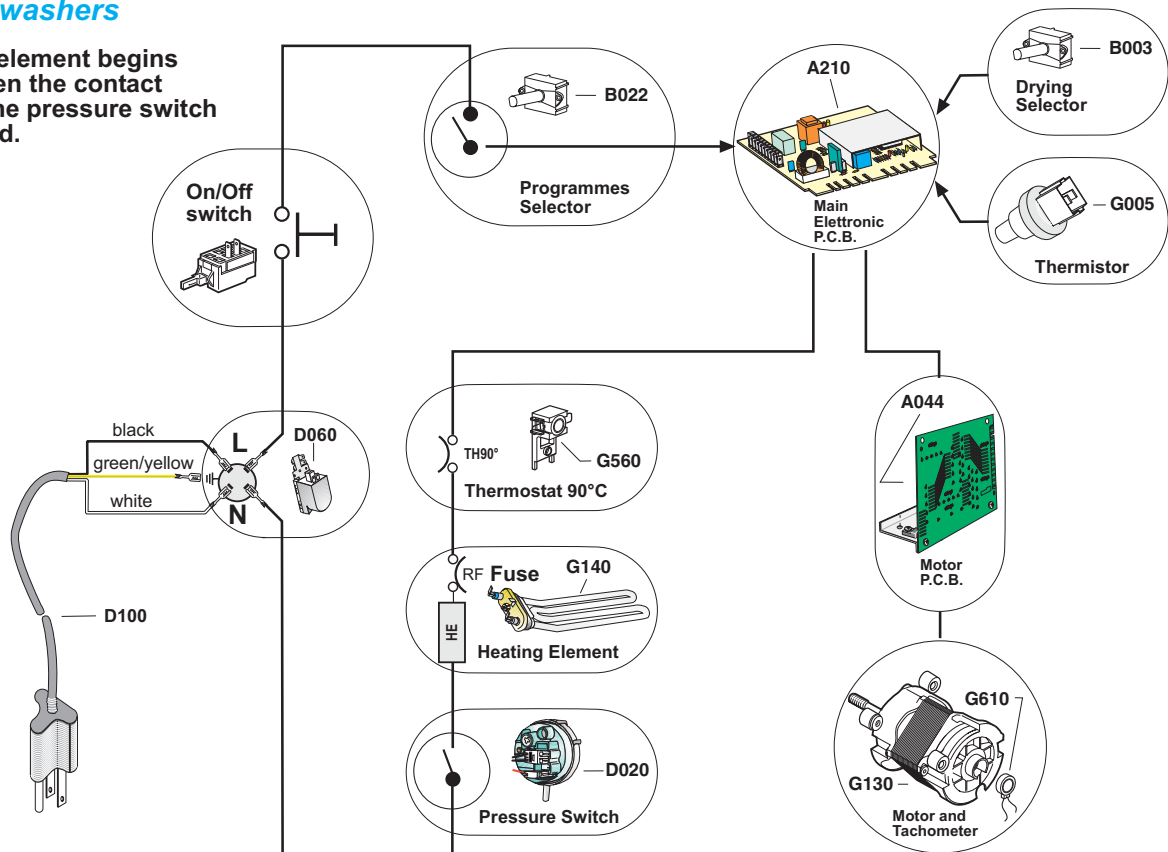

### COOLING

The cooling phase is necessary in order to ensure that the water pumped to the drainage system is not too hot. This is always carried out for the **COTTON** program if the temperature is higher than **70°C**. The water is gradually cooled down by allowing cold water to enter after the last wash cycle and before draining. The control unit feeds the cold water for one minute, pauses one minute then drains. During **DELICATE** and **SYNTHETIC** programs, the cooling is always carried out before draining by activating the solenoid valve for 10 seconds.

### WASH LOAD BALANCE CONTROL

The washing machines are fitted with an electronic balance control which is active in all the spinning phases. At the start of the spin cycle, the load balance is checked by the control unit. If the load in the drum is unbalanced, the washing machine attempts to start the spin a number of times. If the control unit detects that the load is very unbalanced, the entire spin cycle may last as long as 20 minutes (even if the display still shows 12' (minutes)).

## TECHNICAL DATAS

- 15.0 Main Motor Asincronous 3 phases with tachometer  
115V - 60 Hz

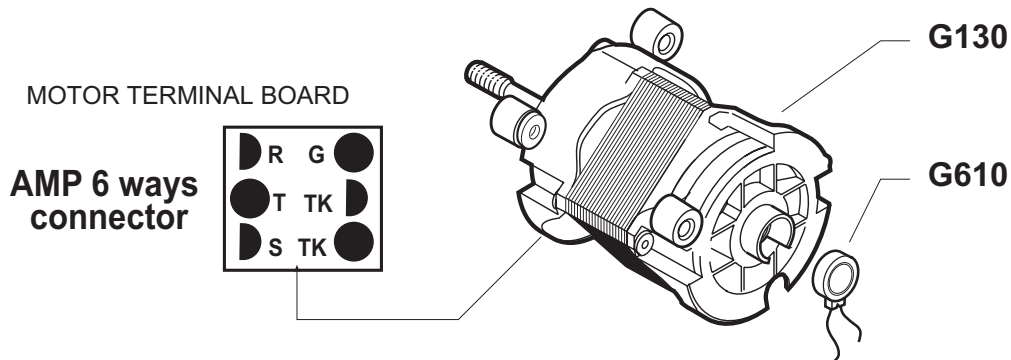

DATAS VALID FOR ALL MOTORS

Tachymeter generator TK-TK 29 Ohm $\pm$  0,5 Ohm  
Tolerance for winding measurement  $\pm$  0,5%

**Note:** There may be slight variations in ohmic resistance between motors produced by different manufacturers.  
See also motor nominal data identification plate.

- 16.0 Motor Control Unit 115v - 60Hz.

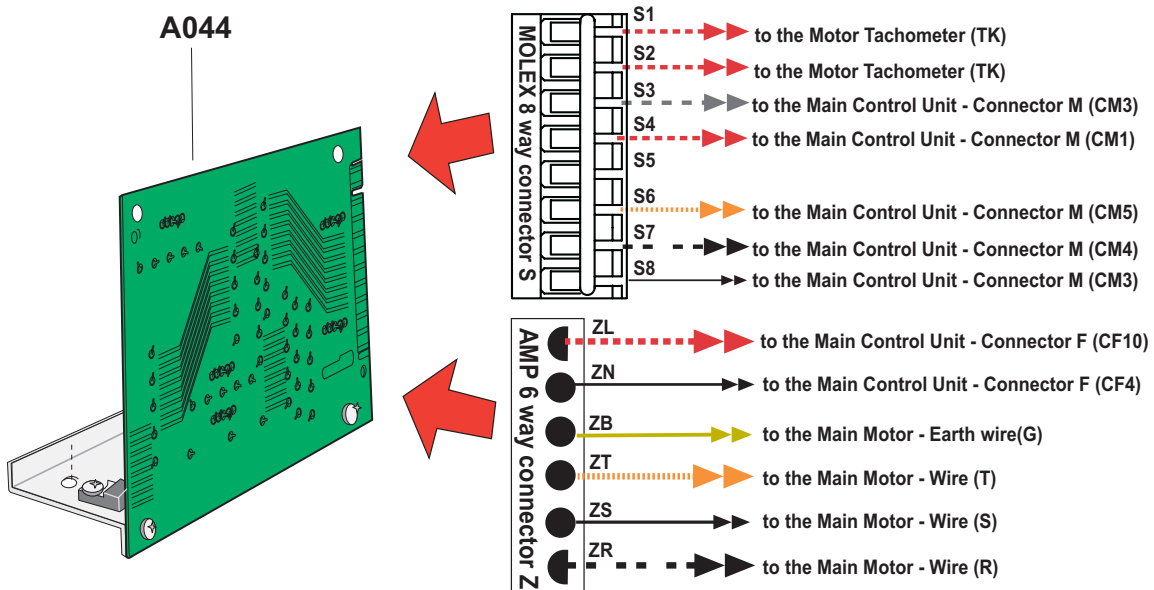

## TECHNICAL DATAS

### 15.0 Electronic control unit contacts

#### Electronic washers - version with 2 thermo-actuators

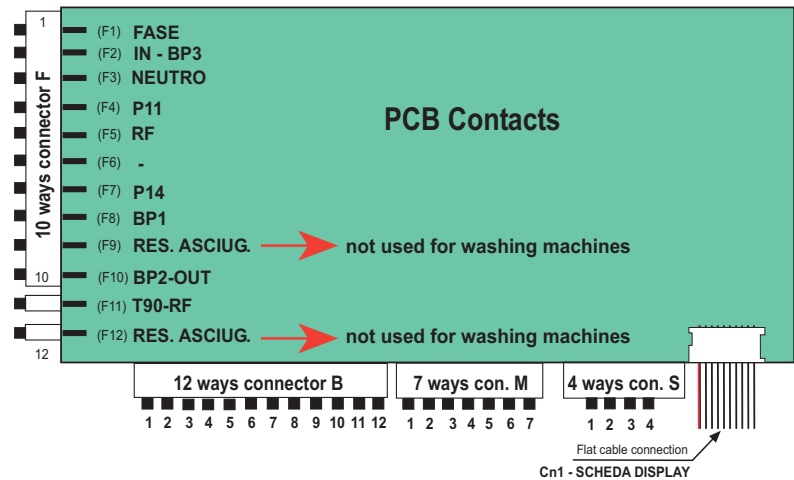

#### FUNCTIONS OF CONTACTS

- F1** receives power from the **ON-OFF** button
- F2** feeds door catch contact **BP3**
- F3** current output to **ON-OFF** button
- F4** feeds pressure switch contact **P11**
- F5** feeds the **heater element** through the internal safety **thermo-fuse**
- F6** -----
- F7** receives the pressure switch level reached signal from contact **P14**
- F8** feeds door catch contact **BP1**
- F9** receives the return signal from the drying heating element through **safety thermostat T170°C** which, when the temperature is reached, opens the contact - **used only for combination washer/dryer.**
- F10** feeds door catch contact **BP2**
- F11** receives the return signal from the washing heating element through **safety thermostat T90°C** which, when the temperature is reached, opens the contact
- F12** receives the return signal from the drying heating element through **thermostat T150°C** which, when the temperature is reached, opens the contact - **used only for combination washer/dryer.**
- B1-B3** feeds Hot Water Solenoid Valve **EVH**
- B1-B2** feeds Cold Water Solenoid Valve **EVC**
- B4** common **Thermo-actuator A** and **Thermo-actuator B**
- B5** power supply **Thermo-actuator A** (Wash)
- B6** power supply **Thermo-actuator B** (Softener)
- B7-B8** power supply **Drain pump**
- B9** return signal from **pressure switch overflow safety (P16)**, starts the pump.
- B10** common **Drying Water Solenoid Valve (EVA)** and **Drying Fan Motor (VA-BL1)** - **not used for washer.**
- B11** power supply **Drying Water Solenoid Valve (EVA)** - **not used for washer.**
- B12** power supply **Drying Fan Motor (VA-BL2)** and **Drying Fan Motor Capacitor (VA-C)** - **not used for washer.**
- M1-M2-M3-M4-M5** power supply **Motor**
- M6-M7** return signal from **thermistor**
- S1-S2** receives signal from **program selector potentiometer.**
- S3-S4** receives signal from **spin speed potentiometer (Washer)** or from **drying time potenziometer (Washer/Dryer)**
- Flat cable** receives information from the pushbutton circuit board (wash options).

#### IMPORTANT:

Before replacing the control unit, use the AUTOTEST to ensure that the electrical components are in working order, that the contacts of the control unit connections are good and that the mains voltage is within the required limits.

## Pushbutton specifications

---

### Description of the functions of the selector buttons:

#### Start button

This button confirms the previously set functions and starts the program.

The button is not normally lit, but lights up to indicate the cycle is running only if the door catch is closed.

When the program selector is positioned on "**Stop**", the cycle is stopped and the button light flashes.

#### Prewash button

This button includes or excludes the prewash (see specifications) from the wash programs that accept the function (see table).

The button is not normally lit but lights up when the function has been selected.

#### Extra rinse button

This button includes or excludes the extra rinse (see specifications) from the wash programs that accept the function (see table).

The button is not normally lit but lights up when the function has been selected.

## CONTROL PANEL

---

### "Program and Temperature" selector knob

This knob is used to select the type of wash and the most appropriate temperature for the items to be washed.

Positioning the knob at the "**STOP**" position will reset the program.

If, for any reason, you want to change the set wash program or add more washing to the load during the wash cycle, simply place the programmer knob on "**STOP**". Then re-position the knob on the new program and press the "**START**" button.

At this point, before the program restarts, any water in the machine will be drained.

**N.B.** After carrying out this operation, check that there is detergent in the appropriate compartment ---- and add if necessary.

**Warning:** Only use this function if strictly necessary and then only if the program to reset has been running for less than 3 minutes. Before opening the door after a reset, wait 2 minutes for the locking mechanism to release.



# MANUAL SELF-TEST OF CIRCUIT BOARDS ON MODEL MINI-SEL with 2 knob control panels

466000001-1-UK  
07/03/2003

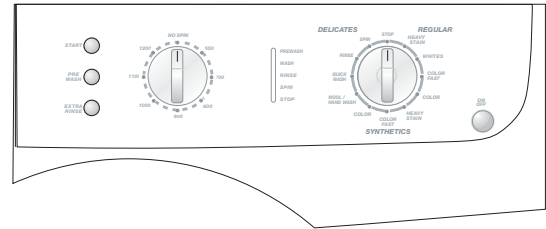
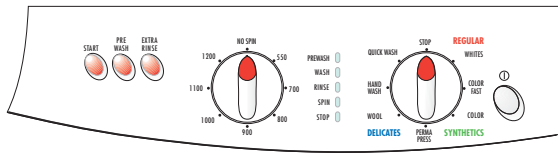

## START CONDITIONS FOR MANUAL SELF-TEST

- Set the **Programmer Knob** at **6-o'clock** position.
- Set the **Spin Speed Knob** at **9-o'clock** position.
- Keep the **PREWASH** Button pressed and at the same time switch the machine on by pressing the **On/Off** button.

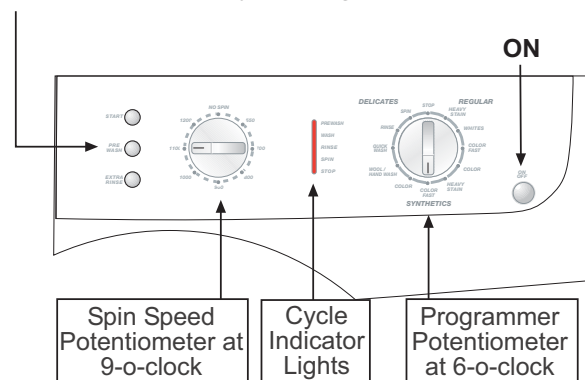
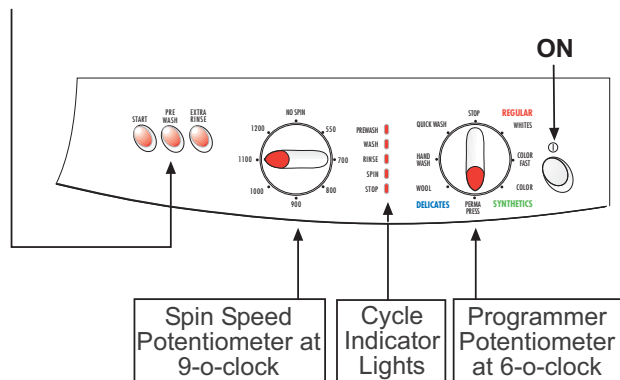

The five LEDs indicating the "Cycle Indicator Lights" will LIGHT UP.

## THE TEST CHECKS

- The Temperature Probe (**THERMISTOR**)
- The OFF position of the Pressure Switch (no water in tub)
- The door catch interlock

If the results of these checks are positive, the top LED will switch off.

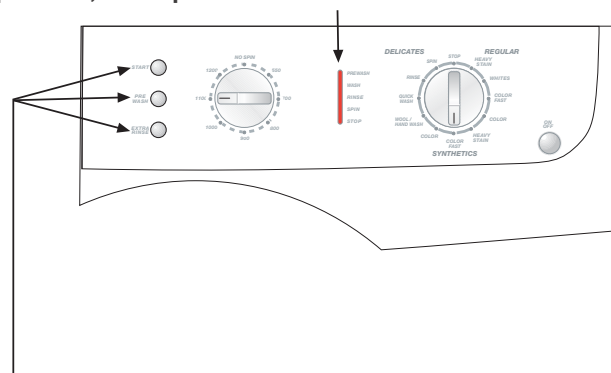
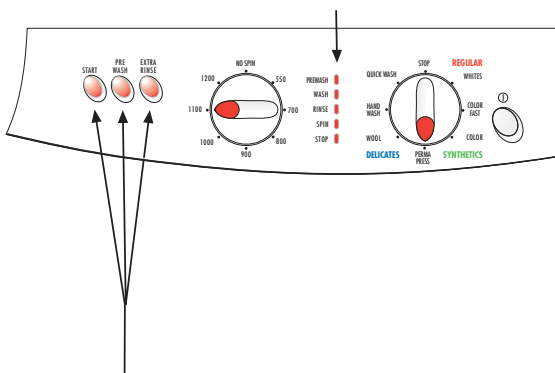

The luminous buttons change their status from **On** to **Off** or vice versa, each time they are pressed. The only exception is the "**START**" button which only lights up while it is being pressed.

At this point, the test can be continued using the programmer knob as explained in chapter "**MANUAL TEST SELECTION**"

## DIAGNOSTICS TABLE









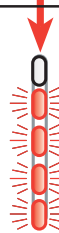

The electronic control unit also allows individual components to be tested by varying the knob setting and maintaining the other conditions unchanged.

Once the autotest function has been started, the required test can be selected by placing the knob in the appropriate position. Each position of the knob corresponds to a component test.

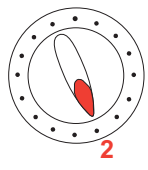
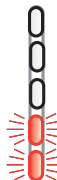
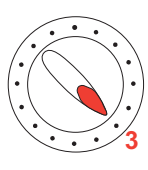
Starting from the start position (6-o'clock) and rotating the knob anticlockwise one position at a time there are **six** tests that can be carried out. Except for the first test, which is carried out by the control unit itself, in order to verify the result of the test, the behaviour of each tested component must be monitored..

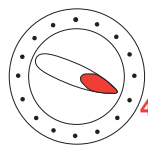
The control unit takes a few seconds to pass from one test to the next. The acceptance of the test is signalled by the leds or by a display code indicating the program corresponding to the position of the knob in autotest. From this point on, all the suspect components can be tested.

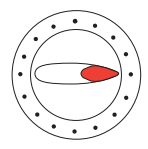
The correspondence between the reference position of the knob and a wash program is purely indicative, in that this is linked to the appliance model in question.

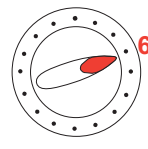
SUMMARY TABLE		Led on light	Position of knob index mark
<b>Test 1</b>	<ul style="list-style-type: none"> <li>- Start position, all the functions are deactivated.</li> </ul> <p>The control unit automatically tests the operation of the thermistor, the pressure switch OFF condition (no water in tub), the program selector and the door catch closed condition.</p>	 <p>PREWASH/WASH RINSE SPIN DRY STOP</p>	 <p>6-o'clock position 1</p>
<b>Test 2</b>	<ul style="list-style-type: none"> <li>- Fills with water through the cold solenoid valve until the pressure switch trips in.</li> <li>- Actuator <b>A</b> and actuator <b>B</b> are <b>OFF</b> (water enters the prewash detergent dispenser)</li> </ul>  <p>This procedure tests the operation of the <b>cold water solenoid valve</b> and the <b>pressure switch</b>.</p>		 <p>2</p>
<b>Test 3</b>	<ul style="list-style-type: none"> <li>- The heater element is activated (only with water)</li> <li>- The motor rotates alternately in both directions (45 revolutions clockwise, pause, 45 revolutions anticlockwise).</li> <li>- Thermo-actuator <b>A</b> only is activated (water enters the wash compartment).</li> </ul> <p>This procedure tests the operation of the following components:</p> <ul style="list-style-type: none"> <li>- <b>heater element; wash motor</b> and <b>thermo-actuator A</b>.</li> </ul>		 <p>3</p>
<b>Test 4</b>	<p><b>N.B.: In Autotest, the "No Spin" function is disabled.</b></p> <ul style="list-style-type: none"> <li>- The drain pump is activated and the spin runs at the preset speed.</li> <li>- Thermo-actuator <b>B</b> only is activated (water enters the softener compartment)</li> </ul> <p>This procedure tests the operation of the following components:</p> <ul style="list-style-type: none"> <li>- <b>drain pump, spin motor</b> and <b>thermo-actuator B</b>.</li> </ul>		 <p>4</p>
<b>Test 5</b>	<ul style="list-style-type: none"> <li>- 10" fill with hot water solenoid valve where fitted (with level pressure switch off)</li> <li>wash motor rotation with different rpm and direction according to the circuit board model.</li> <li>- Actuator <b>A</b> and actuator <b>B</b> are <b>ON</b> (water enters the softener dispenser)</li> </ul> <p>This procedure tests the operation of the hot water solenoid valve (where fitted and only with pressure switch OFF) and the wash motor.</p>		 <p>5</p>
<b>Test 6</b>	<p>This procedure tests the operation of the following components:</p> <ul style="list-style-type: none"> <li>- drying solenoid valve.</li> <li>- drying fan motor</li> <li>- drying heater element</li> </ul>		 <p>6</p>

# DIAGNOSTICS TABLE

## TROUBLESHOOTING GUIDE

Before carrying out any operations on a component check the quality of the electrical connections to the electronic control unit.

Check the condition of the wiring harness (for wear, twists, breakages) and the connections.

Always check that the contacts of the connections on the electronic control unit are tight.

Always start by checking the other components involved, and then check the electronic control unit last.

### The program will not start.

Try to start the manual autotest, if the control unit does not enter autotest mode, check the connections on the control unit itself. If the connections are good, replace the control unit.

In the case where the autotest is effected, wait until the top "wash program" led switches off. If this does not happen, then the control unit has discovered a fault in one of the three components under test:

- the door catch
- the pressure switch
- the thermistor.

The door catch does not close the contact.

- Check that the connections have been properly made.
- Use a Tester to check the voltage between contact BP3 and BP1. If there is no voltage:
- Check that power is arriving at the control unit. If there is no power, find out why.
- If there is power arriving at the control unit but there is no current at the door catch, use a Tester to check whether there is voltage at the outputs of the control unit to the door catch. If there is no voltage, replace the control unit.
- If there is power between contact BP3 and contact BP1, replace the component.

If the door catch closes properly, check the pressure switch.

Disconnect the pressure switch from the wiring and retest. If the test is ok, replace the component, otherwise if the problem persists:

- Check that the connections have been properly made.
- Check that the pressure switch pipe and the compression chamber are not blocked.
- Disconnect the wiring from the thermistor, fit a new thermistor that is known to be working. Retest and if ok replace the component (the test is only valid if the washing machine is cold).

If the thermistor is working, replace the control unit.

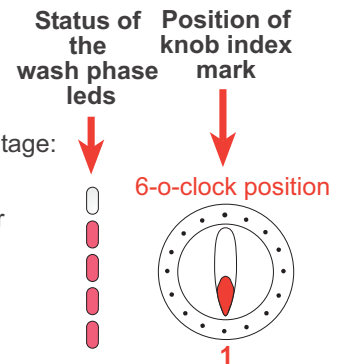

### Water does not enter the tub

Check that the water feed valve to the washing machine is open.

Put the control unit in Autotest mode as described previously. Carry out Test 2 of the manual autotest procedure (testing the solenoid valve). The tests starts when the leds switch off:

- Use a Tester to check the voltage at the ends of the wires connecting the solenoid valve to the control unit.
- Use a Tester to check the continuity between the two contacts of the solenoid valve, if the circuit is open replace the component.
- If all the above tests result positive, replace the control unit.

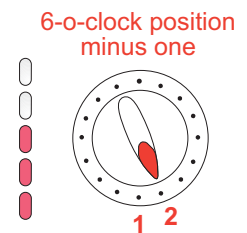

### The washing machine does not heat the water in the tub.

Put the control unit in Autotest mode and carry out Test 2 to allow water to enter the tub (this is required for the heater element to function).

With water in the tub, carry out Test 3 of the manual Autotest. Wait until the leds switch on (the washing machine is in Autotest mode) to test the heater element:

- Use a Tester to check the continuity between the two contacts of the heater element, if the circuit is open replace the component.
- Use a Tester to check the continuity at the ends of the wires connecting the heater element to the control unit.
- Use a Tester to check the continuity between the two contacts of the T90° safety thermostat, if the circuit is open replace the component.
- If all the above tests result positive, replace the control unit.

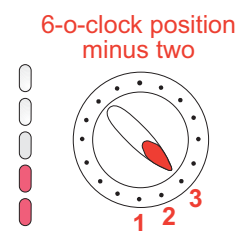

## DIAGNOSTICS TABLE

---

### The motor does not turn properly during a wash and/or spin

Put the control unit in Autotest mode and move the programmer knob to the Test 4 position. Wait for the leds to light up (the washing machine is in Autotest mode) and then test the motor. If the motor does not run properly:

- Disconnect the motor from the wiring terminal board.
- Use a Tester to check the continuity at the ends of the wires connecting the wiring terminal board to the control unit and check that the connectors are not damaged or dirty.
- Replace the control unit with one known to be in working order and check that the motor runs. If the motor runs replace the control unit, otherwise replace the motor.

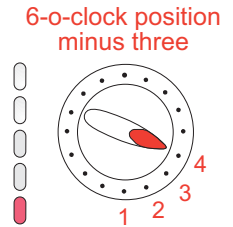

### The washer/drier does not drain

Check that the washer/drier filter or the user's drains are not blocked. Put the control unit in Autotest mode and move the programmer knob to the Test 4 position. Wait for the leds to light up (the washer/drier is in Autotest mode) and then test the pump:

- remove the wires from the pump and check the continuity between the two terminals of the drain pump itself.
- if the circuit is open, replace the pump.
- if the circuit is closed, remove the pump from the washing machine and use a screwdriver to check for any foreign bodies in the scroll.
- use a tester to check the continuity in the pump power supply wires. If the tests prove negative replace the control unit.

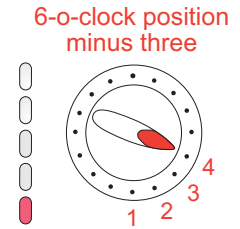

### Water flows into the tub continuously.

- Check that the solenoid valve is working by carrying out the appropriate autotest for that particular component.
- Check that the pressure switch is working by carrying out the appropriate autotest for that particular component.
  - Check that there are no leaks from the tub unit.
  - Remove the pressure switch pipe from the drain coupling and check that there are no holes in the pipe.
  - If all the above tests result negative, replace the control unit.

## SAFETY

After eight failed attempts to start the motor (either in wash or spin mode), the control unit passes to the end of the cycle and the **End** indicator light flashes. (motor rotor blocked or tachometric open).

If the control unit does not detect the pressure switch empty condition after twenty minutes of pump running time, it passes to the next step. (Pump blocked).

If, after fifty minutes of heater element operation the set temperature has not been reached, the control unit advances and continues the cycle as normal.

---