

# Nexxt Washer Training/Repair Manual

- [Fascia panel disassembly.....](#) 2
- [Top & rear panel disassembly.....](#) 4
- [Tub, drum & dampers.....](#) 5
- [Drum drive motor.....](#) 6
- [Drain pump.....](#) 7
- [Front panel disassembly.....](#) 8
- [Installing door seals.....](#) 10
- [Heater & NTC.....](#) 11
- [Door lock.....](#) 12
- [Vibration checklist.....](#) 13
- [Sensors.....](#) 14
- [Test program.....](#) 17
- [Fault codes.....](#) 19
- [Troubleshooting.....](#) 22
- [Oversudsing.....](#) 25
- [Quiz.....](#) 26

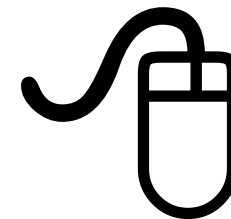

**Click onto any link to  
jump to that page**

# Disassembly – Fascia (Control) Panel (1)



To remove fascia panel to access control module & dispenser, remove (4) T-20 Torx front/side screws and lift panel up. Caps over screws can be removed using fingernails or a sharp knife – take care not to scratch fascia panel or caps.



When reassembling panels, tuck rear tabs under top panel 1<sup>st</sup>.



Knobs are permanently attached to panels and cannot be removed.

# Disassembly – Fascia (Control) Panel (2)

Control modules can be readily removed from fascia panels, but there's a knack to it – must use the procedure below exactly as shown.

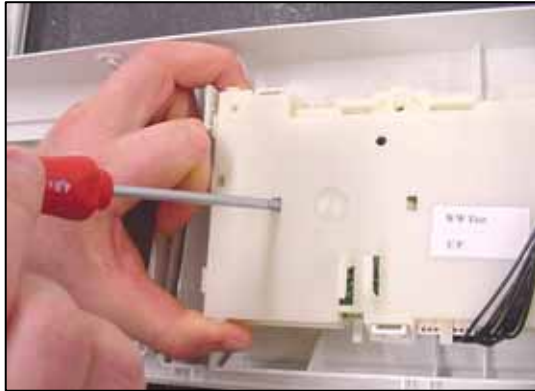

Start from left side



Pry outer & inner tabs together L – R

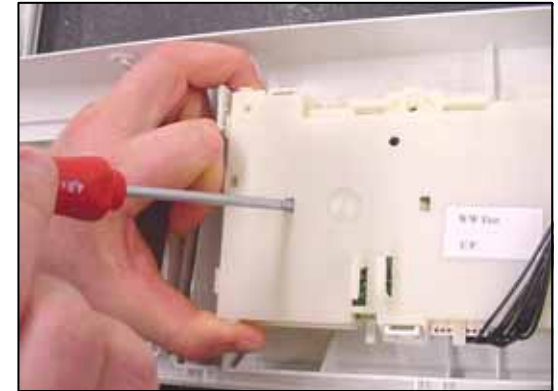

Pry out (3) inner tabs + all outer tabs



**HINT:** Don't force modules out from fascia panels to avoid breaking plastic parts. If modules don't come out easily, the procedure hasn't been followed and plastic parts will break.



**HINT:** Don't remove the wire holders – clip off wire ties instead. Carry extra wire ties to reattach wire harnesses.

**HINT:** The knob does NOT have to be removed to remove the control module. The module lifts off completely from the panel, knob & buttons.

**NOTE:** Some control modules have been replaced since fault codes stored in module or motor control can't be cleared. Modules are operating properly and shouldn't be replaced to clear fault codes.



# Disassembly – Top & Rear Panels (1)

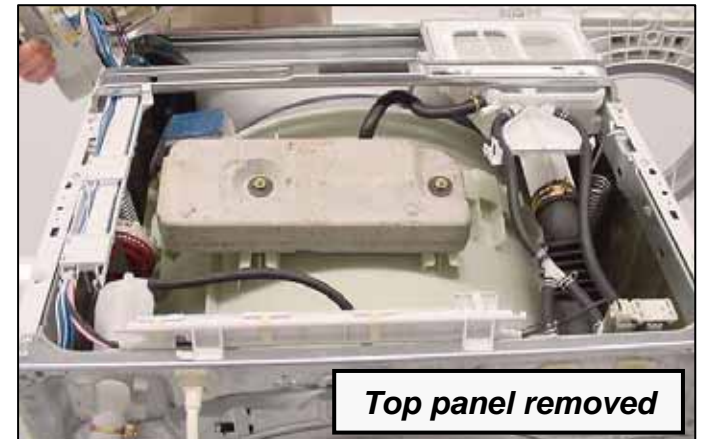
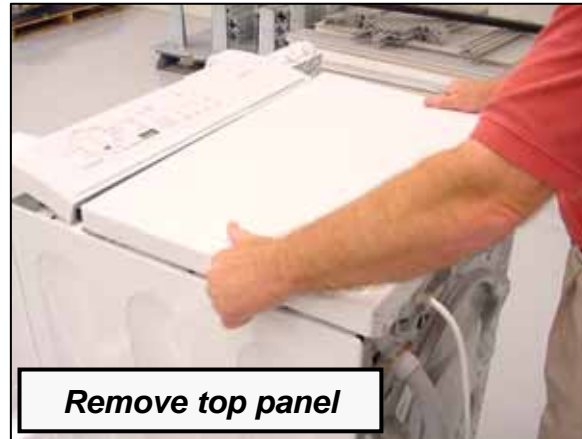
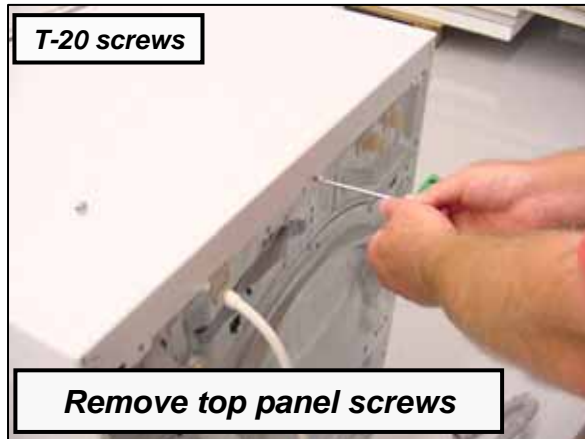

To remove rear panel to access drive motor and rear of drum, remove (18) T-20 screws. There's no need to remove the top rear panel (with "H" & "C" stampings).

To remove top panel (for easier parts access), remove (3) T-20 screws and slide panel to rear of washer.

# Disassembly – Tub, Drum & Dampers

## Outer drum (tub)

The tub consists of two durable *Polinox* plastic shells screwed to each other.

### To remove outer tub:

1. Disconnect wire harnesses (as needed) – wire ties can be cut off, but clips shouldn't be cut.
2. Remove front panel, rear panel, fascia panel (with detergent dispenser) and top panel.
3. Remove door seal, top counterweight and both side counterweights.
4. Disconnect dampers from tub and slip belt off of tub.
5. Remove tub through **rear** of washer.
6. Remove (18) T-25 Torx screws holding front & rear tubs together.

**NOTE:** Rear drum bearings are factory press fit into rear outer tubs and cannot be removed or serviced.

**HINT:** When installing outer tub bolts, screw them in by hand onto the first thread. Do not overtighten or cross-thread them.

**HINT:** Unlike WFL2060 & WFR2460 washers, **no** clips hold tubs together – **no** drilling or cutting is needed.

All washers starting with index \_\_/04 have new resin tubs, front and rear, with a translucent beige-tan color compared to older blue-white tubs. To avoid leaking, tubs **must** have the same resin front and rear, whether older blue-white tubs or new beige-tan tubs – front/rear tub resin types cannot be mixed.



**Comparing tub resins**

**NOTE:** You can see your fingers through new resin tubs



**Removing tub screws**

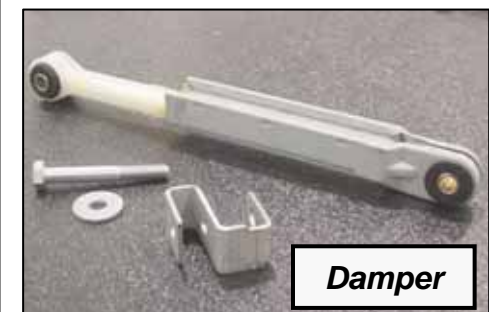

Rev 0 (1/17/08)



# Disassembly – Drum Drive Motor

## To remove drum drive motors:

- Remove rear panel
- Remove rear tub spring
- Remove drum belt
- Disconnect wire harnesses
- Remove two motor bolts, then pull motor out toward rear of washer

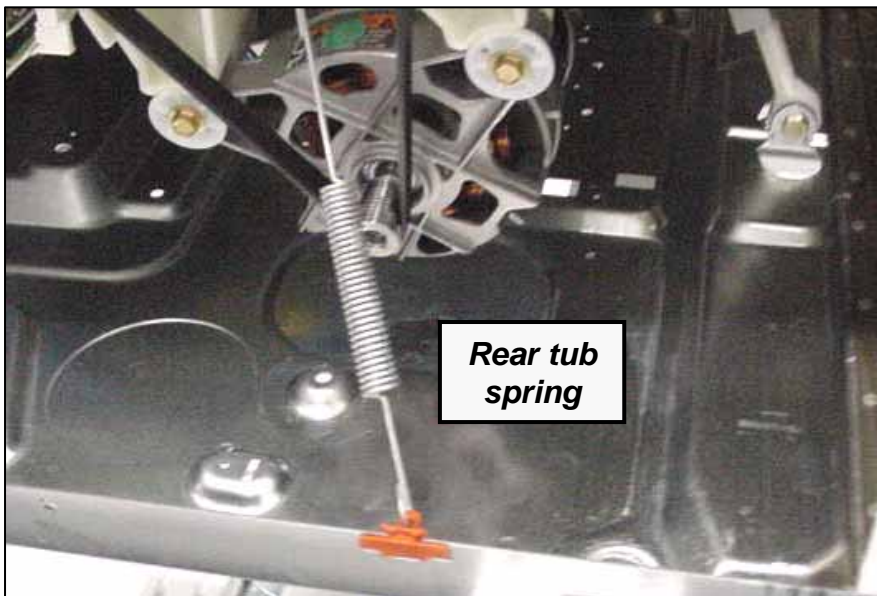

**WARNING:** The drum drive motor & tub are grounded through the motor control. Since the tub is plastic and the motor is isolated from the frame, its critical the ground leads from the tub, drive motor & motor control are connected properly.

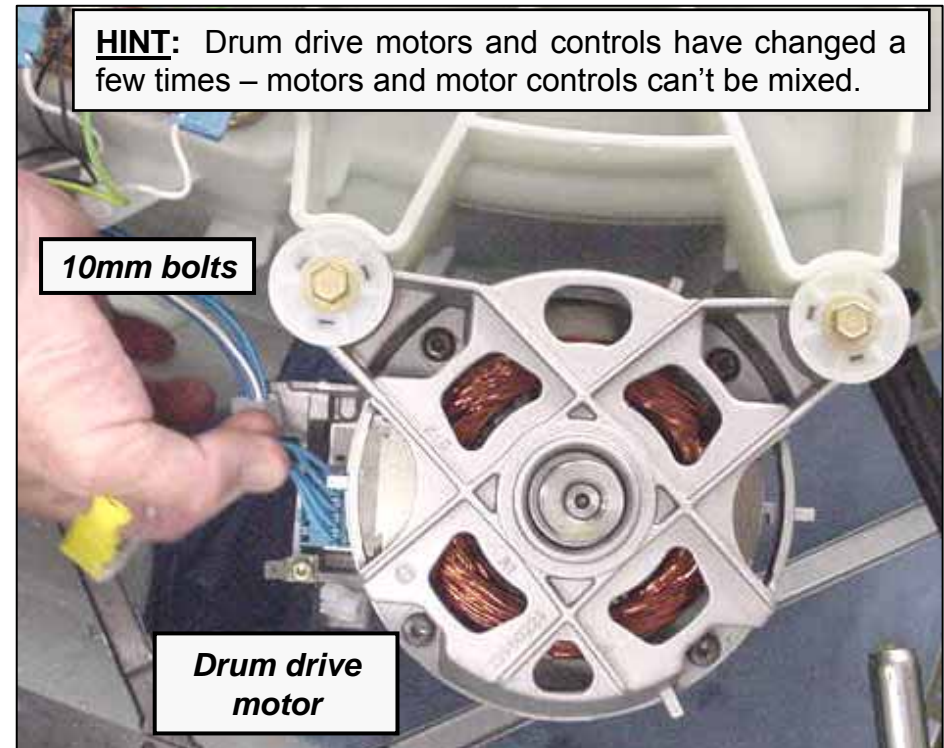

# Disassembly – Drain Pump

## To remove drain pumps:

- Remove front panel
- Loosen and remove hoses
- Disconnect **green** door latch release cord.
- Disconnect wire harness
- Carefully slide pump toward rear of washer, then lift it out of washer (taking care to not damage the four rubber feet).



**Rear access is best for most repairs.**



**Drain pump**

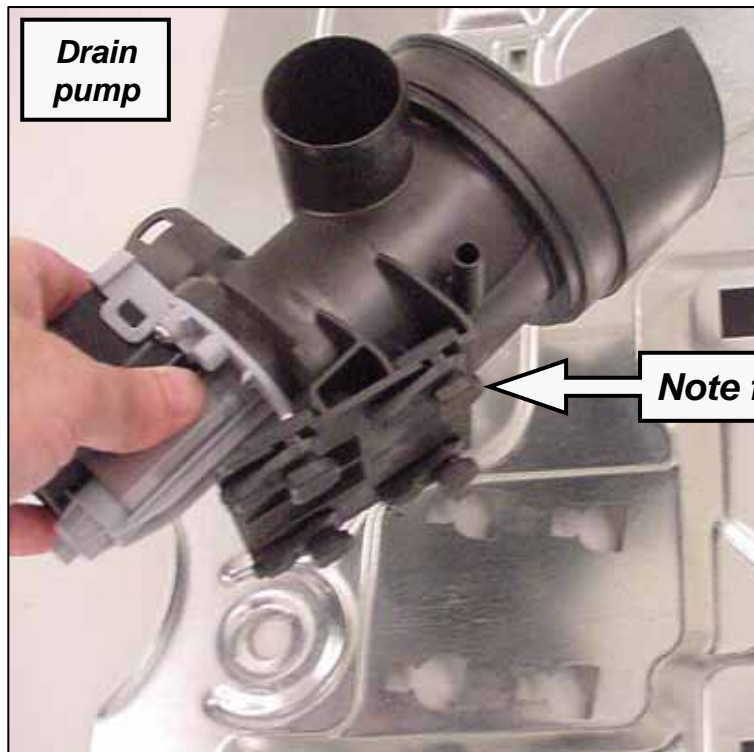

**Drain pump**

**Note four mounting feet**

**CAUTION:** If opening drain pump access cover, take care to not get cut on front panel opening.

**Current production pumps are beige color – earlier WFMC pumps were black.**

**HINT:** Drain pumps are mounted on four rubber feet to dampen vibration & noise. To remove drain pumps, carefully slide them toward rear of washers. To install them, carefully insert all four feet into notches in washer base, then slide them forward.



# Disassembly – Front Panel (1)



**Rear access is best for most repairs.**

**Remove hinge cover screws**



**Hinges cannot be reversed.**

**Remove hinge screws**



**Remove door seal spring**



**Remove door latch screws**

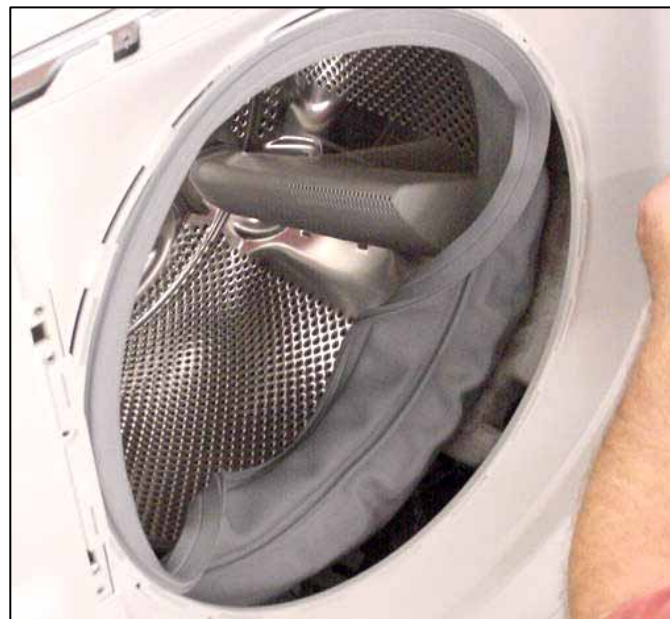

**Carefully remove front shield**



**Removing front shield**



# Disassembly – Front Panel (2)



*Remove top front panel screws*

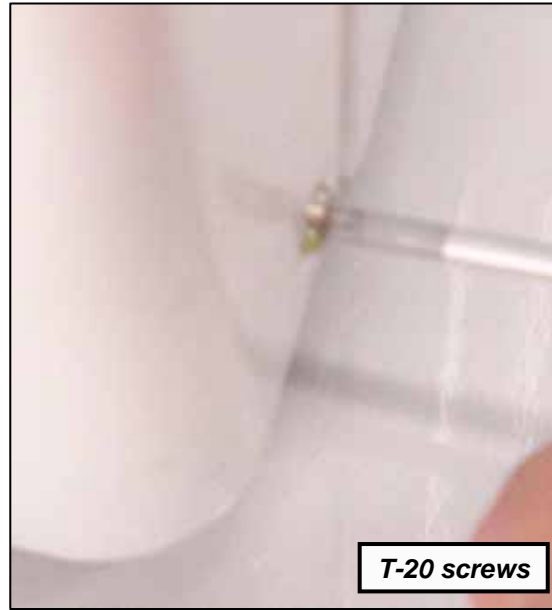

*Remove bottom front panel screws*

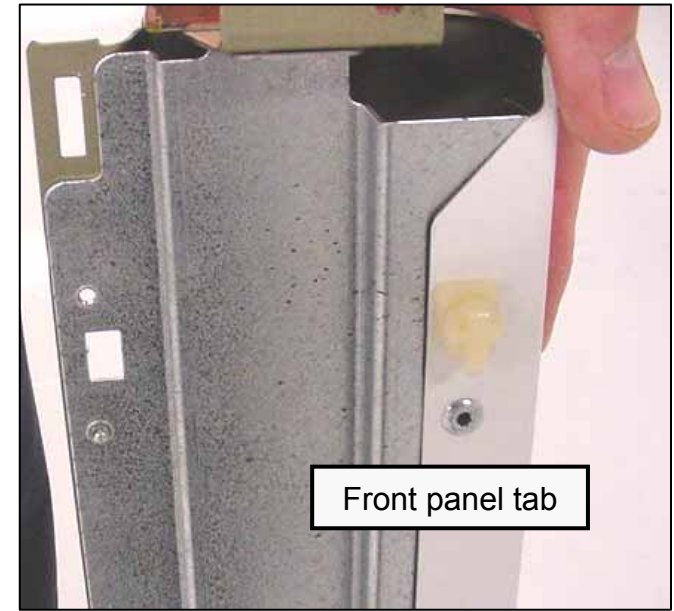

*Note front panel mounting tabs*



*Remove front panel*

**HINT:** Removing front panel at this point will make removing front counterweights easier.

**HINT:** Front panels are mounted using six (6) plastic tabs – three (3) on each side. Lift front panels up to remove them. When reassembling front panels, carefully align tabs and don't use excessive force to avoid breaking tabs.

**HINT:** Most washer screws require **T-20** Torx screwdrivers.

# WFMC Service Tips – Installing Door Seals

Certain repairs can involve removing or disconnecting the door seal (gasket) for access. To insure proper washer operation and prevent leaking, door seals must be reinstalled correctly.

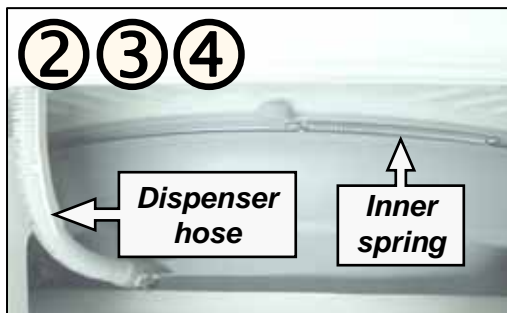
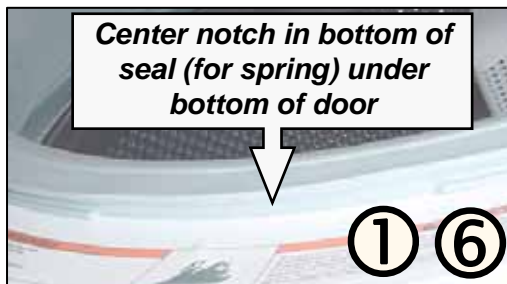

## To install door seals:

- 1) Align door seal so notch (for spring) at front is centered under bottom of door.
- 2) Carefully push rear of seal over front of tub so seal properly seats onto tub.
- 3) Stretch rear spring clamp over seal and insert into notch at rear of seal.
- 4) Using small hose clamp, attach dispenser hose to seal.
- 5) Work front seal lip over front shield flange (so lip "snaps" in). Tug around entire seal to check if seated.
- 6) Align clamp spring at door bottom, then insert front spring clamp into notch of entire left half of door seal (180° from top to bottom).
- 7) While pulling right side of spring using needle-nosed pliers, pull clamp into right side seal notch, then carefully release spring. Hold clamp next to front shield so clamp won't pull seal off.

**NOTE:** Check to make sure seal is seated after installation so no leaking will occur.

**TIP:** Left-handed servicers -- start the front spring clamp on the right side and pull the spring to the left.

# WFMC Service Tips – Heater & NTC

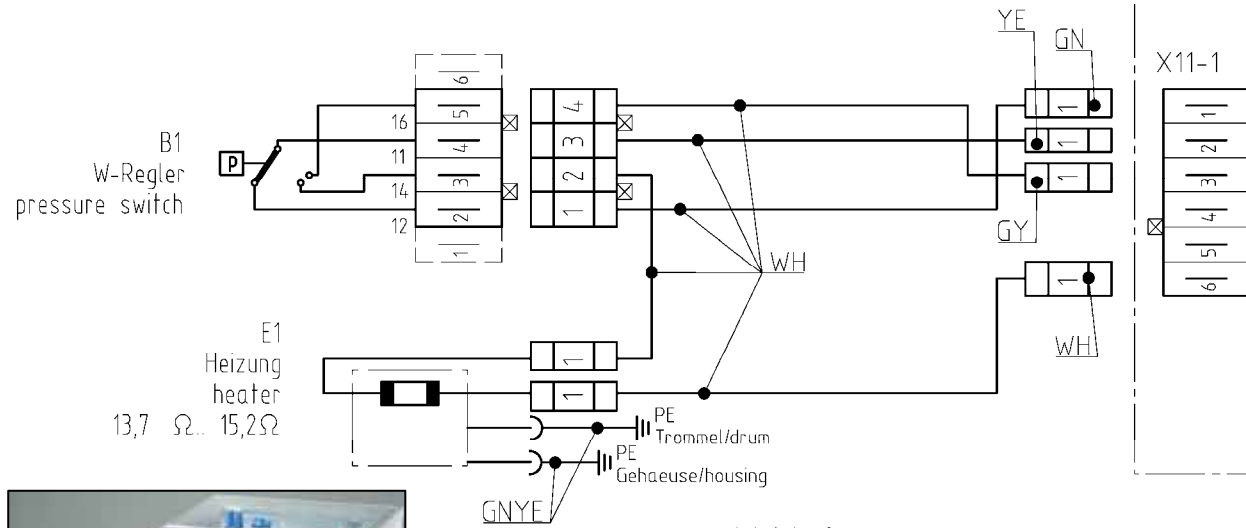

10°C (50°F):	36 – 44kW
20°C (68°F):	22.8 – 27.4kW
30°C (86°F):	14.8 – 17.5kW
40°C (104°F):	9.8 – 11.5kW
50°C (122°F):	6.6 – 7.7kW
60°C (140°F):	4.6 – 5.3kW
66°C (151°F):	3.73 – 4.29kW
73°C (163°F):	2.94 – 3.36kW
86°C (187°F):	1.93 – 2.19kW

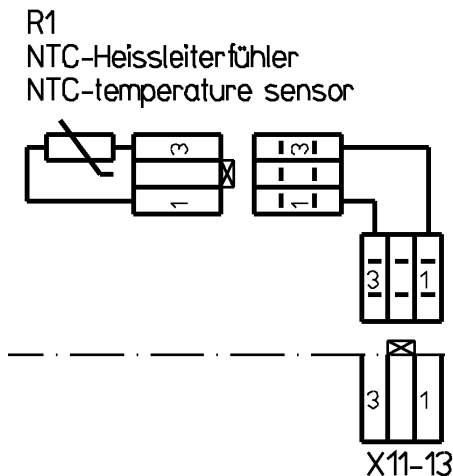

**HINT:** Heater can be removed from the back of the tub – remove rear panel for access.

**HINT:** NTC connector is latched – carefully pry latch with small blade screwdriver to remove it.



# WFMC Service Tips – Door Lock



**Door lock**



**HINT:** Can remove fascia panel & front shield to access door lock.

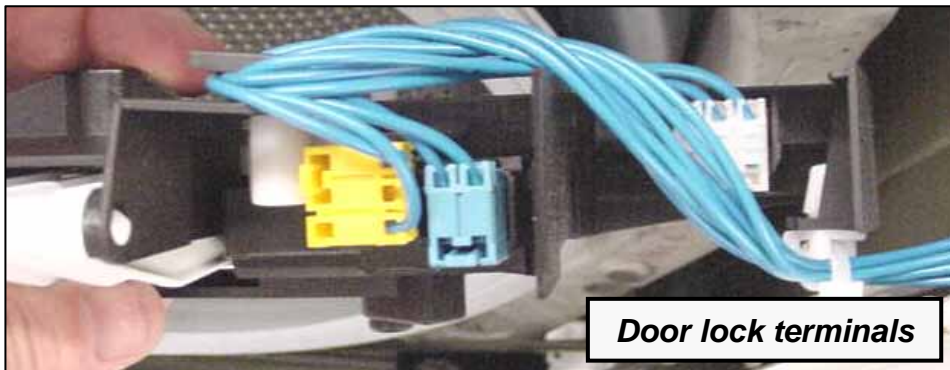

**Door lock terminals**

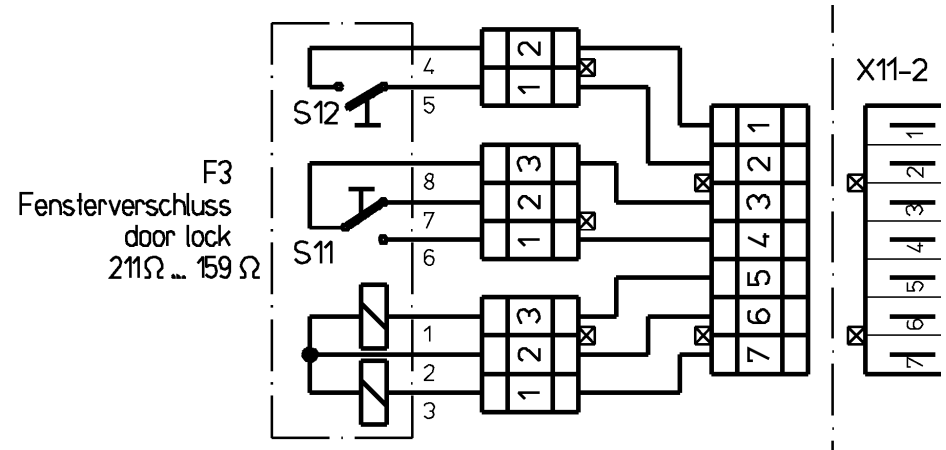

**HINT:** To remove the access cover to use the door lock manual release, insert a pointed object (or tool) into the hole, push in to release the latch and rotate the cover clockwise.

*Use care to avoid being cut on front panel after access cover removed.*

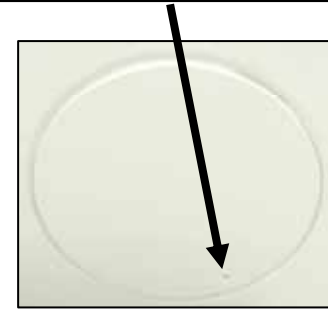

**HINT:** Door lock manual release cable is held to the right side of the drain pump by a clip. Simply pull on the cable to release the door.

Current production drain pumps are beige color – earlier WFMC pumps were black.

# WFMC Service Tips – Vibration Checklist

Front loaders can vibrate more than top loaders due to higher spin speeds. Checklist for occasional vibration:

- ❑ **Re-level washer** – Most vibration service calls come from improperly leveled washers. Re-level washers side to side and front to back using a bubble level. Each leveling leg must contact the floor firmly -- adjustments as slight as a ¼ of a turn (in leveling legs) make a difference since each leg must support 25% of the weight.
- ❑ **Raise front of washer** – Tests have proven raising both front legs of washers by 1/8 – ¼ inch (after leveling washers) lowers vibration.
- ❑ **Retract leveling legs to lower washer as much as possible** – When leveling, start with all legs fully retracted and extend only as necessary for proper level.
- ❑ **Tighten leveling leg locknuts** – Prevents loosening over time.
- ❑ **Remove all four shipping bolts** – Shipping bolts or their red plastic spacers have been left in washers. Make sure all four shipping bolts and plastic spacers (that have fallen inside washers) have been removed.
- ❑ **Use double-sided tape under leveling legs** – Helpful for washers on slick floors.
- ❑ **Check dampers** – Make sure dampers are working properly and all nuts are tightened.
- ❑ **Check springs** – Make sure all three springs are properly attached and are free to move.
- ❑ **Check bottom (base) panel for damage** – Bent bottom (base) panels can cause vibration. Check washers for shipment damage.
- ❑ **Check counterweights** – Replace any broken or cracked top and front counterweights. Tighten all bolts.
- ❑ **Reinforce floor** – Wooden subfloors may need reinforcing. More likely on upper floors.

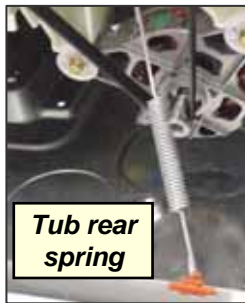

# WFMC64/84 Service Tips – Sensors

## **1A. Load Sensor (WFMC32/33/53)**

At a predefined points during the initial fill, the washer determines if it needs more water using a pressure switch. This is due to differences in the absorption of the laundry and the size of the loads.

## **1B. Dynamic Load Sensor (WFMC64/84)**

During the entire fill the washer continually adjusts for the size of the load and determines if more water is needed using an analog pressure switch and a flow meter.

## **2. Digital Temperature Sensor (WFMC32/33/53 & WFMC64/84)**

The thermostat monitors the temperature of the water and controls the length of time the heating element is on, ensuring the proper temperature for the chosen cycle.

## **3A. Suds Sensor (WFMC32/33/53)**

During the beginning of the 1st rinse/spin phase, the washer determines if there are excessive suds and automatically adds 2 rinses (if necessary). This is accomplished via the pressure switch and the motor synchronization system.

## **3B. Continuous Suds Sensor (WFMC64/84)**

Checking the pumping out phase of the main wash, the beginning of the 1st rinse/spin phase and the actual spin speed vs. the programmed spin speed, the washer determines if there are excessive suds and automatically adds up to 2 rinses (if necessary). This is accomplished via the pressure switch, analog pressure switch and the motor synchronization system.

## **4. Unbalanced Load Sensor (WFMC32/33/53 & WFMC64/84)**

During the final spin cycle the washer monitors the positioning and balance of the load. If the load unbalanced, the washer stops and adjusts the load up to 15 times and reduces the spin speed to finish the cycle. This is accomplished via the motor synchronization system.



# WFMC64/84 Service Tips – Water Flow Meter

## Flow sensor

The flow sensor measures the volume of (cold) water flowing into the detergent dispenser. It consists of an impeller wheel with a magnet core and a Hall integrated circuit. When the wheel rotates, the magnet emits impulses to the Hall IC.

The water flow is marked by an arrow on the side of the sensor.

## Specifications:

- Voltage: 12 VDC
- Detected flow rate: 0 – 10 liters/minute

**NOTE:** If there's air bubbles in the water, higher flow rates may be detected.

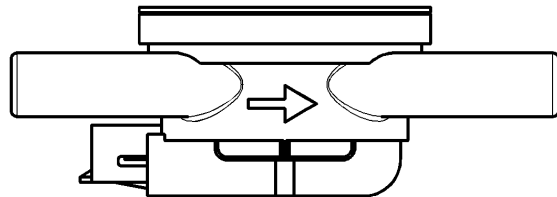
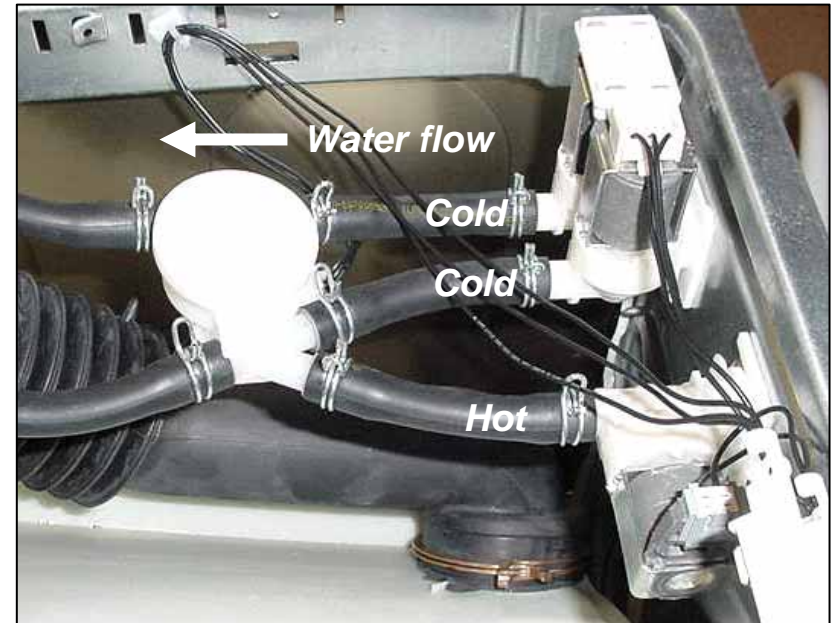

**Water flow arrow**

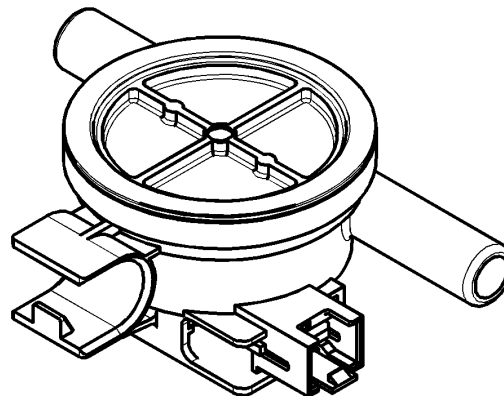

**HINT:** Make sure the water flow arrow points from the water inlet valve to the dispenser.

# WFMC64/84 Service Tips – Mechanical & Analog Pressure Switches

The water level (pressure switch) system consists of a pressure sensor and a pressure switch.

## Pressure Switch

The pressure switch (*brown*) has (3) switching positions:

- Water level < level 1
- Water heating level
- Overflow level

## Pressure Sensor

The pressure sensor (*black*) determines the different water levels in the various wash programs. It is piezo-electric (pressure on it generates a voltage) and generates between 0.5 - 3.5 VDC.

**HINT:** Its not helpful to measure the pressure sensor voltage because its shown on the digital display while the washer is in the test program.

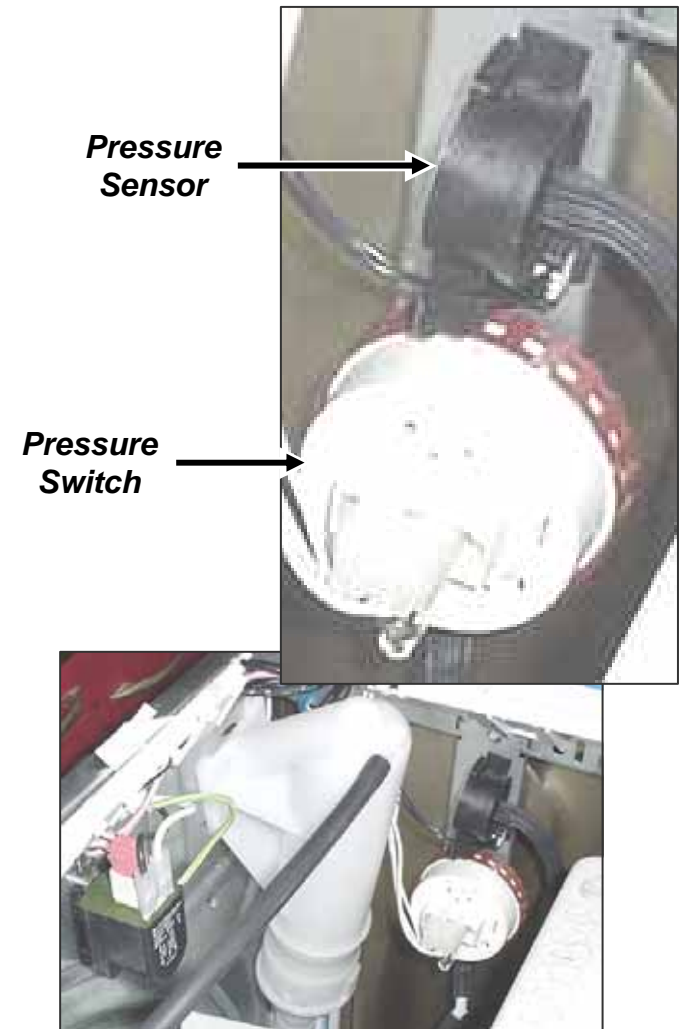

# WFMC Service Tips – Test Program (1A): Starting WFMC32/33/43/53 Test Program

**WFMC32/33/43/53** washer test programs self-diagnose problems, including listing the last **8** fault codes from the control module & the last **16** fault codes from the motor control. The tests are easy to use, speeding up and simplifying diagnosing washer issues.

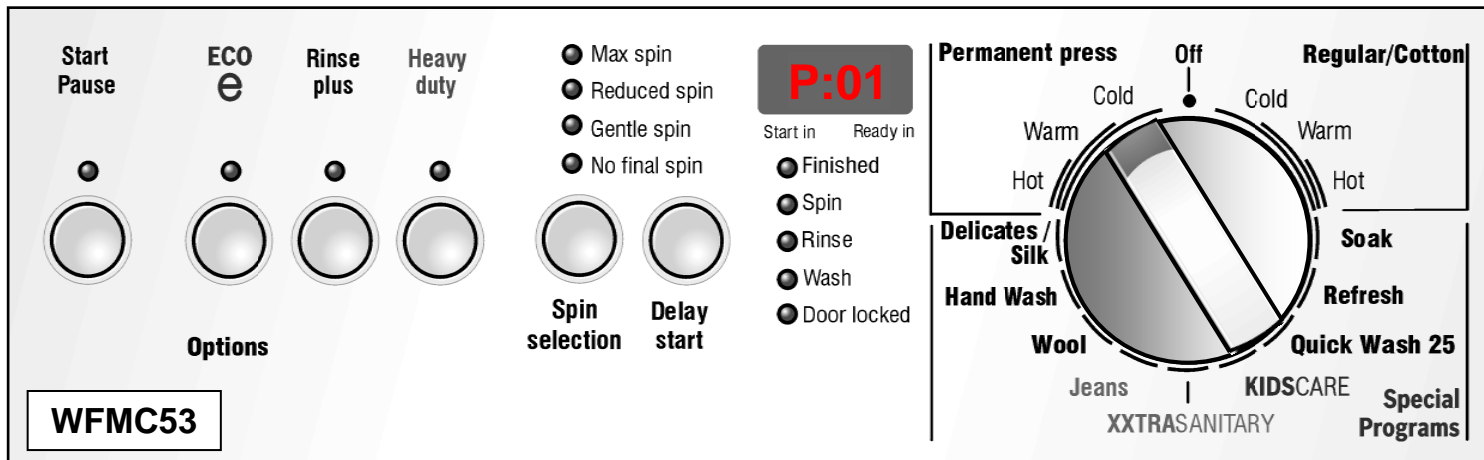

**NOTE:** Door locks for all water fill and drain tests.

**HINT:** If **Start/Pause** light doesn't come on for some tests, door is open. Turn off washer, then close door.

## Entering & using WFMC32/33/43/53 test programs:

- To reset, rotate cycle selector knob to **Off** position.
- To enter test program, push and hold **Spin Selection** and **Delay Start** buttons at the same time, then rotate cycle selector knob **ccw** to **Permanent Press Cold** position. Hold **Spin Selection** and **Delay Start** buttons until **P:01** shows in display.
- To select tests, push **Spin Selection** button (to scroll through tests) until desired test shows in display (**P:01 - P:17**) - **Start/Pause** light will flash.
- To start tests, push **Start/Pause** button while its light is flashing -- light stays lit when test has started. To end tests, push **Spin Selection** button.
- To exit test program, rotate cycle selector knob to **Off** position.



# WFMC Service Tips – Test Program (1B): Starting WFMC64/84 Test Program

**WFMC64/84** washer test programs self-diagnose problems, including listing the last **8** fault codes from the control module & the last **16** fault codes from the motor control. The tests are easy to use, speeding up and simplifying diagnosing washer issues.

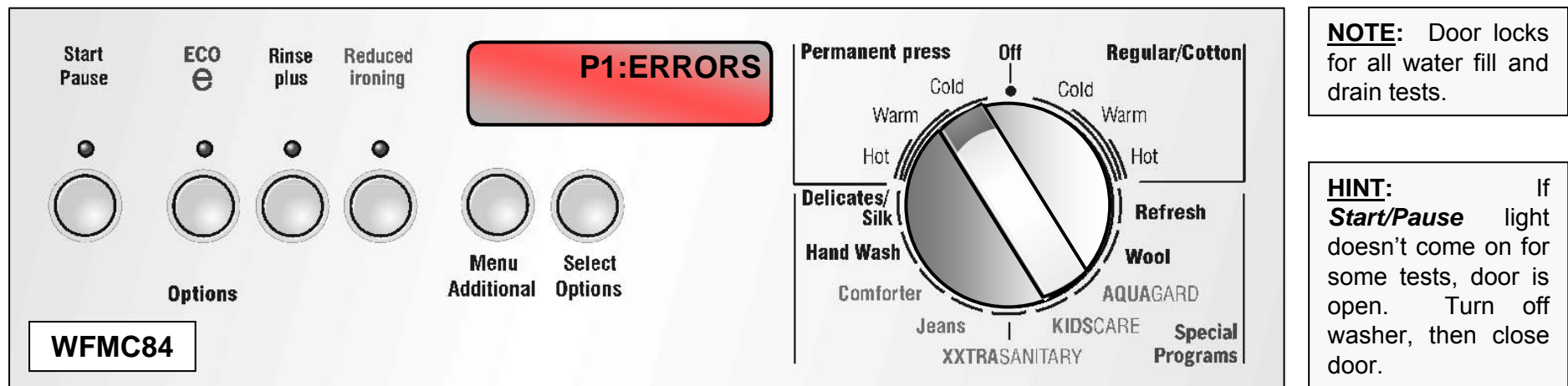

## Entering & using WFMC64/84 test programs:

- To reset, rotate *cycle selector knob* to **Off** position.
- To enter test program, push and hold **Menu** and **Select** buttons at the same time, then rotate *cycle selector knob* **ccw** to **Permanent Press Cold** position. Hold **Menu** and **Select** buttons until **P1: Errors** shows in display.
- To select tests, push **Menu** button (to scroll through tests) until desired test shows in display (**P1 - P17**) - **Start/Pause** light will flash.
- To start tests, push **Start/Pause** button while its light is flashing -- light stays lit when test has started. To end tests, push **Menu** button.
- To exit test program, rotate *cycle selector knob* to **Off** position.

# WFMC Service Tips – Test Program (2A): Fault Code Displays

## Viewing fault codes:

- WFMC32/33/53 displays alternate between fault code (e.g. **E:01**) & when fault occurred on in last 8 washes (e.g. **C:00**) – shows **C:00** if fault didn't occur.
- WFMC64/84 displays show fault code & when fault occurred on in last 8 washes (e.g. **0 - Er:01**).

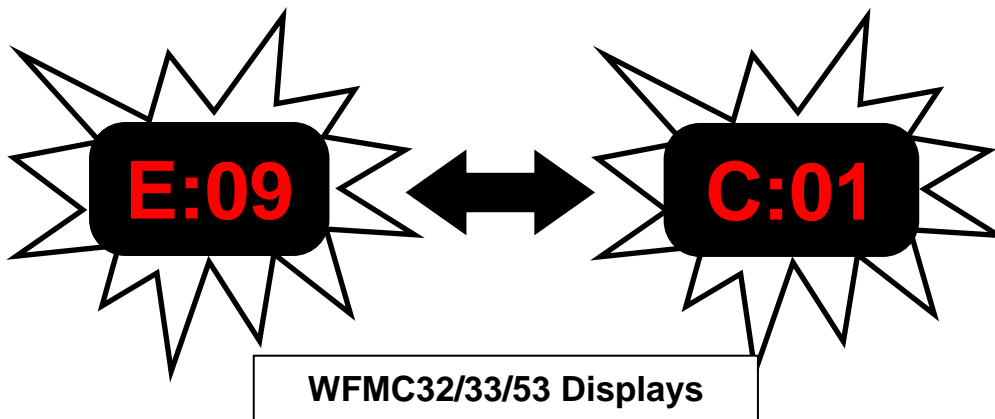

**WFMC32/33/53** fault code displays flash – alternating between fault code (**E:09**) and wash when fault occurred (**C:01**)

TIP: Washers are designed to give a service history, not show only latest fault codes. Since fault codes stored in module or motor control can't be cleared, don't expect fault codes to be reset to "0" when repairs are made.

>START>MENU P1:ERRORS  
1- Er:09

>START>MENU P1:ERRORS  
1- dr:06

**WFMC64/84 Displays**

**WFMC64/84** displays show fault codes (**Er:09**) and washes when faults occurred (**1**)

After control module fault codes have been shown, displays show motor control fault codes (**dr:06**) and washes when faults occurred (**1**).

NOTE: Some control modules have been replaced since fault codes stored in module or motor control can't be cleared. Modules are operating properly and shouldn't be replaced to clear fault codes.

HINT: If "ERROR" shows on display and washer beeps while in wash mode, check wire harness connections to control module and from sensors (black wires), such as pressure sensor. Loose connections may cause this code.

# WFMC Service Tips – Test Program (2B): Module Fault Codes (Test 1)

Test **P1:ERRORS / P:01** (Viewing control module fault codes) -- Start & end test **P1** (WFMC64/84) / (**P:01**) (WFMC32/33/53) by pushing **Start/Pause** button. Scroll through all fault codes by pushing **Spin Selection** (WFMC32/33/53) or **Menu** (WFMC64/84) buttons.

- WFMC32/33/53 displays alternate between fault code (e.g. **E:01**) & when fault occurred on in last 8 washes (e.g. **C:00**) – shows **C:00** if fault didn't occur.
- WFMC64/84 displays show fault code & when fault occurred in last 8 washes (e.g. **0 - Er:01**).

**Last 8 fault codes are stored & displayed!**

**HINT:** # of faults reads "0" for faults which didn't occur. Scroll thru all faults and look at # of faults to see which faults occurred.

<b>WFMC32/ WFXD52 Displays</b>	<b>WFMC64/ WFXD84 Displays</b>	<b>Test #</b>	<b>Problem</b>	<b>Possible Cause(s)</b>
<b>E:01</b>	<b>Er:01</b>	<b>washing</b>	Door open	Door lock not engaged
	<b>Er:02</b>	<b>washing</b>	Door lock can't be locked	Jammed lock or bad wire harness
<b>E:03</b>	<b>Er:03</b>	<b>washing</b>	Door lock can't be unlocked	Jammed lock or bad wire harness
<b>E:04</b>	<b>Er:04</b>	<b>washing</b>	Door control broken	Faulty Triac/control module or oversudsing (washer locks, thinking it has overfilled)
<b>E:05</b>	<b>Er:05</b>	<b>P:16</b>	NTC open-circuited	Faulty NTC or bad wire harness
<b>E:06</b>	<b>Er:06</b>	<b>P:16</b>	NTC shorted	Faulty NTC or bad wire harness
<b>E:07</b>	<b>Er:07</b>	<b>P:16</b>	Unexpected heating (heater on at wrong time)	Faulty heater or stuck heater relay
<b>E:08</b>	<b>Er:08</b>	<b>P:16</b>	Heater doesn't shut off	Faulty heater or stuck heater relay
<b>E:09</b>	<b>Er:09</b>	<b>P:4</b>	Communication lost to motor	Faulty wire harness
----	<b>Er:10</b>	<b>P:11</b>	Flow meter gives wrong values	Faulty flow meter or wire harness
----	<b>Er:11</b>	<b>P:8/9/13</b>	No water flow (within 6 minutes)	Faulty inlet valve, wire harness, hose
<b>E:12</b>	<b>Er:12</b>	<b>P:8/9/13</b>	Water supply time exceeded	Faulty inlet valve, wire harness, hose
<b>E:13</b>	<b>Er:13</b>	<b>P:15</b>	Drain pump time exceeded	Faulty drain pump, wire harness, hose
<b>E:14</b>	<b>Er:14</b>	<b>P:9</b>	Overflow level exceeded	Faulty/blocked pump, hose, inlet valve
----	<b>Er:15</b>	<b>P:8</b>	Pressure sensor gives failure voltage level	Faulty pressure sensor, wire harness
----	<b>Er:16</b>	<b>P:8</b>	Can't calibrate pressure sensor	Faulty pressure sensor, wire harness
<b>E:20</b>	<b>Er:20</b>	<b>P:4</b>	Spinning aborted due to unbalanced load	Unbalanced load or faulty wire harness
<b>E:21</b>	<b>Er:21</b>		Excessive foam	Wrong or too much detergent used
<b>E:22</b>	<b>Er:22</b>	<b>washing</b>	Frequency synchronization failed	Faulty control module
<b>E:24</b>	<b>Er:24</b>	<b>P:4</b>	Motor power relay failed	Faulty control module

NOTE: Fault codes stored in module can't be cleared.  
702\_58300000133618\_ara\_en\_a

Rev 0 (1/17/08)



# WFMC Service Tips – Test Program (2C): Motor Control

## Fault Codes (Test 1)

Test **P1:ERRORS / P:01** (Viewing motor control fault codes) -- Start & end test **P1** by pushing **Start/Pause** button. Scroll through all fault codes by pushing **Spin Selection** (WFMC32/33/53) or **Menu** (WFMC64/84) buttons. If motor fault codes can't be accessed, no faults occurred – control module fault codes will show repeatedly.

- WFMC32/33/53 displays alternates between fault code (e.g. **d:01**) & when fault occurred on in last 16 washes (e.g. **C:00**) – shows **C:00** if fault didn't occur.
- WFMC64/84 displays show fault code & when fault occurred in last 16 washes (e.g. **0 - dr:01**).

**Last 16 fault codes are stored & displayed!**

**HINT:** Motor fault codes don't show if none occurred -- # of faults reads "0" for faults which didn't occur. Scroll thru all faults and look at # of faults to see which faults occurred.

<b>WFMC32/WFXD52</b> <i>Displays</i>	<b>WFMC64/WFXD84</b> <i>Displays</i>	<i>Test #</i>	<i>Problem</i>	<i>Possible Cause(s)</i>
<b>d:01</b>	<b>dr:01</b>	<b>P:04</b>	Motor control short circuited.	Faulty motor control.
<b>d:02</b>	<b>dr:02</b>	<b>P:04</b>	Motor control interruption.	Faulty motor control.
<b>d:03</b>	<b>dr:03</b>	<b>P:04</b>	Damaged motor control temperature sensor.	Faulty temperature sensor.
<b>d:06</b>	<b>dr:06</b>	<b>P:04</b>	NTC relay failure.	NTC too hot or relay stuck closed.
<b>d:07</b>	<b>dr:07</b>	<b>P:04</b>	Motor control (inverter) failed or motor shorted.	Faulty motor control or motor.
<b>d:08</b>	<b>dr:08</b>	<b>P:04</b>	Motor speed sensor failed.	Faulty speed sensor or wire harness.
<b>d:09</b>	<b>dr:09</b>	<b>P:04</b>	Voltage too high.	Faulty motor control.
<b>d:10</b>	<b>dr:10</b>	<b>P:04</b>	Power limiter switch off.	Motor overloaded or binding.
<b>d:11</b>	<b>dr:11</b>	<b>P:04</b>	Voltage too low.	Faulty motor control.
<b>d:12</b>	<b>dr:12</b>	<b>P:04</b>	Motor control high current switch off.	Motor overloaded or binding.
<b>d:13</b>	<b>dr:13</b>	<b>P:04</b>	Motor control high temperature switch off.	Motor overloaded or binding.
<b>d:14</b>	<b>dr:14</b>	<b>P:04</b>	Motor control high temperature warning.	Motor overloaded or binding.
<b>d:15</b>	<b>dr:15</b>	<b>P:04</b>	Power limiter warning.	Motor overloaded or binding.
<b>d:16</b>	<b>dr:16</b>	<b>P:04</b>	Motor high temperature switch off.	Motor overloaded or binding.
<b>d:17</b>	<b>dr:17</b>	<b>P:04</b>	Motor high temperature warning.	Motor overloaded or binding.
<b>d:18</b>	<b>dr:18</b>	<b>P:04</b>	Peak voltage too high.	Faulty motor control.

NOTE: Fault codes stored in motor control module can be cleared by pressing the **Start/Pause** button. **HINT:** If no motor fault codes occurred, fault codes can't be scrolled to – module fault codes will show up repeatedly.

# WFMC Service Tips – Troubleshooting (1)

<i>Symptom</i>	<i>Problem</i>	<i>Solution</i>
Washer won't start.	<ul style="list-style-type: none"> <li>❑ Electricity is disconnected or has been turned off.</li> <li>❑ Cycle selector knob or control module has failed.</li> </ul>	<ul style="list-style-type: none"> <li>❑ Make sure washer is connected to an appropriate 120V, 60 Hz circuit (according to local codes). Turn on electricity.</li> <li>❑ Control module has onboard cycle selector knob. Check voltage output to water inlet valves and drum motor (when they're energized). If no voltage, replace faulty control module.</li> </ul>
Washer won't fill.	<ul style="list-style-type: none"> <li>❑ Water supply turned off.</li> <li>❑ Water inlet hose filters (strainers) blocked.</li> <li>❑ Water pressure too low.</li> <li>❑ Control module has failed.</li> <li>❑ Water inlet valve(s) has failed.</li> </ul>	<ul style="list-style-type: none"> <li>❑ Turn on water supply.</li> <li>❑ Check water inlet hose filters. Clean if dirty. Replace filters if damaged.</li> <li>❑ Check incoming water pressure.</li> <li>❑ Check voltage output to water inlet valves (when they're energized). If no voltage, replace faulty control module.</li> <li>❑ Measure resistance of water inlet valves (~ 2.7 – 4.5 kΩ). Replace inlet valve(s), if faulty.</li> </ul>
Washer won't drain.	<ul style="list-style-type: none"> <li>❑ Drain pump or pump motor protector has failed.</li> <li>❑ Control module has failed.</li> </ul>	<ul style="list-style-type: none"> <li>❑ Disconnect drain pump and measure resistance at connector (~ 140 – 200 Ω). Replace drain pump if faulty.</li> <li>❑ Check voltage output to drain pump when it's energized. If no voltage, replace faulty control module.</li> </ul>

**WARNING!** Unplug washer before starting any repairs.

**HINT:** The washer test program diagnoses problems quickly and thoroughly where resistance measurements usually aren't needed.

# WFMC Service Tips – Troubleshooting (2)

<i>Symptom</i>	<i>Problem</i>	<i>Solution</i>
Drum won't rotate.	<ul style="list-style-type: none"> <li>❑ Drum rear bearing has failed.</li> <li>❑ Motor control has failed.</li> <li>❑ Drum drive motor has failed.</li> </ul>	<ul style="list-style-type: none"> <li>❑ Check how drum rotates. If drum wobbles or won't move, replace outer tub (containing faulty rear bearings).</li> <li>❑ ① Check voltage at motor connectors when motor is energized. If low or no voltage, replace faulty motor control. ② If voltage ~ 120V, check motor resistance (when washer de-energized). If motor is OK, replace faulty motor control.</li> <li>❑ Check voltage at motor connectors when motor is energized. If ~ 120V, check motor resistance (when washer de-energized). If motor faulty, replace faulty drum motor.</li> </ul>
Washer won't heat.	<ul style="list-style-type: none"> <li>❑ Heater has failed.</li> <li>❑ NTC has failed.</li> <li>❑ Heater is covered with scale.</li> <li>❑ Voltage too low.</li> <li>❑ Control module has failed.</li> </ul>	<ul style="list-style-type: none"> <li>❑ Disconnect heater and measure resistance at terminals (~ 13.7 – 15.2 <math>\Omega</math>). Replace heater if faulty.</li> <li>❑ Disconnect NTC and measure resistance at terminals (~ 22.8 – 27.4 k <math>\Omega</math> @ 20°C (68°F)). Replace NTC if faulty.</li> <li>❑ If possible, remove &amp; clean heater. If not, replace it.</li> <li>❑ Have an electrician check the house wiring and the wiring to the washer to make sure it is 120 volts.</li> <li>❑ Check voltage output to drain pump when it's energized. If no voltage, replace faulty control module.</li> </ul>

**WARNING!** Unplug washer before starting any repairs.

**HINT:** The washer test program diagnoses problems quickly and thoroughly where resistance measurements usually aren't needed.



# WFMC Service Tips – Troubleshooting (3)

<i>Symptom</i>	<i>Problem</i>	<i>Solution</i>
Washer overheats.	<ul style="list-style-type: none"> <li>❑ Control module has failed.</li> <li>❑ NTC failed.</li> </ul>	<ul style="list-style-type: none"> <li>❑ Check voltage to heater. If voltage is present when heater shouldn't be on, replace faulty control module.</li> <li>❑ Disconnect NTC and measure resistance at terminals (~ 22.8 – 27.4 kΩ @ 20°C (68°F)). Replace NTC if faulty.</li> </ul>
Door won't lock.	<ul style="list-style-type: none"> <li>❑ Door isn't closed properly.</li> <li>❑ Door latch is broken.</li> <li>❑ Door lock has failed.</li> </ul>	<ul style="list-style-type: none"> <li>❑ Close door securely. If door won't latch, check door latch and door hinge alignment.</li> <li>❑ Replace broken door latch.</li> <li>❑ Measure resistance of door lock mechanism (~ 159 - 211 Ω). Replace faulty door lock mechanism.</li> </ul>

**WARNING!** Unplug washer before starting any repairs.

**HINT:** The washer test program diagnoses problems quickly and thoroughly where resistance measurements usually aren't needed.



# WFMC Service Tips – Oversudsing & Suds Lock

If washers time out and shut off without an end of cycle signal (and without going through the spin cycle), the washer has experienced **suds lock**, a possible occurrence with all front loader washers (regardless of manufacturer).

- **Suds lock:** *Suds lock* comes from suds (airy foam) interfering with water level sensors (pressure switches). Electronic controls are fooled into thinking water hasn't been removed fully, so washers won't go into spin cycles. Drain pumps can also get air locks in them.
- **Cause:** *Suds lock & oversudsing* come from using too much detergent, using the wrong kind of detergent (not HE) or overloading washers (trapping suds in clothes).
- **Solution:** Where *oversudsing* has occurred, have the washer cleaned out every 6 months by running it without clothing using a hot water wash (with cold water rinse) & ½ gallon of white vinegar. When suds have overflowed, run a cold water rinse using 1 gallon of white vinegar. **NOTE:** Don't use vinegar routinely to avoid possible damage to washer parts.
- **Customer education:** Educate customer on type (HE) and amount of detergent to use. To remove suds from clothes, have customer rewash clothes with liquid fabric softener, ½ recommended amount of detergent & a cold water rinse.

**TIP:** Fault code **E:04/Er:04** can occur during oversudsing if pressure switch locks door, thinking washer has overfilled.



**TIP:** Because front loader washers wash the same amount of clothes more efficiently with much less water than top loader washers, high efficiency (HE) detergent specially formulated for front loader washers is needed. Have customers follow detergent directions and not expect to see suds.

**TIP:** Powdered detergent works better than liquid detergents (due to more surfactants in liquid detergents).

**NOTE:** Where possible, handle such calls over the phone without making service calls.

# ?? Washer Service Pop Quiz ??

- 1. Any laundry detergent can be used with front loader washers (T/F).**
- 2. The washer test program eliminates the need for diagnosing (T/F).**
- 3. Washer doors can be reversed from left to right hinge (T/F).**
- 4. Drive motors haven't changed and can be used with any washer or motor control (T/F).**
- 5. All washer components are accessible from the rear (T/F).**
- 6. Changing washer feet will solve any vibration problem (T/F).**
- 7. Front and rear tubs can be interchanged, regardless of color (T/F).**
- 8. If the washer stops for a failure, the door can't be opened and laundry can't be removed (T/F).**
- 9. If the motor won't run, is the problem with the washer control, motor control, motor or motor wire harness?**
- 10. Rear bearings can be changed in the rear tub (T/F).**



# ?? Washer Service Pop Quiz ?? Answers

1. Any laundry detergent can be used with front loader washers (T/F). **HE** **F**
2. The washer test program eliminates the need for diagnosing (T/F). **Almost!** **F**
3. Washer doors can be reversed from left to right hinge (T/F). **F**
4. Drive motors haven't changed and can be used with any washer or motor control (T/F). **F**
5. All washer components are accessible from the rear (T/F). **Controls/dispenser** **F**
6. Changing washer feet will solve any vibration problem (T/F). **F**
7. Front and rear tubs can be interchanged, regardless of color (T/F). **F**
8. If the washer stops for a failure, the door can't be opened and laundry can't be removed (T/F). **Manual door lock release** **F**
9. If the motor won't run, is the problem with the washer control, motor control, motor or motor wire harness? **Could be any – must check**
10. Rear bearings can be changed in the rear tub (T/F). **Change rear tub** **F**