



TECHNICAL SERVICE GUIDE

GE Profile™ Prodigy™ Washer Electronic Control



MODEL SERIES:

WASE4220
WBBE3300
WBSE2090
WBXE2070
WCSE3100
WCSE4230
WJSE3110
WNSE4200
WPSE3120
WPSE4200
WPSE4270
WSSE4220

Table of Contents

Electronic Control Description	2
Control Panels	3-4
Control replacement models	4
UC Control Settings	5-6
Washer Features	6
Service PC Board	7
Basic Washer Operation	8-9
Diagnostics Mode	10
Indicator Lights and Codes	11-12
Troubleshooting Flowchart	13
Schematic	14
Exploded View (sample)	15
Parts List (sample)	16

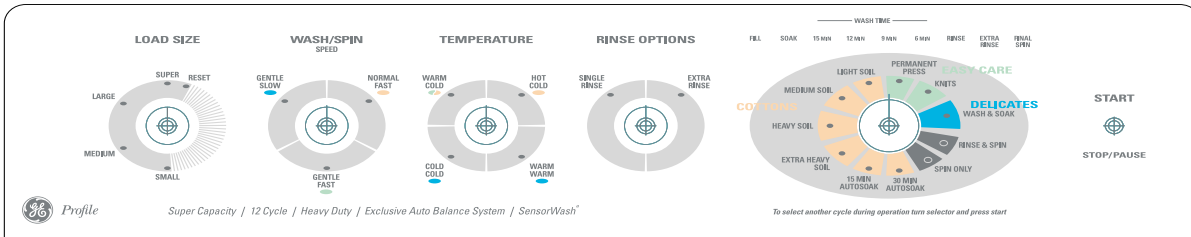

Note LED's which provide cycle information to user, and diagnostics information to servicer

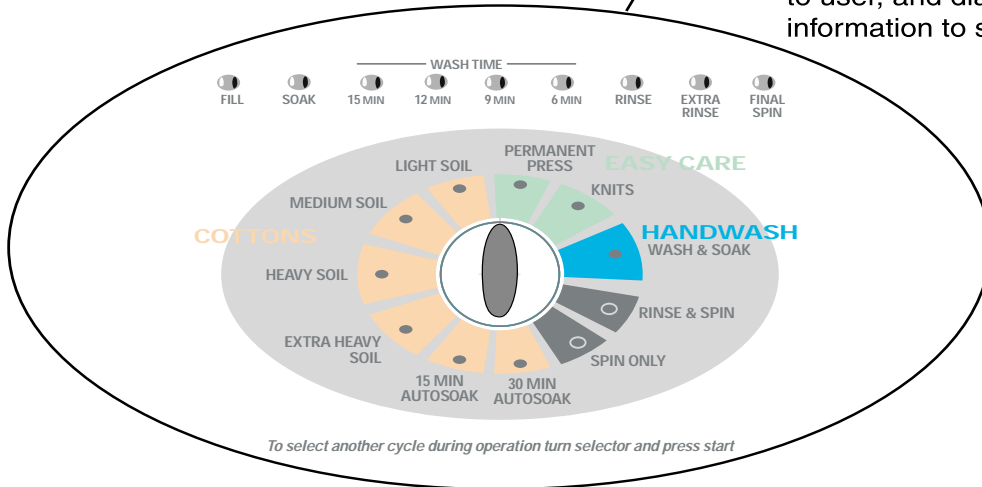

Now GE answers the need for **true clothes care** with the Precision Care Washer, the first in a series of remarkable **new electronic clothes washer and dryer** systems. Unlike other washers that change only the length of time spent scrubbing clothes, the new GE washer's unique programmed cycles change wash time, **agitation speed and soak time**. **For the servicer the LED's provide diagnostics indicators for most component level parts, the control knobs appear to the user as the same switch type controls we have used on previous front service washer. However, it is operated by a PC Board Controller, and a two wire pressure switch that sends a signal to the board for water level control.**

GE Precision Care Washer is a laundry system versatile enough to truly clean almost everything you own from heavy cottons to hand washables to dry cleanables. **Specialized settings** take care of a variety of fabrics. The GE Precision Care Washer has been designed to clean and care for delicates to heavy cottons. And the washer is flexible enough to **handle different** size loads, from a week's worth of the family's bed linens to a single sweater.

GE's Precision Care washer is a completely new design, inside and out. The result of a four-year development program, the Precision Care system was put through rigorous GE Six Sigma tests for quality and durability. In addition, the GE Clothes Care Institute was established especially for this long-term project. Staffed by accredited textile experts, the Institute is dedicated to developing washing and drying methods that help prolong the "life" of fabric fibers.

The GE Precision Washer is offered in the Profile™ and Profile Performance Series™ product lines.

Model WASE4220

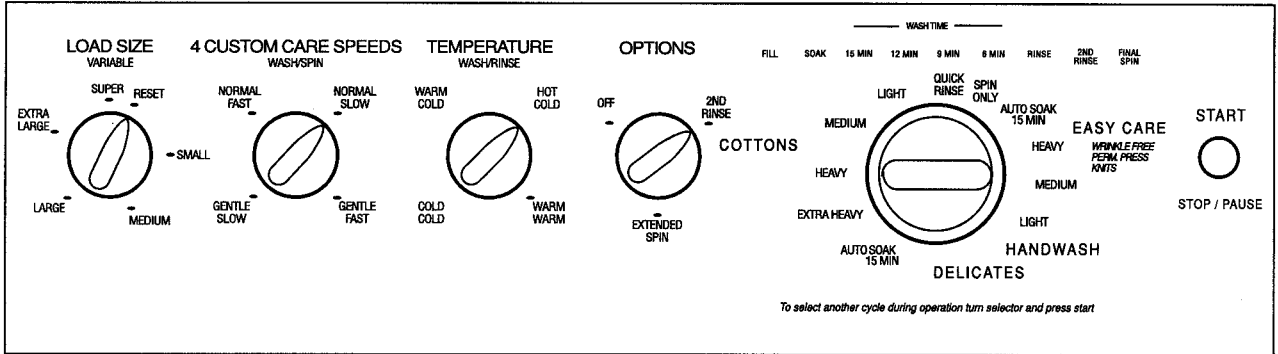

Model WNSE4200

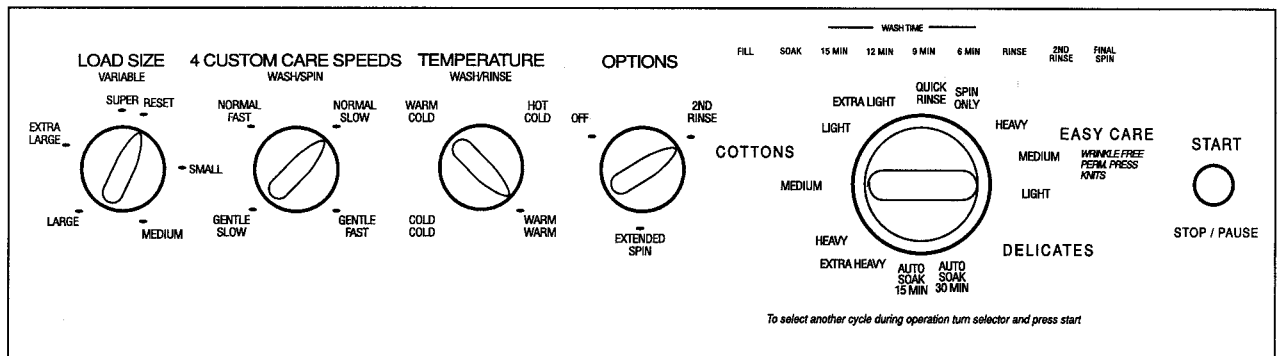

Model WPSE4200

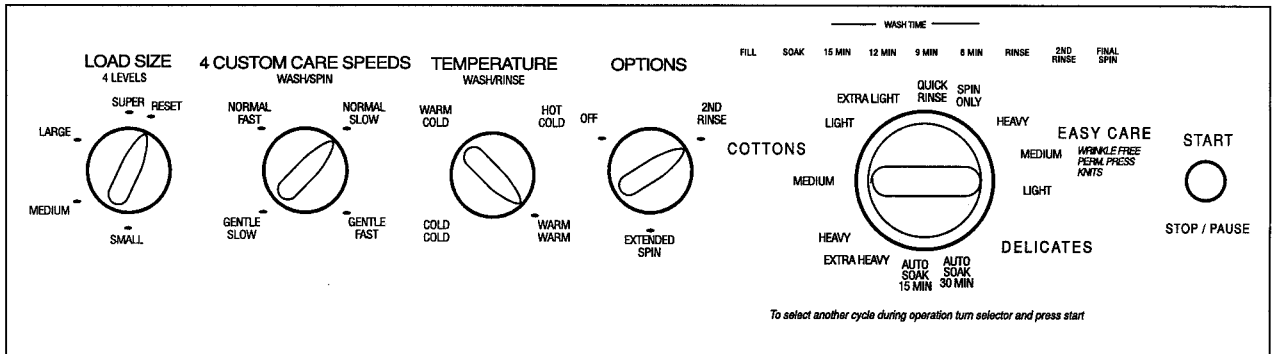

Model WPSE4270

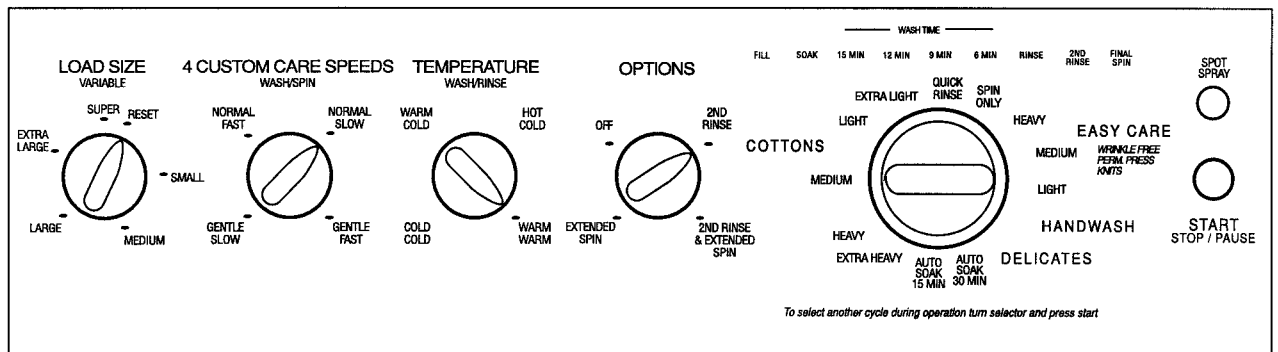

Model WPSE5290

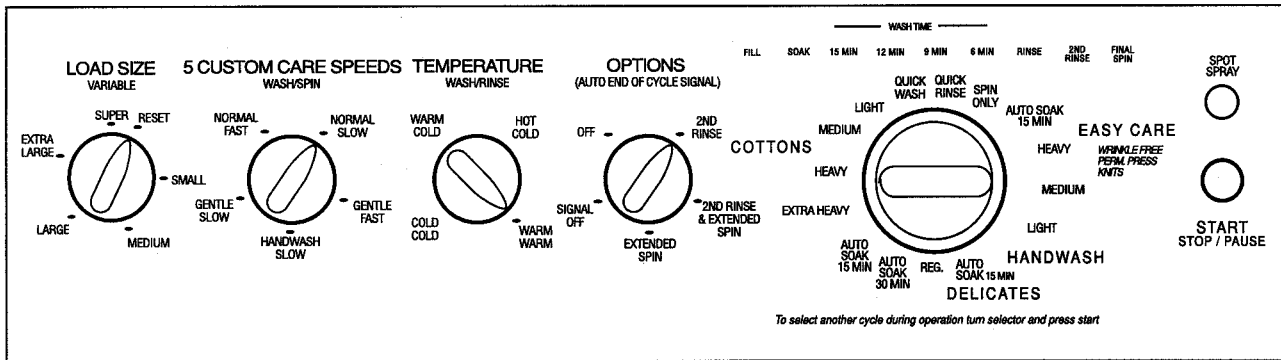

Model WSSE4220

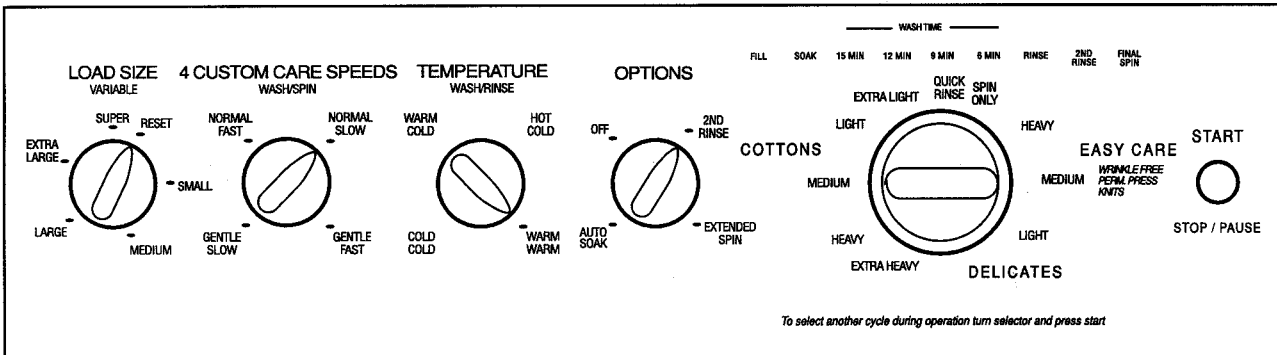

The electronic washer control replaces the current electromechanical timer and rotary selection switches. This should improve the reliability of the controls throughout the life of the washer.

Primary differences from previous controls is that the cycle selection knob **DOES NOT SELF ADVANCE**, the units feature LED lights for cycle status, and have a Start button. The LED lights are also used as a service technicians' diagnostics tool.

Although the model change is called **L2**, it consist of four variations. The service PC Control is **WH12X10106**, and will require the insertion of correct knobs and detents for the model being serviced. Instructions are shipped with the kit.

- L2B-Two knob models*
- L2C-Three knob models*
- (•L2D-Four knob models)(**Note: this is a separate part**)
- ***L2S-Field service control to replace L2C or L2B.**

Number of knobs doesn't include pressure switch.

Another important change is that the pressure switch now gets its' signal from the control board, and does not carry line current. It is now a two wire connection as shown on the mini manual in the back of this service guide.

About the control settings.

1 Load Size

The water level should just cover the clothes. Adjust the load size accordingly. Loosely load clothes no higher than the top row of holes in the washer tub.

2 Custom Care Wash/Spin Speeds

The agitator moves clothes around for a cleaner wash: the basket spins later in the cycle to release water from the load. The Wash/Spin Speed dial set the speed of both the agitator and the basket

With Normal wash speed, the agitator moves faster. Use for cottons, denims and play clothes. With Gentle wash speed, the agitator moves slower. Use for delicate and knit items.

The Fast spin speed is for durable items. The slow spin speed is for delicate items like sweaters and lingerie. When using the Slow Spin speed, clothes will be less dry than when using Fast spin speed.

The Handwash wash speed is for items labeled handwashable.

3 Temperature

Select the water temperature for the wash and rinse cycles. Always follow fabric manufacturers care label or instructions when laundering. Follow the water temperature guide on the washer lid.

4 Wash Cycle

The wash cycle controls the length of the washing process. When choosing the cycle, the Cycle Selector knob can be pointed anywhere within the colored box. The knob can be turned in either direction. Turning the Cycle Selector knob after starting a cycle will stop the washer and rest the cycle to the new selection. Press START to begin the new cycle selection.

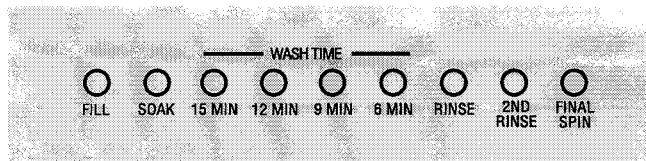

The Cycle indicator Lights show what stage the washer is in. The wash time is the length of the wash agitation. The **6 MIN** light will remain lit during drain and spin. When the Selector knob is set to a new cycle the Indicator Lights will flash momentarily, showing what stages the cycle will go through.

The chart below will help you match the wash cycle setting with your clothing.

COTTONS For heavy to lightly soiled cottons, household linens, work and play clothes.

EASY CARE For wrinkle-free and permanent press items, and knits.

HANDWASH For lingerie and items labeled handwashable with light soils. Provides periods of agitation and soak during wash and rinse.

DELICATES For lingerie and special-care fabrics with light to normal soil.

EXTRA HEAVY For heavily soiled and heavy-duty fabrics. This cycle provides a longer agitation.

15 MIN/30 MIN AUTO SOAK For heavily soiled clothes. Begins with a brief agitation, soaks for a specified period of time, then moves through the rest of the cycle automatically.

5 START

Press START to begin the cycle. Pressing START again or raising the lid will PAUSE the cycle and the CYCLE indicator light will blink.

About washer features.

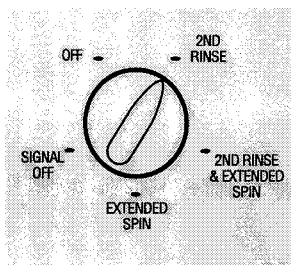

(appearance and features may vary)

2nd Rinse Option (on some models)

When you use extra detergent or bleach to clean heavily soiled clothes, you may want to use the 2nd Rinse option. It provides a second deep cold rinse.

Extended Spin Option (on some models)

Use this option to extract more water from your clothes. Clothes will be drier when this option is selected.

Signal Off Option (on some models)

Some models have a signal that will sound at the end of the cycle. Use this option to turn off the signal.

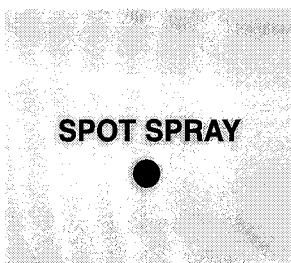

Spot Spray (on some models)

When you open the washer lid and press SPOT SPRAY button, you will see a short stream of cold water.

- 1 Open the washer lid.
- 2 Press the **SPOT SPRAY** button. (You will see a short stream of water.)
- 3 Dampen your soiled garment with the **SPOT SPRAY** option and rub your favorite pretreatment product into soiled area.

NOTE: The **SPOT SPRAY** option will not work if

- the washer lid is down
 - the washer tub is filling
 - the water has already reached the level you selected.
-

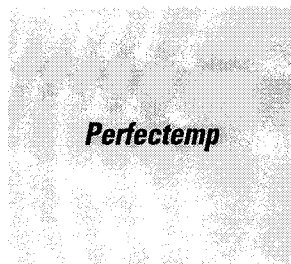

Perfectemp

Perfectemp senses the incoming water temperature and adjusts the fill water to obtain a more precise temperature range for all three wash temperatures. You may select cold, warm or hot. For example, in a Cold Wash selection, some warm water may be added to reach a temperature needed to better dissolve detergents. Often, detergents are not completely dissolved in very cold water, especially in cooler climates.

NOTE: **Perfectemp** will not adjust the fill on **WARM WASH** unless the washer lid is closed. **Be sure to start the washer after the lid is closed.**

TO REMOVE PC BOARD:

1. Remove 4 screws from top of backslash as shown.
2. Remove all control knobs by gently pulling them off of switch shaft.
3. Remove harness connectors, and Model selector harness plug. Save plug to reinstall in new PC Board. See plug location and picture this page.

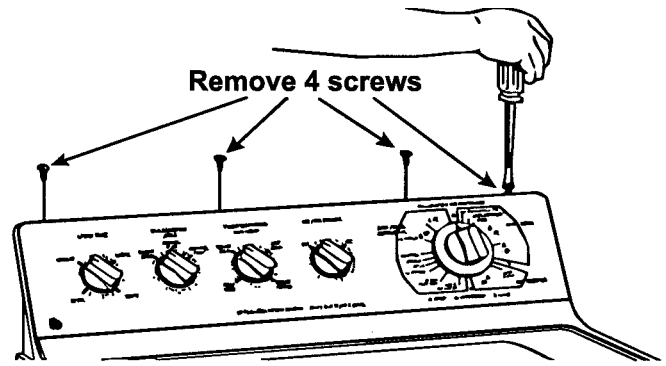

NOTE: It is **CRITICAL** that you retain and re-install the original **MODEL SELECTOR HARNESS PLUG**, when reinstalling the new PC Board. This plug signals the board as to model number, features etc.

4. Remove 4 to 6 1/4" hex screws (depends on model being serviced) from control board as shown.
5. Remove pressure switch wiring from board, and then carefully lift out PC Board.

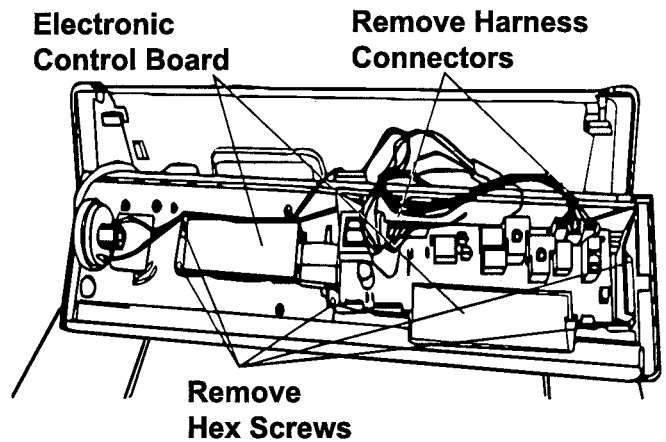

TO REINSTALL PC BOARD:

1. To prevent electrostatic discharge, ground yourself out to washer cabinet, or use ESD wrist band.
2. Align PC Board to backslash mounting plate making sure that they correctly align, and reinstall the 4 to 6 1/4" hex screws. Make sure LED's are aligned and showing through control panel when reassembled.
3. Reconnect pressure switch wiring.
4. Insert **MODEL SELECTOR HARNESS PLUG** that you retained from original PC Board.
5. Reinstall harness connectors.
6. Reinstall backslash to back panel with 4 screws.
7. Reinstall control knobs.

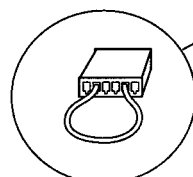
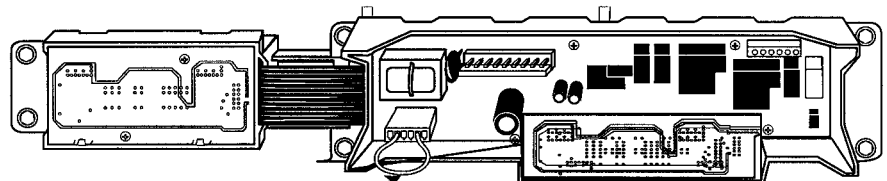

Model Selector Harness Plug

BASIC WASHER OPERATION

The main wash functions are still accomplished through a single or two speed motor, hot and cold-water valves, and a pump. The components are controlled by the electronic control, pressure switch, and rotary or push button (high end) selector switches.

Basic specifications for the motor, pump and water valves are:

- FILL:** timed 20 minute maximum
- AGITATION:** 12 minutes
- PUMP OUT:** 3 minutes
- SPIN:** 3 minutes
- RINSE FILL:** timed, 40 minute maximum
- RINSE:** 3 minutes
- PUMP OUT:** 3 minutes
- FINAL SPIN:** 6 minutes

Electrical:

- Motor:** 1/2hp, 10 amps, 70 amps in-rush, 120VAC
 - Pump:** 3.2 amps, 120VAC
 - Water Valves:** 0.1 amps each, 120VAC
- Relays are 12V DC

The lid switch pauses all washer operations excepting water fill, when the lid is raised. The lid switch cuts power to the D.C. relay coil for the motor.

The pressure switch is in series with the AC power line of both water valves. The two wire system for the pressure switch, reads OPEN with water in the tub.

WASHER MODES:

FILL:

Fill mode activates the water valves according to temperature selected. The cycle advances to the next mode as soon as the pressure switch opens (trips). A fail safe system is built into the control to prevent serious flooding due to a failure in the pressure switch system. The fill is timed, and the water valves de-energized after 40 minutes if the pressure switch has not been tripped. At that point the cycle stops and pauses. If the user changes temperature during fill, it occurs immediately at the change. The fill LED light is on in wash and rinse, when the washer is filling.

WASH, RINSE, EXTRA RINSE AGITATION MODES:

Wash, rinse, and extra rinse operate the motor in agitate at the selected wash speed. Relays switch speed, motor direction for spin or agitate, and main power to the motor. When speed is changed and the motor is running, relays go through the turn off sequence, and then turn on at the newly selected speed. During the wash fill, one of four lights will be on, indicating selection, and progresses as the cycle advances. The wash light remains on during pump and spin when the washer is in the rinse cycle. The rinse and extra rinse lights are on during fill, rinse, and pump, while the washer is in the extra rinse cycle.

DRAIN PUMP OUT:

The control board has circuitry that detects through the pump control relay, a measurement of current of the pump motor. That current describes the torque the motor is outputting. That measurement can determine if the pump motor is pumping water, and when it is finished pumping water and is pumping air.

Multiple samples of the current reading are taken by the PCB, and if acceptable allow the cycle to continue to spin. If it didn't meet the proper readings, PCB will continue to sample, up to a period of 3 minutes. If after 3 minutes the PCB doesn't detect a decrease in the pump current, but the pressure switch reset, the spin mode will be started. If during the spin, the pressure switch trips, the PCB will revert back to pump mode for a second 3 minute pump period, and looks for a decrease in current. If that is not successful the PCB will put washer in idle. This could be indicator of a pump motor that is blocked, or a standpipe too high.

IDLE:

The idle mode has no LED's or relays on, the control is waiting for the consumer to touch a keypad or switch.

PAUSE/STOP:

Pause mode occurs when the consumer presses the stop button during the cycle, the lights that were on indicating current cycle blink. If the start button is not pushed in 24 hours, the control initiates drain, and final spin.

POWER OUTAGE:

In the event of a power outage, and the washer is NOT in idle, the cycle status, and modes are saved in EEPROM. When the power resumes, the washer resumes where it left off. (Start button doesn't have to be pressed).

AUTOMATIC TEMPERATURE CONTROL:

The high end models have an Automatic Temperature Control, ATC. It uses a mathematical system to control cold, warm and hot fills by turning the hot and cold water valves on and off during the fill. The formula limits the number of times the valve is cycled to control noise, and wear. ATC in the WARM setting is not allowed, it is allowed when the lid is closed, this prevents the consumer from having rapid temperature changes on their hands in water stream, when the lid is open.

When the ATC is engaged the water temperature in the tub should be maintained within the ranges specified in the table below for the different wash/rinse settings.

TEMPERATURE SETTINGS	TEMP WASH	VALVE REGULATION BEGINS
HOT	125 +/-15°F	>130°F
WARM	95 +/-10°F	<85°F
COLD	70 +/-10°F	>65°F

FILL IN GALLONS:

Low fill is 9 gallons, and the maximum fill is 22 gallons. A 50 ohm thermistor is located in the outlet stream of the water valve. The thermistor is accurate to $\pm 3\%$, and is used to estimate the temperature of the water in the tub.

SPOT:

When the SPOT button is pressed, the cold water valve is turned on for 8 seconds. The button works in pause or run mode only, when the lid is raised and the pressure switch is closed. (not a tub full of water).

L2 DIAGNOSTICS MODE

The new electronics pc board has an on board diagnostics system. To place the washer in the FIELD SERVICE MODE and EXIT the FIELD SERVICE MODE, follow the sequence shown below.

To ENTER Field Service Diagnostics Mode

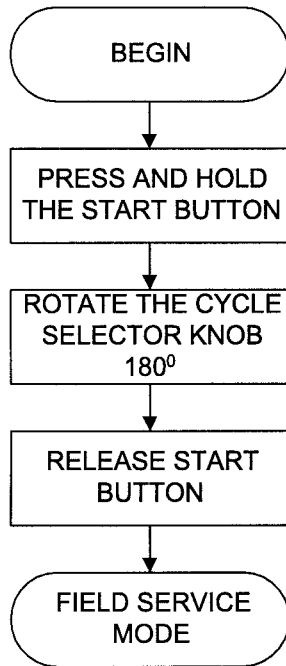

To Exit Field Service Diagnostics Mode

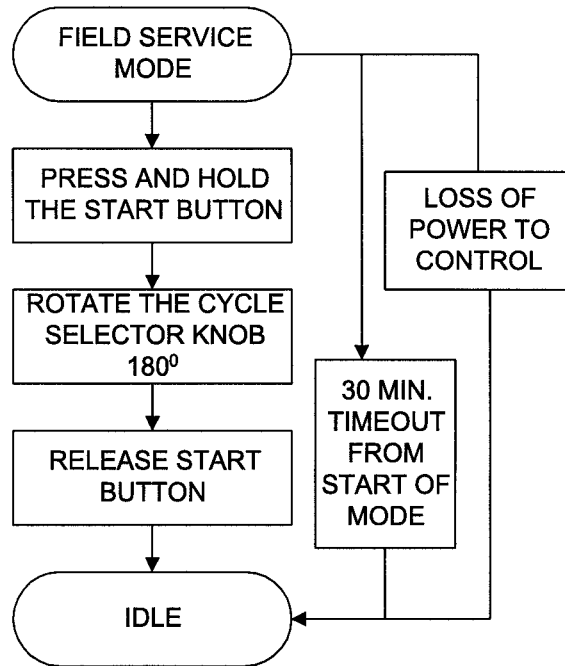

The following steps are performed by turning the cycle selector clockwise to the next click (detent).

1. All LED's light.
2. Model Code Identifier
3. Error Code Identifier (see Problem Diagnostics - Error Codes.)
4. Hot water valve activation.
5. Cold water valve activation.
6. Slow speed dry agitation.
(NOTE: Being in either speed agitation and holding the start button in for 2 seconds will require disable DRY AGITATION and require FILLING WITH WATER before agitation.)
7. Fast speed Dry Agitation.
8. Pump Activation.
9. Spin Activation.

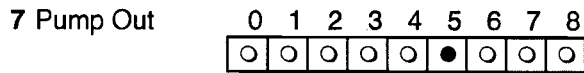

Pump

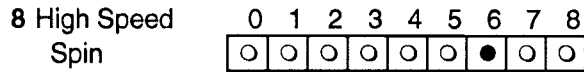

High Speed Spin

To exit the Field Test Mode

- Depress Start button, rotate Cycle Selector Knob 180 degrees, release Start button
- OR -
- Unplug washer

The washer is the current front service model with Electronic control, two-wire pressure switch, and lid switch redesign. Pressure switch is now signalling the PC board and can be checked at pin 4 (wire color wr-white with red tracer), and pin 7 (wire color cx-brown) of the pin connector based on model, check your mini manual for product being serviced.

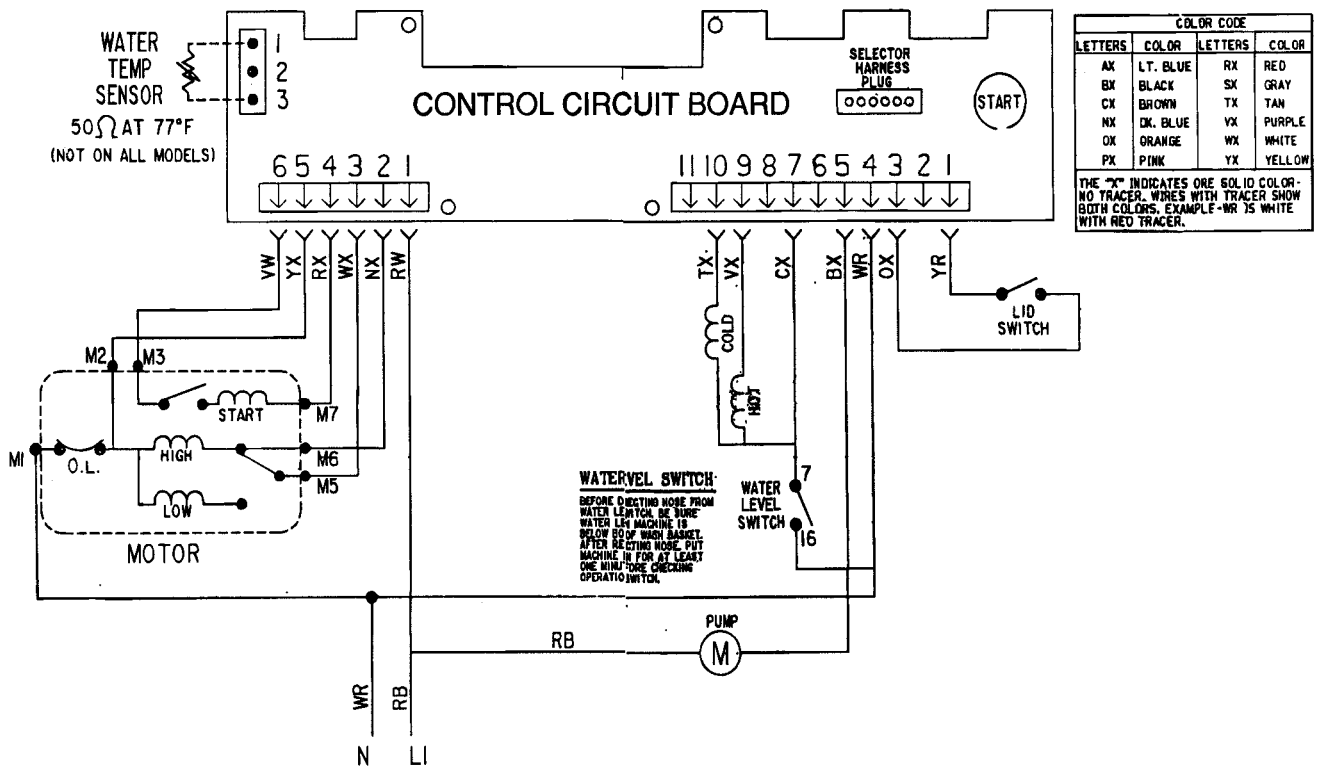

FAULT LIGHT TROUBLESHOOTING

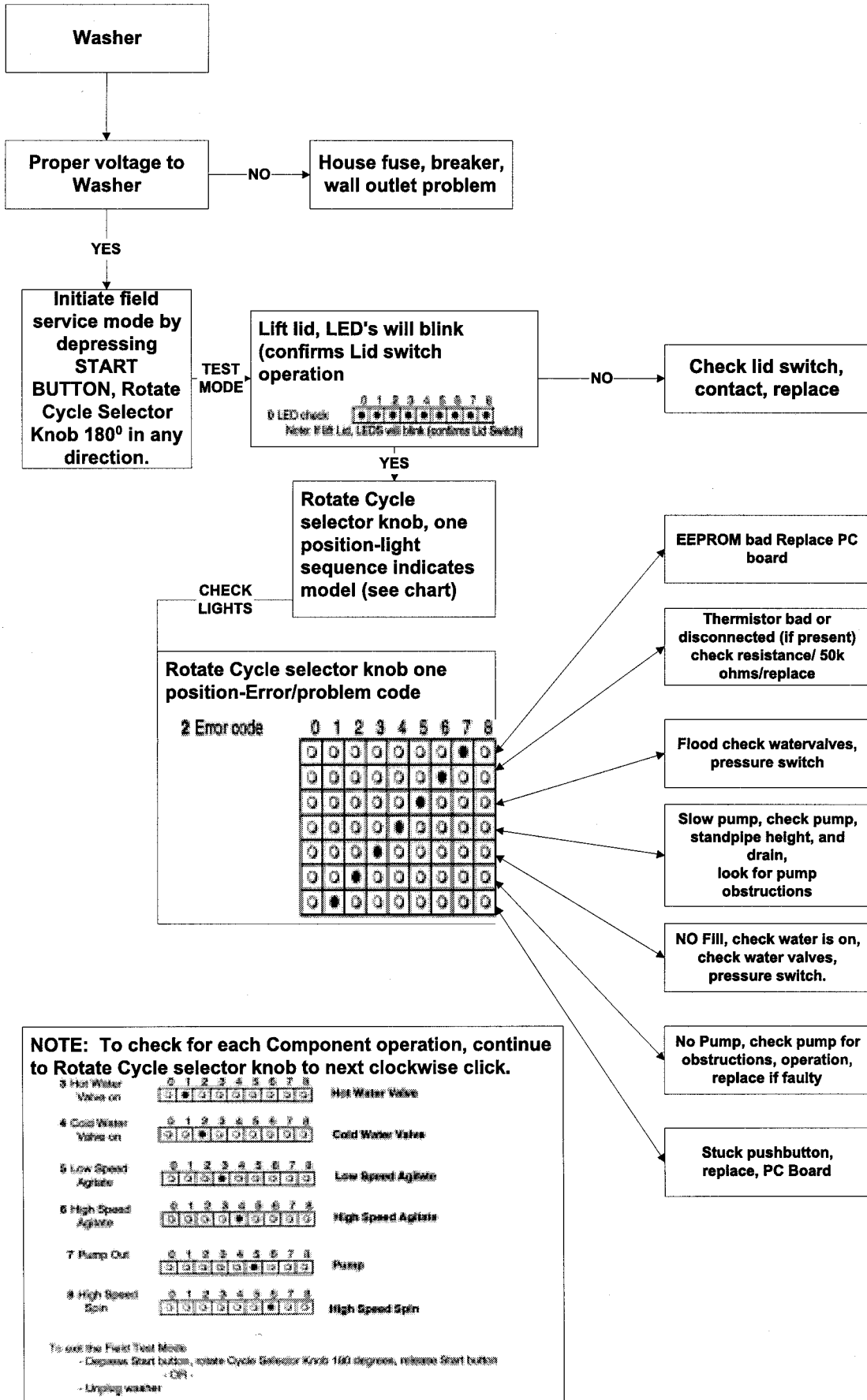

175D2750G151-175D2750G151

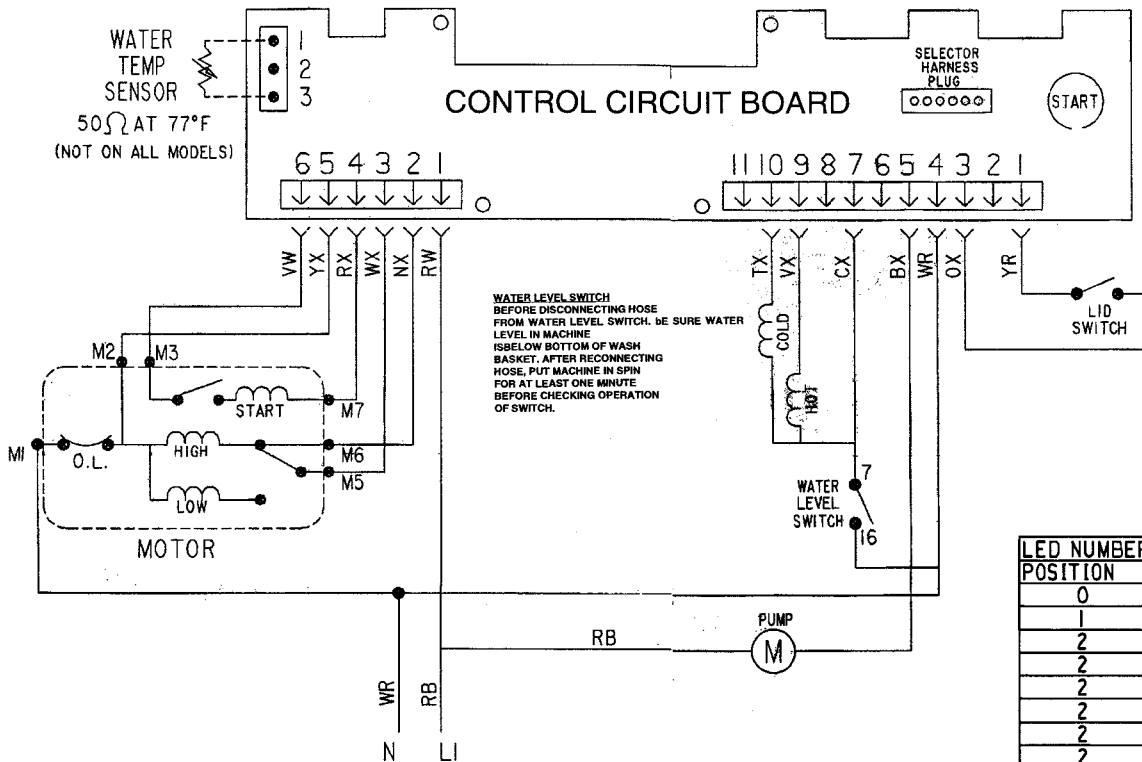

COLOR CODE			
LETTERS	COLOR	LETTERS	COLOR
AX	LT. BLUE	RX	RED
BX	BLACK	SX	GRAY
CX	BROWN	TX	TAN
NX	DK. BLUE	VX	PURPLE
OX	ORANGE	WX	WHITE
PX	PINK	YX	YELLOW

THE "*" INDICATES ONE SOLID COLOR-NO TRACER. WIRES WITH TRACER SHOW BOTH COLORS. EXAMPLE-WR IS WHITE WITH RED TRACER.

WATER LEVEL SWITCH
BEFORE DISCONNECTING HOSE FROM WATER LEVEL SWITCH, BE SURE WATER LEVEL IN MACHINE IS BELOW BOTTOM OF WASH BASKET. AFTER RECONNECTING HOSE, PUT MACHINE IN SPIN FOR AT LEAST ONE MINUTE BEFORE CHECKING OPERATION OF SWITCH.

LED NUMBER	0	1	2	3	4	5	6	7	8	FUNCTION
POSITION	LED	ACTIVE	MODE							LED CHECK
0										LED CHECK
1	0	*	*	*	*	*	*	*	0	MODEL CODE
2	0	0	0	0	0	0	0	1	0	ERROR CODE-EEPROM
2	0	0	0	0	0	0	1	0	0	ERROR CODE-THERMISTOR
2	0	0	0	0	0	1	0	0	0	ERROR CODE-FLOOD
2	0	0	0	0	1	0	0	0	0	ERROR CODE-SLOW PUMP
2	0	0	0	1	0	0	0	0	0	ERROR CODE-NO FILL
2	0	0	1	0	0	0	0	0	0	ERROR CODE-NO PUMP
2	0	1	0	0	0	0	0	0	0	ERROR CODE-PUSHBUTTON
3	0	1	0	0	0	0	0	2	0	HOT WATER VALVE ACTIVE
4	0	0	1	0	0	0	0	2	0	COLD WATER VALVE ACTIVE
5	0	0	0	1	0	0	0	2	0	SLOW AGITATE (DRY) *
6	0	0	0	0	1	0	0	2	0	FAST AGITATE (DRY) *
7	0	0	0	0	0	1	0	2	0	PUMP
8	0	0	0	0	0	0	1	2	0	SPIN

WARNING: TO REDUCE THE RISK OF ELECTRIC SHOCK:
THE POWER MUST BE DISCONNECTED BEFORE SERVICING BY UNPLUGGING THE MACHINE OR DISCONNECTING THE CIRCUIT BREAKER.
THE MACHINE MUST BE ELECTRICALLY GROUNDED THROUGH THE LEAD IN THE 3-PRONG POWER CORD THE CORD MUST BE PLUGGED INTO A GROUNDED APPLIANCE OUTLET THAT HAS BEEN PROPERLY INSTALLED. IF LOCAL CODES REQUIRE AN ADDITIONAL GROUND CONNECTION, USE A 1/8 GAUGE OR LARGER WIRE TO CONNECT THE WASHER CABINET TO AN ESTABLISHED GROUND. IN ALL CASES, THE GROUNDING METHOD MUST COMPLY WITH ALL LOCAL ELECTRICAL CODES AND ORDINANCES.

- * MODEL DEPENDANT
- 1 LED ON
- 0 LED OFF
- * DEPRESS START BUTTON WILL CHANGE DRY TO WET
- 2 LED ON IF TUB FULL (PRESS SW. SATISFIED)

MODEL(S)	WASE4220A0AA WNSE4200A0WW	WASE4220A0WW WTSE4210A0WW	WMSE4230A0WW	WNSE4200A0AA
----------	------------------------------	------------------------------	--------------	--------------

The exploded views
and catalog numbers
are for illu

CONTROLS & BACKSPLASH

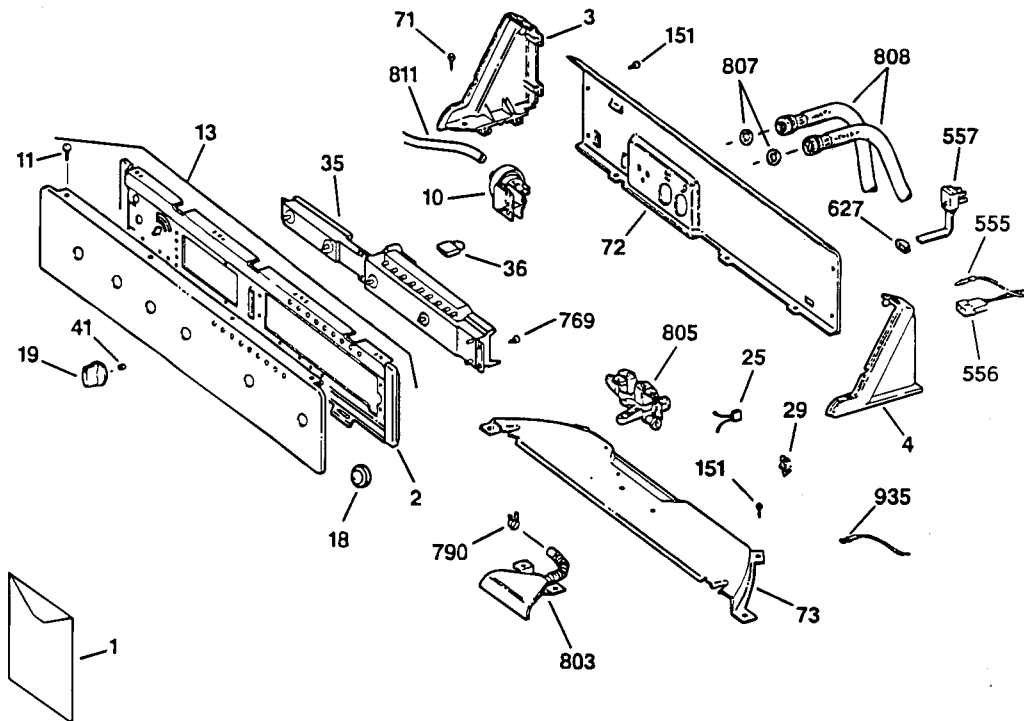

NOTE: HARNESS WIRE WH19X0163

GENERAL  ELECTRIC
PARTS CATALOG

WASHER

REF. NO.	PART NO.	PART DESCRIPTION	W	W	W	W	W	W
			A	A	M	N	N	T
			S	S	S	S	S	S
			E	E	E	E	E	E
			4	4	4	4	4	4
			2	2	2	2	2	2
			2	2	3	0	0	1
			0	0	0	0	0	0
			A	A	A	A	A	A
			0	0	0	0	0	0
			A	W	W	A	W	W
			A	W	W	A	W	W
0001	31-1748	PM INSTRUCTION INSTALL	1	1	1	1	1	1
	31-15412	PM SHEET MINI MANUAL	1	1	1	1	1	1
	49-90030	PM MANUAL USE & CARE	-	-	1	-	-	1
	49-90029	PM MANUAL USE & CARE	1	1	-	1	1	-
0002	WH46X10048	SUPPORT SWITCH	1	1	1	1	1	1
0003	WH42X2394	END CAP LH	1	-	-	1	-	-
	WH42X2397	END CAP LH WH	-	1	1	-	1	1
0004	WH42X2398	END CAP RH WH	-	1	1	-	1	1
	WH42X2395	END CAP RH	1	-	-	1	-	-
0010	WH12X10108	SWITCH PRESSURE	1	1	1	1	1	1
0011	WH02X1206	SCR8-18 AB FLT 5/8 SN WH	4	4	4	4	4	4
0013	WH42X10202	CONTROL PANEL ASM	-	-	-	1	-	-
	WH13X10009	CONTROL PANEL ASM	-	1	-	-	-	-
	WH42X10215	CONTROL PANEL ASM	1	-	-	-	-	-
	WH42X10207	CONTROL PANEL ASM	-	-	1	-	-	-
	WH42X10210	CONTROL PANEL ASM	-	-	-	-	-	1
	WH42X10201	CONTROL PANEL ASM	-	-	-	-	1	-
0018	WH01X10032	BUTTON, SWITCH	-	1	1	-	1	1
	WH01X10073	BUTTON SWITCH	1	-	-	1	-	-
0019	WH01X10060	KNOB & CLIP ASM	-	5	5	-	5	5
	WH01X10058	KNOB & CLIP ASM	5	-	-	5	-	-
0025	WH19X10014	HARNESS ATC	1	1	1	1	1	1
0029	WH02X10054	WIRE SADDLE	1	1	1	1	1	1
0035	WH12X10099	CONTROL ASM	1	1	1	1	1	1
0036	WH12X10116	CONNECTOR MODEL SELECT	1	1	-	-	-	-
	WH12X10115	CONNECTOR MODEL SELECT	-	-	1	-	-	-
	WH12X10110	CONNECTOR MODEL SELECT	-	-	-	1	1	-
	WH12X10118	CONNECTOR, MODEL SELECT	-	-	-	-	-	1
0041	WE01X0980	CLIP KNOB	5	5	5	5	5	5
0071	WH02X1205	SCR 8-18 B 1/2 HXW P	4	4	4	4	4	4
0072	WH46X10035	PANEL BACK	1	1	1	1	1	1
0073	WH46X10047	COVER BOTTOM	1	1	1	1	1	1
0151	WH02X1210	SCR 8-18 B IHW 1/2 S N	6	6	6	6	6	6
0555	WB17X5053	TERMINAL	2	2	2	2	2	2
0556	WH12X0497	HOUSING TERMINAL	1	1	1	1	1	1
0557	WH19X0311	CORDSET ASM	1	1	1	1	1	1
0627	WH12X10025	STRAIN RELIEF	1	1	1	1	1	1
0769	WB01X0500	SCR 8-18 B HXW 1/4 S	2	2	2	2	2	2
0790	WH01X2036	CLAMP HOSE	1	1	1	1	1	1
0803	WH41X10037	HOSE & WATER INLET	1	1	1	1	1	1
0805	WH13X10006	VALVE WATER	1	1	1	1	1	1
0807	WH02X0042	HOSE WASHER	2	2	2	2	2	2
0808	WH41X0058	HOSE ASM INTAKE	1	1	1	1	1	1
0811	WH41X0365	HOSE PRESSURE SWITCH	1	1	1	1	1	1
0935	WD01X1434	TERMINAL SPECIAL	6	6	6	6	6	6