

GE Consumer & Industrial

Technical Service Guide

October 2006

Profile Washers With Electronic Control and Mode Shifter Assembly

WPRE6100
WPRE8100

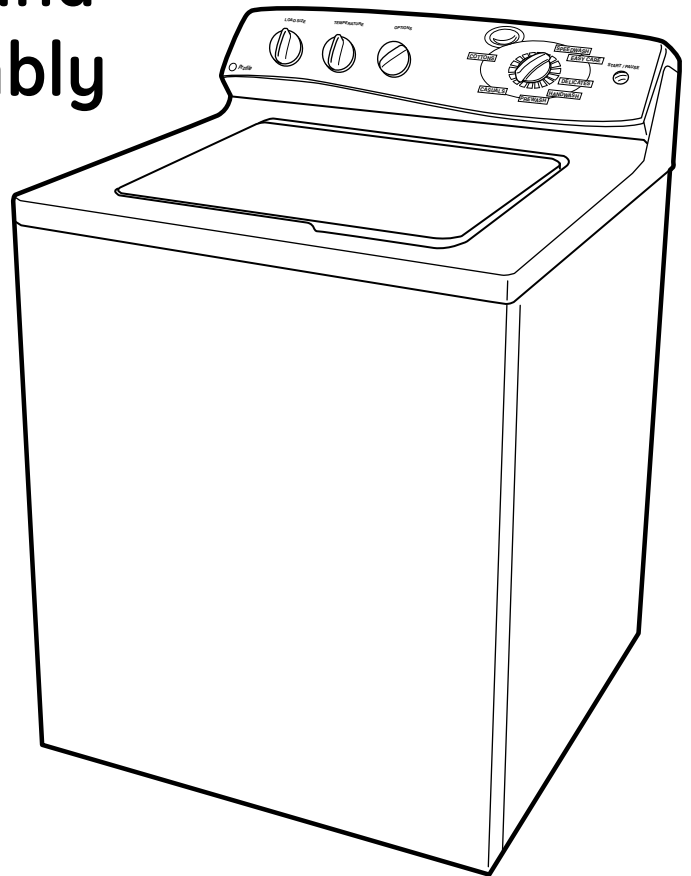

31-9145



GE Appliances
General Electric Company
Louisville, Kentucky 40225



IMPORTANT SAFETY NOTICE

The information in this service guide is intended for use by individuals possessing adequate backgrounds of electrical, electronic, and mechanical experience. Any attempt to repair a major appliance may result in personal injury and property damage. The manufacturer or seller cannot be responsible for the interpretation of this information, nor can it assume any liability in connection with its use.

WARNING

To avoid personal injury, disconnect power before servicing this product. If electrical power is required for diagnosis or test purposes, disconnect the power immediately after performing the necessary checks.

RECONNECT ALL GROUNDING DEVICES

If grounding wires, screws, straps, clips, nuts, or washers used to complete a path to ground are removed for service, they must be returned to their original position and properly fastened.

GE Consumer & Industrial

Technical Service Guide

Copyright © 2006

All rights reserved. This service guide may not be reproduced in whole or in part in any form without written permission from the General Electric Company.

Table of Contents

AC Line Filter.....	19
Agitator.....	15
Automatic Temperature Control (ATC).....	22
Belt.....	23
Brake Test.....	40
Component Locator Views.....	14
Control Board Assembly.....	16
Control Panel	16
Control Features.....	12
Cover/Lid Assembly.....	21
Diagnostics and Service Information	33
Drain Pump.....	23
Field Service Mode	34
Front Panel.....	21
Harness Fuse	26
Introduction.....	5
Inverter/Motor.....	25
Inverter/Motor Error Codes.....	37
Inverter/Motor Test.....	39
Leveling Legs	15
Lid Switch	20
Mode Shifter Coil Test.....	39
Motor and Drive System.....	7
Nomenclature	4
Schematic	41
Shaft and Mode Shifter Assembly	29
Shaft and Mode Shifter Overview	8
Shipping Rod.....	15
Suspension	26
Tub Assembly	27
Tub Cover.....	27
Warranty	42
Washer Components.....	15
Water Level Switch	18
Water Valve	19

Nomenclature

Model Number

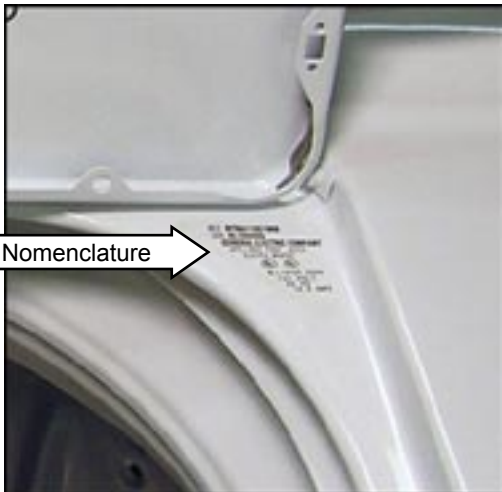
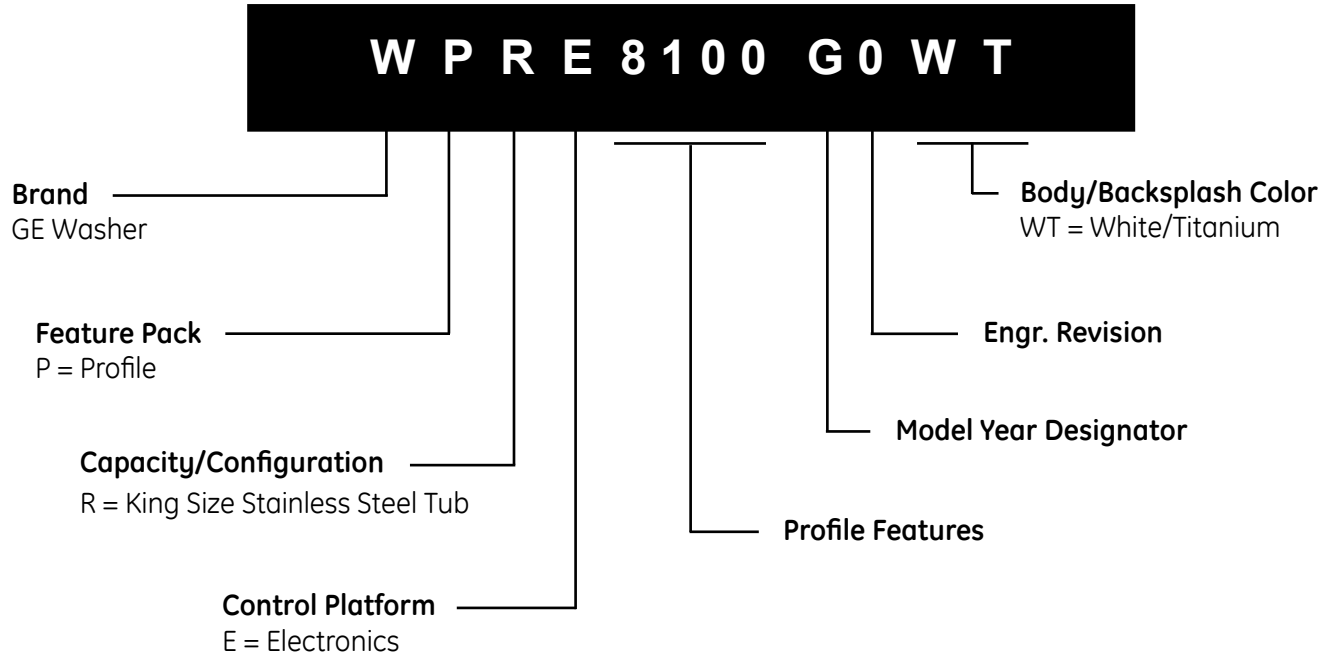

Nomenclature →

The nomenclature tag is located under the lid in the right rear corner.

Note: The first 1500 units produced have the nomenclature tag located at the lower front corner of the right side panel.

The mini-manual is located inside the control panel.

Serial Number

The first two characters of the serial number identify the month and year of manufacture.
 Example: **AL**123456S = January, 2006

A - JAN	2006 - L
D - FEB	2005 - H
F - MAR	2004 - G
G - APR	2003 - F
H - MAY	2002 - D
L - JUN	2001 - A
M - JUL	2000 - Z
R - AUG	1999 - V
S - SEP	1998 - T
T - OCT	1997 - S
V - NOV	1996 - R
Z - DEC	1995 - M

The letter designating the year repeats every 12 years.

Example:

- T - 1974
- T - 1986
- T - 1998

Introduction

The new Profile washers have the following features:

- HydroWave™ Wash System - The 360-degree stroke of the agitator moves clothes through the water slowly, in a smooth wave-like agitation, delivering thorough, yet completely gentle, cleaning performance.
- 3.5 cubic foot tub capacity.
- New backsplash shape and contrasting color.
- Washer body is white and backsplash color is titanium (WT in model number).
- New knob mounting for controls.
- New variable speed inverter/motor assembly - Provides multiple speeds for delicate to heavy clothes.
- Multiple wash/spin speed combinations - Speeds are matched to fabric type for better clothes care.
- Field Service Mode for electronic diagnostic testing.
- New drive system.
- New model/serial tag location - Under the lid in right rear corner.
- New shipping rod location.
- New suspension rod colors - White in front, green or yellow in back (depending on the model).
- Counterweight (5 lbs.) has been added for better balance control (available as a replacement part).



FEATURES	WPRE6100GWT	WPRE8100GWT
Capacity	King-size (3.50 cubic feet)	King-size (3.50 cubic feet)
Control Type	Rotary-Electronic	Rotary-Electronic
Agitator Type	GentlePower™	GentlePower™
Cycle Countdown & Status Lights	LED	LED
Number of Cycles	24	47
Wash Basket Type	Stainless Steel	Stainless Steel
Wash/Rinse Temperatures	5	7
Wash/Spin Speed Combinations	Multiple	Multiple
Water Levels	Variable	Variable
Water Temp System	PerfectTemp	PerfectTemp
Specialty Cycles		Yes - Casuals
Whites		Yes
Colors		Yes
Dark Colors		Yes
Easy Care		Yes
Handwash		Yes
Optional Soil Levels - Extra Light		Yes
Optional Soil Levels - Heavy Soil		Yes
Optional Soil Levels - Light Soil		Yes
Optional Soil Levels - Medium		Yes
Cottons Regular - Auto Soak (15 Min.)	Yes	
Cottons Regular - Extra Heavy Soil	Yes	
Cottons Regular - Extra Light Soil	Yes	
Cottons Regular - Heavy Soil	Yes	
Cottons Regular - Light Soil	Yes	
Cottons Regular - Medium Soil	Yes	
Delicates Cycle	Yes	
Easy Care - 15 Minute Auto Soak	Yes	
Easy Care - Heavy Soil	Yes	
Easy Care - Light Soil	Yes	
Easy Care - Medium Soil	Yes	
Handwash Cycle	Yes	
Casuals/Pulsed - Heavy Soil	Yes	
Casuals/Pulsed - Medium Soil	Yes	
2nd Rinse	Yes	Yes
Extended Spin	Yes	Yes
Rinse and Spin (Quick Rinse)	Yes	Yes
Soak Cycle		Yes
Speed Wash		Yes
Spin Only	Yes	
Bleach Dispenser	Yes	Yes
Fabric Softener Dispenser	Yes	Yes
Quiet Insulation Package	Deluxe Quiet Power™ 2	Deluxe Quiet Power™ 2
Color Appearance	Titanium on White (WT)	Titanium on White (WT)
Overall Depth	25 1/2 in	25 1/2 in
Overall Height	42 in	42 in
Overall Width	27 in	27 in
Height to Raise Lid 90 Degrees	51 in	51 in
Net Weight (lbs.)	150 lbs.	150 lbs.
Volts/Hertz	120V 60Hz	120V 60Hz

Motor and Drive System

The new Profile washer incorporates a new motor and drive system. The 120 VAC input powers a three phase induction inverter/motor assembly. The inverter produces approximately 340 VDC, which is pulse width modulated (PWM) to control motor speed. There is no location to check inverter output voltage to the motor. Voltage given is for information only. The motor is bidirectional, constantly reversing it's direction to provide agitation. The motor is connected by a belt to the shaft and mode shifter assembly. By energizing or de-energizing a coil, the mode shifter assembly engages or disengages the shaft and tube. This allows for agitation and spin cycle modes.

Motor status is displayed through a series of flash codes from a green LED located on the front side of the inverter just above the motor.

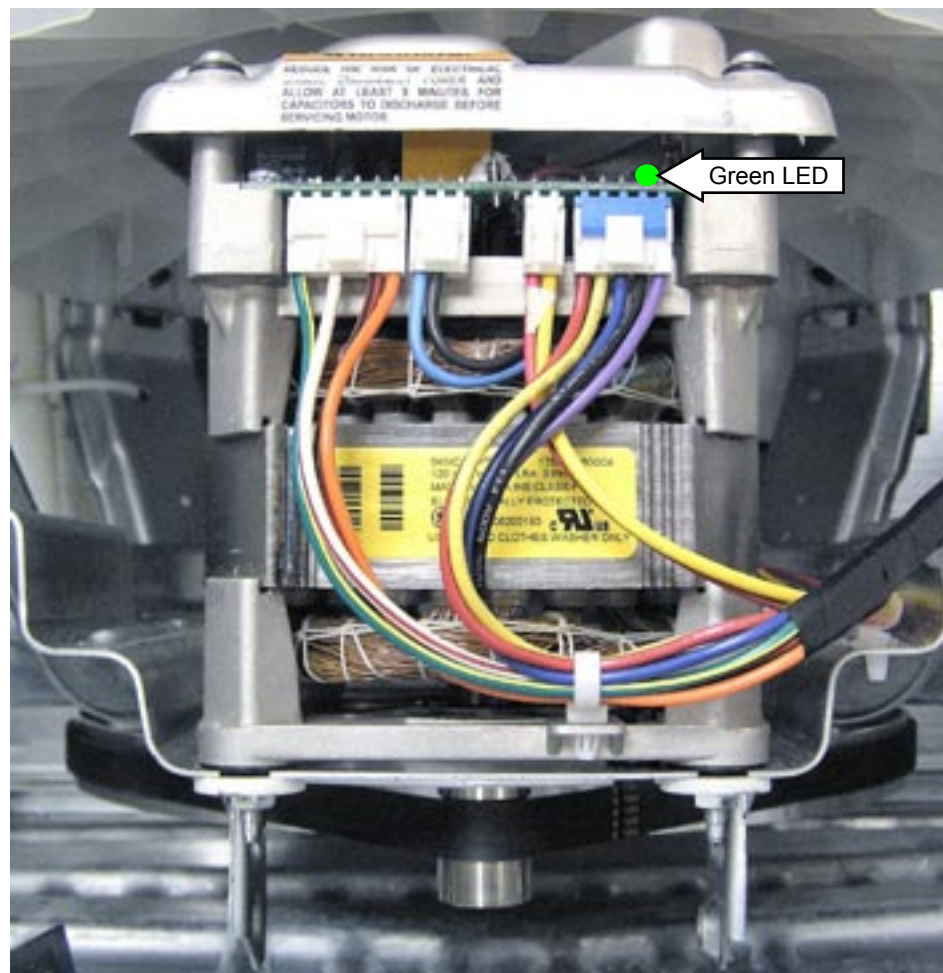

Inverter/Motor

Shaft and Mode Shifter Overview

The shaft and mode shifter assembly consists of the shaft and tube, mode shifter cam, and mode shifter coil. It operates in 2 distinct modes, spin and agitation.

The shaft and tube transfers power to the wash system. Motor power is transmitted to the shaft and tube from the drive belt to the drive pulley. The drive pulley is attached to one end of the agitator shaft and the agitator is attached to the other. The tube is fixed to the washer basket at all times.

The mode shifter changes the shaft and tube from spin to agitation. In agitation mode, the tube is fixed to the platform and the agitator shaft rotates freely. In spin mode, the agitator shaft is fixed to the tube and both rotate together.

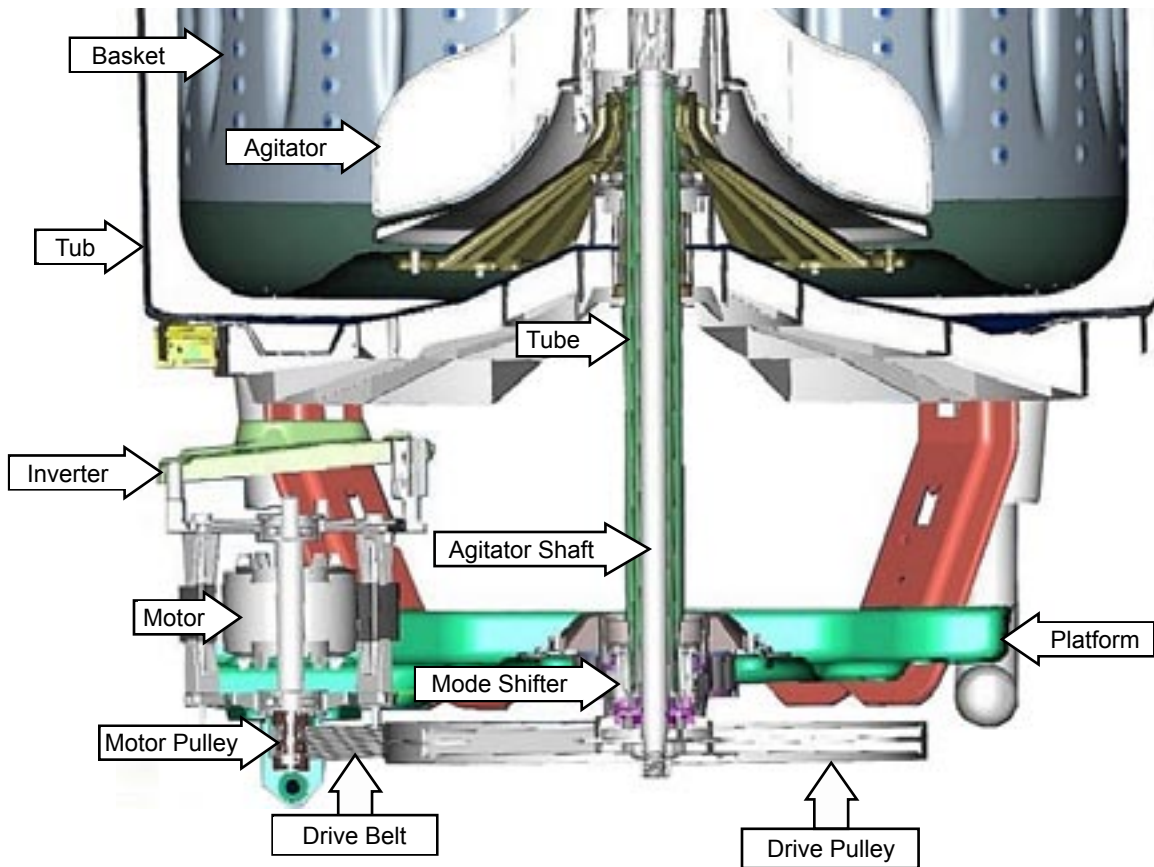

View from Right Side

Shaft and Mode Shifter Assembly

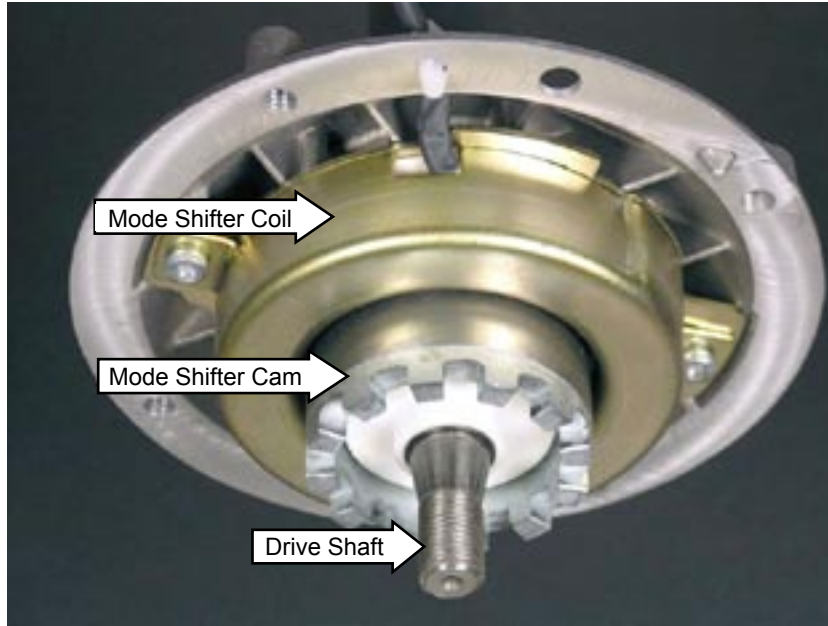

Agitate Position

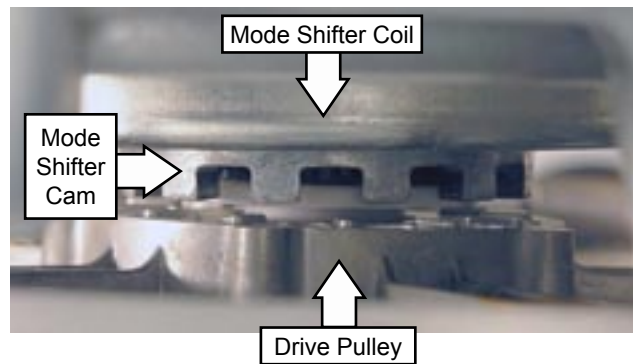

Note: Mode shifter coil energized for agitate mode; cam teeth disengaged from drive pulley.

Spin/Idle Position

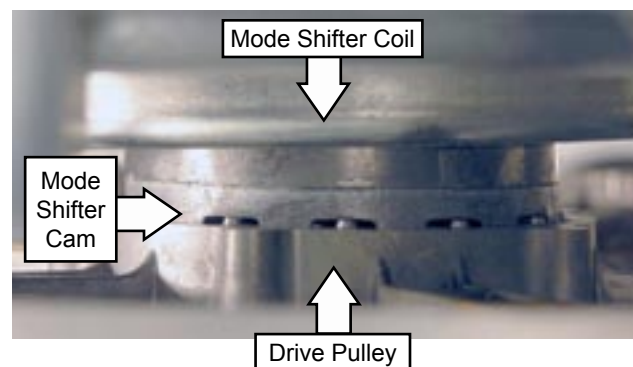

Note: Mode shifter coil de-energized for spin/idle mode; cam teeth engaged in drive pulley.

Mode Shifter Operation - Agitation

The mode shifter is controlled by the motor inverter circuit. When the washer starts the agitation cycle, the inverter energizes the mode shifter coil. The magnetic field of the coil lifts the mode shifter cam, disengaging it from the drive pulley. Without the cam engaged, the drive pulley rotates only the agitator shaft.



At the beginning of the agitation cycle, the inverter energizes the mode shifter coil with 135 VDC (PWM) for approximately 18 seconds. This high voltage pulls the mode shifter cam up from the drive pulley. During this time, the motor also rotates clockwise and counterclockwise in short strokes to ensure the mode shifter cam has been released from the drive pulley. This operation is called the **Mode Shifter Agitate Program**. It is normal to hear metal-to-metal "clunking" sounds during this time as the cam and drive pulley disengage. The washer runs this program when the agitation cycle first starts, when power is restored if lost during agitation or when the user restarts the washer if paused.

Once the Mode Shifter Agitate Program has completed (18 seconds), agitation begins. During agitation, the inverter continues to supply 30 VDC (PWM) to the mode shifter coil. This voltage is sufficient to hold the mode shifter cam away from the drive pulley throughout the remainder of the agitation cycle.

The inverter motor controls the speed of agitation. The agitator stroke rate is approximately 30 strokes per minute. This rate is the same for all cycles. The speed of the motor controls the arc. At fast speed, the arc is approximately 360 degrees. At slower speeds, the arc is substantially less. It is the distance of the arc that determines normal or gentle wash cycles.

Mode Shifter Operation - Spin



At the beginning of the spin cycle, the inverter runs a short sequence (approximately 30 seconds) to make certain the mode shifter cam is engaged with the drive pulley. The inverter does not supply voltage to the mode shifter coil during this sequence. Since the coil is not energized, the spring loaded cam drops down into the teeth of the drive pulley. During this time, the motor also rotates clockwise and counterclockwise in short strokes to ensure the cam has engaged with the drive pulley. This 30 second operation is called the **Mode Shifter Spin Program**. It is normal to hear metal-to-metal "clunking" sounds during this time as the cam and drive pulley engage.

Notes:

If the washer is paused while in agitation, it is NORMAL to hear sounds for an additional 30 seconds as the inverter control runs the Mode Shifter Spin Program to de-energize the coil and enter a pause state.

If the washer is in agitation and power is lost, the inverter control will run the Mode Shifter Agitate Program when power is restored.

If the washer is in spin and power is lost, the inverter control will run the Mode Shifter Spin Program when power is restored.

To help prevent out-of-balance conditions, the last 10 seconds of agitation on certain cycles will be short, fast strokes to help redistribute the clothes load prior to entering the spin cycle.

Control Logic Flowchart

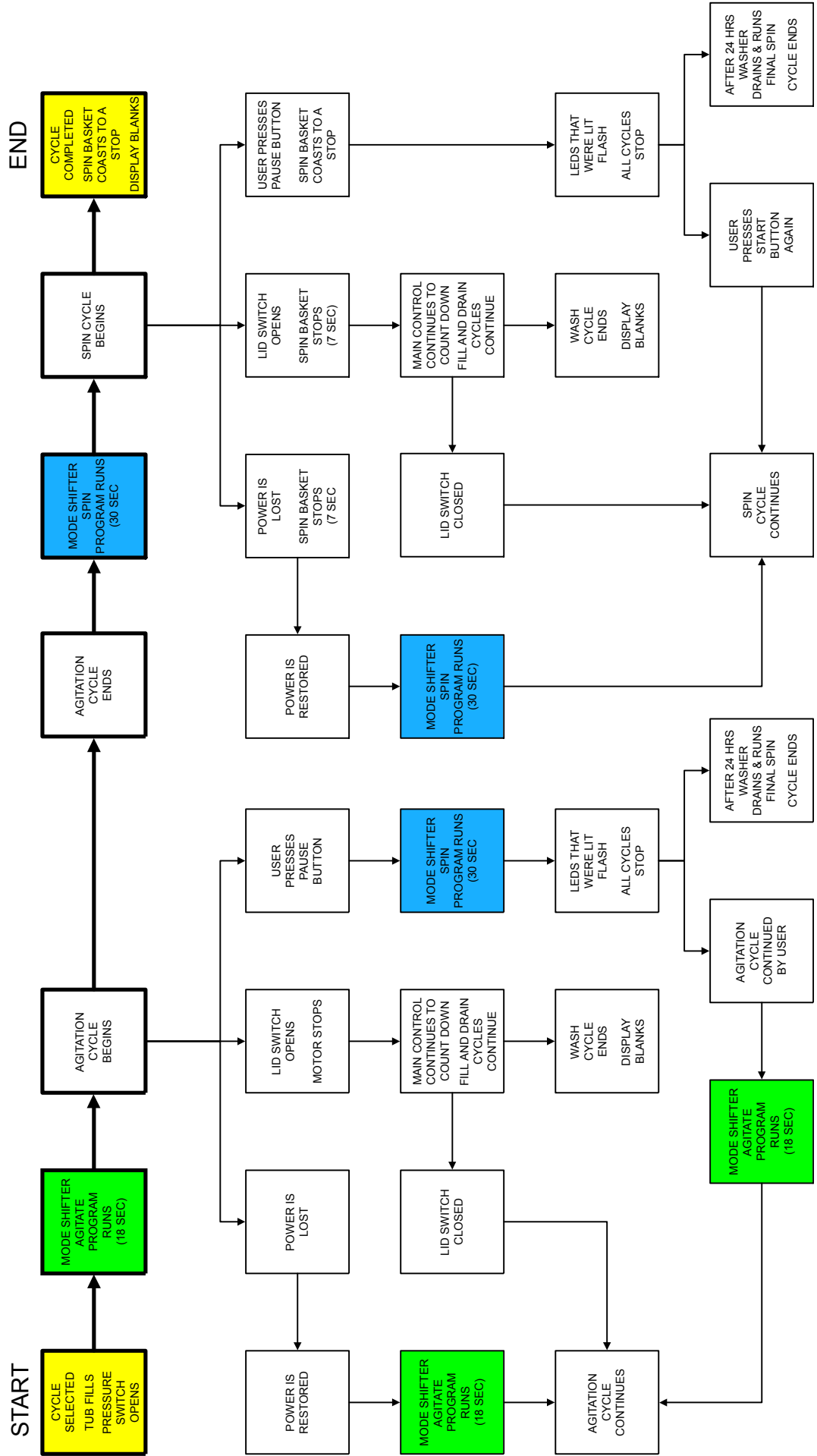

Control Features

Features and appearance may vary between models.

Profile Models

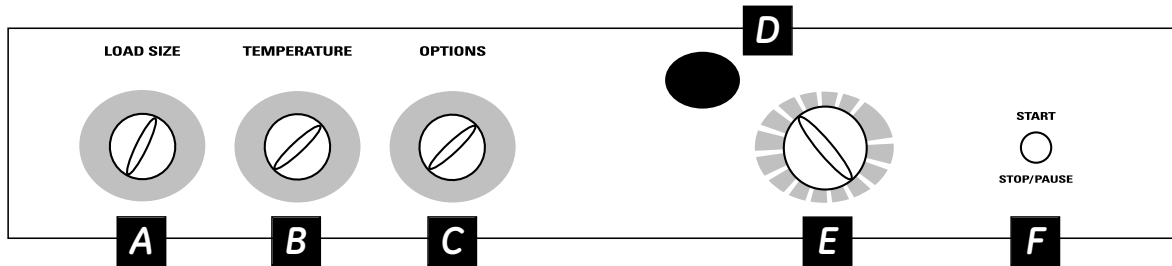

Controls

A

Load Size

Loosely load clothes no higher than the top row of holes in the washer basket. The water level should just cover the clothes. Adjust the load size accordingly.

B

Temperature

Select the water temperature for the wash and rinse cycles. Always follow fabric manufacturer's care label or instructions when laundering.

PerfectTemp senses the incoming water temperature and adjusts the fill water to obtain a more precise temperature range for all wash temperatures. For example, in a COLD wash selection, some warm water may be added to reach a temperature needed to better dissolve detergents. Often, detergents are not completely dissolved in very cold water, especially in cooler climates.

During winter months, when the water entering your home is colder, or for locations with very cold water year round, use the **PerfectTemp** plus COLD to help dissolve powdered detergents and to improve the cleaning of your clothes.

The **TAP COLD** feature turns the **PerfectTemp** feature on your washer off, and uses your household tap water temperature for a COLD wash. This can provide energy savings by reducing the amount of hot water used in your wash.

C

Options

Autosoak Option (on some models)

This option begins with a brief agitation, soaks for a specified period of time, then moves through the rest of the cycle automatically. On some models, this option is located on the Cycle Selector knob.

2nd Rinse Option (on some models)

When you use extra detergent or bleach to clean heavily soiled clothes, you may want to use the 2nd Rinse option. It provides a second deep cold rinse.

Extended Spin Option (on some models)

Use this option to extract more water from your clothes. Clothes will be drier when this option is selected and will dry more quickly in your dryer.

D *Estimated Time Remaining Display*

- Displays the **approximate** time remaining until the end of the cycle.
- If the estimated time remaining is more than 60 minutes, "1H" will flash in the display followed by the additional remaining minutes. When the time remaining is less than 60 minutes, the timer will count down.
- Cycle time is affected by how long it takes the washer to fill. This depends on the water pressure in your home. The "smart" timer "learns" the amount of time it takes to fill your washer and adjusts the total time accordingly.

E *Wash Cycle—Cycle Selector Knob*

The wash cycle controls the length of the washing process. The knob can be turned in either direction. Turning the Cycle Selector knob after starting a cycle will stop the washer and reset the cycle to the new selection. Press **START** to begin the new cycle selection.

The chart below will help you match the wash cycle setting with your clothing. The chart is ranked from longest to shortest cycle time and wash intensity.

PREWASH	For removing surface dirt from heavily soiled clothes. Make sure to follow with a regular wash cycle.
CASUALS	For wrinkle-free and permanent press items, and knits.
COTTONS	For heavy to lightly soiled cottons, household linens, work and play clothes.
EASY CARE	For wrinkle-free and permanent press items, and knits.
DELICATES	For lingerie and special-care fabrics with light to normal soil.
HAND WASH	For items labeled handwashable with light soils. Provides periods of agitation and soak during wash and rinse.
SPEED WASH	For lightly soiled items that are needed in a hurry.
DRAIN & SPIN	For draining the tub and spinning water out of the clothes.

F *START*

Press **START** to begin the cycle. Pressing **START** again or raising the lid will **PAUSE** the cycle and the Cycle indicator light will blink.

To continue the cycle, press **START** again or close the lid. If machine is paused more than 24 hours, the cycle will be cancelled. To stop the cycle, hold the button for 3 seconds. If water remains in the machine, select the **DRAIN & SPIN** cycle to drain tub and spin water out of the washer tub.

Component Locator Views

Front View

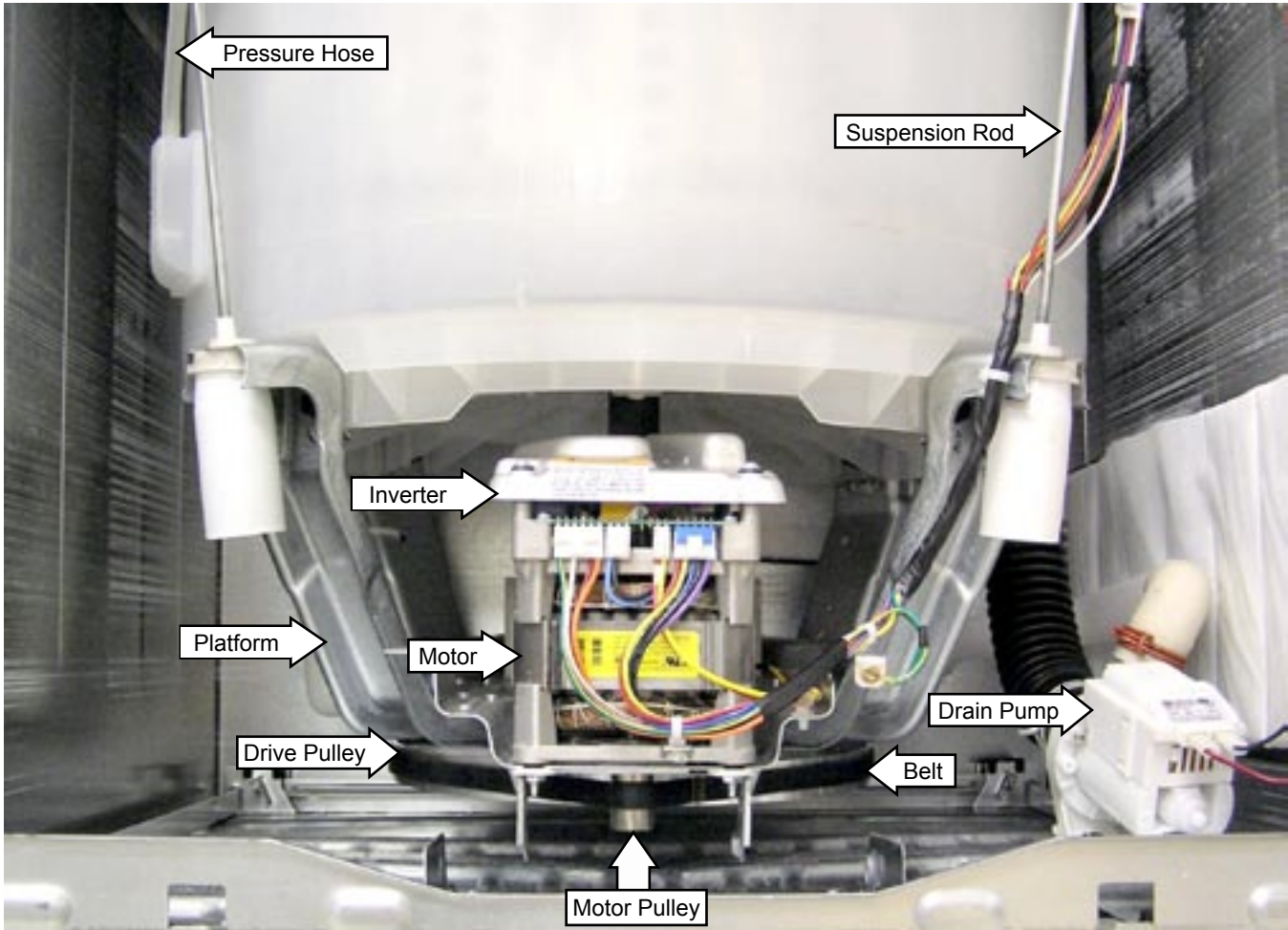

Control Panel (in service position)

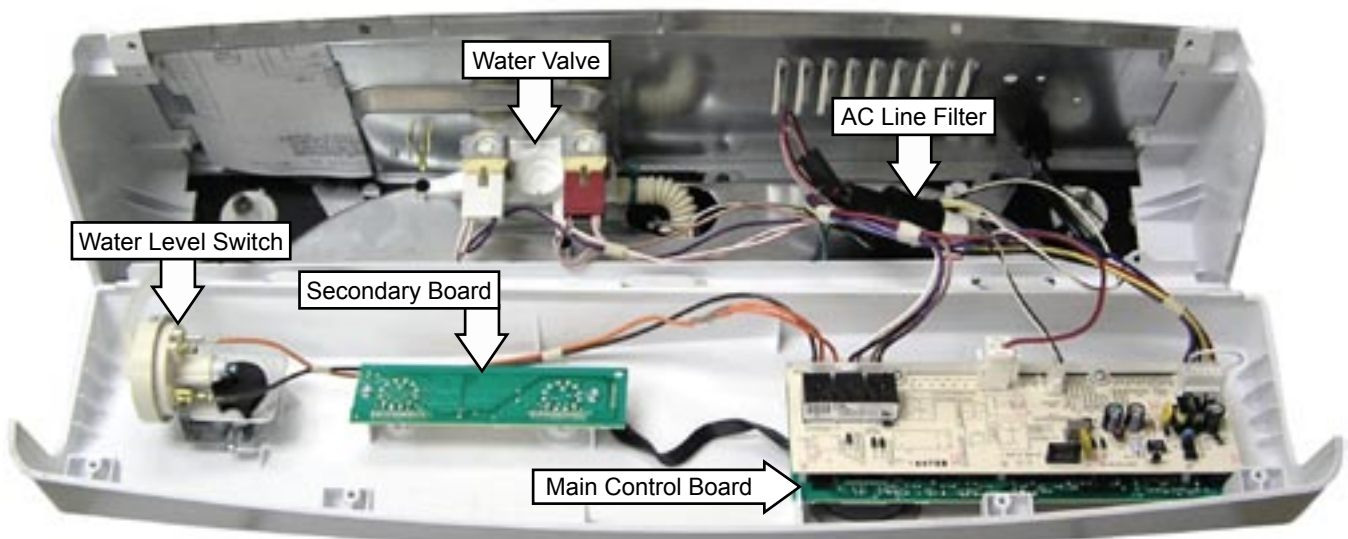

Washer Components

WARNING: Sharp edges may be exposed when servicing. Use caution to avoid injury. Wear Kevlar gloves or equivalent protection.

Shipping Rod

There is a new location for the shipping rod. The rod is inserted and removed through a hole located on the lower right side of the cabinet and now passes in front of the drain pump.

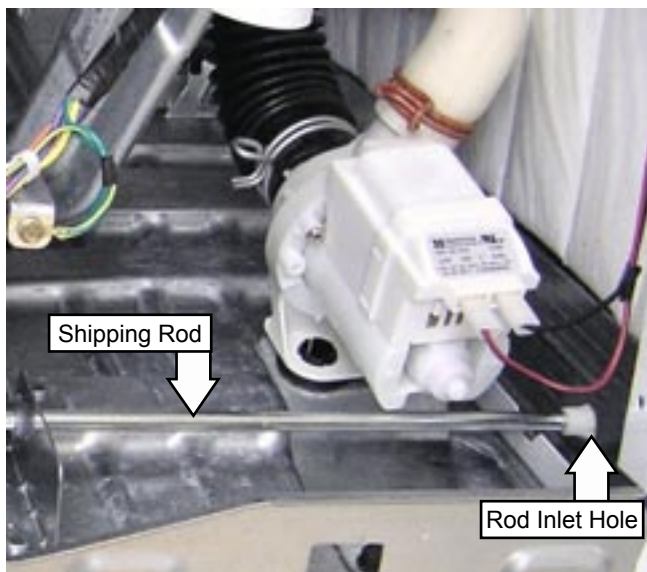

The shipping rod passes through the chassis rod brackets and the platform brackets.

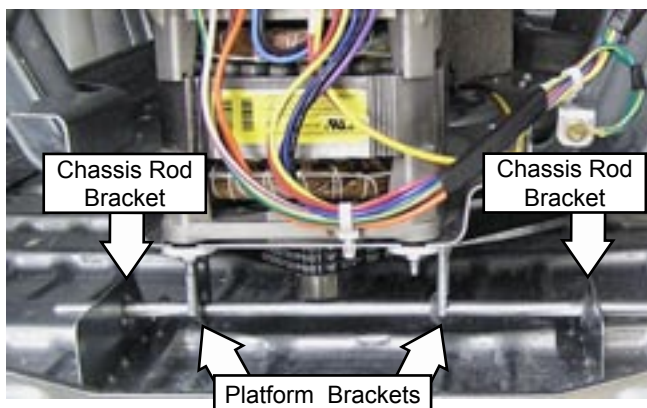

Leveling Legs

The front legs are screw type and are adjusted by turning the legs counterclockwise to increase height. The rear leveling legs are contained in an assembly and will level the rear of the washer left to right.

To level the washer, tilt the washer forward to lift the rear legs off the floor, then gently set it back down. Adjust the front leveling legs to level the washer front to back and left to right across the front.

Agitator

The agitator is a dual-action ratcheting type, which sets on an air bell coupling. Remove the agitator by grasping the bottom and sharply pulling up. To protect from back injury, use agitator strap, part number WX5X1326 or equivalent.

To align the agitator for reassembly, match the grooves in the air bell to the grooves inside the agitator. The fins on the outside of the agitator are aligned with the grooves on the inside of the agitator. To remove the air bell coupling, remove the $\frac{1}{16}$ -in. bolt and lift coupling off the shaft.



Control Panel

It is necessary to remove the control panel from the backguard and place it in the service position to access:

- Control circuit board
- Water level switch
- Water valve
- AC line filter
- ATC Thermistor

Caution: To prevent damage to the control panel, place a protective pad on the cover/lid assembly.

To place the control panel in the service position:

1. Disconnect power.
2. Remove the four ¼-in. hex-head screws from the rear of the control panel.
3. Gently pull out each top rear corner to unsnap the control panel from the sides of the unit.

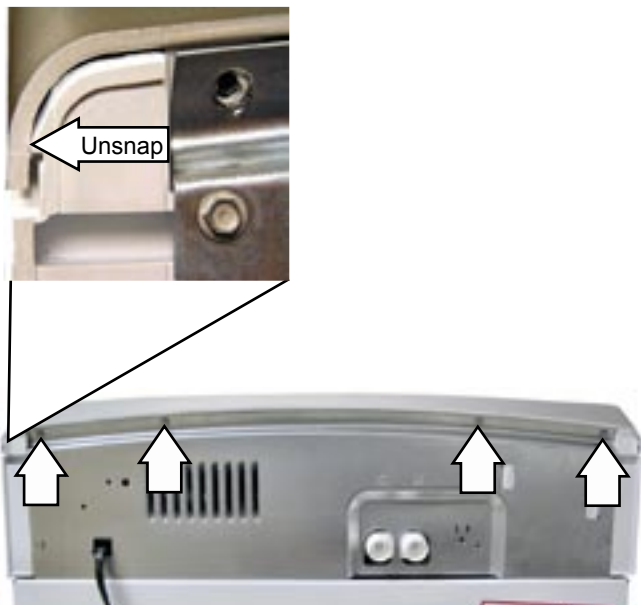

4. Rotate the top of the control panel forward approximately 1 inch and slide to the right to unlock the 3 bottom locking tabs.
5. Lift the panel up and off the cover panel and rotate down.

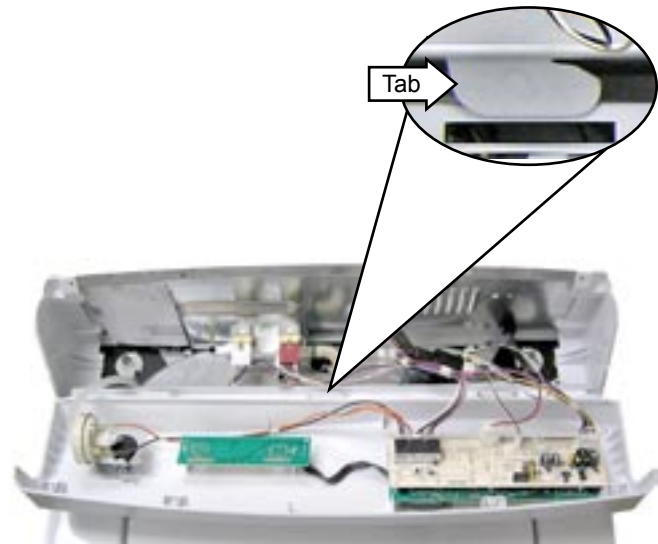

Service Position

Control Board Assembly

The control board assembly is mounted on the inside of the control panel. It is inserted in 3 panel slots and held in place by 4 screws. It consists of a secondary board permanently connected to the main board with a ribbon. The secondary board contains the water temperature control and the options selector.

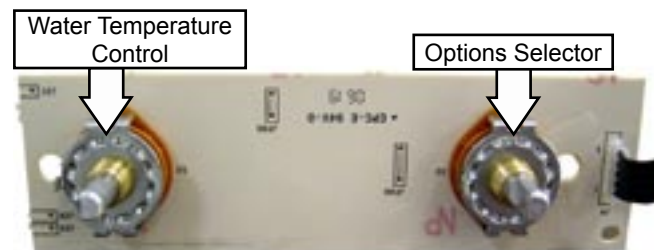

Note: The water temperature control and the options selector have detents between some of the settings. The washer will function if the knob is inadvertently set at one of the unmarked detents. Following a clockwise direction, all unmarked detents have the same value as the marked detent before it. The highlighted areas below show an example of what settings would be selected.



The main control board has harness connections at locations J5, J10, J11, and J12, and a model selector plug located at J14. When the control receives power, it checks for the presence of the model selector plug.

If no plug is detected, all LEDs will flash. Pressing the start button has no effect on control operation. All LEDs will stop flashing once a plug is installed.

Note: The model selector plug must be transferred when control board is replaced.

Main Control Board - Rear View

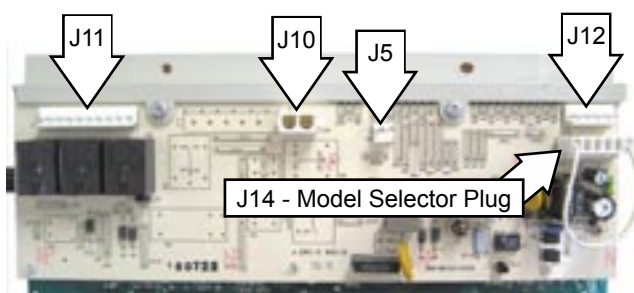

Note: The LEDs in the 2 digit display can be as much as 1/8-in. lower than the description on the backslash.

Main Control Board - Front View

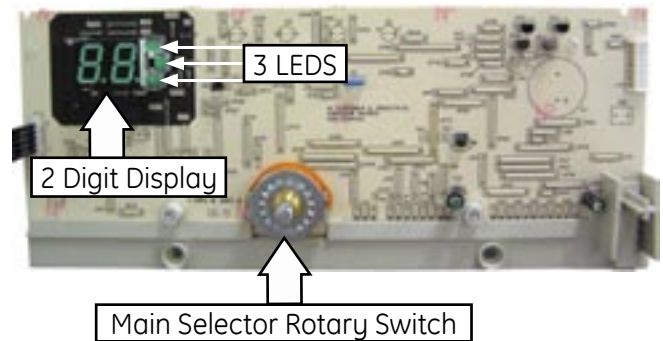

To remove the control board assembly:

1. Disconnect power.
2. Place the control panel in the service position. (See **Control Panel**.)

Note: The knobs are **NOT** mounted to the controls or switches. Each knob rests and rotates on a collar imbedded in the control panel. The collar protects the component from damage if something hits the knob. A locking on the back of the knob secures the knob to the collar.

3. Remove the control, temperature, and options knobs by gently pulling each outward.
4. Disconnect wire harnesses J5, J10, J11, and J12 from the main control board.
5. Remove the 2 1/4-in. hex-head screws from the main control board and the secondary board.

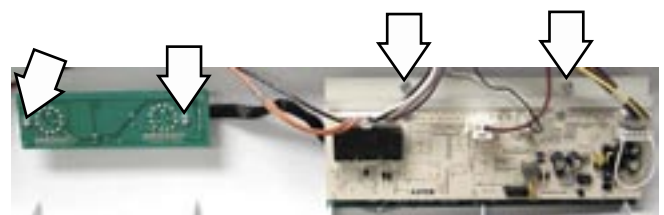

Water Level Switch

- The minimum fill volume is 9 gallons. The water level measures approximately 7½ inches (6 holes) above the bottom of the basket.
- The maximum fill volume is 22 gallons. The water level measures approximately 15 inches above the bottom of the basket (between holes 2 and 3 from the top).

Minimum Fill Level



Note: The water level switch orange wire has a locking tab that must be depressed to be disconnected. To remove this wire from the water level switch, depress the clip using a small blade screwdriver and pull the wire off the terminal as shown.

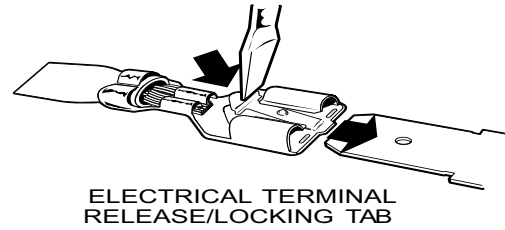

4. Disconnect the 2 wires and the pressure hose attached to the water level switch.

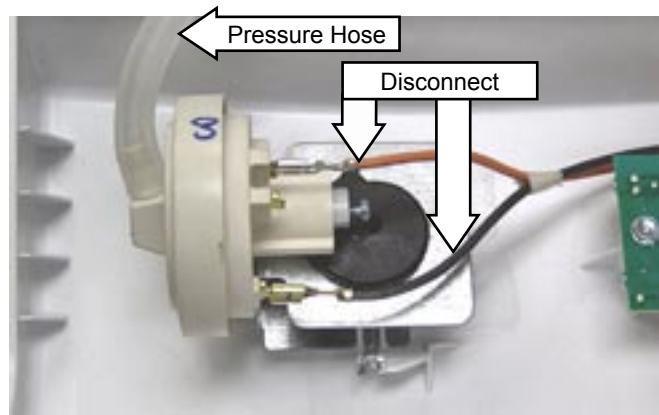

5. Press the plastic locking tab, rotate the switch counterclockwise, and pull the switch out of the control panel.

To remove the water level switch:

1. Disconnect power.

Note: The water level switch knob is mounted to the backsplash, not the switch.

2. Remove the water level switch knob by gently pulling it outward.
3. Place the control panel in the service position. (See **Control Panel**.)

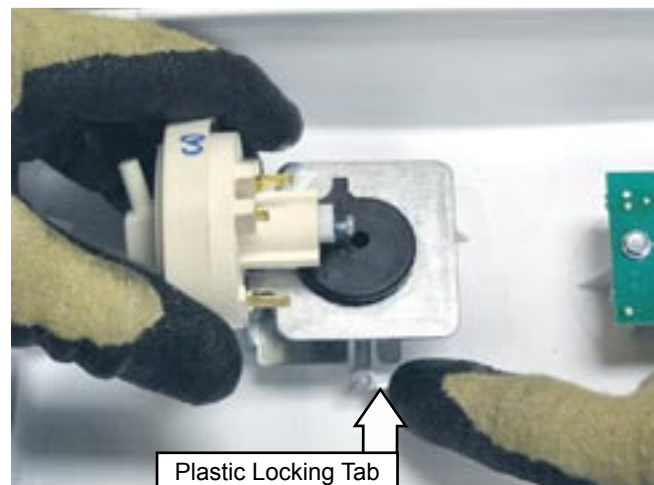

Water Valve

The water valve is a 120 VAC, dual solenoid type, and is accessed by placing the control panel in the service position. It is inserted and retained in a cutout in the rear of the backguard and held in place by 2 hex-head screws. It is only available as a complete assembly.

- The water valve has a flow rate of 2.1 gallons (8 liters) per minute.
- If the pressure switch is not satisfied within 20 minutes, a fill error code will be recorded. If the pressure switch has not opened in 45 minutes, the main control will de-energize the water valve and place the washer in pause mode.
- Each solenoid coil has an approximate resistance value of 1.1K Ω .

To remove the water valve:

1. Disconnect power.
2. Place the control panel in the service position. (See **Control Panel**.)
3. Remove the fill hoses from the water valve.
4. Disconnect the white wire harness from the hot water (H) solenoid valve.
5. Disconnect the red wire harnesses from the cold water (C) solenoid valve.

Note: The fill funnel hose is difficult to remove.

6. Remove the fill funnel hose. Squeeze the clamp and slide it back. Carefully break the hose loose by inserting a small flat-blade screwdriver under the hose to break the seal.

7. Remove the two ¼-in. hex-head screws that hold the valve to the cabinet.

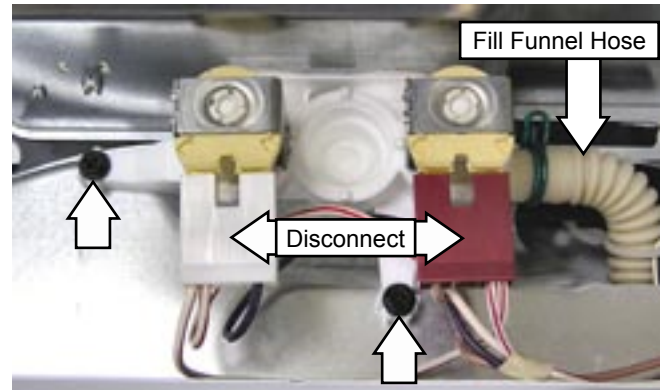

AC Line Filter

The potential exists for the washer to cause electronic devices in the vicinity to experience disruption. In addition, electrical devices in the area could cause erratic behavior in the washer electronic control. To eliminate the likelihood of disruption, the washer is equipped with a conductive noise filter. Should interference with electronic devices or erratic control behavior be reported, suspect a problem with the filter. The ground wire attached to the filter must have a good connection for the filter to operate properly. Check to make certain that the ground wire is connected properly before replacing the filter.

The filter is accessed by placing the control panel in the service position. (See **Control Panel**.)

Note: When untaping and disconnecting the wires from the AC line filter, note wire locations.

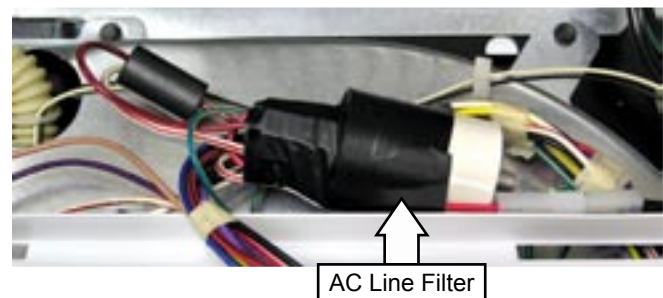

Lid Switch

The lid switch is installed in the cover assembly at the right front corner of the lid recess. The switch is held to the underside of the cover by a latch.

The lid switch is a safety feature that prevents the washer from agitating or spinning when the lid is open. The switch is closed by a magnet that is attached to the lid. When the lid is shut, the magnet will cause the switch to close the circuit, allowing normal functions to occur. When the lid is opened, the switch will open the circuit, which will prevent agitating or spinning.

If the lid switch:

- Is closed, it will provide 120 VAC to the inverter/motor assembly at pin 6 of the C2 connector.
- Is open, agitation and spin will not occur, but the washer will continue to count down, fill with water and drain at the appropriate times in the cycle.
- Was opened during a cycle, left open and the timer finished the cycle, when the lid is closed again, the inverter completes a spin algorithm to ensure the mode shifter is de-energized.
- Is open, the automatic temperature control (ATC) will remain activated. The temperature of the water entering the washer with the lid open may vary greatly, due to the cycling of the fill valve solenoids.
- Opens during agitation, the control will keep the mode shifter energized. When the lid switch closes while still in agitation, the washer will resume agitation.
- Opens during the execution of the mode shifter agitate program, the control will stop the agitate program and drop the mode shifter voltage to 0 VDC. When the lid switch is closed again, the control will run the mode shifter spin program and then re-run the agitate program from the beginning.
- Opens during the mode shifter spin program, the control will stop the spin program. When the lid is closed again, the control will run the spin program from the beginning.

Note:

- Lid switch openings are not retained in memory if power is interrupted.
- The main control does not monitor the lid switch. The motor inverter control monitors lid switch operation by monitoring voltage through pin 6 on connector C2.
- As a safety measure, the inverter control monitors lid openings by recording motor run sequences. If the control runs 4 continuous agitation/spin cycles (usually 2 complete wash cycles) WITHOUT seeing the lid switch open, it will shut down the motor and initiate a lid switch error code. This error will prevent the motor from operating until the problem is repaired.

To access the lid switch it is necessary to open the lid and reach under the cover assembly. To release it from the cover requires pressing the lid switch latch in firmly and gently pushing the switch up. The switch can then be lifted through the opening.

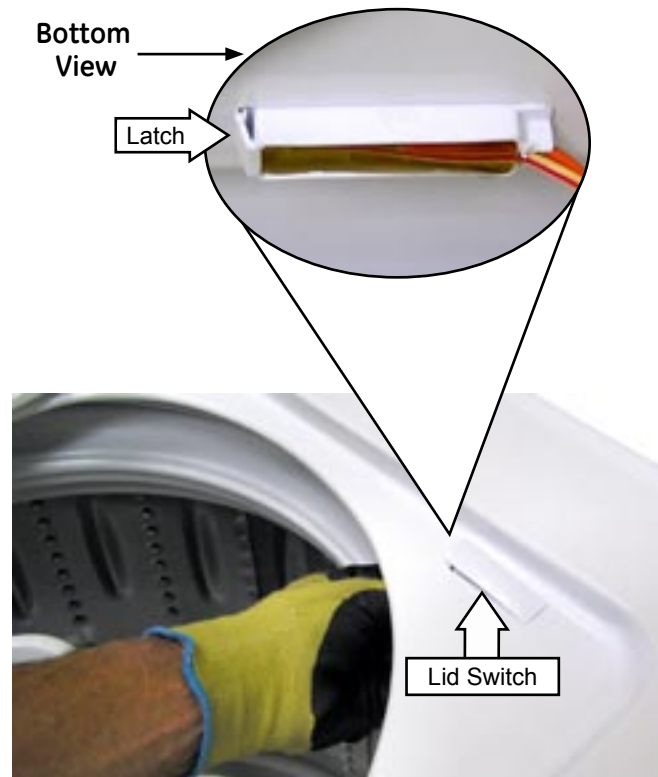

Front Panel

The front panel is a removable, galvanized sheet metal section. The front panel is fastened at the top by 2 metal spring clips, and at the bottom by 2 metal tabs which protrude from the base of the unit into slots in the panel bottom.

Most major mechanical components can be accessed by removing the front panel.

To remove the front panel:

1. Locate 2 spring clips between the top cover and front panel by aligning a putty knife with left or right edge of lid.
2. Insert the putty knife and push forward to release clips.



3. Rotate the front panel forward and lift off the bottom tabs.



Cover/Lid Assembly

The cover/lid assembly is fastened at the front by 2 screws, on the sides by 2 metal catches, and at the back by 3 locking tabs that protrude from the bottom of the control panel.

Note: Do not allow lid to swing open when cover/lid assembly is removed. Damage may result.

To remove the cover/lid assembly:

1. Remove the front panel. (See **Front Panel**).
2. Remove the lid switch. (See **Lid Switch**.)
3. Remove the two ¼-in. hex screws securing the front of the cover/lid assembly to the cabinet.



4. Pull the top cover toward you while lifting up the front edge to release the side catches. Slide the top cover to the left to release from the 3 tabs.



Automatic Temperature Control (ATC)

- The automatic temperature control (ATC) is a feature that utilizes a thermistor to regulate the water fill temperature.
- The thermistor has a negative temperature coefficient (as temperature increases, resistance decreases).
- The thermistor is located in the outlet of the fill funnel and will measure 50K Ω at room temperature (77°F / 25°C).
- If the thermistor reads outside the expected range (10K - 120K Ω), the main control will default to the following pre-programmed fill temperature settings:
 - Tap Cold = cold water valve only
 - Cold = cold water valve only
 - Cool = hot and cold water valves
 - Colors = hot and cold water valves
 - Warm = hot and cold water valves
 - Hot = hot water valve only
- When both valves are energized, the internal orifices in the valves meter the flow to a 60% cold and 40% hot ratio.
- With the lid open, ATC will remain activated. The temperature of the water entering the washer with the lid open may vary greatly from customer expectations due to the cycling of the fill valve solenoids.
- Extreme water temperatures at low pressure can cause the ATC to use it's maximum number of activations and revert to a preset fill routine. The main control will not allow the water valve to cycle more than 25 times per fill.

Resistance can be measured at the wire harness located on the control board location J5. Make sure to unplug the connector to isolate the thermistor before taking resistance readings.

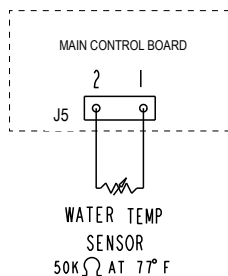

To determine the temperature of the incoming water, the main control measures the difference between the voltage sent and the voltage returned from the thermistor. The main control then makes temperature adjustments accordingly.

The main control should fill the tub with water within +/- 10 to 15°F of set temperature by opening or closing the hot and cold water valves.

ATC Temperature Chart	
Temperature Setting	Water Temperature
Tap Cold	Cold Tap Water
Cold	62°F (+/- 10°F)
Cool	70°F (+/- 10°F)
Colors	80°F (+/- 10°F)
Warm	95°F (+/- 10°F)
Hot	125°F (+/- 15°F)

To remove the ATC thermistor:

1. Place the control panel in the service position. (See **Control Panel**.)
2. Disconnect the wire harnesses on the main control board. Remove the 2 wires and the pressure hose attached to the water level switch. (See **Water Level Switch**.)
3. Remove the control panel from the washer.
4. Remove the cover/lid assembly. (See **Cover/Lid Assembly**.)
5. From inside the tub, remove the two ¼-in. hex-head screws that attach the funnel to the washer.
6. Remove the plastic wire tie, pull and unsnap the thermistor from the top of the fill funnel. Pull the wires and connector down through the opening.

Note: Make certain the gray rubber gasket is in place on the thermistor when reassembling.

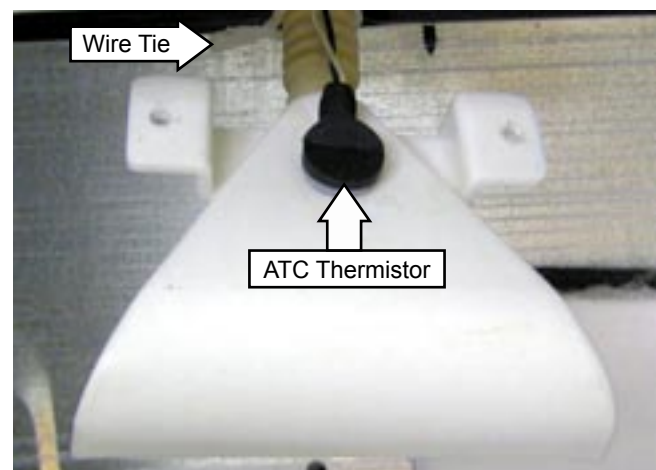

Drain Pump

The drain pump is coupled to a 120 VAC, 60 Hz, 85 watt motor. The pump motor has an approximate resistance value of 12 Ω .

The main control monitors the pump for proper operation. If no current is detected, or current detected is stable, exhibiting no change during pump out, the control will initiate a field service error code.

Note: If a wash cycle has started and the customer stops the washer by holding the Start/Pause button for 3 seconds, the pump will not drain any water in the tub. The washer will go through a spin algorithm to de-energize the mode shifter and shut down. The water stays in the tub.

To remove the pump:

Note: Water will remain in hoses even when the tub appears empty. Use care to avoid water spills.

1. Disconnect power to the machine.
2. Lower the drain hose into a small bucket to remove any water remaining in hose.
3. Remove the front panel. (See *Front Panel*.)
4. Disconnect the pump wires.
5. Pinch off the black sump hose to prevent water spills.
6. Remove hose clamps and hoses from the pump.
7. Remove two $\frac{3}{8}$ -in. hex-head screws.

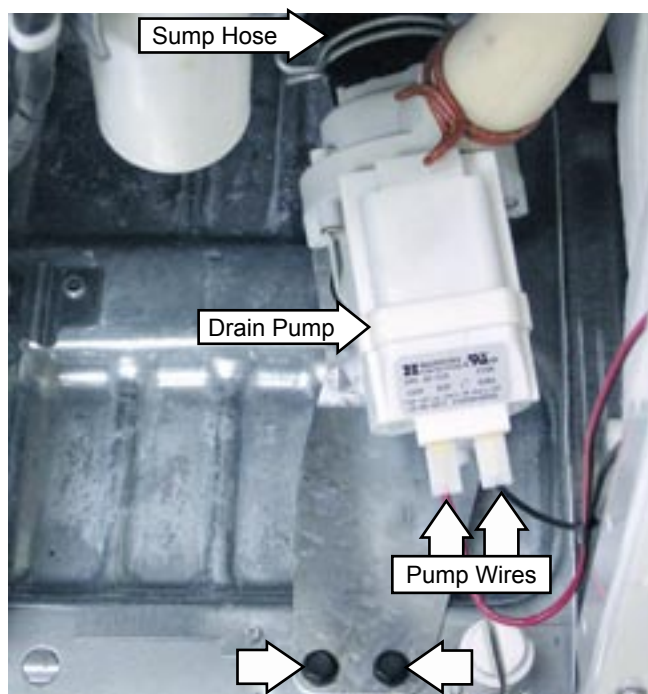

Belt

- Since the belt provides constant tension, there is no need for adjustments (an adjustment method is not provided).
- A worn or damaged belt can result in excessive brake time and will initiate a motor inverter slipping belt error code. This code will prevent the motor/inverter from operating.
- To replace the drive belt it may be helpful to use the belt install tool (part number WX05X10102).

Belt Install Tool Kit



To replace the drive belt using the tool kit:

Note: If not using the belt install tool, follow steps 1 through 3, and 6 through 7. Remove wire tie after step 7.

1. Disconnect power.
2. Remove the front panel. (See *Front Panel*.)
3. Center belt on drive pulley and secure tightly with wire tie as shown on following page. Align wire tie as shown.
4. Stretch the belt install tool to fit over the end of the motor shaft. (See Figure A.)
5. Slide belt install tool upward until it snaps into the first groove of the motor shaft. (See Figure B.)
6. Center belt on motor shaft grooves and slowly turn drive pulley clockwise.
7. Continue rotating drive pulley until belt is fully engaged.
8. Remove wire tie and belt install tool.

(Continued next page)

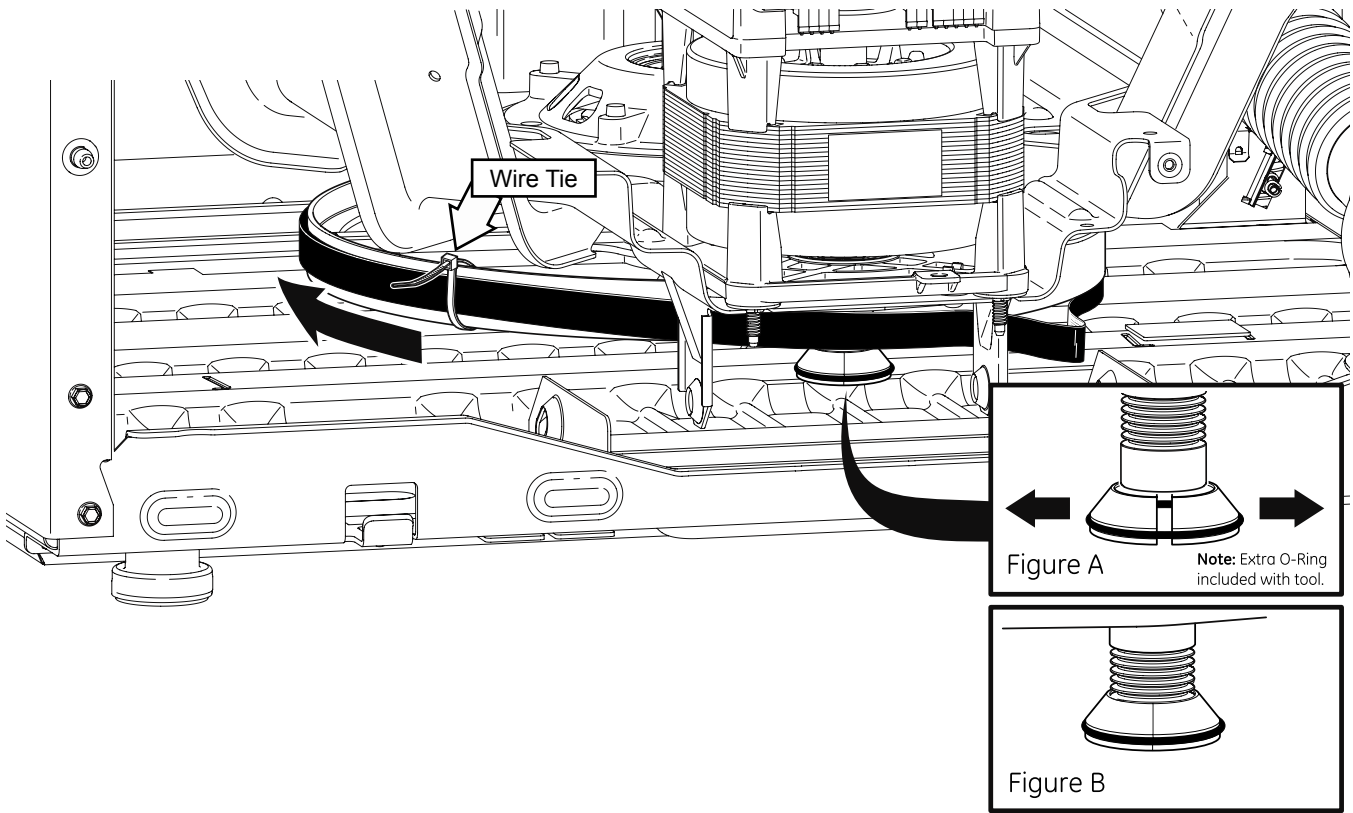

Note:

- A new belt will be slightly smaller than the drive pulley.
- A belt that has been installed on the drive pulley will stretch to the diameter of the pulley over time. This is normal and does not indicate a bad belt.



New Belt on Pulley

Inverter/Motor

The inverter/motor assembly receives 120 VAC, which the inverter converts to approximately 340 VDC. The inverter then uses pulse width modulation (PWM) to supply the motor with an AC varying frequency to control speed.

Note: There is no location to check inverter output voltage to the motor. Voltage given is for information only.

The inverter/motor assembly consists of a motor and inverter board. A brake resistor is molded into the underside of the inverter cover and absorbs energy from the reversing of the motor during the braking cycle. A Hall effect sensor mounted on the inverter board measures motor speed (RPM).

The motor and inverter are available only as an assembly.

WARNING: Do not attempt to remove the inverter cover to service the board or brake resistor.

Note:

- There is a non re-settable fuse, located in the motor harness along the right side of the cabinet. If the fuse is open, agitate, spin, and mode shifting will not occur.
- If the motor speed sensor fails, the motor will not run.
- Since the electronic control receives no feedback from the inverter motor assembly, if the motor is not operating, the washer will still fill with water, count down on the display, and drain.
- If during an agitation cycle, water leaks from the tub and resets the pressure switch, the main control stops the motor, the inverter goes through the mode shifter spin program to de-energize the cam and the washer starts to refill with water. The motor will not run again until the pressure switch is satisfied, at which time the inverter control will run the mode shifter agitate program.
- If the mode shifter circuit fails or the coil opens, the tub will move back and forth with the agitator during the wash cycle.

To remove the inverter/motor:

1. Disconnect power.

WARNING: Exposed terminals, PC board, and rotating parts may cause injury and/or electrical shock. To reduce the risk of electrical shock, disconnect power and allow at least 5 minutes for capacitors to discharge before servicing motor. An audible clicking sound will be heard when the inverter capacitor discharges (inrush relay closing).

2. Remove the front panel. (See **Front Panel**.)
3. Disconnect 3 wire harnesses from the motor.
4. Release the compression tabs that attach the wire retainer to the front of the platform.
5. Remove the belt by rolling it off the bottom of the motor pulley.
6. Remove the front two $\frac{3}{8}$ -in. motor nuts and loosen the rear 2 nuts.

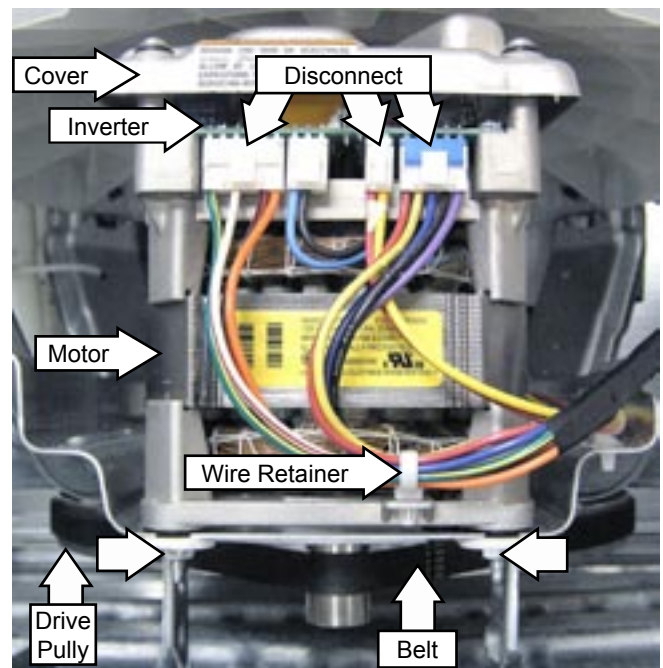

Note: Minimal clearance exists between the 2 rear $\frac{3}{8}$ -in. motor nuts, isolators, and the drive pulley.

7. Raise the front of the motor high enough to disengage the motor alignment pin from the pin locator hole then slide the motor forward so that the 2 rear spacers clear the drive pulley.
8. Remove the rear two $\frac{3}{8}$ -in. motor nuts.
9. Tilt the top of the motor towards the shaft and tube. Lift and remove the motor from the platform.

WARNING: The motor casing is NOT at chassis ground potential. Voltage may be present on the motor casing. To prevent electrical shock, do not touch the motor when connected to power.

Caution: To prevent motor, inverter, or main control board damage, make certain all isolators are in place when reinstalling motor to platform.

Note: When replacing the motor, ensure the motor alignment pin is fully inserted in the pin locator hole in the platform before tightening motor nuts.

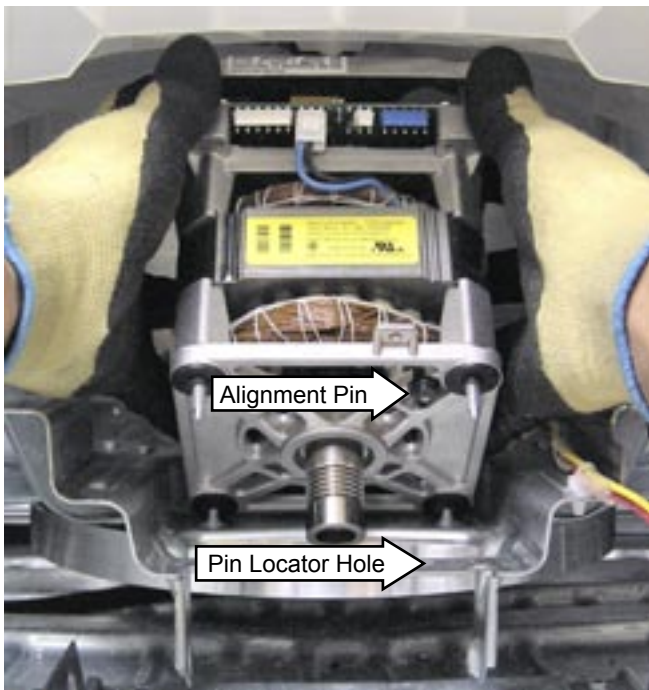

Note: When replacing a motor, check its brake operation. Place washer in a spin cycle and lift the lid after it has reached full speed. The basket should stop within 7 seconds. If time exceeds 7 seconds check the lid switch operation, and check the belt for worn ribs or slippage due to residue on the belt or pulleys.

Harness Fuse

A non re-settable 10 amp fuse is wired in the neutral side of the line. The fuse is wrapped in the motor harness located along the right side of the cabinet.

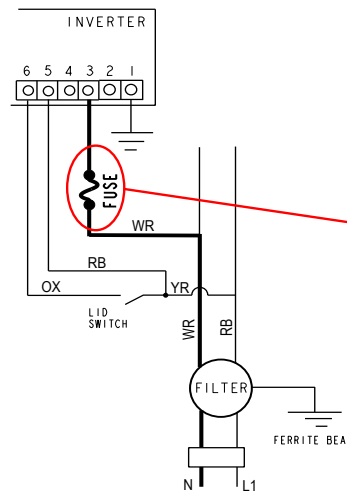

If the fuse is open, agitate, spin, and mode shifting does not occur. Check the fuse connections and wiring harness.

Caution: Bending the harness can damage the fuse.

If the harness is OK, check the inverter/motor, a shorted brake resistor or internal motor problem can cause fuse failure.

Note: If the fuse is open, use harness fuse kit (part number WH49X10041). Instructions are included with the kit.

Suspension

The tub and motor assembly (spin basket, outer tub, inverter motor, shaft and mode shifter assembly and platform) is suspended by four rod and spring assemblies. The rod and spring assemblies are attached to each corner of the cabinet. They extend down and connect to the platform. This arrangement provides limited movement to the tub and motor assembly, independent of the cabinet when agitating and spinning, thus reducing cabinet travel and vibration. Front and rear suspension rod compressions vary to compensate for different model characteristics. The rods are color-coded to ensure that they are replaced in the correct position.

The outer tub has 4 dampening straps attached to the four corners of the cabinet. These straps prevent excessive outer tub rotation and movement during the wash cycle.

Tub Cover

Note: The tub cover can be replaced without removing the tub.

To remove the tub cover:

1. Remove the front panel. (See *Front Panel*).
2. Remove the cover/lid assembly. (See *Cover/Lid Assembly*).
3. Disconnect 4 dampening straps from the tub cover by removing four $\frac{5}{16}$ -in. hex-head screws.

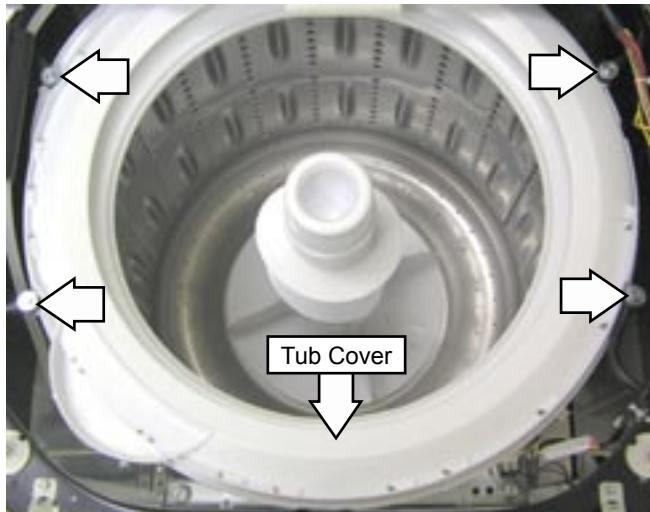

4. Release the cover from the outer tub by lifting the 8 tabs.
5. Raise the front of the cover to clear the front cabinet brace and tilt the tub forward.
6. Carefully lift and remove the cover from the tub.



Tub Assembly

Note: The motor can be replaced without removing the tub. (See *Inverter/Motor*.) The tub assembly must be removed when replacing the spin basket, outer tub, or certain speed drive components.

To remove the tub assembly:

1. Disconnect power.
2. Lower the drain hose into a small bucket to remove any water remaining in the tub.
3. Remove the front panel. (See *Front Panel*.)
4. Remove the cover/lid assembly. (See *Cover/Lid Assembly*.)
5. Remove the tub cover. (See *Tub Cover*.)
6. Remove the agitator. (See *Agitator*.)
7. Remove the $\frac{7}{16}$ -in. hex-head bolt and air bell coupling from the agitator shaft.
8. Remove the air bell.

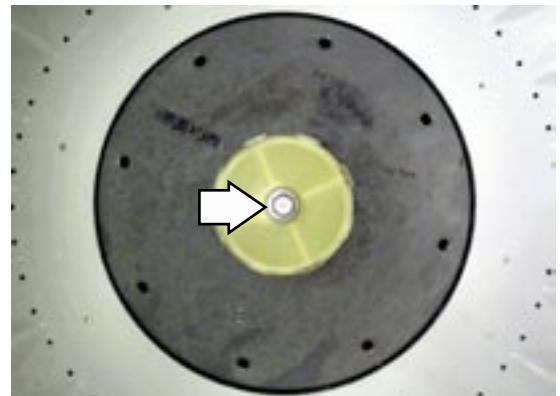

Note: When replacing air bell, tighten the $\frac{7}{16}$ -in. hex-head bolt to 90 in. lbs. of torque.

Caution: Use only a rubber mallet, dead blow hammer, or impact wrench to remove the hub nut. Use of a steel head hammer may result in damage to the spin basket.

Note: The word “LOOSEN” and an arrow appear on the hub nut. Turn clockwise to remove.

9. Remove the left-hand thread, 1¹¹/₁₆-in. nut using an impact wrench or a hub nut wrench (WX5X1325) and rubber mallet or dead blow hammer.

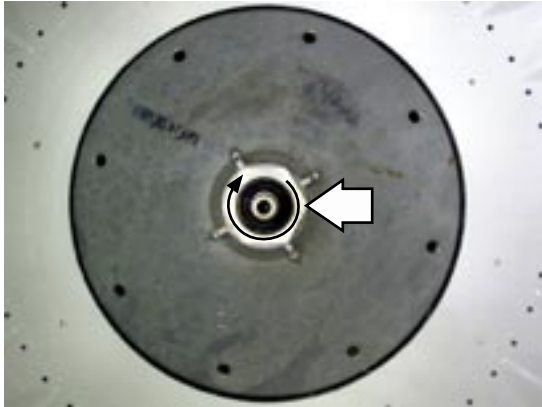

The hub nut must be torqued to 75 ft. lbs. To ensure the hub nut is tightened sufficiently when using a hub nut wrench, align the wrench with the holes in the basket and use them as a guide to determine when the nut will not move any further. Impact wrenches are set to more than 75 ft. lbs. and should tighten the nut sufficiently.

WARNING: Exposed terminals, inverter board and rotating parts may cause injury and/or electrical shock. To reduce the risk of electrical shock, disconnect power and allow at least 30 seconds for capacitors to discharge before servicing motor. A distinct click can be heard from the relay on the inverter when the capacitor is discharged.

10. Disconnect the 2 outer motor harness connectors, and the ¼-in. hex-head screw that attaches the platform ground wire.
11. Release the compression tabs that attach the 3 motor wire harness retainers to the front of the platform.

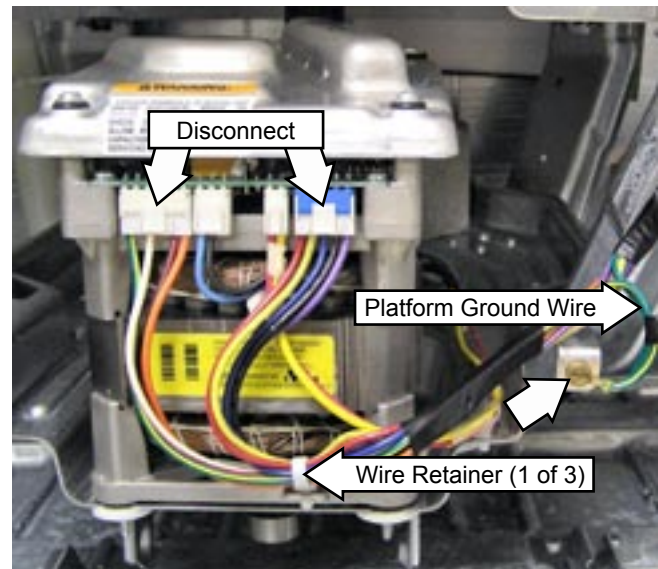

12. Remove the water pressure switch hose from the outer tub.
13. Pinch off the black sump hose to prevent water spills.
14. Loosen the 5/16-in. screw-type hose clamp and remove the sump hose at the tub.

Note: The front and rear rod and spring assemblies have different spring compressions and should not be interchanged. The rods are color-coded to ensure they are replaced in the correct position. Note the color location before removing.

15. Disengage the front rod and spring assemblies by raising the tub and removing the spring assemblies from the platform.



Note: The tub assembly will now lean forward. This allows clearance to reach behind the tub and access the rear rod and spring assemblies.

16. Disengage the rear rod and spring assemblies by raising the rear of the tub and removing the spring assemblies from the platform.
17. Pull the top of the tub assembly toward the front of the cabinet, then remove the basket from the tub.



18. Remove the tub assembly from the cabinet and place it on a protected surface.

Shaft and Mode Shifter Assembly

The shaft and mode shifter assembly consists of the shaft and tube, mode shifter cam, and mode shifter coil. These parts come only as an assembly.

WARNING: Do not attempt to disassemble the shaft and mode shifter assembly.

To remove the shaft and mode shifter assembly:

1. Remove the tub assembly from the cabinet. (See **Tub Assembly**.)
2. Remove the split ring and flat washer from the drive assembly.



Note: A new seal (part number WH02X10032) is included with a replacement tub or shaft and mode shifter assembly. Replace the seal when the tub has been separated from the shaft and mode shifter assembly.

3. Invert the tub assembly on a protected surface and remove the plastic tie that holds the flood hose to the platform.



4. Disconnect the mode shifter coil wire harness from the motor.
5. Release the compression tab that attaches the mode shifter coil wire harness retainer to the front of the platform.



6. Run the belt off the drive pulley and remove the 3/4-in. pulley nut.



Note: When replacing pulley, tighten pulley nut to 275 in. lbs. of torque.

Note: In the following step, after removing the pulley nut, it may be helpful to grab the center core of the drive pulley with one hand and gently tap one of the drive pulley arms with a hammer. The drive pulley will "pop" off the tapered shaft.

7. Remove the drive pulley from the shaft and mode shifter assembly.

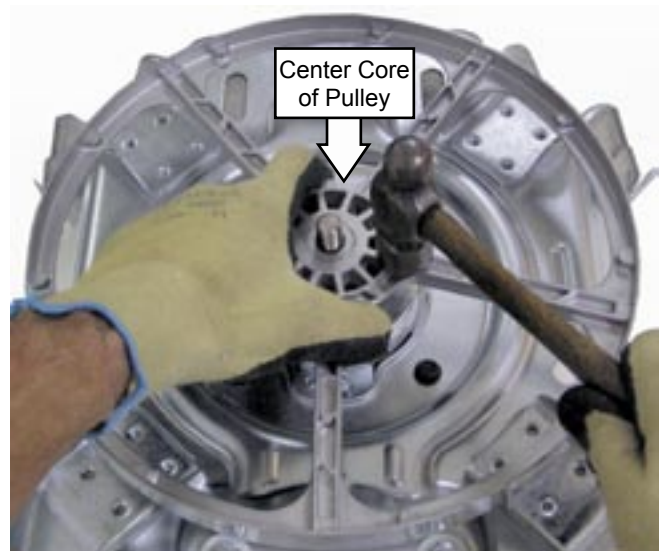

8. Remove the three 3/8-in. hex-head bolts from the bottom of the platform.

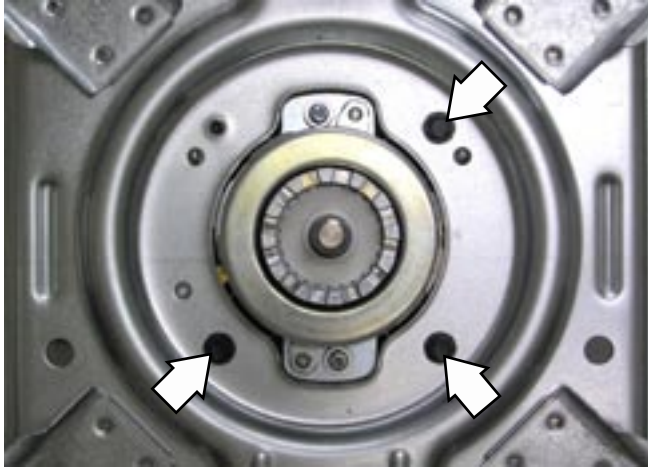

9. Remove the four 1/2-in. hex-head bolts that attach the platform to the tub.



10. Lift the platform from the tub.



11. Place the platform upright on a protected surface and remove the tub bearing washer from the tube.



12. Remove the inverted single $\frac{3}{8}$ -in. hex-head bolt from the top of the platform.

Note: Torque the four $\frac{3}{8}$ -in. hex-head bolts to 90 in. lbs. when reinstalling.

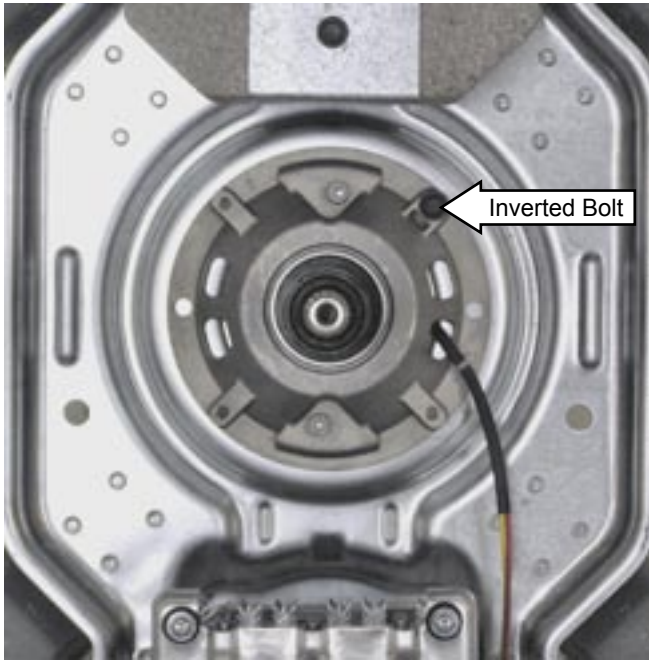

13. Lift the shaft and mode shifter assembly from the platform.

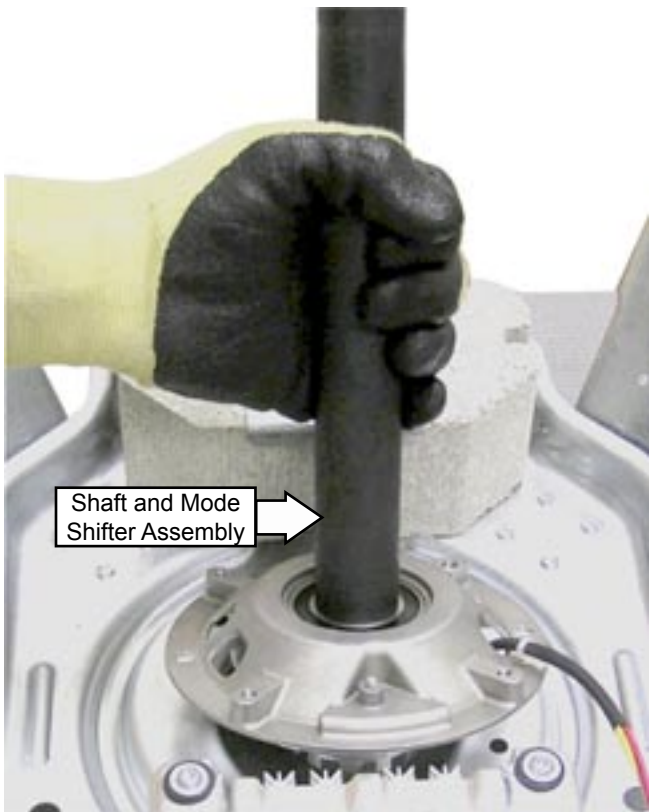

Diagnostics and Service Information

Wash Cycle Time Chart

CYCLE	TIME	CYCLE TIME WITH OPTIONS					
		2ND RINSE	EXT SPIN	AUTO SOAK	AUTO SOAK 2ND RINSE	AUTO SOAK EXT SPIN	
PREWASH	56	69	62	56	69	62	
COTTONS	HEAVY	43	56	51	58	71	66
	MED	37	50	45	52	65	60
	LIGHT	34	47	42	49	62	57
CASUALS	HEAVY	41	54	47	56	69	62
	MED	38	51	44	53	66	59
	LIGHT	35	48	41	50	63	56
EASY CARE	HEAVY	38	51	44	53	66	59
	MED	35	48	41	50	63	56
	LIGHT	32	45	38	47	60	53
HANDWASH	MED	38	51	44	53	66	59
	LIGHT	35	48	41	50	63	56
DELICATES	32	45	38	47	60	53	
SPEEDWASH	25	36	28	40	51	43	
QUICK RINSE	16	29	22	31	44	37	
DRAIN & SPIN	6	6	12	6	6	12	

Entering the Field Service Mode

The washer control has a field service mode that can be utilized by the service technician in order to test critical components and to access error codes. This field service mode will help the service technician to quickly identify failed or improper operation of these components.

To enter the field service mode, press and hold the START/PAUSE button while rotating the Cycle Selector Knob 180° (8 detents on the control), then release the START/PAUSE button.

The field service mode can be entered at any time. The washer power does not have to be cycled before entering service mode.

The starting position of the Cycle Selector Knob will not affect entrance into the field service mode.

Immediately following the release of the START/PAUSE button all LED's will activate. This is Knob Position "0 - Initial" on the field service mode chart. Rotating the Cycle Selector Knob clockwise will result in the washer performing different functions at each position as shown in the chart.

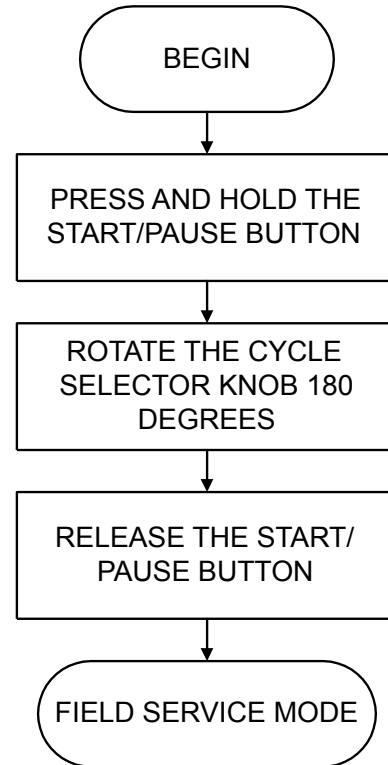

Understanding the Field Service Mode Chart

The field service mode chart contained in the mini-manual (shown at right) is designed for both Profile and GE washers. The Profile washers have a 2-digit display with 3 LEDs. The GE models use 5 LEDs rather than a display to note cycle progression.

The large chart below indicates only those areas of the chart that will be displayed for Profile models.

The display column refers to the 2-digit display (88). The Soak, Wash and Rinse columns refer to the 3 LEDs to the right of the 2-digit display.

The "1" in each column indicates what LED may be lit (Soak, Wash or Rinse).

The "2" in the Rinse column indicates the Rinse LED will be lit while the knob is in position 4-10 if the pressure switch is open.

	DISPLAY	FILL	SOAK	WASH	RINSE	SPIN	
LED NUMBER		0	1	2	3	4	
KNOB POSITION		LED ACTIVE MODE					FUNCTION
0-INITIAL	88	1	1	1	1	1	LED CHECK
1	*	0	0	0	0	0	MODEL CODE
2					1		ERROR CODE - EEPROM
2				1			ERROR CODE THERMISTOR
2			1				ERROR CODE - SLOW PUMP
3					1		ERROR CODE -NO FILL
3				1			ERROR CODE -NO PUMP
3			1				ERROR CODE - PUSH BUTTON
4	H				1	2	HOT WATER VALVE ACTIVE
5	C				1	2	COLD WATER VALVE ACTIVE
6	AL		1			2	SLOW AGITATE (DRY) #
7	AH	1				2	FAST AGITATE (DRY) #
8	P		1			2	PUMP
9	SP			1		2	SPIN
10	3F				1	2	3 Ft Pump Time
10	8F	1	1	1	1	2	8 Ft Pump Time

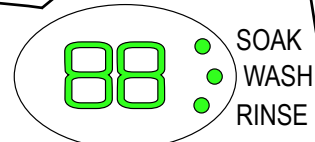

	DISPLAY	SOAK	WASH	RINSE	
LED NUMBER		1	2	3	
KNOB POSITION		LED ACTIVE MODE			FUNCTION
0-INITIAL	88	1	1	1	LED CHECK
1	*				MODEL CODE
2				1	ERROR CODE - EEPROM
2			1		ERROR CODE THERMISTOR
2		1			ERROR CODE - SLOW PUMP
3				1	ERROR CODE -NO FILL
3			1		ERROR CODE -NO PUMP
3		1			ERROR CODE - PUSH BUTTON
4	H			2	HOT WATER VALVE ACTIVE
5	C			2	COLD WATER VALVE ACTIVE
6	AL			2	SLOW AGITATE (DRY) #
7	AH			2	FAST AGITATE (DRY) #
8	P			2	PUMP
9	SP			2	SPIN
10	3F			2	3 Ft Pump Time
10	8F			2	8 Ft Pump Time

- * MODEL DEPENDANT
- 1 LED ON
- # DEPRESS START BUTTON WILL CHANGE DRY TO WET
- 2 LED ON IF TUB FULL (PRESS SW. SATISFIED)

(Continued next page)

Knob Position	Function	Description
Position 0	LED Check	Lights all LEDs on display.
Position 1	Model Code	Factory code setting for main control.
Position 2* (Rinse LED On)	EEPROM Error	Control memory check. Error requires main control replacement.
Position 2* (Wash LED On)	Thermistor Error	At the start of each wash cycle (except in the tap cold temperature setting), the control will check whether the sensor is open or shorted. If open or shorted, the control will complete the wash cycle without relying on temperature feedback. In determining an open or shorted thermistor, the control looks for an out of range reading, which is 10K at the lower limit and 120K at the upper limit.
Position 2* (Soak LED On)	Slow Pump Error	If the pressure switch does not reset (closed/empty tub) within 3 minutes of the control starting the drain pump, the slow pump error will be recorded.
Position 3* (Rinse LED On)	No Fill Error	If the tub takes longer than 20 minutes to fill, the no fill error will be recorded.
Position 3* (Wash LED On)	No Pump Error	If the pump detection circuit indicates no water is being pumped while the pump is energized and the pressure switch is open (water in tub), the no pump error will be recorded. The control uses current amplitude of the drain pump motor to determine whether water is being pumped.
Position 3* (Soak LED On)	Push Button Error	If any button is closed for 1 minute or longer, the push-button error code will be recorded.
Positions 4 - 9	Activates the listed component.	Position 4 = Hot water valve active Position 5 = Cold water valve active Position 6 = Slow agitate (dry)** Position 7 = Fast agitate (dry)** Position 8 = Pump Position 9 = Spin
Position 10	Pump Time	Hold Start/Pause button for 3 seconds to toggle setting. Changing the setting from 3 ft. to 8 ft. adds 30 seconds to the drain pump out time before each spin cycle begins. Default pump out is 3 minutes. Changing to 8ft changes the pump out time to 3 ½ minutes.

NOTE:

* To clear any recorded errors in Positions 2 or 3, press the Start/Pause button while in the appropriate position.

** Depress and hold the Start/Pause button for 3 seconds for wet agitation. Energizes the water valves based on temperature control setting.

Exiting the Field Service Mode

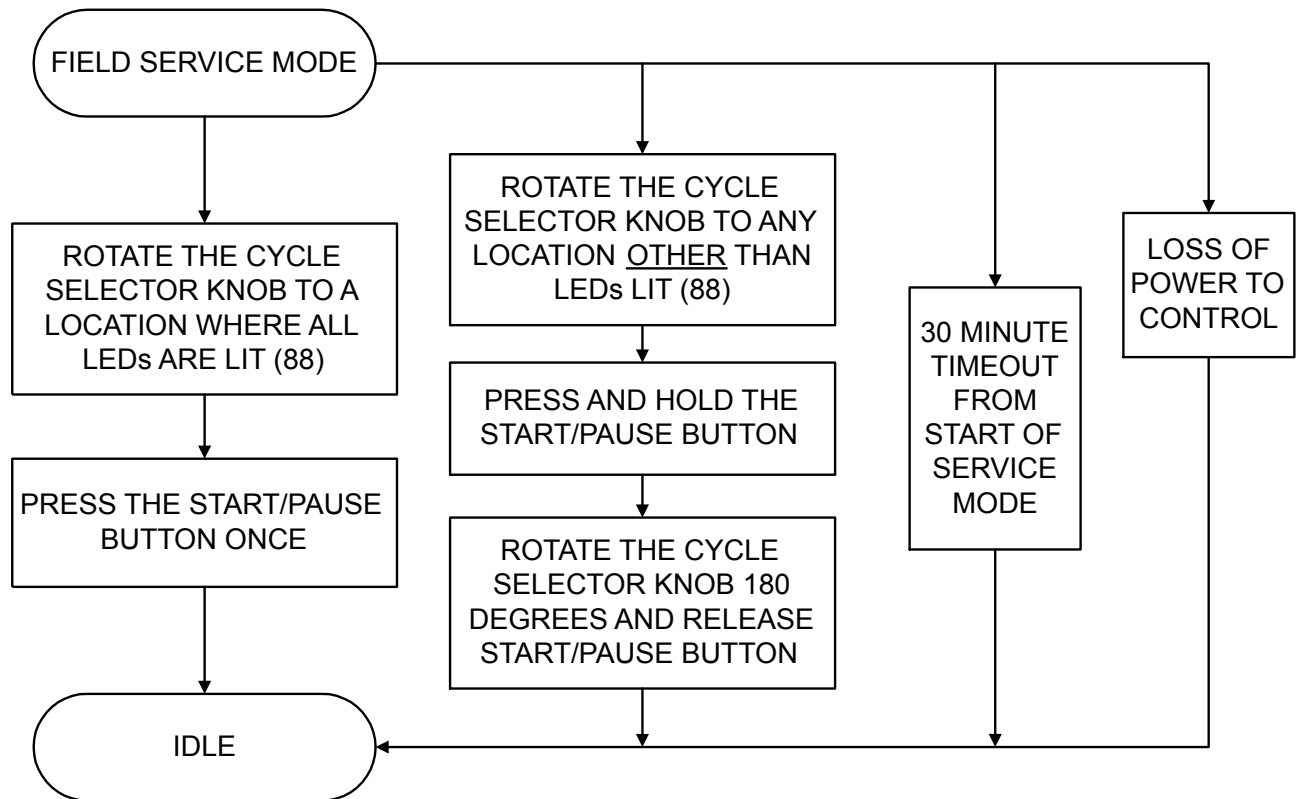

Inverter/Motor Error Codes

Inverter/Motor Signal LED

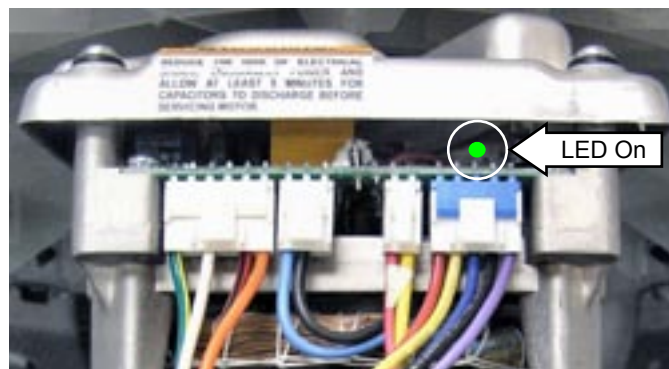

- An LED beneath the inverter cover can be viewed for diagnostic testing.
- When motor is operating normally, and running, the LED blinks at a constant rate of ½ second on and ½ second off.
- When motor is operating normally, and idle, the LED blinks at a constant rate of 1 second on and 1 second off.
- Motor/Control error condition – LED is on for .25 seconds and off for .25 seconds for a specified number of times, during a 6 second period. The 6 second cycle repeats continuously.

(Continued next page)

Inverter/Motor Signal LED Errors

NUMBER OF FLASHES	DESCRIPTION	ACTION
1 SECOND ON 1 SECOND OFF	NORMAL STANDBY	NORMAL STANDBY
.5 SECOND ON .5 SECOND OFF	NORMAL RUNNING	NORMAL RUNNING
1 FLASH	LONG STOP TIME	REPLACE MOTOR
2 FLASH	SLIPPING BELT	CHECK BELT*
3 FLASH	CORRUPTED SOFTWARE	REPLACE MOTOR
4 FLASH	MODE SHIFT CIRCUIT FAILED	CHECK MODE SHIFTER COIL*
5 FLASH	NOT IMPLEMENTED	REPLACE MOTOR
6 FLASH	LOCKED ROTOR	MAKE SURE SYSTEM IS FREE*
7 FLASH	LID SWITCH DID NOT OPEN	CHECK LIDSWITCH*
8 FLASH	MOTOR OVERHEATED	MAKE SURE SYSTEM IS FREE*
9 FLASH	BRAKE RESISTOR OPEN	REPLACE MOTOR
ON 2, 4, 6, 7 & 8 FLASH ERRORS IF NO SYSTEM FAILURES ARE FOUND, REPLACE MOTOR		

- When excessive stop time is encountered, more than 25 seconds, the LED blinks once for ¼ second and then off for the remainder of a 6 second period.
- When a broken coupling or slipping belt is detected, the LED blinks twice at a rate of ¼ second on and ¼ second off for the remainder of a 6 second period.
- When an inverter ROM checksum error is detected, the LED blinks 3 times at a rate of ¼ second on and ¼ second off for the remainder of a 6 second period.
- When a mode shifter error occurs, the LED blinks 4 times at a rate of ¼ second on and ¼ second off for the remainder of a 6 second period. The motor continues to operate with this error.
- When a locked rotor is detected, the washer will sit idle for 15 seconds and retry. If the motor does not operate after 3 tries, the LED blinks 6 times at a rate of ¼ second on and ¼ second off for the remainder of a 6 second period.
- When a lid error is detected by the lid switch counter, 4 agitate/spin pairs with no change in state of lid switch, the LED blinks 7 times at a rate of ¼ second on and ¼ second off for the remainder of a 6 second period.
- When an over temperature condition is detected in motor, the LED blinks 8 times at a rate of ¼ second on and ¼ second off for the remainder of a 6 second period. The motor continues to operate at reduced performance levels.
- When a brake resistor circuit error is detected in motor, the LED blinks 9 times at a rate of ¼ second on and ¼ second off for the remainder of a 6 second period. Maximum spin speed is limited to 50 RPM.
- Critical Errors, #1, #2, & #7, will prevent inverter/motor from operating.

To clear errors, disconnect power until an audible clicking sound is heard when the inverter capacitor discharges (approximately 15 seconds). Open and close the lid 5 or more times in any 12 second period within the first 30 seconds of power-up. Errors will not clear if washer is in either agitate or spin mode.

Inverter/Motor Test

Voltage readings:

C2 Pin 1 = Gnd

C2 Pin 3 = N

C2 Pin 5 to Pin 3 = 120 VAC

C2 Pin 6 to Pin 3 = 120 VAC with lid switch closed

C7 Pin 1 to Pin 2 = 135 VDC**

C7 Pin 1 to Pin 2 = 30 VDC**

C4 Pin 5 to Pin 1 = 9 VDC*

C4 Pin 5 to Pin 2 = 9 VDC*

C4 Pin 5 to Pin 3 = 9 VDC*

C4 Pin 5 to Pin 4 = 9 VDC*

* Place washer in field service mode spin test (Knob Position 9). If 9 VDC is present at specified pins, main control is OK. If motor runs in spin test, inverter, motor and wiring harness are OK.

** 135 VDC is present for approximately 15 seconds at the beginning of the agitate program. 30 VDC is present during the remainder of the agitate cycle.

Note: All electrical testing is done at harness plugs.

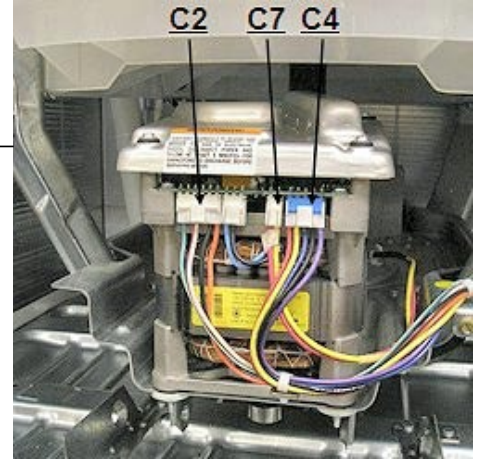
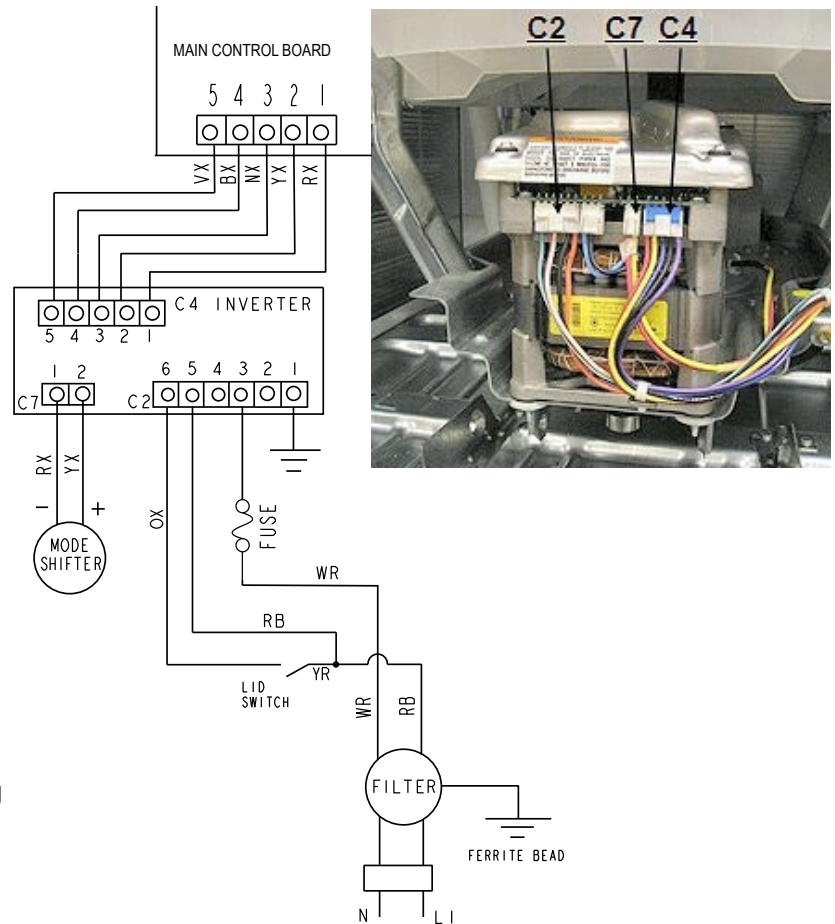

Mode Shifter Coil Test

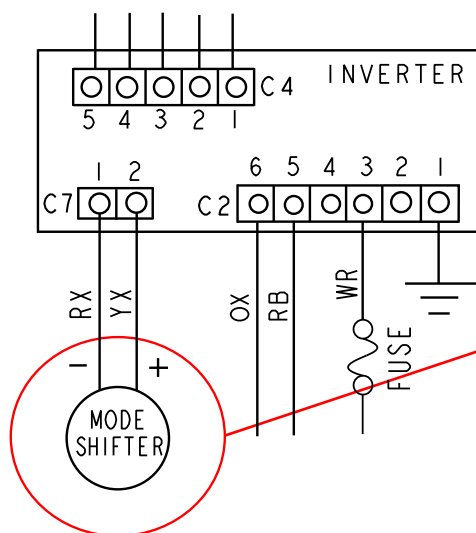

Note: The mode shift coil connects to C7 connector on inverter/motor assembly. Unplug C7 connector and check continuity. Mode shift coil resistance value is approximately 98Ω @ room temperature (77°F).

Brake Test

The brake resistor is permanently molded into the underside of the inverter cover.

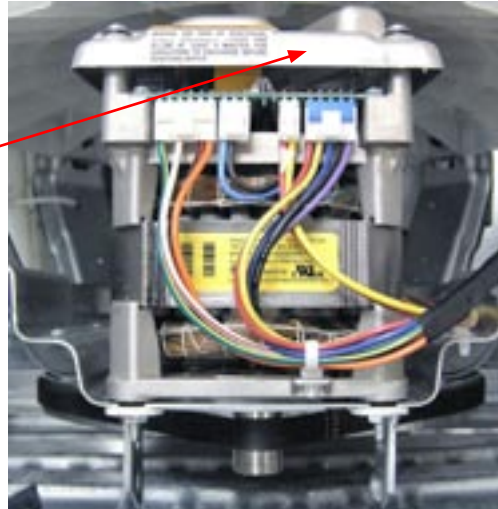

- Tub should stop spinning 7 seconds after lid is lifted.
- If the tub takes approximately 10 seconds to stop, check drive belt for wear.
- If tub coasts to stop, brake resistor has failed and inverter/motor assembly must be replaced.
- If the tub takes longer than 25 seconds to stop, the inverter will initiate a brake resistor error code. (See *Inverter/Motor Error Codes*.)

Schematic

WARNING: Disconnect electrical power before servicing.

Caution: Label all wires prior to disconnection. Wiring errors can cause improper and dangerous operation. Verify operation after servicing.

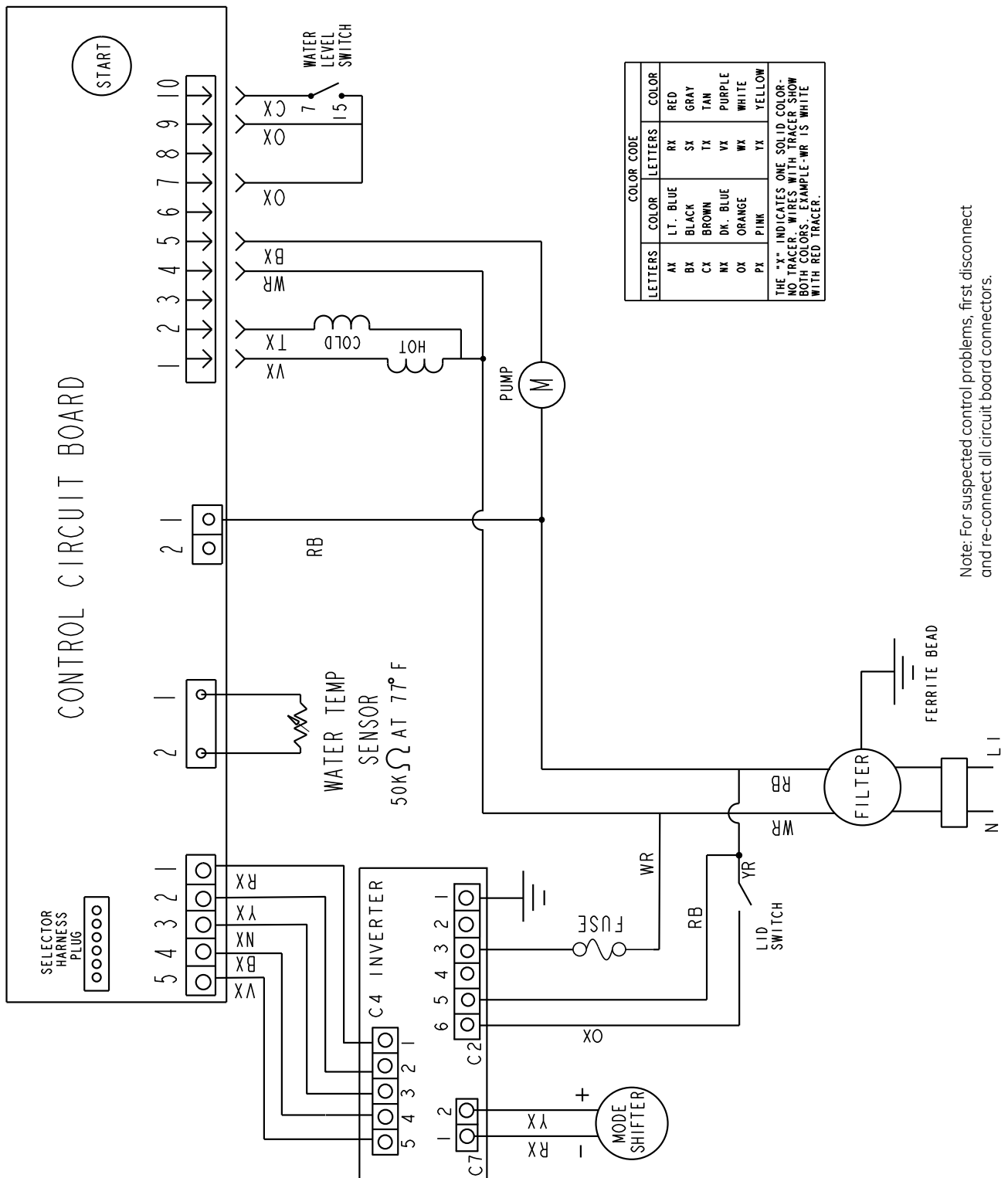

Note: For suspected control problems, first disconnect and re-connect all circuit board connectors.

Warranty

GE Washer Warranty.



All warranty service provided by our Factory Service Centers, or an authorized Customer Care® technician. To schedule service, on-line, 24 hours a day, visit us at ge.com, or call **800.GE.CARES** (800.432.2737). Please have serial number and model number available when calling for service.

For The Period Of: We Will Replace:

One Year From the date of the original purchase	Any part of the washer which fails due to a defect in materials or workmanship. During this limited one-year warranty , GE will also provide, free of charge , all labor and related service costs to replace the defective part.
Second through Fifth Year From the date of the original purchase	The suspension rod and spring assembly, and main electronic control board , if any of these parts should fail due to a defect in materials or workmanship. GE will also replace the washer lid or cover , if they should rust under operating conditions. During this additional four-year limited warranty , you will be responsible for any labor or related service costs.
Second through Tenth Year From the date of the original purchase	The shaft and tube assembly and outer washer tub , if any of these parts should fail due to a defect in materials or workmanship. During this additional nine-year limited warranty , you will be responsible for any labor or related service costs.
Lifetime of Product From the date of the original purchase	The washer basket , if it should fail due to a defect in materials or workmanship. During this product lifetime limited warranty , you will be responsible for any labor or related service costs.

What Is Not Covered:

- Service trips to your home to teach you how to use the product.
- Improper installation, delivery or maintenance.
- Failure of the product if it is abused, misused, or used for other than the intended purpose or used commercially.
- Replacement of house fuses or resetting of circuit breakers.
- Damage to the product caused by accident, fire, floods or acts of God.
- Incidental or consequential damage caused by possible defects with this appliance.
- Damage caused after delivery.
- Product not accessible to provide required service.