



LG Electronics Inc.



Owner's Manual

Washing Machine

WM2277H*
WM2077CW

Please read this manual carefully. It provides instructions on safe installation, use, and maintenance. Retain it for future reference.

Record the model and serial numbers of your machine and report this information to your dealer if your machine requires service.

PRODUCT FEATURES

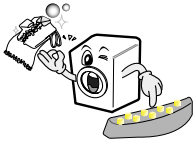
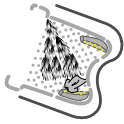
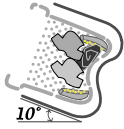

- **Direct Drive System**
The advanced Brushless DC motor directly drives the drum without belt and pulley.
- **Tilted Drum and Extra Large Door Opening**
Tilted drum and extra large opening make it possible to load and unload clothing more easily.
- **Water Circulation (WM2277H*)**
Spray detergent solution and water onto the load over and over. Clothes are soaked more quickly and thoroughly during wash cycle. The detergent suds can be removed more easily by the water shower during rinse cycle. The water circulation system uses both water and detergent more efficiently.
- **RollerJets (WM2277H*)**
Washing ball enhances the wash performance and reduces damage to the clothing. The jets spray and help tumble clothes to enhance washing performance while maintaining fabric care.
- **Automatic Wash Load Detection**
Automatically detects the load and optimizes the washing time.
- **Built-in Heater (WM2277H*)**
Internal heater helps to maintain water temperature at its optimum level for selected cycles.
- **Child Lock**
The Child lock prevents children from pressing any button to change the settings during operation.

CONTENTS

Important Safety Information	3
Specifications.....	4
Installation Instructions	5
Preparation Before Washing.....	10
Using the Dispenser	11
Cycles	13
How to Use the Washer.....	14
Maintenance	17
Troubleshooting Guide	20
Warranty	23

IMPORTANT SAFETY INFORMATION

READ ALL INSTRUCTIONS BEFORE USE

⚠ WARNING!

For your safety, the information in this manual must be followed to minimize the risk of fire or explosion, electric shock, or to prevent property damage, personal injury, or loss of life.

IMPORTANT SAFETY INSTRUCTIONS

⚠ WARNING: To reduce the risk of fire, electric shock, or injury to persons when using the washer, follow basic precautions, including the following:

- *Read all instructions before using the washer.*
- *Do not wash articles that have been previously cleaned in, washed in, soaked in, or spotted with gasoline, dry cleaning solvents, or other flammable or explosive substances, as they give off vapors that could ignite or explode.*
- *Do not add gasoline, dry cleaning solvents, or other flammable or explosive substances to the wash water. These substances give off vapors that could ignite or explode.*
- *Under certain conditions, hydrogen gas may be produced in a hot water system that has not been used for 2 weeks or more. HYDROGEN GAS IS EXPLOSIVE. If the hot water system has not been used for such a period, before using the washing machine, turn on all hot water faucets and let the water flow from each for several minutes. This will release any accumulated hydrogen gas. As the gas is flammable, do not smoke or use an open flame during this time.*
- *Do not allow children to play on or in the washer. Close supervision of children is necessary when the washer is used near children.*
- *Before the washer is removed from service or discarded, remove the door to prevent children from hiding inside.*
- *Do not install or store the washer where it will be exposed to the weather.*
- *Do not tamper with controls.*
- *Do not repair or replace any part of the washer or attempt any servicing unless specifically recommended in the user-maintenance instructions or published user-repair instructions that you understand and have the skills to carry out.*
- *See Installation Instructions for grounding requirements.*
- *ALWAYS follow the fabric care instructions supplied by the garment manufacturer.*
- *Do not place items exposed to cooking oil in your washer. Items contaminated with cooking oils may contribute to a chemical reaction that could cause a load to catch fire.*
- *Do not use fabric softeners or products to eliminate static unless recommended by the manufacturer of the fabric softener or product.*

SAVE THESE INSTRUCTIONS

GROUNDING INSTRUCTIONS

This appliance must be grounded. In the event of malfunction or breakdown, grounding will reduce the risk of electric shock by providing a path of least resistance for electric current. This appliance is equipped with a cord having an equipment-grounding conductor and grounding plug. The plug must be plugged into an appropriate outlet that is properly installed and grounded in accordance with all local codes and ordinances.

- *Do not use an adapter or extension cord.*
- *Do not remove ground prong.*
- *If you don't have the proper outlet, consult an electrician.*

⚠ WARNING: Improper connection of the equipment-grounding conductor can result in risk of electric shock.

Check with a qualified electrician or serviceman if you are in doubt as to whether the appliance is properly grounded. Do not modify the plug provided with the appliance - if it does not fit the outlet, have a proper outlet installed by a qualified electrician.

SPECIFICATIONS

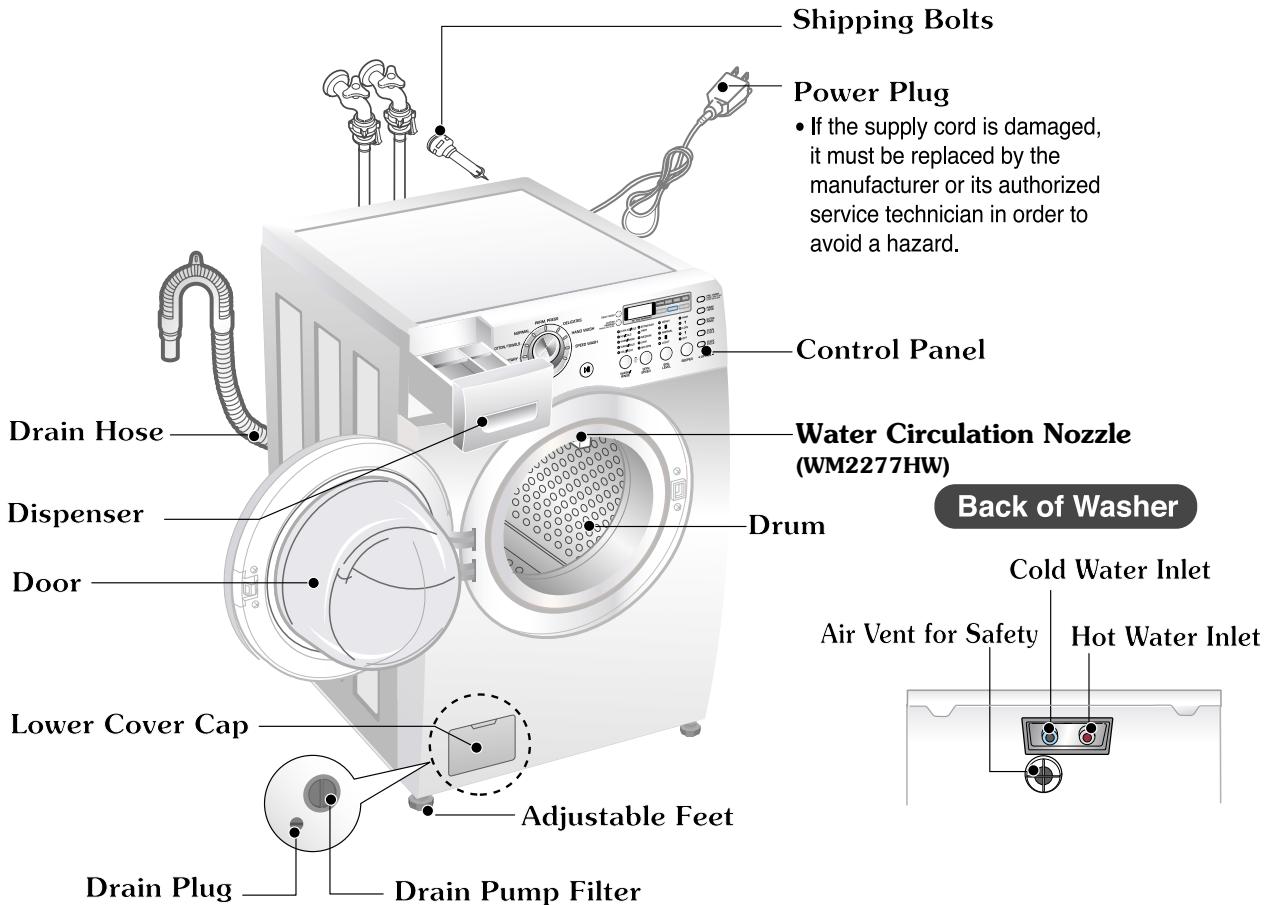

Shipping Bolts

Power Plug

- If the supply cord is damaged, it must be replaced by the manufacturer or its authorized service technician in order to avoid a hazard.

Back of Washer

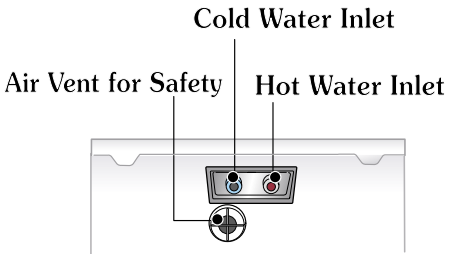

- Name: Front-loading Washing Machine
- Power supply: 120V~ 60Hz
- Size: 68.6 cm (W) X 75.6 cm (D) X 98.3 cm (H), 129.1 cm (D, door open)
27" (W) X 29³/₄" (D) X 38¹¹/₁₆" (H), 50¹³/₁₆" (D, door open)
- Weight: 190 lbs. (86 kg)
- Wash capacity: 3.22 cu. ft. (IEC: 3.72 cu. ft.)¹⁾
- Spin speed: 1100 rpm max. (WM2277H*)
1000 rpm max. (WM2077CW)
- Permissible water pressure: 4.5 ~ 145 PSI (30 ~ 1000 kPa)

* Specifications subject to change by manufacturer.

■ Accessories

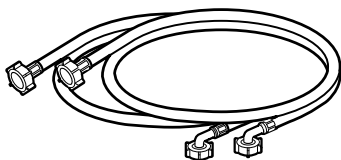

Hot/Cold (1 each)
Hose

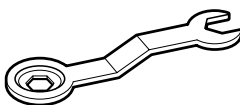

Wrench

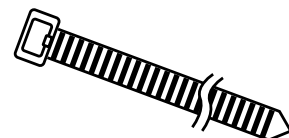

Tie strap
to secure drain hose to standpipe,
inlet hose, or laundry tub

1) Per IEC 60456, washes the equivalent of a 3.72 cu. ft. agitator washer.

INSTALLATION INSTRUCTIONS

Install or store unit where it will not be exposed to temperatures below freezing or exposed to outside weather conditions.

Properly ground washer to conform with all governing codes and ordinances.

To reduce the risk of electric shock, do not install the washer in humid spaces.

The base opening must not be obstructed by carpeting when the washing machine is installed on a carpeted floor.

In countries where there are areas which may be subject to infestation by cockroaches or other vermin, pay particular attention to keeping the appliance and its surroundings in clean condition at all times.

Damage caused by cockroaches or other vermin will not be covered by the appliance warranty.

■ Shipping bolts

The appliance is fitted with shipping bolts to prevent internal damage during transport.

■ Removing shipping bolts

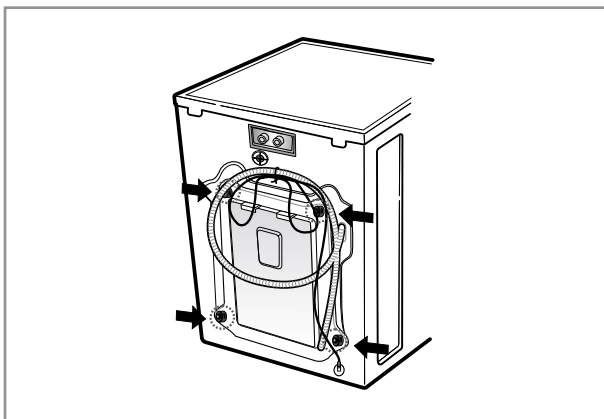

1. To prevent internal damage during transport, 4 locking bolts are installed. Before operating the washer, remove the bolts and braces.

• If they are not removed, it may cause severe vibration, noise, and malfunction.

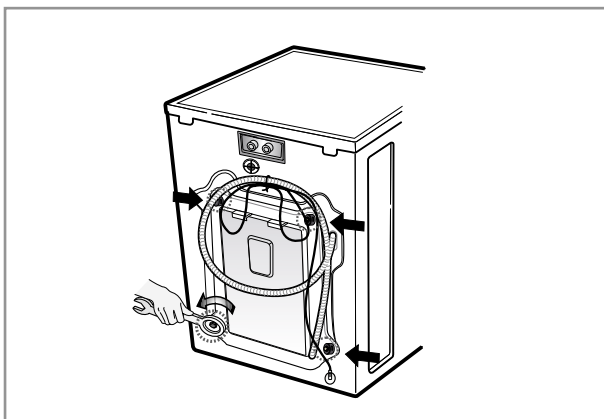

2. Unscrew the 4 bolts with the wrench supplied.

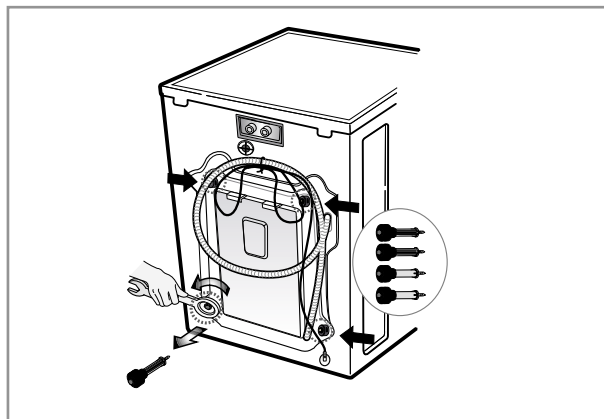

3. Take out the 4 bolts and braces by twisting the braces slightly. Keep the 4 bolts, braces and the wrench for future use.

• Whenever the appliance is transported, the shipping bolts and braces must be replaced.

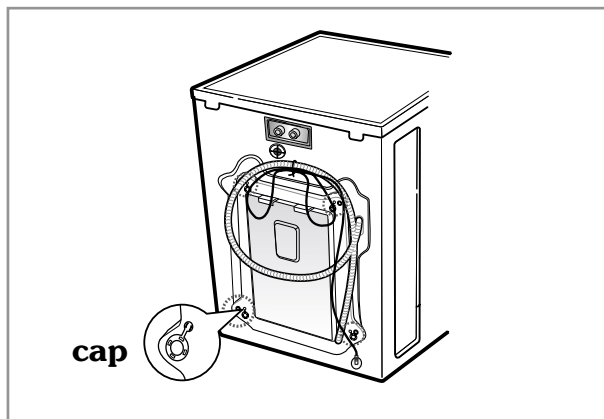

4. Close the holes with the caps supplied.

INSTALLATION INSTRUCTIONS

■ Installation clearances

The location must be large enough to fully open the washer door.

■ Washer dimensions

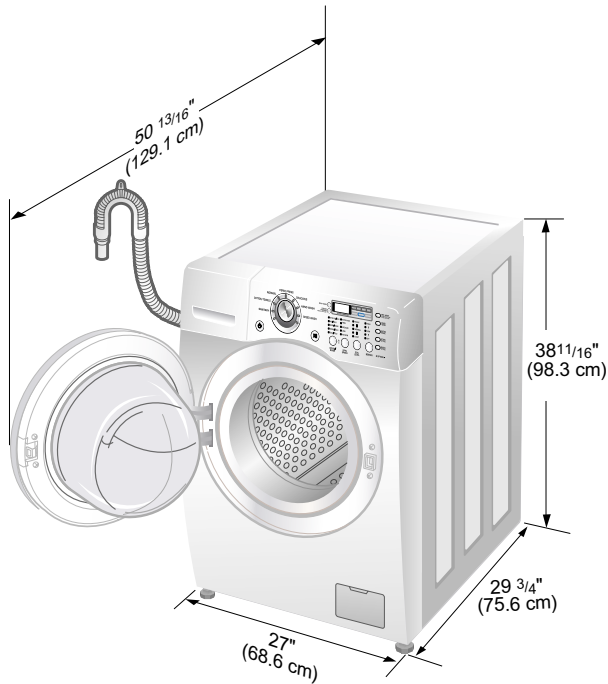

[Side view]

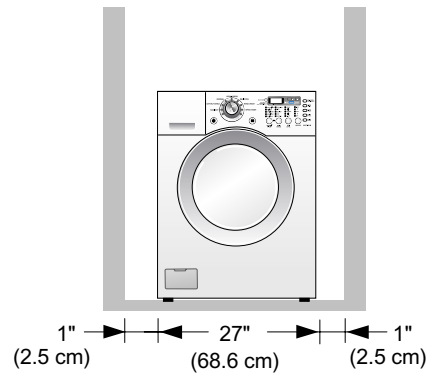

[Front view]

- Most installations require a minimum 4 in. (10 cm) clearance behind the washer.

■ Minimum installation spacing for recessed area installation.

The following dimensions shown are for the minimum spacing allowed.

Additional spacing should be considered for installation and servicing.

- Additional clearances might be required for wall, door and floor moldings.
- Additional spacing of 1 in. (2.5 cm) on all sides of the washer is recommended to reduce noise transfer.

Companion appliance spacing should also be considered.

■ Level floor

- Allowable slope under entire washer is 1°.
- **To minimize noise and vibration, the washer MUST be installed on a solidly constructed floor.**
- Wood floors may need to be reinforced to reduce noise and vibration.
- Carpeting and soft tile surfaces are not recommended.
- Never install the washer on a platform or weakly supported structure.

■ Power outlet

Must be within 60 in. (1.5 m) of either side of the washer. Do not overload the outlet with more than one appliance.

INSTALLATION INSTRUCTIONS

■ Electrical connection

- Do not use an extension cord or double adapter.
- If the supply cord is damaged, it must be replaced by a qualified person in order to avoid a hazard.
- If the machine will not be used for an extended time, unplug it and shut off the water supply.
- Connect the machine to a grounded outlet in accordance with current wiring regulations.
- The appliance must be positioned so that the plug is easily accessible.

■ Connecting water supply hose

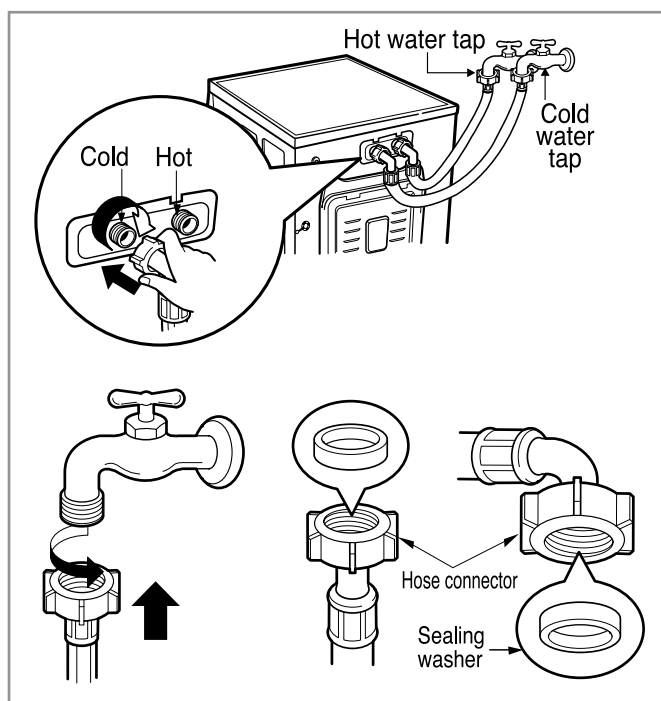

- Water supply pressure must be between 4.5 ~ 145 PSI (30~1000 kPa)
- Do not cross-thread when connecting inlet hose to the valve.
- If the water supply pressure is more than 145 PSI, a pressure reducing device should be installed.
- Two Sealing washers are supplied with the water inlet hoses to prevent water leaks.
- Check for leakage of washing machine connections by turning the tap completely on.
- Periodically check the condition of the hose and replace the hose if necessary.
- Make sure that there is no kink in the hose and that it is not crushed.
- Be sure that the two water input ports are connected to the correct water faucets. The connector for hot water is colored red.

NOTE: Washing Machine is to be connected to the water mains using new hoses.
Old hoses should not be used.

Repairs to the washing machine must only be carried out qualified personnel. Repairs carried out by inexperienced persons may cause injury or serious malfunctioning. Contact your local service center.

Do not install your washing machine in rooms where temperatures below freezing may occur.
Frozen hoses may burst under pressure. The reliability of the electronic control unit may be impaired at temperatures below the freezing point.

If the appliance is delivered in the winter months and temperatures are below freezing.
Store the washing machine at room temperature for a few hours before putting it into operation.

INSTALLATION INSTRUCTIONS

■ Installation of drain hose

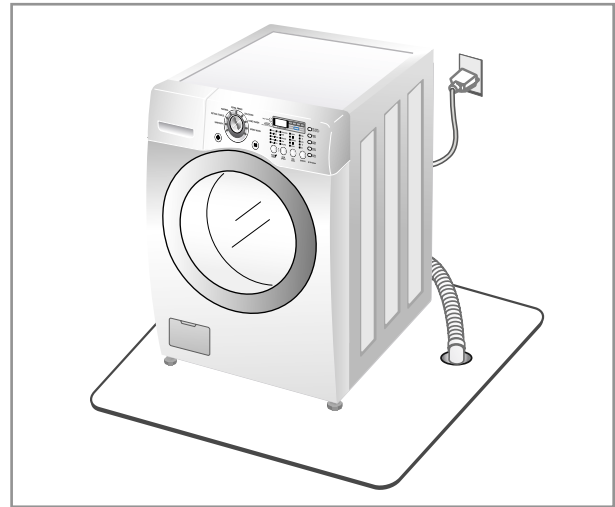
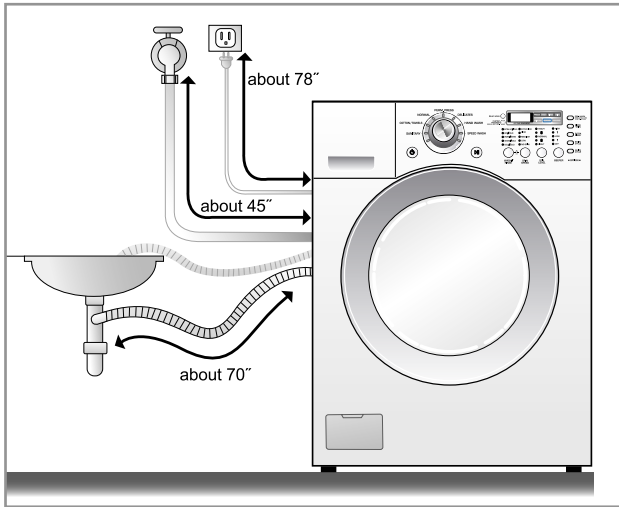

- Place the end of the drain hose in the hole of the floor drain system.

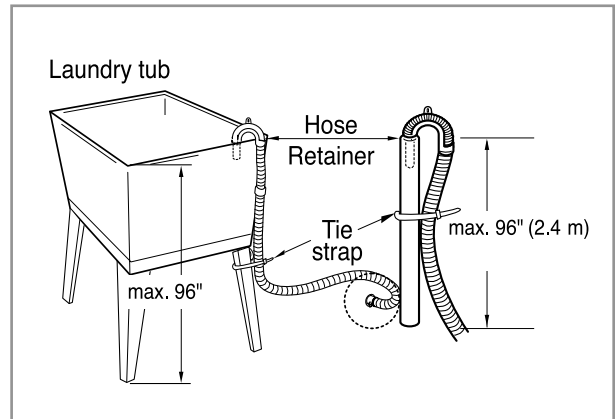
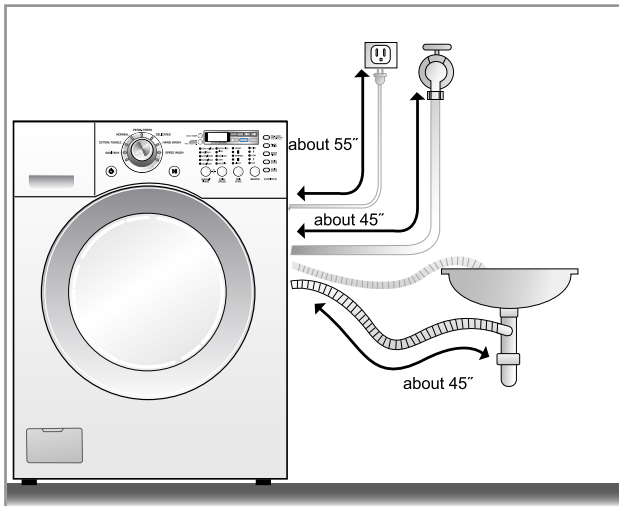

- The drain hose should not be placed higher than 96 in. from the bottom of the washer.
- Properly securing the drain hose will protect the floor from damage due to water leakage.

- When installing the drain hose at a sink, secure it so it cannot break away and cause flooding and damage.
- Properly securing the drain hose will protect the floor from damage due to water leakage.

This equipment is not designed for maritime use or for mobile installations such as in RV's, aircraft, etc.

Turn off the faucet if the machine is to be left for an extended period of time (e.g. holiday).

When disposing of the appliance, cut off the power cable, and destroy the plug.

Disable the door lock to prevent young children being trapped inside.

Packaging material (e.g. Films, Styrofoam) can be dangerous for children. There is a risk of suffocation! Keep all packaging from children.

INSTALLATION INSTRUCTIONS

■ Level adjustment



- Leveling the washing machine properly prevents excessive noise and vibration. Install the appliance on a solid and level floor surface, preferably in a corner of the room.

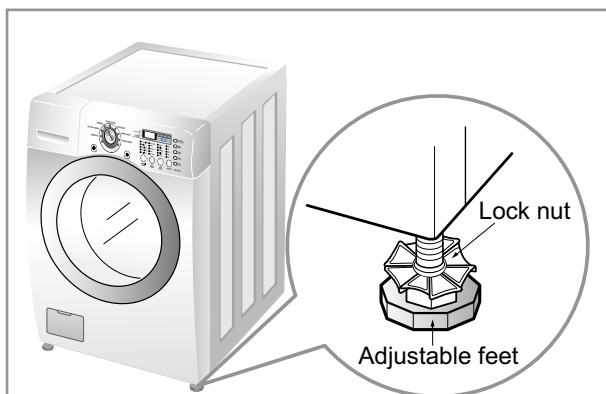

- If the floor is uneven, adjust the adjustable feet as required. (Do not insert pieces of wood, etc. under the feet.)
- Make sure that all four feet are stable and resting on the floor and then check that the appliance is perfectly level. (Use a leveling tool.)
- After the washer is level, tighten the lock nuts up against of the base of the washer. All lock nuts must be tightened.

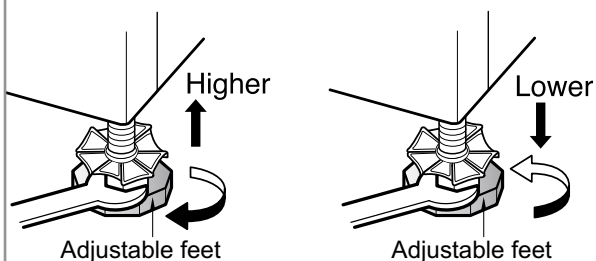

* Diagonal Check

When pushing down the edges of the washing machine top plate diagonally, the machine should not move up and down at all. (Please, check both directions.)

If the machine rocks when pushing the machine top plate diagonally, adjust the feet again.

PREPARATION BEFORE WASHING

WARNING

To reduce the risk of fire, electric shock, or injury to persons, read the **IMPORTANT SAFETY INSTRUCTIONS** before operating this appliance.

1. Fabric Care Labels

Look for a care label on your clothes. This will tell you about the fabric content of your garment and how it should be washed.

2. Sorting

To get the best results, sort clothes into loads that can be washed with the same wash cycle. Different fabrics need to be washed in different ways.

Always sort dark colors from pale colors and whites. Wash separately as dye and lint transfer can occur causing discoloration of white clothing. If possible, do not wash heavily soiled items with lightly soiled ones.

Soil (Heavy, Normal, Light)	Separate clothes according to amount of soil.
Color (White, Lights, Darks)	Separate white fabrics from colored fabrics.
Lint (Lint Producers, Collectors)	Wash lint producers and lint collectors separately.

3. Check before loading

Combine large and small items in a load. Load large items first.

Large items should not be more than half the total wash load.

Do not wash single items. This may cause an out-of-balance load. Add one or two similar items.

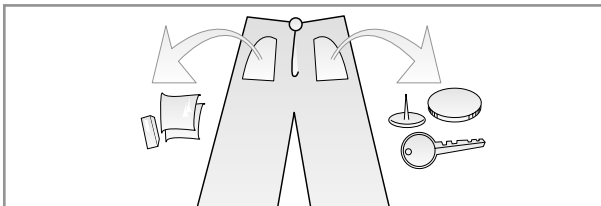

- Check all the pockets to make sure that they are empty. Things such as clip, matches, pens, coins, and keys can damage both your washer and your clothes.

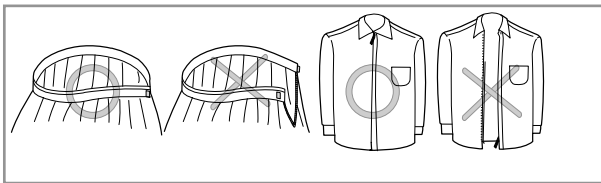

- Close zippers, hooks, and strings to make sure that these items do not snag on other clothes.

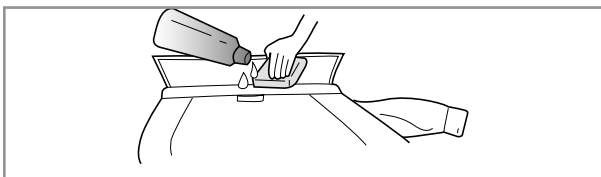

- Pretreat dirt and stains by brushing a little detergent dissolved in water onto stains like collars and cuffs to help lift dirt.

NOTE: Do not wash or spin water-proof clothes.

USING THE DISPENSER

The automatic dispenser consists of four compartments which hold 1) liquid chlorine bleach, 2) liquid fabric softener, 3) liquid or powdered detergent for prewash and 4) liquid or powdered detergent and color safe bleach for main wash.

All laundry products can be added at once in their respective dispenser compartments.

They will be dispensed at the appropriate time for most effective cleaning. After loading the laundry additives into the dispenser, close the dispenser drawer.

Add detergent, bleach and fabric softener to the automatic dispenser following these steps:

1. Open the dispenser drawer.
2. Load the laundry products into the appropriate compartments.
3. Close the dispenser drawer.

■ About detergent

Low sudsing detergent is recommended for this washer. Use the manufacturer's recommended amount.

If low sudsing detergent is not available, a reduced amount of regular detergent may be used.

Because reducing the amount of detergent may reduce cleaning, it is important to pretreat stains, sort carefully by color and soil level, and avoid overloading.

Detergent usage may need to be adjusted for water temperature, water hardness, size and soil level of the load.

For best results, avoid using too much detergent.

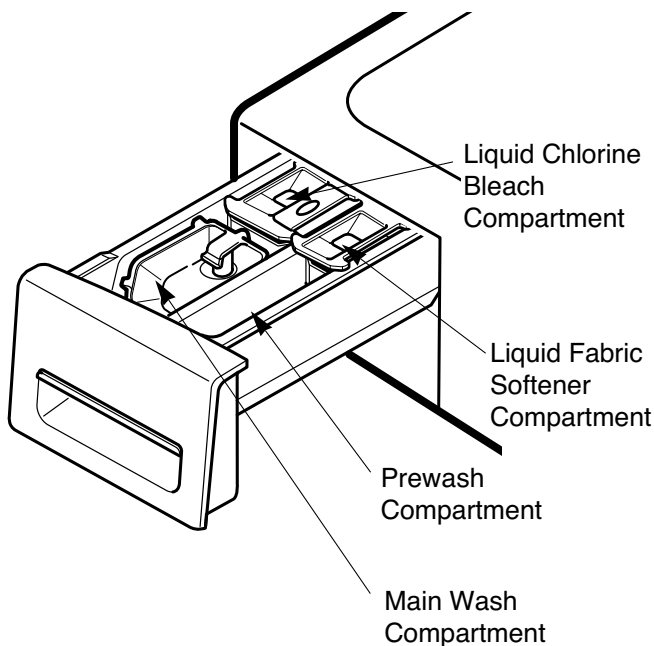

1. Prewash Detergent Compartment

- Add detergent to this compartment when using the Prewash option. Liquid or powdered detergent may be used in this compartment. The detergent will automatically be dispensed during Prewash if the Prewash option is selected.
- Add 1/2 the recommended amount of detergent to the Prewash compartment and the recommended amount of detergent to the main wash compartment.

NOTE : Liquid detergent will drain into the washer drum as it is added.

USING THE DISPENSER

2. Main Wash Detergent Compartment

- Add measured detergent to this compartment for Main wash. Detergent is flushed from the dispenser at the beginning of the cycle. Either powdered or liquid detergent can be used.
- Liquid or powdered color-safe bleach may be added to the main wash compartment along with the same type of liquid or powdered detergent.
- When using liquid detergent, make sure the liquid detergent box and insert are in place. Do not exceed the maximum fill line.
- For powdered detergent, remove both the liquid detergent box and insert.
- Powdered detergent will not dispense with the liquid detergent box and insert in place.

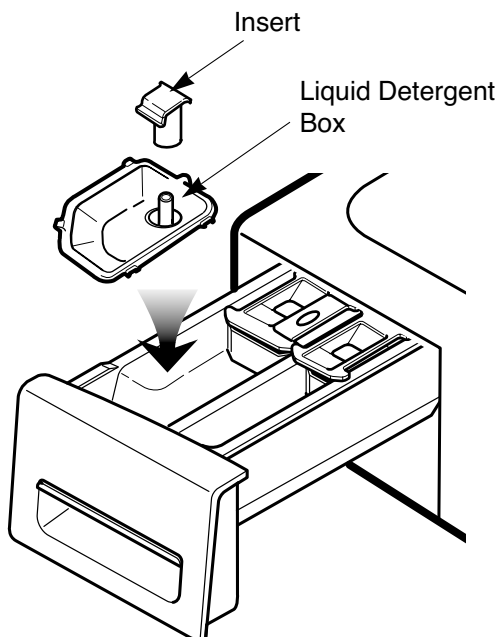

3. Liquid Bleach Compartment

- Add measured liquid chlorine bleach to this compartment. The bleach will be automatically dispensed at the proper time during the wash cycle.
- Do not exceed the maximum fill line. Overfilling can cause early dispensing of the bleach which could result in damaged clothes.
- Do not pour undiluted liquid chlorine bleach directly onto the load or into the drum. Fabric damage can occur.
- Do not use powdered bleach in this compartment.

4. Fabric Softener Compartment

- Add recommended amount of fabric softener to this compartment.
- Dilute concentrated softeners with warm water to the fill line.
- Do not exceed the maximum fill line. Overfilling can cause early dispensing of the fabric softener which could result in stained clothes.
- Do not pour fabric softener directly on the wash load.
- The fabric softener will be automatically dispensed during the last rinse cycle.

CYCLES

■ Select cycles designed for different types of fabric and soil levels.

■ WM2077CW

Cycle	Fabric type	Wash/Rinse Temp.	Spin speed	Soil Level	Pre-Wash	Quick Cycle	Stain Cycle	Extra Rinse	Rinse+ Spin	Auto-Load Detection ¹⁾
Cotton/ Towels	Cotton, linen, towels, shirts, sheets	Warm/Cold	Extra high	Normal						
		Warm/Warm Hot/Cold Tap Cold/Cold Cold/Cold	No spin Low Medium High	Heavy Light	○	○	○	○	○	○
Normal	Mixed loads, work clothes, jeans, shirts	Warm/Cold	High	Normal						
		Warm/Warm Hot/Cold Tap Cold/Cold Cold/Cold	Extra high No spin Low Medium	Heavy Light	○	○	○	○	○	○
Perm Press	Dress shirts/pants, wrinkle free clothing, poly/cotton blend clothing, table cloths	Warm/Cold	Medium	Normal						
		Warm/Warm Hot/Cold Tap Cold/Cold Cold/Cold	High No spin Low	Heavy Light	○	○	○	○	○	○
Delicates	Dress shirts/blouses, nylons, sheer or lacy garment	Cold/Cold	Medium	Normal						
		Warm/Cold Warm/Warm Tap Cold/Cold	No spin Low	Heavy Light	○	○	○	○	○	○
Wool/ Silk	Woolens, silk identified as machine washable	Cold/Cold	Low	Normal						
		Warm/Cold Warm/Warm Tap Cold/Cold	Medium No spin	Light						
Hand Wash	Items labeled "hand washable"	Cold/Cold	Low	Normal						
		Warm/Cold Warm/Warm Tap Cold/Cold	Medium No spin	Light	○	○	○	○	○	○
Speed Wash	Lightly soiled clothing	Hot/Cold	Extra high	Light						
		Tap Cold/Cold Cold/Cold Warm/Cold Warm/Warm	No spin Low Medium High	Normal Heavy						○

■ WM2277H*

Cycle	Fabric type	Wash/Rinse Temp.	Spin speed	Soil Level	Pre-Wash	Quick Cycle	Stain Cycle	Extra Rinse	Rinse+ Spin	Auto-Load Detection ¹⁾
Sanitary	Heavily soiled underwear, work clothes, diapers, etc.	Extra Hot/Cold	Extra High	Normal						
			No spin Low Medium High	Heavy Light	○	○	○	○	○	○
Cotton/ Towels	Cotton, linen, towels, shirts, sheets	Warm/Cold	Extra High	Normal						
		Warm/Warm Hot/Cold Cold/Cold	No spin Low Medium High	Heavy Light	○	○	○	○	○	○
Normal	Mixed loads, work clothes, jeans, shirts	Warm/Cold	High	Normal						
		Warm/Warm Hot/Cold Cold/Cold	Extra High No spin Low Medium	Heavy Light	○	○	○	○	○	○
Perm Press	Dress shirts/pants, wrinkle free clothing, poly/cotton blend clothing, table cloths	Warm/Cold	Medium	Normal						
		Warm/Warm Hot/Cold Cold/Cold	High No spin Low	Heavy Light	○	○	○	○	○	○
Delicates	Dress shirts/blouses, nylons, sheer or lacy garment	Cold/Cold	Medium	Normal						
		Warm/Cold Warm/Warm	No spin Low	Heavy Light	○	○	○	○	○	○
Hand Wash	Items labeled "hand washable"	Cold/Cold	Low	Normal						
		Warm/Cold Warm/Warm	Medium No spin	Light	○	○	○	○	○	○
Speed Wash	Lightly soiled clothing	Hot/Cold	Extra High	Light						
		Cold/Cold Warm/Cold Warm/Warm	No spin Low Medium High	Normal Heavy						○

1) Automatic wash load (weight) detection: Automatically detects the load and optimizes the washing time. After detecting, the estimated time remaining in the cycle will be displayed.

HOW TO USE THE WASHER

■ WM2277H*



■ WM2077CW



1. Power

- Use this button to turn the Power **On/Off**.

2. Cycles

- Rotate the **Cycle selector knob** to select cycle designed for different types of fabric and soil levels.
- Each cycle has a preset Water Temperature, Spin Speed, Soil Level, and Option (See page 13).
- The preset settings can be changed anytime before Start.

3. Start/Pause

- Use this button to **start/stop** the washer.

4. Delay Wash

- Allows the start of any cycle to be delayed for 1~12 (9) hours.
- Choose the wash cycle for your load, and then press the Delay Wash button once for one hour or press the button again to increase the delay wash time up to 12 (9) hours in one hour increments.

HOW TO USE THE WASHER

5. Custom Program

- Custom Program allows you to store a customized wash cycle for future use.
- **To make a Custom Program:**
 1. Select a cycle.
 2. Select **Wash/Rinse Temperature, Spin Speed, and Soil Level.**
 3. Select other desired Options.
 4. Press and hold Custom Program button 3 seconds (2 beep sounds).
The Custom program is now stored for future use. To reuse the program, select Custom Program and press **Start/Pause** .



6. Wash/Rinse Temperature

- Select a water temperature based on the type of load you are washing.
- Follow the fabric care label and chart below for best results.

Suggested Wash Temp.	Garment
Extra Hot 167°F (75°C)	Kitchen towels, sheets, and baby garments
Hot 122°F (50°C)	
Warm 104°F (40°C)	Whites and Heavy soiled color-fast items
Cold 77°F (25°C)	Most loads
	Brightly colored items, washable woolens

- Warm rinses leave the loads dryer than cold rinses. Warm rinses increase wrinkling.
- In cold climates, a warm rinse makes the load more comfortable to handle.
- Cold rinses save energy.
- The Cold rinse temperatures depend on the cold water at your faucet.
- Warm rinses are regulated at approximately 86°F (30°C).
- For the Tap Cold/Cold setting, both wash and rinse temperatures depend on the cold water at your faucet.

7. Spin speed

- To change the spin speed, press the Spin Speed button repeatedly to cycle through available options.
- To start Drain/Spin cycle:
 1. Press Power  button to turn on.
 2. Press Spin Speed button only.
 3. Press Start/Pause  button.

8. Soil Level

- To change the soil level, press the **Soil Level** button repeatedly until the desired setting is on.

9. Beeper

- Press repeatedly to adjust the volume of the Beeper.

HOW TO USE THE WASHER

OPTION

1. Prewash

- Use this option for loads that need pretreatment. Adds 16 minutes prewash and drain.

2. Rinse+Spin

- Use this option to rinse and then spin.

3. Extra Rinse

- This option provides an additional rinse.
- Use this option to ensure the removal of detergent or bleach residue from garments.

4. Stain cycle

- Adds time to the wash and rinse for better stain removal.
- Automatically provides a rinse.

5. Quick Cycle

- The Quick cycle offers a quick cycle time.
- Suggested uses include freshening newly purchased clothes, or clothing that has been packed away.

EST. TIME REMAINING

- This display shows:
 - a) the estimated time remaining in the cycle when operating,
 - b) the error code when an error has been detected.

STATUS INDICATOR

- These lights show which portion of the cycle the washer is operating.

CHILD LOCK

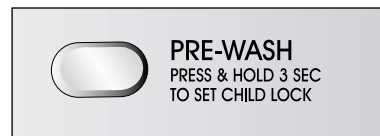

- Use this option to prevent unwanted use of the washer. Press and hold PRE WASH button for 3 seconds to lock/unlock control.
- When Child lock is set, CHILD LOCK lights and all buttons are disabled except the Power (Ⓢ) button. You can lock the washer while it is operating.

DOOR LOCKED

- Lights whenever the door of the washer is locked.
- The door can be unlocked by pressing the Start/Pause (⏸) button to stop the washer.

NOTE: If the water temperature or the level is too high, the door cannot be unlocked. Do not try to force the door open when DOOR LOCKED lights on.

MAINTENANCE

Before cleaning the washer interior, unplug the electrical power cord to avoid electrical shock hazards. When disposing of the appliance, cut off the power cable, destroy the plug, and disable the door lock to prevent young children from being trapped inside.

■ The water inlet filter

- " E " error message will blink on the control panel when water does not enter the dispenser.
- If your water is very hard or contains traces of lime deposit, the water inlet filter may become clogged. We recommend cleaning it every few months.

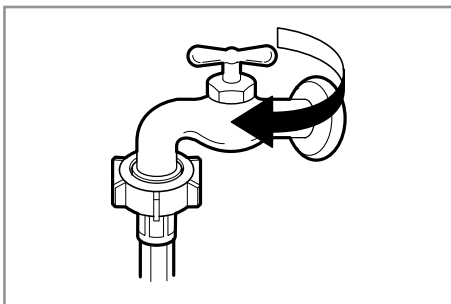

1. Turn off the water tap.

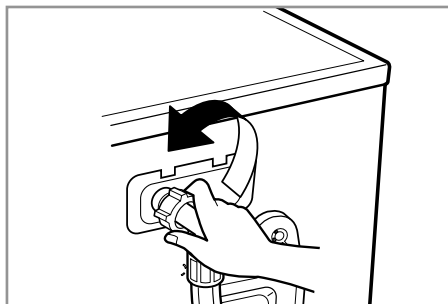

2. Unscrew the water inlet hose.

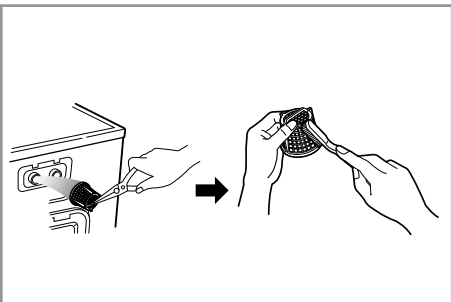

3. Clean the filter using a hard bristle brush.

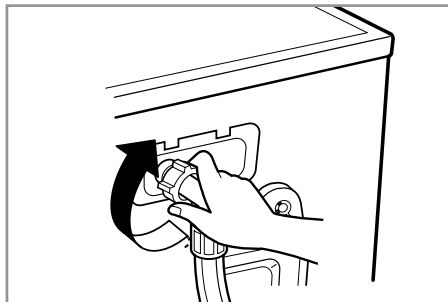

4. Tighten the inlet hose.

■ The drain pump filter

- The drain filter collects threads and small objects left in the laundry. Check regularly that the filter is clean to ensure smooth running of your machine.

CAUTION

Drain, using the drain hose, before opening the pump filter to remove objects. Be careful when draining if the water is hot.

- Allow the water to cool down before cleaning the drain pump filter.

1. Open the lower cover cap ① with a tool such as coin. Turn the drain plug ② to pull out the hose.

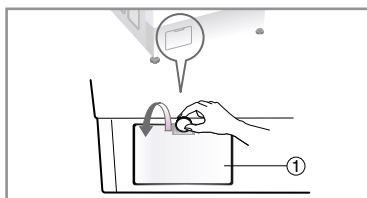

2. Unplug the drain plug ②, allowing the water to flow out. At this time use a vessel to prevent water from flowing onto the floor. When water does not flow any more, turn the pump filter ③ open to the left.

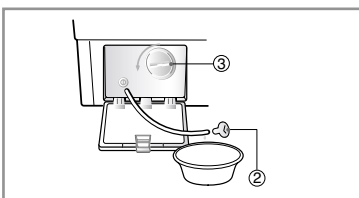

3. Remove any foreign objects from the pump filter ③. After cleaning, turn the pump filter ③ clockwise and insert the drain plug ② to the original place. Close the lower cover cap ①.

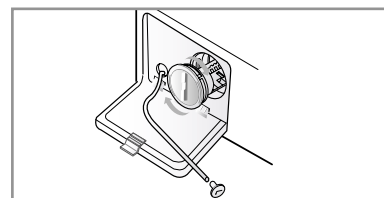

MAINTENANCE

■ Cleaning the Dispenser

- The dispenser may need to be cleaned periodically due to laundry additive build-up.

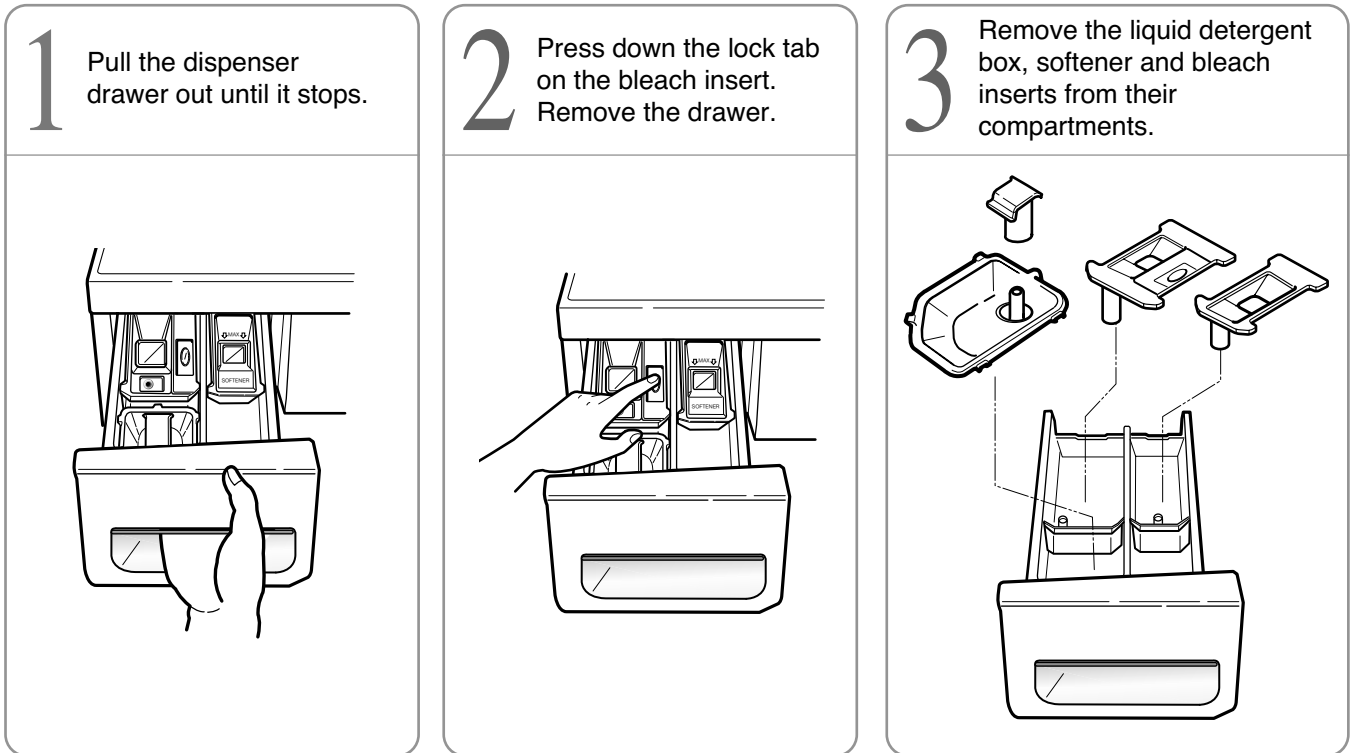

- Run warm water and a soft brush or cloth over the drawer, liquid detergent box and inserts to remove any excess laundry additives.
- Clean the drawer opening using water and a small brush.
- Follow the illustrations in reverse order to replace the parts to their proper location.

NOTE: Do not use any cleaning substance on the drawer opening other than water because it will drain into the tub. If this should happen, set the washer for a rinse and spin cycle to remove any cleaning substance from the washer before doing a load of laundry.

■ The washing drum

- If you live in a hard water area, lime scale can continuously build up in places where it cannot be seen and it is not easily removed from the drum. Over time the build-up of scale clogs appliances, and if it is not kept in check, these will eventually have to be replaced.
- Although the washing drum is made of Stainless steel, specks of rust can be caused by small metal articles (paper clips, safety pins, etc.) which have been left in the drum.
- The washing drum should be cleaned from time to time.
- If you use descaling agents, dyes, or bleaches, make sure they are suitable for washing machine use.
- Descaler could contain components that can damage part of your washing machine.
- Remove the spots with a stainless steel cleaning agent.
- Never use steel wool.

■ The water circulation nozzle

- Clean the water circulation nozzle, if clogged.

■ Cleaning your washer

1. Exterior

Proper care of your washer can extend its life.

The outside of the machine can be cleaned with warm water and a neutral, non-abrasive household detergent.

Immediately wipe off any spills. Wipe with a damp cloth.

Try not to damage the surface with sharp objects.

* **IMPORTANT:** Do not use methylated spirit, solvents or similar products.

2. Interior

Dry around the washer door opening, flexible gasket and door glass. These areas should always be clean to ensure a water-tight seal.

Run washer through a complete cycle using hot water.

Repeat process if necessary.

NOTE: Remove hard water deposits using only cleaners labeled as safe for washing machines.

■ Winterizing instructions

If the washer is stored in an area where freezing can occur or moved in freezing temperatures, follow these winterizing instructions to prevent damage to the washer:

1. Turn off water supply tap.
2. Disconnect hoses from water supply and drain water from hoses.
3. Plug electrical cord into a properly grounded electrical outlet.
4. Add 1 gallon (3.8 ℓ) nontoxic recreational vehicle (RV) antifreeze to empty wash drum. Close door.
5. Set spin cycle and let washer spin for 1 minute to drain out all the water.
Not all of the RV antifreeze will be expelled.
6. Unplug electrical power cord, dry drum interior, and close door.
7. Remove the two-compartment container from the Dispenser. Drain any water in compartments and dry the compartments.
8. Store washer in an upright position.
9. To remove antifreeze from washer after storage, run empty washer through a complete cycle using detergent.
Do not add laundry.











TROUBLESHOOTING GUIDE

* This washing machine is equipped with automatic safety functions which detect and diagnose problems at an early stage and react appropriately. When the machine does not function properly or does not function at all, check the following points before you call the Service Department.

Problem	Possible Cause	Solution
Rattling and clanking noise	<ul style="list-style-type: none"> Foreign objects such as coins or safety pins may be in drum or pump. 	<p>Stop washer and check drum and drain filter.</p> <p>If noise continues after washer is restarted, call for service.</p>
Thumping sound	<ul style="list-style-type: none"> Heavy wash loads may produce a thumping sound. This is normal. 	<p>If sound continues, washer is probably out of balance. Stop and redistribute wash load.</p>
Vibrating noise	<ul style="list-style-type: none"> Have all the transit bolts and packing been removed? Wash load may be unevenly distributed in the drum. Are all the feet resting firmly on the ground? 	<p>See Installation Instructions for removing shipping bolts.</p> <p>Stop washer and rearrange wash load.</p> <p>Adjust the leveling feet.</p> <p>Make sure all four feet are in firm contact with the floor, while the washer is in the spin cycle with load.</p>
Water leaks	<ul style="list-style-type: none"> Fill hose connection is loose at tap or washer. House drain pipes are clogged. 	<p>Check and tighten hose connections.</p> <p>Unclog drain pipe. Contact plumber if necessary.</p>
Excessive suds	<ul style="list-style-type: none"> Too much detergent or unsuitable detergent. 	<p>Reduce detergent amount or use low sudsing detergent.</p>
Water does not enter washer or it enters slowly	<ul style="list-style-type: none"> Water supply is not adequate in area. Water supply tap is not completely open. Water inlet hose is bent. The filter of the inlet hose clogged. 	<p>Check another tap in the house.</p> <p>Fully open tap.</p> <p>Straighten hose.</p> <p>Check the filter of the inlet hose.</p>
Water in the washer does not drain or drains slowly	<ul style="list-style-type: none"> Drain hose is bent or clogged. The drain filter is clogged. 	<p>Clean and straighten the drain hose.</p> <p>Clean the drain filter.</p>

Problem	Possible Cause	Solution
<p>Washer does not start</p>	<ul style="list-style-type: none"> • Electrical power cord may not be plugged in or connection may be loose. • House fuse is blown, circuit breaker tripped, or a power outage has occurred. • Water supply tap is not turned on. 	<p>Make sure plug fits tightly in wall outlet.</p> <p>Reset circuit breaker or replace fuse. Do not increase fuse capacity. If problem is a circuit overload, have it corrected by a qualified electrician.</p> <p>Turn on water supply tap.</p>
<p>Washer won't spin</p>	<ul style="list-style-type: none"> • Check that the door is firmly shut. 	<p>Close the door and press the Start/Pause button. After pressing the Start/Pause button, it may take a few moments before the clothes washer begins to spin. The door must lock before spin can be achieved.</p>
<p>Wash cycle time delayed</p>	<ul style="list-style-type: none"> • The washing time may vary by the amount of laundry, water pressure, water temperature, and other using conditions. 	<p>If the imbalance is detected or if the suds removing program operates, the wash time shall be increased.</p>

TROUBLESHOOTING GUIDE

Problem	Possible Cause	Solution
	<ul style="list-style-type: none"> • Water supply is not adequate in area. • Water supply taps are not completely open. • Water inlet hose is bent. • The filter of the inlet hose clogged. 	<p>Check another tap in the house.</p> <p>Fully open tap.</p> <p>Straighten hose.</p> <p>Check the filter of the inlet hose.</p>
	<ul style="list-style-type: none"> • Drain hose is bent or clogged. • The drain filter is clogged. 	<p>Clean and straighten the drain hose.</p> <p>Clean the drain filter.</p>
	<ul style="list-style-type: none"> • Load is too small. • Load is out of balance. • The appliance has an imbalance detection and correction system. If individual heavy articles are loaded (bath mat, bath robe, etc.) this system may stop spinning or even the spin cycle altogether if the imbalance is too great even after several spin starts. 	<p>Add 1 or 2 similar items to help balance the load.</p> <p>Rearrange load to allow proper spinning.</p>
	<ul style="list-style-type: none"> • Is the door opened or not completely closed? 	<p>Close the door completely.</p> <p>* If dE is not released, call for service.</p>
		<p>Unplug the power plug and call for service.</p>
	<ul style="list-style-type: none"> • The water overfills due to the faulty water valve. 	<p>Close the water tap.</p> <p>Unplug the power plug.</p> <p>Call for service.</p>
	<ul style="list-style-type: none"> • The water level sensor malfunction. 	
	<ul style="list-style-type: none"> • Overload in motor. 	
	<ul style="list-style-type: none"> • Overload in motor. 	
	<ul style="list-style-type: none"> • The washer experienced a power failure. 	<p>Restart the cycle.</p>

LG ELECTRONICS, INC.
LG Washing Machine Limited Warranty - USA



Your LG Washing Machine will be repaired or replaced, at LG's option, if it proves to be defective in material or workmanship under normal use, during the warranty period ("Warranty Period") set forth below, effective from the date ("Date of Purchase") of original consumer purchase of the product. This warranty is good only to the original purchaser of the product and effective only when used in the United States, including Alaska, Hawaii, and U.S. Territories.

<p><u>WARRANTY PERIOD:</u></p> <p>LABOR: One Year from the Date of Purchase.</p> <p>PARTS (except as listed below): One Year from the Date of Purchase.</p> <p>Electronic Control Board: 2 Years from the Date of Purchase.</p> <p>Drum Motor: 7 Years from the Date of Purchase.</p> <p>Stainless Steel Drum: Lifetime</p> <p>Replacement Units and Repair Parts may be new or factory remanufactured.</p> <p>Replacement Units and Repair Parts are warranted for the remaining portion of the original unit's warranty period.</p>	<p><u>HOW SERVICE IS HANDLED:</u></p> <p>In-Home Service: Please retain dealer's dated bill of sale or delivery ticket as evidence of the Date of Purchase for proof of warranty, and submit a copy of the bill of sale to the service person at the time warranty service is provided.</p> <p>Please call 1-877-714-7486 and choose the appropriate option to locate your nearest LG Authorized Service Center.</p> <p>Or visit our website at: http://www.lgservice.com</p>
---	---

THIS WARRANTY IS IN LIEU OF ANY OTHER WARRANTY, EXPRESS OR IMPLIED, INCLUDING WITHOUT LIMITATION, ANY WARRANTY OF MERCHANTABILITY OR FITNESS FOR A PARTICULAR PURPOSE. TO THE EXTENT ANY IMPLIED WARRANTY IS REQUIRED BY LAW, IT IS LIMITED IN DURATION TO THE EXPRESS WARRANTY PERIOD ABOVE. NEITHER THE MANUFACTURER NOR ITS U.S. DISTRIBUTOR SHALL BE LIABLE FOR ANY INCIDENTAL, CONSEQUENTIAL, INDIRECT, SPECIAL, OR PUNITIVE DAMAGES OF ANY NATURE, INCLUDING WITHOUT LIMITATION, LOST REVENUES OR PROFITS, OR ANY OTHER DAMAGE WHETHER BASED IN CONTRACT, TORT, OR OTHERWISE. Some states do not allow the exclusion or limitation of incidental or consequential damages or limitations on how long an implied warranty lasts, so the above exclusion or limitation may not apply to you. This warranty gives you specific legal rights and you may also have other rights that vary from state to state.

THIS LIMITED WARRANTY DOES NOT APPLY TO:

- Service trips to your home to deliver, pick up, and/or install the product, instruct, or replace house fuses or correct wiring, or correction of unauthorized repairs.
- Damages or operating problems that result from misuse, abuse, operation outside environmental specifications or contrary to the requirements of precautions in the Operating Guide, accident, vermin, fire, flood, improper installation, acts of God, unauthorized modification or alteration, incorrect electrical current or voltage, or commercial use, or use for other than intended purpose.

The cost of repair or replacement under these excluded circumstances shall be borne by the consumer.

CUSTOMER INTERACTIVE CENTER NUMBERS

<p>To obtain Customer Assistance, Product Information, or Dealer or Authorized Service Center location:</p>	<p>Call 1-877-714-7486 (24 hours a day, 365 days per year) and select the appropriate option from the menu. Or visit our website at: http://www.lgservice.com</p>
--	---

TO CONTACT LG ELECTRONICS BY MAIL:

LG Customer Interactive Center
P. O. Box 240007
201 James Record Road
Huntsville, Alabama 35824
ATTN: CIC