



Owner's Manual

Washing Machine

WM2432HW
WM2032HS
WM2032HW
WM1832CW

Please read this manual carefully. It provides instructions on safe installation, use, and maintenance. Retain it for future reference.

Record the model and serial numbers of your machine and report this information to your dealer if your machine requires service.

PRODUCT FEATURES



ⓘ **Direct Drive System**
The advanced Brushless DC motor directly drives the drum without belt and pulley.

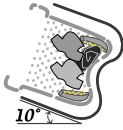

ⓘ **Tilted Drum and Extra Large Door Opening**
Tilted drum and extra large opening make it possible to load and unload clothing more easily.

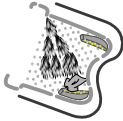

ⓘ **Water Circulation (WM2432HW, WM2032HS, WM2032HW)**
Spray detergent solution and water onto the load over and over. Clothes are soaked more quickly and thoroughly during wash cycle. The detergent suds can be removed more easily by the water shower during rinse cycle. The water circulation system uses both water and detergent more efficiently.

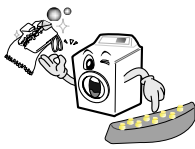

ⓘ **RollerJets (WM2432HW, WM2032HS, WM2032HW)**
Washing ball enhances the wash performance and reduces damage to the clothing. The jets spray and help tumble clothes to enhance washing performance while maintaining fabric care.



ⓘ **Built-in Heater (WM2432HW, WM2032HS, WM2032HW)**
Internal heater automatically heats the water to the best temperature on selected cycles.



ⓘ **Child Lock**
The Child lock prevents children from pressing any button to change the settings during operation.

CONTENTS

Important Safety Information	3
Specifications.....	4
Installation Instructions	5
Preparation Before Washing.....	10
Using the Dispenser	11
Cycles	13
How to Use the Washer.....	14
Maintenance	17
Troubleshooting Guide	20
Warranty	23

IMPORTANT SAFETY INFORMATION

READ ALL INSTRUCTIONS BEFORE USE

WARNING!

For your safety, the information in this manual must be followed to minimize the risk of fire or explosion, electric shock, or to prevent property damage, personal injury, or loss of life.

IMPORTANT SAFETY INSTRUCTIONS

WARNING: To reduce the risk of fire, electric shock, or injury to persons when using the washer, follow basic precautions, including the following:

- **Read all instructions before using the washer.**
- **Do not wash articles that have been previously cleaned in, washed in, soaked in, or spotted with gasoline, dry cleaning solvents, or other flammable or explosive substances, as they give off vapors that could ignite or explode.**
- **Do not add gasoline, dry cleaning solvents, or other flammable or explosive substances to the wash water. These substances give off vapors that could ignite or explode.**
- **Under certain conditions, hydrogen gas may be produced in a hot water system that has not been used for 2 weeks or more. HYDROGEN GAS IS EXPLOSIVE. If the hot water system has not been used for such a period, before using the washing machine, turn on all hot water faucets and let the water flow from each for several minutes. This will release any accumulated hydrogen gas. As the gas is flammable, do not smoke or use an open flame during this time.**
- **Do not allow children to play on or in the washer. Close supervision of children is necessary when the washer is used near children.**
- **Before the washer is removed from service or discarded, remove the door to prevent children from hiding inside.**
- **Do not install or store the washer where it will be exposed to the weather.**
- **Do not tamper with controls.**
- **Do not repair or replace any part of the washer or attempt any servicing unless specifically recommended in the user-maintenance instructions or published user-repair instructions that you understand and have the skills to carry out.**
- **See Installation Instructions for grounding requirements.**
- **ALWAYS follow the fabric care instructions supplied by the garment manufacturer.**
- **Do not place items exposed to cooking oil in your washer. Items contaminated with cooking oils may contribute to a chemical reaction that could cause a load to catch fire.**
- **Do not use fabric softeners or products to eliminate static unless recommended by the manufacturer of the fabric softener or product.**

SAVE THESE INSTRUCTIONS

GROUNDING INSTRUCTIONS

This appliance must be grounded. In the event of malfunction or breakdown, grounding will reduce the risk of electric shock by providing a path of least resistance for electric current. This appliance is equipped with a cord having an equipment-grounding conductor and grounding plug. The plug must be plugged into an appropriate outlet that is properly installed and grounded in accordance with all local codes and ordinance.

- **Do not use an adapter or extension cord.**
- **Do not remove ground prong.**
- **If you don't have the proper outlet, consult an electrician.**

WARNING: Improper connection of the equipment-grounding conductor can result in risk of electric shock.

Check with a qualified electrician or serviceman if you are in doubt as to whether the appliance is properly grounded. Do not modify the plug provided with the appliance - if it does not fit the outlet, have a proper outlet installed by a qualified electrician.

SPECIFICATIONS

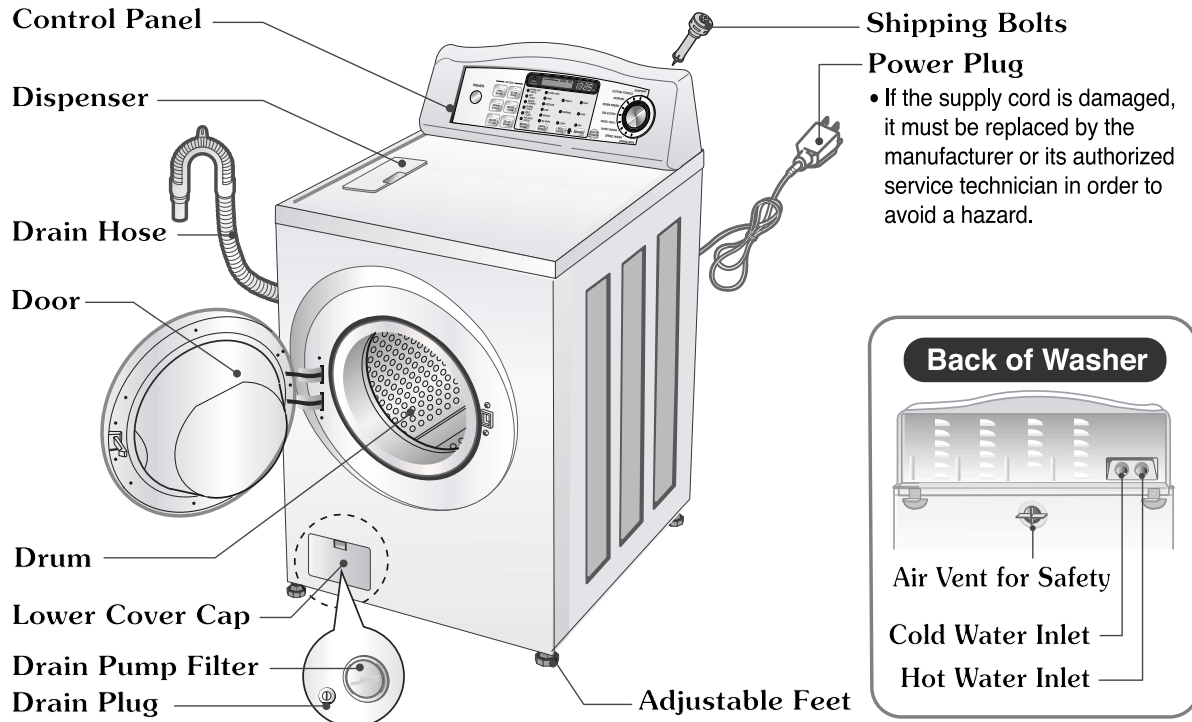

- i Ⓔ Name : Front-loading Washing Machine
- i Ⓔ Power supply : 120V~ 60Hz
- i Ⓔ Size : 68.6cm(W) X 75.0cm(D) X 108.6cm(H), 126.5cm(D, door open)
27"(W) X 29-1/2"(D) X 42-3/4"(H), 49-4/5"(D, door open)
- i Ⓔ Weight : 190 lbs. (86 kg)
- i Ⓔ Wash capacity : 3.22 cu. ft. (IEC: 3.72 cu. ft.)¹⁾
- i Ⓔ Spin speed : No Spin/400/600/800/1000/1200 rpm (WM2432HW)
No Spin/400/600/800/1000 rpm (WM2032HS, WM2032HW)
No Spin/400/600/800/900 rpm (WM1832CW)
- i Ⓔ Permissible water pressure: 4.5 ~ 145 PSI (30 ~ 1000 kPa)

f R Specifications subject to change by manufacturer.

i Ⓔ Accessories

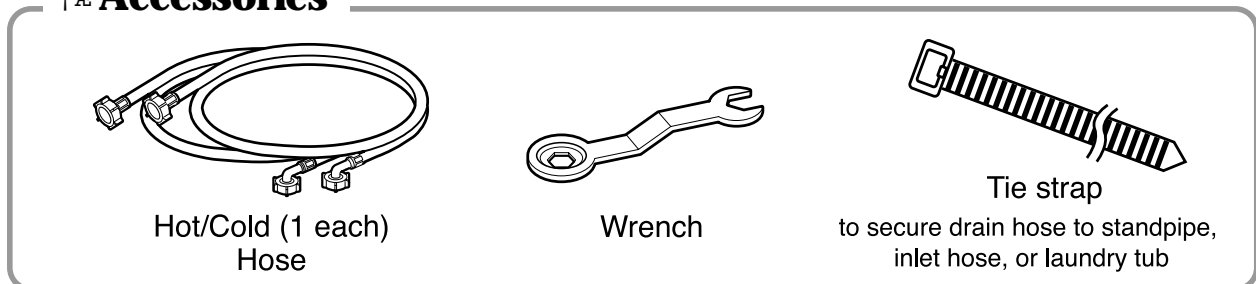

1) Per IEC 60456, washes the equivalent of a 3.72 cu. ft. agitator washer.

INSTALLATION INSTRUCTIONS

Install or store unit where it will not be exposed to temperatures below freezing or exposed to outside weather conditions.

Properly ground washer to conform with all governing codes and ordinances.

The base opening must not be obstructed by carpeting when the washing machine is installed on a carpeted floor.

In countries where there are areas which may be subject to infestation by cockroaches or other vermin, pay particular attention to keeping the appliance and its surroundings in clean condition at all times.

Any damage which may be caused by cockroaches or other vermin will not be covered by the appliance guarantee.

⚠ Shipping bolts

The appliance is fitted with shipping bolts to prevent internal damage during transport.

⚠ Removing shipping bolts

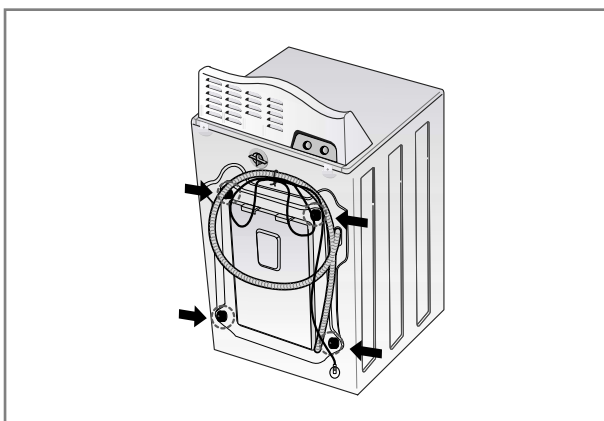

1. To prevent internal damage during transport, the special 4 bolts are locked. Before operating the washer, remove the bolts and braces.

- If they are not removed, it may cause heavy vibration, noise, and malfunction.

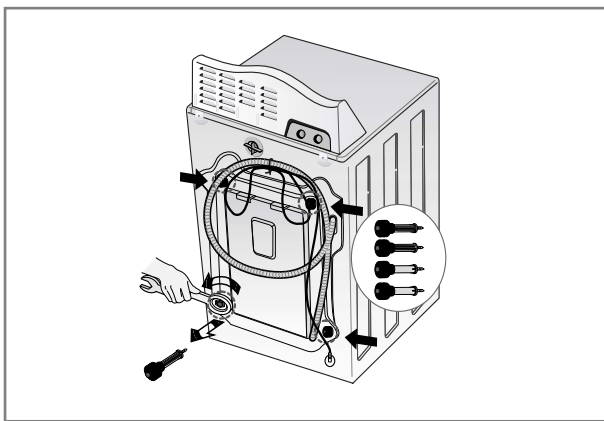

2. Unscrew the 4 bolts with the wrench supplied.

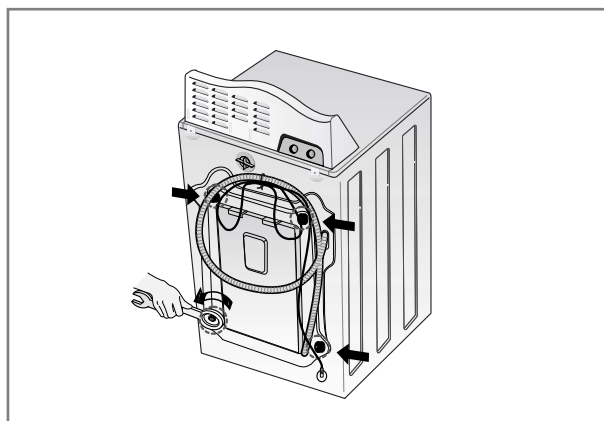

3. Take out the 4 bolts and braces by twisting the braces slightly. Keep the 4 bolts, braces and the wrench for future use.

- Whenever the appliance is transported, the shipping bolts and braces must be replaced.

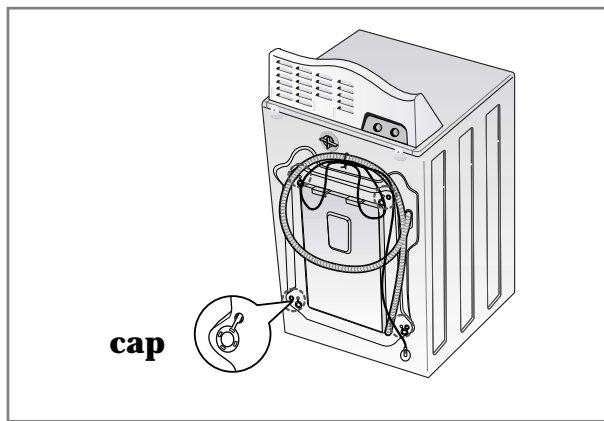

4. Close the holes with the caps supplied.

INSTALLATION INSTRUCTIONS

⚠️ Installation clearances

The location must be large enough to fully open the washer door.

⚠️ Washer dimensions

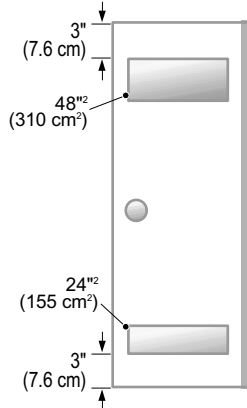
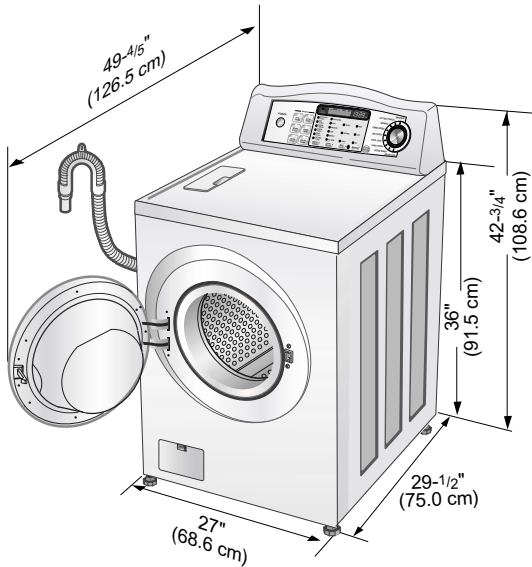

[Closet door with vents]

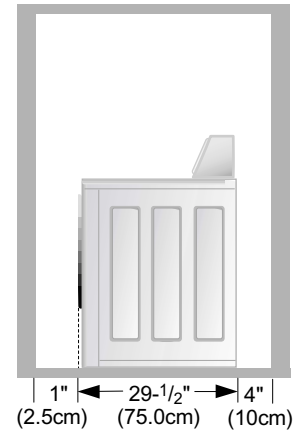

[Side view]

- Most installations require a minimum 4 in. (10 cm) clearance behind the washer.

⚠️ Minimum installation spacing for recessed area or closet installation

The following dimensions shown are for the minimum spacing allowed.

Additional spacing should be considered for installation and servicing.

- Additional clearances might be required for wall, door and floor moldings.
- Additional spacing of 1 in. (2.5 cm) on all sides of the washer is recommended to reduce noise transfer.
- For closet installation, with a door, minimum ventilation openings in the top and bottom of the door are required. Louvered doors with equivalent ventilation openings are acceptable.

Companion appliance spacing should also be considered.

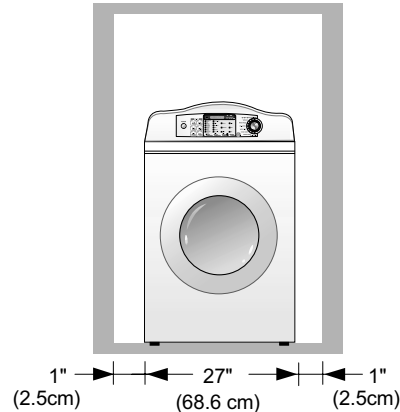

[Front view]

⚠️ Level floor

Allowable slope under entire washer is 1°.

⚠️ Power outlet

Must be within 60 in. (1.5m) of either side of the washer. Do not overload the outlet with more than one appliance.

INSTALLATION INSTRUCTIONS

ⓘ Ⓐ Electrical connection

- Do not use an extension cord or double adapter.
- If the supply cord is damaged, it must be replaced by the manufacturer or its authorized service technician in order to avoid a hazard.
- Always unplug the machine and turn off the water supply after use.
- Connect the machine to a grounded socket in accordance with current wiring regulations.
- The appliance must be positioned so that the plug is easily accessible.

ⓘ Ⓐ Connecting water supply hose

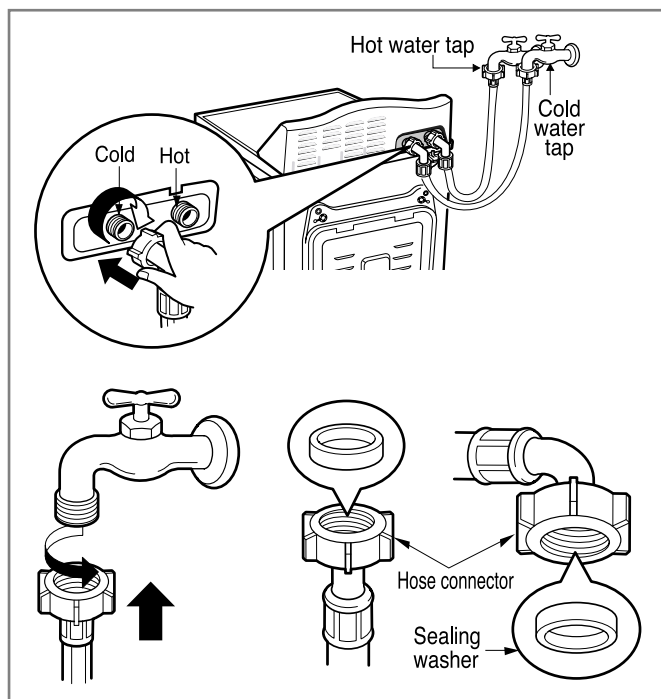

- Water supply pressure must be between 4.5 ~ 145 PSI (30~1000 kPa)
- Don't strip or crossthread when connecting Inlet hose to the valve.
- If the water supply pressure is more than 1000 kPa, a pressure reducer device should be installed.
- Two Sealing washers are supplied with the water inlet hoses to prevent water leaks.
- Check water tightness of washing machine connections by turning the tap completely on.
- Periodically check the condition of the hose and replace the hose if necessary.
- Make sure that there is no bent in the hose and that it is not crushed.
- The Inlet hose which has red connector is for the hot water tap.
- Hot and cold water faucets **MUST** be installed properly to your washer's water inlet.

NOTE : Washing Machine is to be connected to the water mains using new hoses.
Old hoses should not be used.

Repairs to the washing machine must only be carried out qualified personnel. Repairs carried out by inexperienced persons may cause injury or serious malfunctioning. Contact your local service center.

Do not install your washing machine in rooms where temperatures below freezing may occur.
Frozen hoses may burst under pressure. The reliability of the electronic control unit may be impaired at temperatures below the freezing point.

If the appliance is delivered in the winter months and temperatures are below freezing.
Store the washing machine at room temperature for a few hours before putting it into operation.

INSTALLATION INSTRUCTIONS

Installation of drain hose

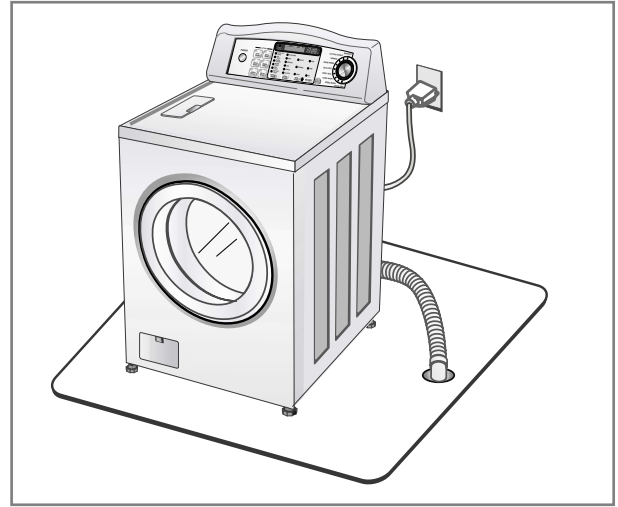
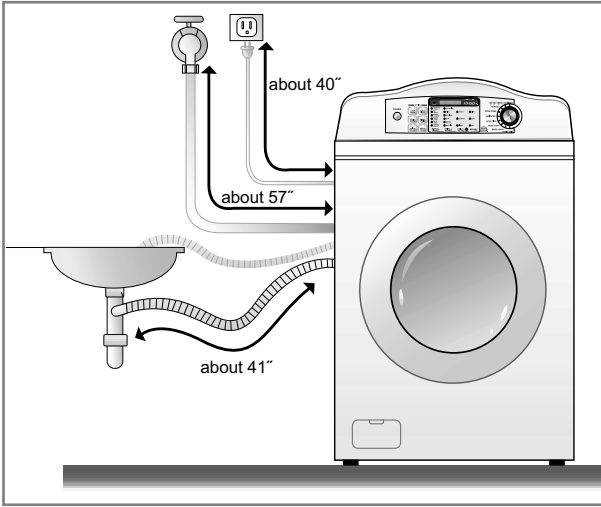

- This washer has a siphon break.
- Place the end of the drain hose in the hole of the floor drain system.

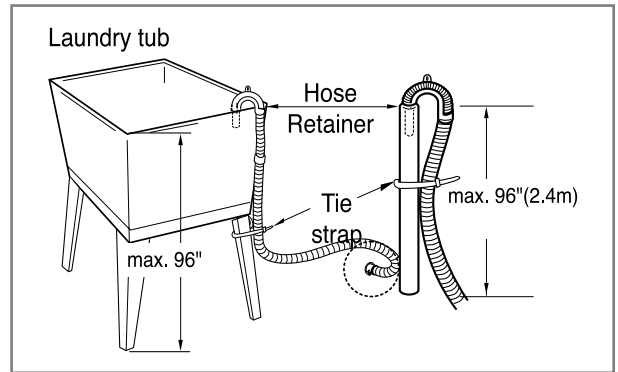
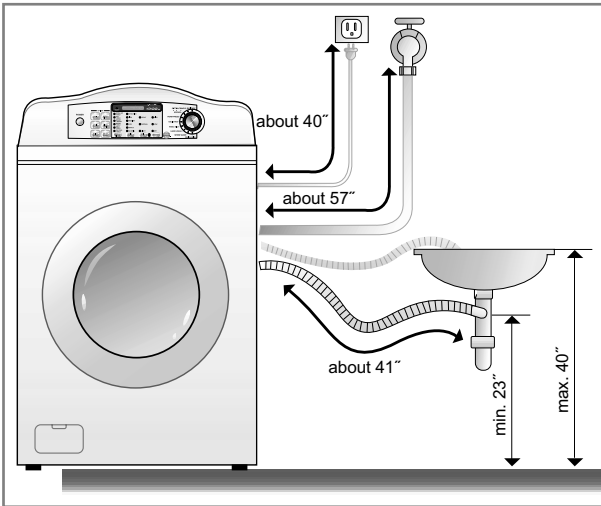

- The drain hose should not be placed higher than 96 in. from the bottom of the washer.
- Properly securing the drain hose will protect the floor from damage due to water leakage.

- When installing the drain hose at a sink, secure it so it cannot break away and cause flooding and damage.
- Properly securing the drain hose will protect the floor from damage due to water leakage.

This equipment is not designed for maritime use or for mobile installations such as in RV's, aircraft, etc. Turn off the valve if the machine is to be left for any length of time (e.g. holiday), especially if there is no floor drain (gully) in the immediate vicinity.

When disposing of the appliance, cut off the power cable, and destroy the plug.

Disable the door lock to prevent young children being trapped inside.

Packaging material (e.g. Films, Styrofoam) can be dangerous for children. There is a risk of suffocation! Keep all packaging from children.

INSTALLATION INSTRUCTIONS

i Level adjustment



- Leveling the washing machine properly prevents excessive noise and vibration. Install the appliance on a solid and level floor surface, preferably in a corner of the room.

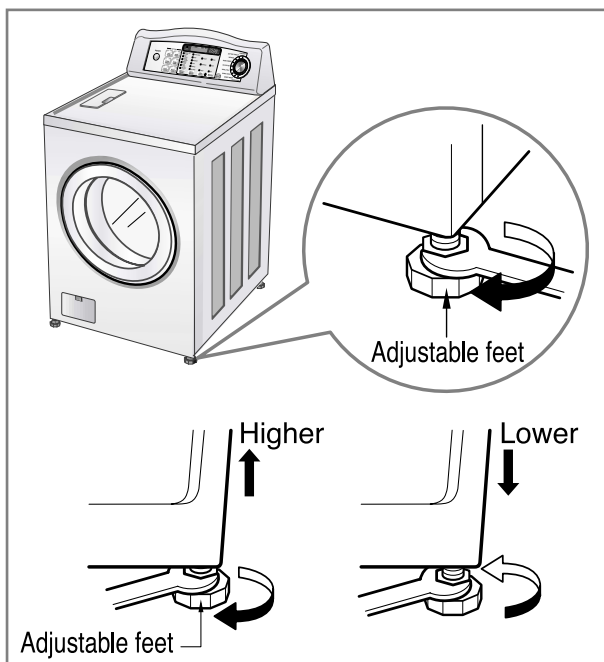

- If the floor is uneven, adjust the adjustable feet as required. (Do not insert pieces of wood, etc. under the feet.)
- Make sure that all four feet are stable and resting on the floor and then check that the appliance is perfectly level. (Use a leveling tool.)



f Diagonal Check

When pushing down the edges of the washing machine top plate diagonally, the machine should not move up and down at all. (Please, check both directions.)

If machine rocks when pushing the machine top plate diagonally, adjust the feet again.

PREPARATION BEFORE WASHING

WARNING

To reduce the risk of fire, electric shock, or injury to persons, read the **IMPORTANT SAFETY INSTRUCTIONS** before operating this appliance.

1. Fabric Care Labels

Look for a care label on your clothes. This will tell you about the fabric content of your garment and how it should be washed.

2. Sorting

To get the best results, sort clothes into loads that can be washed with the same wash cycle.

Different fabrics need to be washed in different ways.

Always sort dark colors from pale colors and whites. Wash separately as dye and lint transfer can occur causing discoloration of white clothing. If possible, do not wash heavily soiled items with lightly soiled ones.

Soil (Heavy, Normal, Light)	Separate clothes according to amount of soil.
Color (White, Lights, Darks)	Separate white fabrics from colored fabrics.
Lint (Lint Producers, Collectors)	Wash lint producers and lint collectors separately.

3. Check before loading

Combine large and small items in a load. Load large items first.

Large items should not be more than half the total wash load.

Do not wash single items. This may cause an out-of-balance load. Add one or two similar items.

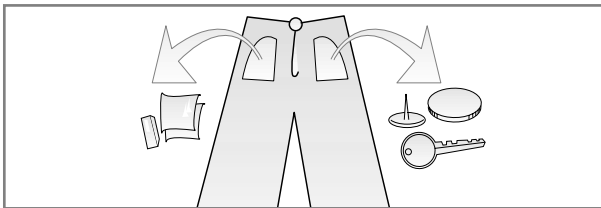

- Check all the pockets to make sure that they are empty. Things such as clip, matches, pens, coins, and keys can damage both your washer and your clothes.

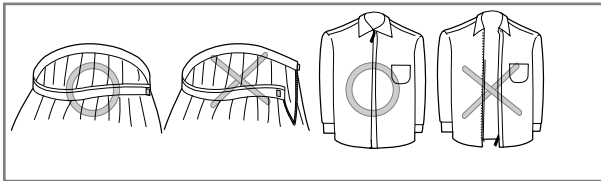

- Close zippers, hooks, and strings to make sure that these items do not snag on other clothes.

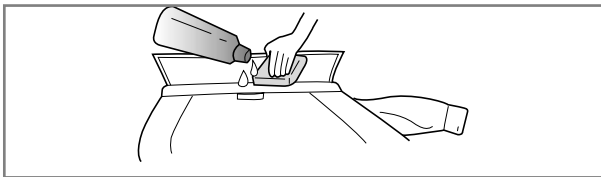

- Pretreat dirt and stains by brushing a little detergent dissolved in water onto stains like collars and cuffs to help lift dirt.

USING THE DISPENSER

The automatic dispenser consists of four compartments which hold 1) liquid chlorine bleach, 2) liquid fabric softener, 3) liquid or powdered detergent for prewash and 4) liquid or powdered detergent and color safe bleach for main wash.

All laundry products can be added at once in their respective dispenser compartments.

They will be dispensed at the appropriate time for most effective cleaning. After loading the laundry additives into the dispenser, close the dispenser lid.

Add detergent, bleach and fabric softener to the automatic dispenser following these steps:

1. Open the dispenser lid.
2. Load the laundry products into the appropriate compartments.
3. Close the dispenser lid.

ⓘ About detergent

Low lathering detergent is recommended for this washer. Use the manufacturer's recommended amount.

If low lathering detergent is not available, a reduced amount of regular detergent may be used.

Because reducing the amount of detergent may reduce cleaning, it is important to pretreat stains, sort carefully by color and soil level, and avoid overloading.

Detergent usage may need to be adjusted for water temperature, water hardness, size and soil level of the load. For best results, avoid using too much detergent.

NOTE : Liquid detergent will drain into the washer drum as it is added.

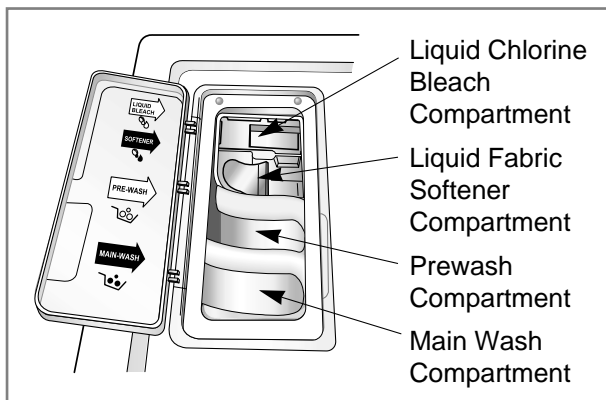

1. Prewash Detergent Compartment

- Add detergent to this compartment when using the Prewash option. Liquid or powdered detergent may be used in this compartment. The detergent will automatically be dispensed during Prewash if the Prewash option is selected.
- Add 1/2 the recommended amount of detergent to the Prewash compartment and the recommended amount of detergent to the main wash compartment.

USING THE DISPENSER

2. Main Wash Detergent Compartment

- Add measured detergent to this compartment for Main wash. Detergent is flushed from the dispenser at the beginning of the cycle. Either powdered or liquid detergent can be used.
- Liquid or powdered color-safe bleach may be added to the main wash compartment along with the same type of detergent, liquid or powdered.

NOTE : If you are using the Prewash option with Main wash, powdered detergent must be used in the main wash compartment since liquid detergent will drain into the washer drum as it is added.

3. Liquid Bleach Compartment

- Add measured liquid chlorine bleach to this compartment. The bleach will be automatically dispensed at the proper time during the wash cycle.
- Do not exceed the maximum fill line. Overfilling can cause early dispensing of the bleach which could result in damaged clothes.
- Do not pour undiluted liquid chlorine bleach directly onto the load or into the drum. Fabric damage can occur.
- Do not use powdered bleach in this compartment.

4. Fabric Softener Compartment

- Add recommended amount of fabric softener to this compartment.
- Dilute concentrated softeners with warm water to the fill line.
- Do not exceed the maximum fill line. Overfilling can cause early dispensing of the fabric softener which could result in stained clothes.
- Do not pour fabric softener directly on the wash load.
- The fabric softener will be automatically dispensed during the last rinse cycle.

CYCLES

Select cycles designed for different types of fabric and soil levels.

WM2432HW

Cycle	Fabric type	Wash/Rinse Temp.		Spin speed	Soil Level	Pre-Wash	Quick Cycle	Stain Cycle	Extra Rinse	Rinset Spin
		Extra Hot / Cold								
Sanitary	Heavily soiled underwear, work clothes, diapers, etc.	Extra Hot / Cold		Extra high	Normal					
				No spin Low Medium High	Heavy Light	○			○	○
Cotton / Towels	Cotton, linen, towels, shirts, sheets	Warm / Cold		Extra high	Normal					
		Warm / Warm Hot / Cold Tap Cold / Cold Cold / Cold		No spin Low Medium High	Heavy Light	○			○	○
Normal	Mixed loads, work clothes, jeans, shirts	Warm / Cold		High	Normal					
		Warm / Warm Hot / Cold Tap Cold / Cold Cold / Cold		Extra high No spin Low Medium	Heavy Light	○			○	○
Perm Press	Dress shirts / pants, wrinkle free clothing, poly / cotton blend clothing, table cloths	Warm / Cold		Medium	Normal					
		Warm / Warm Hot / Cold Tap Cold / Cold Cold / Cold		High No spin Gentle Low	Heavy Light	○			○	○
Delicates	Dress shirts / blouses, nylons, sheer or lacy garment	Cold / Cold		Low	Normal					
		Warm / Cold Warm / Warm Tap Cold / Cold		Medium No spin Gentle	Heavy Light	○			○	○
Wool / Silk	Woolens, silk identified as machine washable	Cold / Cold		Gentle	Normal					
		Warm / Cold Warm / Warm Tap Cold / Cold		Low Medium No spin	Light				○	○
Hand Wash	Items labeled "hand washable"	Cold / Cold		Gentle	Normal					
		Warm / Cold Warm / Warm Tap Cold / Cold		Low Medium No spin	Light				○	○
Speed Wash	Lightly soiled clothing	Hot / Cold		Extra high	Light					
		Tap Cold / Cold Cold / Cold Warm / Cold Warm / Warm		No spin Gentle Low Medium High	Normal Heavy				○	○
Drain + Spin	Drain / Spin only			High						
				Extra high No spin Gentle Low Medium						

WM2032HS / WM2032HW / WM1832CW

Cycle	Fabric type	Wash/Rinse Temp.		Spin speed	Soil Level	Pre-Wash	Quick Cycle	Stain Cycle	Extra Rinse	Rinset Spin
		Extra Hot / Cold								
Sanitary ¹⁾	Heavily soiled underwear, work clothes, diapers, etc.	Extra Hot / Cold		High	Normal					
				No spin Low Medium	Heavy Light	○			○	○
Cotton / Towels	Cotton, linen, towels, shirts, sheets	Warm / Cold		High	Normal					
		Warm / Warm Hot / Cold Cold / Cold		No spin Low Medium	Heavy Light	○			○	○
Normal	Mixed loads, work clothes, jeans, shirts	Warm / Cold		High	Normal					
		Warm / Warm Hot / Cold Cold / Cold		No spin Low Medium	Heavy Light	○			○	○
Perm Press	Dress shirts / pants, wrinkle free clothing, poly / cotton blend clothing, table cloths	Warm / Cold		Medium	Normal					
		Warm / Warm Hot / Cold Cold / Cold		High No spin Gentle Low	Heavy Light	○			○	○
Delicates	Dress shirts / blouses, nylons, sheer or lacy garment	Cold / Cold		Low	Normal					
		Warm / Cold Warm / Warm		Medium No spin Gentle	Heavy Light	○			○	○
Hand Wash	Items labeled "hand washable"	Cold / Cold		Gentle	Normal					
		Warm / Cold Warm / Warm		Low Medium No spin	Light				○	○
Speed ¹⁾ Wash	Lightly soiled clothing	Hot / Cold		High	Light					
		Cold / Cold Warm / Cold Warm / Warm		No spin Gentle Low Medium	Normal Heavy				○	○

¹⁾WM2032HS / WM2032HW only.

HOW TO USE THE WASHER

WM2432HW

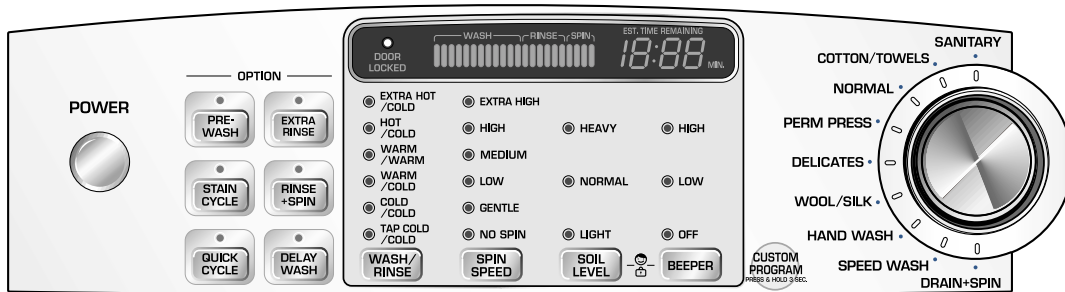

WM2032HS / WM2032HW

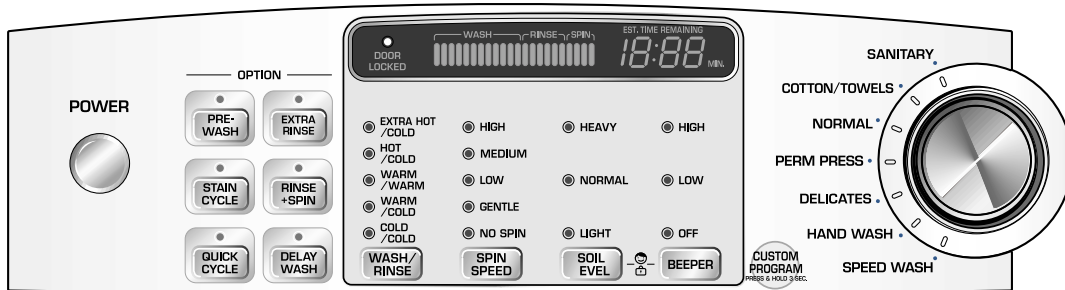

WM1832CW

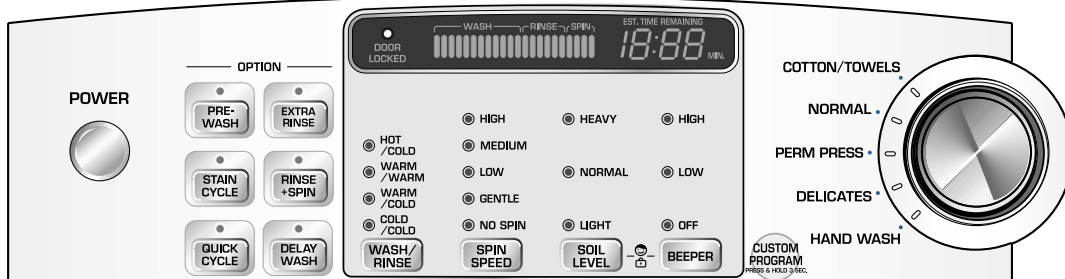

1. Cycles

- Rotate the **Cycle selector knob** to select cycle designed for different types of fabric and soil levels.
- Each cycle has a preset Water Temperature, Spin Speed, Soil Level, and Option.

See the page 13.

- The preset settings can be changed anytime before Start.

2. Custom Program

- Custom Program allows you to store a customized wash cycle for future use.

• To make a Custom Program:

1. Select a cycle.
2. Select the other desired **Wash / Rinse Temp., Spin Speed, Soil Level.**
3. Select the desired Options.
4. Press and hold Custom Program button 3 seconds (2 beep sounds).
5. Press **Start/Pause.**

The Custom program is now stored for future use. To reuse the program, select Custom Program and press **Start/Pause.**

HOW TO USE THE WASHER

3. Beeper

- Choose **High / Low / Off**.

4. Wash / Rinse Temperature

- Select a water temperature based on the type of load you are washing.
- Follow the fabric care label and chart below for best results.

Wash Water Temp.	Suggested Garment
Extra Hot 167°F (75°C)	Kitchen towels, sheets, and baby garments
Hot 122°F (50°C)	
Warm 104°F (40°C)	Whites and Heavy soiled color-fast items
Cold 77°F (25°C)	Most loads
	Brightly colored items, washable woolens

- Warm rinses leave the loads dryer than cold rinses. Warm rinses increase wrinkling.
- In cold climates, a warm rinse makes the load more comfortable to handle.
- Cold rinses save energy.
- The Cold rinse temperatures depend on the cold water at your faucet.
- Warm rinses are regulated at approximately 86°F (30°C).
- For the Tap Cold / Cold setting, both wash and rise temperatures depend on the cold water at your faucet.

5. Spin speed

- To change the spin speed, select the **Spin Speed** button until the desired setting is on.

6. Soil Level

- To change the soil level, select the **Soil Level** button until the desired setting is on.

HOW TO USE THE WASHER

OPTION

1. Prewash

- Use this option for loads that need pretreatment. Adds 16 minutes prewash and drain.
- **When using Prewash option, do not use liquid detergent in the Main Wash Compartment. Use powdered for the main wash.**

2. Stain cycle

- Adds time to the wash and rinse for better stain removal.
- Automatically provides a rinse.

3. Quick Cycle

- The Quick cycle offers a quick cycle time.
- Suggested uses include freshening newly purchased clothes, or clothing that has been packed away.

4. Extra Rinse

- This option provides an additional rinse.
- Use this option to ensure the removal of detergent or bleach residue from garments.

5. Rinse+Spin

- Use this option to rinse and then spin.

6. Delay Wash

- Allows the start of any cycle to be delayed for 1~19(12, 9) hours.
- Choose the wash cycle for your load, and then press the Delay Wash button once for one hour or press the button again to increase the delay wash time up to 19(12, 9) hours in one hour increments.

CHILD LOCK



- Use this option to prevent unwanted use of the washer. Press and hold Soil Level and Beeper button for 3 seconds to lock/unlock control.
- When Child lock is set, " [L] " blinks and all buttons are disabled but Power button. You can thereby lock the washer while it is operating.

DOOR LOCKED

- Lights whenever the door of the washer is locked.
- The door can be unlocked by pressing the **Start/Pause** button to stop the washer.

STATUS INDICATOR

- These lights show elapsed time of the cycle the washer is operating.

EST. TIME REMAINING

- This display shows:
 - a) the estimated time remaining in the cycle when operating,
 - b) the error code when an error has been detected.

START/PAUSE

- Use this button to **start/stop** the washer.

POWER

- Use this button to turn the Power **On/Off**.

MAINTENANCE

Before cleaning the washer interior, unplug the electrical power cord to avoid electrical shock hazards. When disposing of the appliance, cut off the power cable, destroy the plug, and disable the door lock to prevent young children from being trapped inside.

ⓘ The water inlet filter

- "iE" error message will blink on the control panel when water does not enter the dispenser.
- If your water is very hard or contains traces of lime deposit, the water inlet filter may become clogged. We recommend cleaning it every few months.

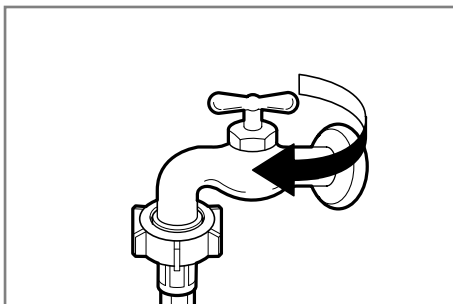

1. Turn off the water tap.

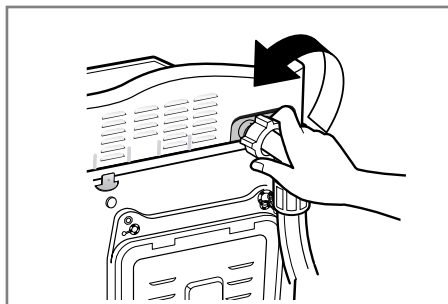

2. Unscrew the water inlet hose.

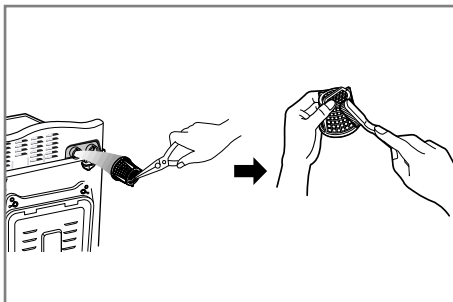

3. Clean the filter using a hard bristle brush.

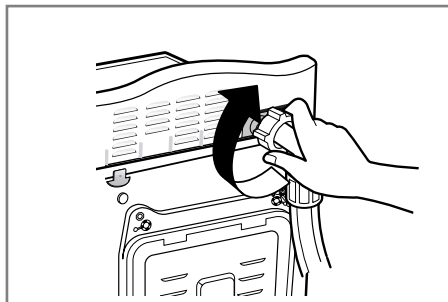

4. Tighten up the inlet hose.

ⓘ The drain pump filter

- The drain filter collects threads and small objects left in the laundry. Check regularly that the filter is clean to ensure smooth running of your machine.

⚠ CAUTION

First drain using the drain hose and then open the pump filter to remove objects. Be careful when draining if the water is hot.

- Allow the water to cool down before cleaning the drain pump filter.

1. Open the lower cover cap (①). Turn the drain plug (②) to pull out the hose.

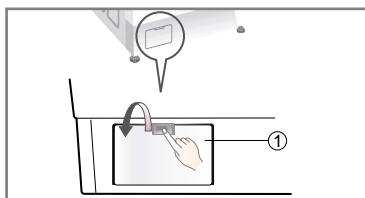

2. Unplug the drain plug (②), allowing the water to flow out. At this time use a vessel to prevent water from flowing onto the floor. When water does not flow any more, turn the pump filter (③) open to the left.

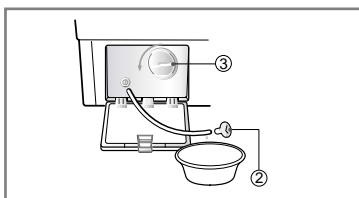

3. Remove out any foreign objects from the pump filter (③). After cleaning, turn the pump filter (③) clockwise and insert the drain plug (②) to the original place. Close the lower cover cap (①).

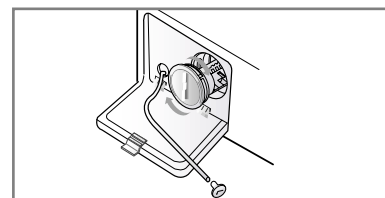

MAINTENANCE

ⓘ Ⓐ Cleaning the Dispenser

- The dispenser may need to be cleaned periodically due to laundry additive build-up.

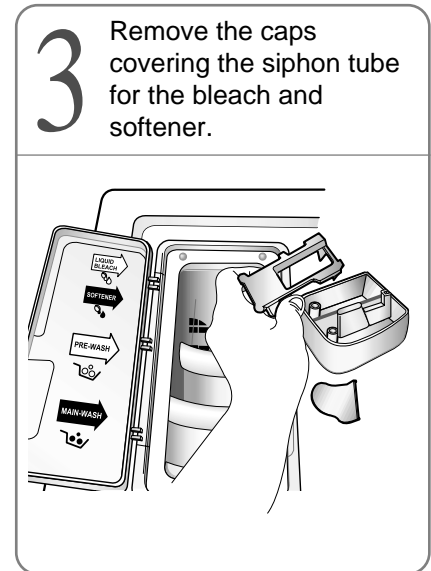
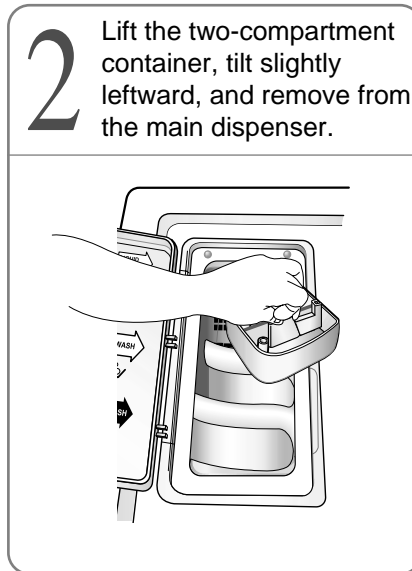
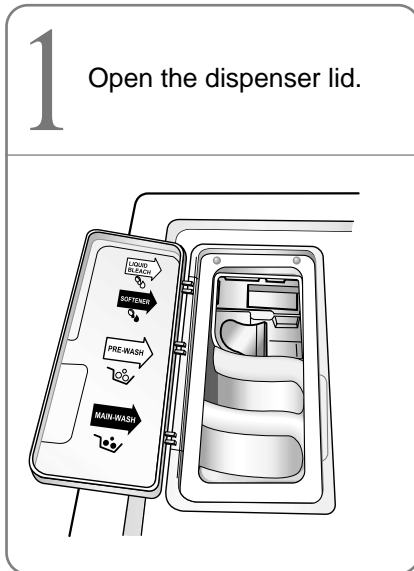

- Once the two-compartment container is removed from the main dispenser, take it to a sink. Run warm water and a soft brush or cloth over the two parts to remove any excess laundry additives.
- Clean the main dispenser area using water and a soft cloth. Once the main dispenser is clean, follow the illustrations in reverse order to replace the two compartment container to its original location.

NOTE : Do not use any cleaning substance on the main dispenser but water. It is possible for cleaning substances to drain into the tub. If this should happen, set the washer for a rinse and spin cycle to remove any cleaning substance from the washer before doing a load of laundry.

ⓘ Ⓐ The washing drum

- If you live in a hard water area, limescale can continuously build up in places where it cannot be seen and it is not easily removed from the drum. Over time the build-up of scale clogs appliances, and if it is not kept in check, these will eventually have to be replaced.
- Although the washing drum is made of Stainless steel, specks of rust can be caused by small metal articles (paper clips, safety pins, etc.) which have been left in the drum.
- The washing drum should be cleaned from time to time.
- If you use descaling agents, dyes, or bleaches, make sure they are suitable for washing machine use.
- Descaler could contain components that can damage part of your washing machine.
- Remove the spots with a stainless steel cleaning agent.
- Never use steel wool.

ⓘ ⓘ Cleaning your washer

1. Exterior

Proper care of your washer can extend its life.

The outside of the machine can be cleaned with warm water and a neutral, non-abrasive household detergent.

Immediately wipe off any spills. Wipe with a damp cloth.

Try not to damage the surface with sharp objects.

*f***R**IMPORTANT: Do not use methylated spirit, solvents or similar products.

2. Interior

Dry around the washer door opening, flexible gasket and door glass. These areas should always be clean to ensure a water-tight seal.

Run washer through a complete cycle using hot water.

Repeat process if necessary.

NOTE : Remove hard water deposits using only cleaners labeled as safe for washing machines.

ⓘ ⓘ Winterizing instructions

If the washer is stored in an area where freezing can occur or moved in freezing temperatures, follow these winterizing instructions to prevent damage to the washer:

1. Turn off water supply tap.
2. Disconnect hoses from water supply and drain water from hoses.
3. Plug electrical cord into a properly grounded electrical outlet.
4. Add 1 gallon (3.8 ℓ) nontoxic recreational vehicle (RV) antifreeze to empty wash drum. Close door.
5. Set spin cycle and let washer spin for 1 minute to drain out all the water.
Not all of the RV antifreeze will be expelled.
6. Unplug electrical power cord, dry drum interior, and close door.
7. Remove the two-compartment container from the Dispenser. Drain any water in compartments and dry the compartments.
8. Store washer in an upright position.
9. To remove antifreeze from washer after storage, run empty washer through a complete cycle using detergent.
Do not add laundry.











TROUBLESHOOTING GUIDE

f^R This washing machine is equipped with automatic safety functions which detect and diagnose problems at an early stage and react appropriately. When the machine does not function properly or does not function at all, check the following points before you call the Service Department.

Problem	Possible Cause	Solution
Rattling and clanking noise	<ul style="list-style-type: none"> Foreign objects such as coins or safety pins may be in drum or pump. 	<p>Stop washer and check drum and drain filter.</p> <p>If noise continues after washer is restarted, call for service.</p>
Thumping sound	<ul style="list-style-type: none"> Heavy wash loads may produce a thumping sound. This is normal. 	<p>If sound continues, washer is probably out of balance. Stop and redistribute wash load.</p>
Vibrating noise	<ul style="list-style-type: none"> Have all the transit bolts and packing been removed? Wash load may be unevenly distributed in the drum. Are all the feet resting firmly on the ground? 	<p>See Installation Instructions for removing shipping bolts.</p> <p>Stop washer and rearrange wash load.</p> <p>Adjust the leveling feet.</p>
Water leaks	<ul style="list-style-type: none"> Fill hose connection is loose at tap or washer. House drain pipes are clogged. 	<p>Check and tighten hose connections.</p> <p>Unclog drain pipe. Contact plumber if necessary.</p>
Excessive lathering	<ul style="list-style-type: none"> Too much detergent or unsuitable detergent. 	<p>Reduce detergent amounts or use low sudsing detergent.</p>
Water does not enter washer or it enters slowly	<ul style="list-style-type: none"> Water supply is not adequate in area. Water supply tap is not completely open. Water inlet hose is bent. The filter of the inlet hose clogged. 	<p>Check another tap in the house.</p> <p>Fully open tap.</p> <p>Straighten hose.</p> <p>Check the filter of the inlet hose.</p>
Water in the washer does not drain or drains slowly	<ul style="list-style-type: none"> Drain hose is bent or clogged. The drain filter is clogged. 	<p>Clean and straighten the drain hose.</p> <p>Clean the drain filter.</p>

Problem	Possible Cause	Solution
<p>Washer does not start</p>	<ul style="list-style-type: none"> • Electrical power cord may not be plugged in or connection may be loose. • House fuse is blown, circuit breaker tripped, or a power outage has occurred. • Water supply tap is not turned on. 	<p>Make sure plug fits tightly in wall outlet.</p> <p>Reset circuit breaker or replace fuse. Do not increase fuse capacity. If problem is a circuit overload, have it corrected by a qualified electrician.</p> <p>Turn on water supply tap.</p>
<p>Washer won't spin</p>	<ul style="list-style-type: none"> • Check that the door is firmly shut. 	<p>Close the door and press the Start/Pause button. After pressing the Start/Pause button, it may take a few moments before the clothes washer begins to spin. The door must lock before spin can be achieved.</p>
<p>Wash cycle time delayed</p>	<ul style="list-style-type: none"> • The washing time may vary by the amount of laundry, water pressure, water temperature, and other using conditions. 	<p>If the imbalance is detected or if the suds removing program operates, the wash time shall be increased.</p>

TROUBLESHOOTING GUIDE

Problem	Possible Cause	Solution
	<ul style="list-style-type: none"> • Water supply is not adequate in area. • Water supply taps are not completely open. • Water inlet hose is bent. • The filter of the inlet hose clogged. 	<p>Check another tap in the house.</p> <p>Fully open tap.</p> <p>Straighten hose.</p> <p>Check the filter of the inlet hose.</p>
	<ul style="list-style-type: none"> • Drain hose is bent or clogged. • The drain filter is clogged. 	<p>Clean and straighten the drain hose.</p> <p>Clean the drain filter.</p>
	<ul style="list-style-type: none"> • Load is too small. • Load is out of balance. • The appliance has an imbalance detection and correction system. If individual heavy articles are loaded (bath mat, bath robe, etc.) this system may stop spinning or even the spin cycle altogether if the imbalance is too great even after several spin starts. 	<p>Add 1 or 2 similar items to help balance the load.</p> <p>Rearrange load to allow proper spinning.</p>
	<ul style="list-style-type: none"> • Is the door opened or not completely closed? 	<p>Close the door completely.</p> <p><i>fR</i>If <i>dE</i> is not released, call for service.</p>
		Unplug the power plug and call for service.
	<ul style="list-style-type: none"> • The water overfills due to the faulty water valve. 	<p>Close the water tap.</p> <p>Unplug the power plug.</p> <p>Call for service.</p>
	<ul style="list-style-type: none"> • The water level sensor malfunction. 	
	<ul style="list-style-type: none"> • Overload in motor. 	
	<ul style="list-style-type: none"> • Overload in motor. 	
	<ul style="list-style-type: none"> • The washer experienced a power failure. 	Restart the cycle.

LG WASHING MACHINE LIMITED WARRANTY-USA

LG Electronics Inc. will repair or at its option replace, without charge, your product if it proves to be defective in material or workmanship under normal use during the warranty period set forth below, effective from the date of original consumer purchase of the product. This limited warranty is good only to the original purchaser of the product and effective only when used in the United States including Alaska, Hawaii, and U.S. Territories.

<p><u>WARRANTY PERIOD:</u></p> <p>Labor: 1 Year from the Date of Purchase.</p> <p>All Parts: 1 Year from the Date of Purchase.</p> <p>Drum Tub, Motor: 5 Years from the Date of Purchase.</p>	<p><u>HOW SERVICE IS HANDLED:</u></p> <p>Call 1-877-714-7486 and choose the appropriate prompt. Please have product type (Washing Machine), model number, serial number, and ZIP code ready.</p> <p>The warranted 1-year of labor covers the cost of In-Home Service on all parts including the Drum Tub and Motor.</p>
---	--

THIS WARRANTY IS IN LIEU OF ANY OTHER WARRANTIES, EXPRESS OR IMPLIED, INCLUDING WITHOUT LIMITATION, ANY WARRANTY OF MERCHANTABILITY OR FITNESS FOR A PARTICULAR PURPOSE. TO THE EXTENT ANY IMPLIED WARRANTY IS REQUIRED BY LAW, IT IS LIMITED IN DURATION TO THE EXPRESS WARRANTY PERIOD ABOVE. LG WILL NOT BE LIABLE FOR ANY CONSEQUENTIAL, INDIRECT, OR INCIDENTAL DAMAGES OF ANY KIND, INCLUDING LOST REVENUES OR PROFITS, IN CONNECTION WITH THE PRODUCT. SOME STATES DO NOT ALLOW LIMITATION ON HOW LONG AN IMPLIED WARRANTY LASTS OR THE EXCLUSION OF INCIDENTAL OR CONSEQUENTIAL DAMAGES, SO THE ABOVE LIMITATIONS OR EXCLUSIONS MAY NOT APPLY TO YOU.

THIS LIMITED WARRANTY DOES NOT APPLY TO:

1. Service trips to your home to deliver, pick up, and/or install the product, instruct, or replace house fuses or correct wiring, or correction of unauthorized repairs; and
2. Damages or operating problems that result from misuse, abuse, operation outside environmental specifications or contrary to the requirements or precautions in the Operating Guide, accident, vermin, fire, flood, improper installation, acts of God, unauthorized modification or alteration, incorrect electrical current or voltage, or commercial use, or use for other than intended purpose.
3. Therefore, the cost of repair or replacement of such a defective product shall be borne by the consumer.

CUSTOMER INTER-ACTIVE CENTER NUMBERS:

<p>To Prove Warranty Coverage</p>	<p>Retain your Sales Receipt to prove date of purchase. A copy of your Sales Receipt must be submitted at the time warranty service is provided.</p>
<p>To Obtain Nearest Authorized Service Center or Sales Dealer, or to Obtain Product, Customer, or Service Assistance</p>	<p>Call 1-877-714-7486 (Monday ~ Friday, 7 AM ~ 8 PM CT; and Saturday, 8 AM ~ 5 PM CT) and choose the appropriate prompt from the menu, and have your product type (Washing Machine), model number, serial number, and ZIP Code; or visit our website at http://www.lgservice.com.</p>