



Service

This manual is to be used by qualified appliance technicians only. Maytag does not assume any responsibility for property damage or personal injury for improper service procedures done by an unqualified person.



Top Load Washer

This Base Manual covers general information.

Refer to individual Technical Sheet for information on specific models.

This manual includes, but is not limited to the following:

- | | | | |
|-------------------|-------------------|-------------------|-------------------|
| AAV4000AW* | CW6500* | MAV3757AW* | MAV5920EW* |
| AAV7000AG* | CW9505* | MAV3758AW* | MAVT236AW* |
| AAV7000AJ* | HAV1200AR* | MAV3855AG* | MAVT346AW* |
| AAV7000AK* | HAV1200AW* | MAV3855AK* | MAVT446AW* |
| AAV7000AW* | HAV4200AK* | MAV3855AW* | MAVT546EW* |
| AAV8000AG* | HAV4200AT* | MAV385SAW* | NAV2335AJ* |
| AAV8000AJ* | HAV4200AW* | MAV3905AW* | NAV2335AW* |
| AAV8005EW* | MAV1655AW* | MAV3955EW* | NAV3335AW* |
| AAV9000AG* | MAV1755AW* | MAV408DAW* | NAV5805AW* |
| CAV1004AW* | MAV208DAW* | MAV4755AW* | NAV8805EW* |
| CAV2004AJ* | MAV2755AJ* | MAV4757AW* | PAV2755AA* |
| CAV2004AK* | MAV2755AW* | MAV4758AW* | PAV3855AA* |
| CAV2005AW* | MAV2757AW* | MAV551EEW* | PAVT910AW* |
| CAV4004AG* | MAV275SAW* | MAV5758EW* | PAVT915AW* |
| CAV4004AW* | MAV308DAW* | MAV5920AG* | PAVT920AW* |
| CW5500* | | | |



Important Information

Important Notices for Servicers and Consumers

Maytag will not be responsible for personal injury or property damage from improper service procedures. Pride and workmanship go into every product to provide our customers with quality products. It is possible, however, that during its lifetime a product may require service. Products should be serviced only by a qualified service technician who is familiar with the safety procedures required in the repair and who is equipped with the proper tools, parts, testing instruments and the appropriate service information. **IT IS THE TECHNICIANS RESPONSIBILITY TO REVIEW ALL APPROPRIATE SERVICE INFORMATION BEFORE BEGINNING REPAIRS.**



WARNING

To avoid risk of severe personal injury or death, disconnect power before working/servicing on appliance to avoid electrical shock.

To locate an authorized servicer, please consult your telephone book or the dealer from whom you purchased this product. For further assistance, please contact:

Customer Service Support Center

CAIR Center

Web Site

Telephone Number

WWW.MAYTAG.COM 1-800-688-9900
WWW.AMANA.COM 1-800-843-0304

CAIR Center in Canada 1-800-688-2002
Amana Canada Product 1-866-587-2002

Recognize Safety Symbols, Words, and Labels



DANGER

DANGER—Immediate hazards which **WILL** result in severe personal injury or death.



WARNING

WARNING—Hazards or unsafe practices which **COULD** result in severe personal injury or death.



CAUTION

CAUTION—Hazards or unsafe practices which **COULD** result in minor personal injury, product or property damage.

Important Information	2
Important Safety Information	4
General Information	
Model Identification	7
Serial Label Location	7
Model Nomenclature	8
Troubleshooting	
Troubleshooting General Symptoms	9
Troubleshooting (Electronic Controls)	10
Troubleshooting (Mechanical Controls)	14
Component Specifications	
Component Testing Information (Electronic)	15
Component Testing Information (Mechanical)	16
Service Specifications	17
Disassembly Procedures	
Console Disassembly	18
Drain Pump/Belt Removal	19
Top Cover Removal	20
Hinge/Lid Removal	20
Lid Switch Removal	20
Water Valve Removal	21
Dispenser Removal	21
Front Panel Removal	21
Motor Removal	22
Flume/Thermistor Removal	22
Tub Top Removal	23
Agitator/Spinner/Outer Tub/Transmission Removal	23
Tub Seal/Transmission Disassembly	25
Drive Pulley and Cam Removal	26
Brake Disassembly	26
Tub Seal Replacement	27
Spin Bearing Replacement	27
Oil Seal Replacement	27
Snubber/Brake Assembly	27
Installing Thrust Bearing	28
Base Replacement	28
Transmission Operation	29
Determine Brake Rotor Condition	29
Brake Adjustment	29
Check Brake Disengagement	30
To Adjust Brake Disengagement	30
Appendix A	
Installation Instructions	A-1
Appendix B	
Use & Care Information	B-1

Important Safety Information



WARNING

To reduce the risk of fire, electric shock, serious injury or death to persons when using your washer, follow these basic precautions:

- Read all instructions before using the washer.
- Refer to the Grounding Instructions in the Installation Manual for the proper grounding of the washer.
- Do not wash articles that have been previously cleaned in, washed in, soaked in, or spotted with gasoline, dry-cleaning solvents, or other flammable or explosive substances as they give off vapors that could ignite or explode.
- Do not add gasoline, dry-cleaning solvents, or other flammable or explosive substances to the wash water. These substances give off vapors that could ignite or explode.
- Under certain conditions, hydrogen gas may be produced in a hot water system that has not been used for two weeks or more. Hydrogen gas is explosive. If the hot water system has not been used for such a period, before using a washing machine or combination washer-dryer, turn on all hot water faucets and let the water flow from each for several minutes. This will release any accumulated hydrogen gas. The gas is flammable, do not smoke or use an open flame during this time.
- Do not allow children to play on or in the washer. Close supervision of children is necessary when the washer is used near children. This is a safety rule for all appliances.
- Before the washer is removed from service or discarded, remove the lid to the washing compartment.
- Do not reach into the washer if the wash tub is moving.
- Do not install or store the washer where it will be exposed to water and/or weather.
- Do not tamper with the controls.
- Do not repair or replace any part of the washer, or attempt any servicing unless specifically recommended in the User-Maintenance instructions or in published user-repair instructions that you understand and have the skills to carry out.
- To reduce the risk of an electric shock or fire, do not use an extension cord or an adapter to connect the washer to the electrical power source.
- Use your washer only for its intended purpose, washing clothes.
- Always disconnect the washer from electrical supply before attempting any service. Disconnect the power cord by grasping the plug, not the cord.
- Install the washer according to the Installation Instructions. All connections for water, drain, electrical power and grounding must comply with local codes and be made by licensed personnel when required. Do not do it yourself unless you know how!
- To reduce the risk of fire, clothes which have traces of any flammable substances such as vegetable oil, cooking oil, machine oil, flammable chemicals, thinner, etc. or anything containing wax or chemicals such as in mops and cleaning cloths, must not be put into the washer. These flammable substances may cause the fabric to catch on fire by itself.
- Do not use fabric softeners or products to eliminate static unless recommended by the manufacturer of the fabric softener or product.
- Keep your washer in good condition. Bumping or dropping the washer can damage safety features. If this occurs, have your washer checked by a qualified service person.
- Replace worn power cords and/or loose plugs.
- Be sure water connections have a shut-off valve and that fill hose connections are tight. Close the shut-off valves at the end of each wash day.
- Loading lid must be closed any time the washer is in operational fill, tumble, or spin. Do not attempt to bypass the loading lid switch by permitting the washer to operate with the loading lid open.
- Always read and follow manufacturer's instructions on packages of laundry and cleaning aids. Heed all warnings or precautions. To reduce the risk of poisoning or chemical burns, keep them out of the reach of children at all times (preferably in a locked cabinet).
- Always follow the fabric care instructions supplied by the garment manufacturer.
- Never operate the washer with any guards and/or panels removed.
- Do not operate the washer with missing or broken parts.
- Do not bypass any safety devices.
- Failure to install, maintain, and/or operate this washer according to the manufacturer's instructions may result in conditions which can produce bodily injury and/or property damage.

NOTE: The Warnings and Important Safety Instructions appearing in this manual are not meant to cover all possible conditions and situations that may occur. Common sense, caution and care must be exercised when installing, maintaining, or operating the washer.

Always contact your dealer, distributor, service agent or the manufacturer about any problems or conditions you do not understand.

Important Safety Information

WARNING

To avoid personal injury or death from improper servicing, make sure you read and understand the descriptions and meaning of various safety symbols, words and labels used in this manual, before attempting any procedures described in the manual. Failure to understand and comply with safety information may result in severe personal injury or death.

General Information

This Service Manual describes the operation, disassembly, troubleshooting, and repair of the washer. It is intended for use by authorized technicians who troubleshoot and repair these units.

NOTE: It is assumed that users of this manual are familiar with the use of tools and equipment used to troubleshoot and repair electrical, and mechanical systems; and understand the terminology used to describe and discuss them.

Related Publications

This is a base service manual, covering a range of similar models. It is intended to be used in conjunction with the Parts Manual and Technical Sheet covering the specific model being serviced.

Electrical Service Information

Proper Grounding and Polarization of 120 Volts Wall Outlets

For the safety of our customers and the Service Technician, ALL appliances have a three-prong power cord and MUST be connected to a properly polarized AND grounded wall outlet.

This information was written for those who do not understand grounding and polarization of a wall outlet. A 120 volt wall outlet must always be wired as shown below.

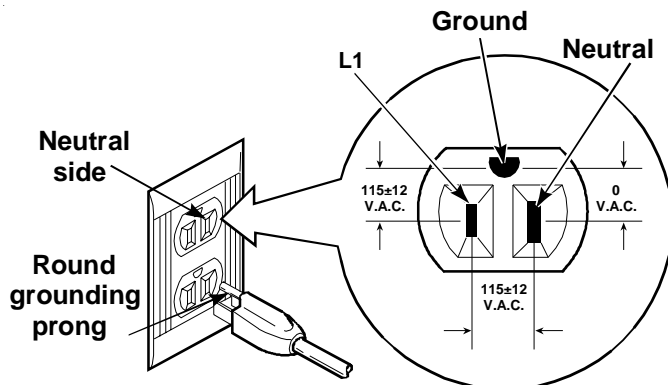

About Ground Wires

In the event of an electrical short circuit, a ground wire reduces the risk of electric shock by providing an escape wire for the electric current.

Standard accepted color coding for ground wires is **green** or **green with a yellow stripe**.

Grounding wires and wires colored like grounding wires are **NOT** to be used as current carrying conductors.

WARNING

To reduce the risk of fire, electric shock, serious injury or death, all wiring and grounding must conform with the latest edition of the National Electric Code, ANSI/NFPA 70, or the Canadian Electrical Code, CSA C22.1, and such local regulations as might apply. It is the customer's responsibility to have the wiring and fuses checked by a qualified electrician to make sure your home has adequate electrical power to operate the washer.

WARNING

To avoid risk of personal injury or death due to electrical shock:

- **Observe all local codes and ordinances.**
- Disconnect electrical power to unit before servicing.
- Ground appliance properly.
- Check with a qualified electrician if you are not sure this appliance is properly grounded.
- DO NOT ground to gas line.
- DO NOT ground to cold water pipe if pipe is interrupted by plastic, nonmetallic gaskets, or other insulating (nonconducting) materials.
- DO NOT modify plug on power cord. If plug does not fit electrical outlet, have proper outlet installed by qualified electrician.
- DO NOT have a fuse in the neutral or ground circuit. A fuse in the neutral or ground circuit could result in an electrical shock.
- DO NOT use an extension cord with this appliance.
- DO NOT use an adapter plug with this appliance.
- DO NOT pinch power cord.

Important Safety Information

Explanation

Polarization—This means that the larger slot must be neutral and the small slot must be at line voltage.

Mispolarized—The outlet is incorrectly wired so that the larger slot is at line voltage and the smaller slot is neutral.

Grounded—This means the round hole connection is connected to earth ground through a connection to the main power panel.

Ungrounded—The round hole connection is not complete to earth ground and/or the main power panel.

Grounding Instructions

WARNING

- To avoid the risk of electrical shock or death, do not alter the plug.
- Do not remove grounding prong when installing grounded appliance in a home that does not have three wire grounding receptacle. Under no condition is grounding prong to be cut off or removed. It is the personal responsibility of the consumer to contact a qualified electrician and have properly grounded three prong wall receptacle installed in accordance with appropriate electrical codes.
- To avoid the risk of electrical shock or death, this equipment must be grounded.

This equipment **MUST** be grounded. In the event of an electrical short circuit, grounding reduces the risk of electric shock by providing an escape wire for the electric current. This unit is equipped with a cord having a grounding wire with a grounding plug. The plug must be plugged into an outlet that is properly installed and grounded.

Consult a qualified electrician or technician if grounding instructions are not completely understood, or if doubt exists as to whether the equipment is properly grounded. Do not use an extension cord. If the product power cord is too short, have a qualified electrician install a three-slot receptacle. This unit should be plugged into a separate 60 hertz circuit with the electrical rating as shown in the appropriate drawing. Models operate with a supply voltage of 120 Volts.



General Information

Model Identification

Complete registration card and promptly return. If registration card is missing:

- For Maytag product call 1-800-688-9900 or visit the Web Site at www.maytag.com
- For product in Canada call 1-866-587-2002 or visit the Web Site at www.maytag.com.

When contacting provide product information located on rating label. Record the following:

Model Number: _____
Manufacturing Number: _____
Serial or S/N Number: _____
Date of purchase: _____
Dealer's name and address: _____



Serial Label is located on the back of the unit and on top of the Console.



Service

Keep a copy of sales receipt for future reference or in case warranty service is required. To locate an authorized technician:

- For Maytag call 1-800-462-9824 or visit the Web Site at www.maytag.com.
- For product in Canada call 1-866-587-2002 or visit the Web Site at www.maytag.com.

Warranty service must be performed by an authorized technician. We also recommend contacting an authorized technician, if service is required after warranty expires.

Parts and Accessories

Purchase replacement parts and accessories over the phone. To order accessories for your product call:

- For Maytag product call 1-800-462-9824 or visit the Web Site at www.maytag.com.
- For product in Canada call 1-866-587-2002 or visit the Web Site at www.maytag.com.

Extended Service Plan

We offer long-term service protection for this new washer.

- Dependability Plus™ Extended Service Plan is specially designed to supplement Maytag's strong warranty. This plan covers parts, labor, and travel charges.
Call 1-800-925-2020 for information.

General Information

Washer Nomenclature

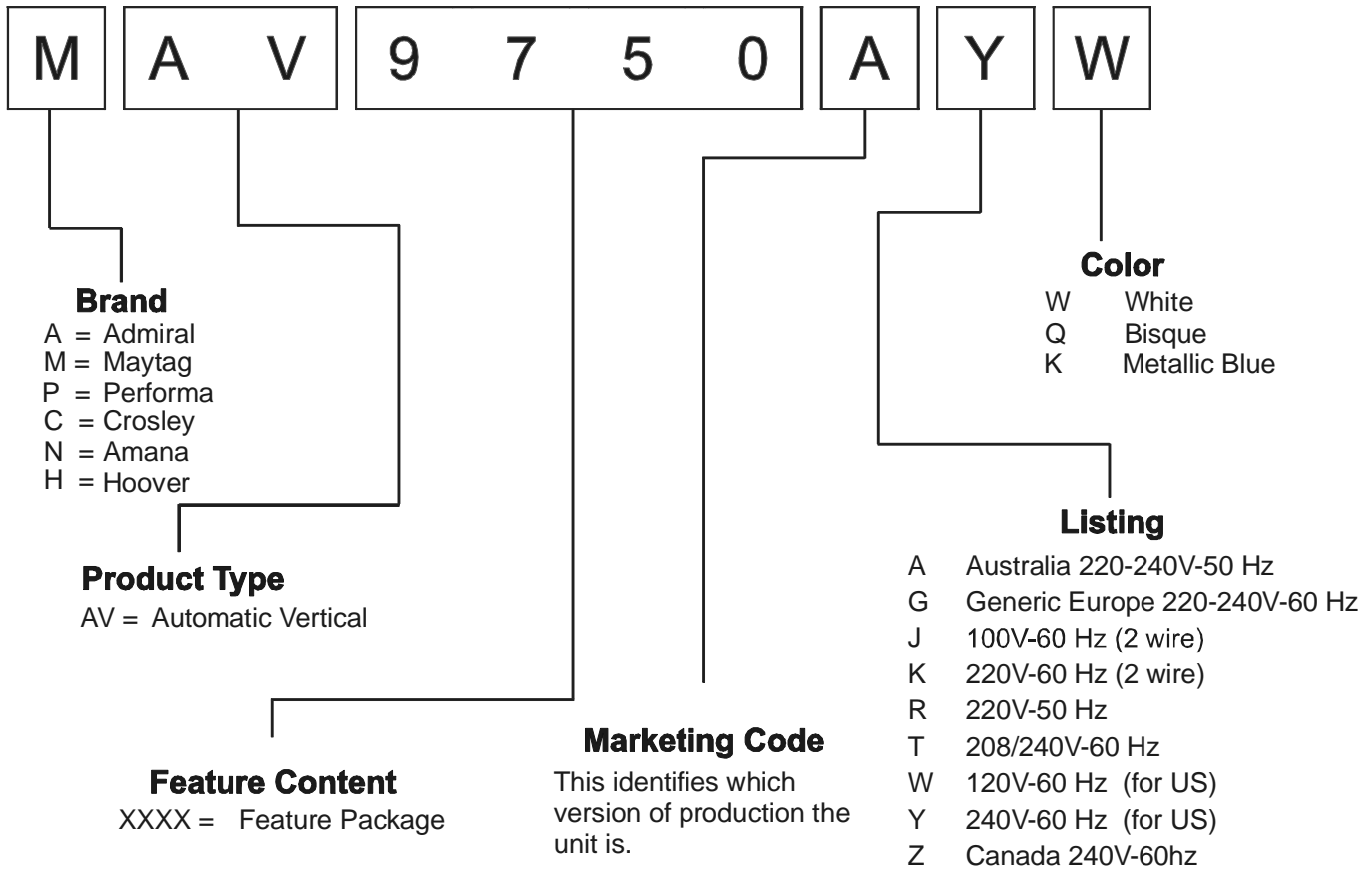

Troubleshooting and Diagnostic Guide is located inside the Console.

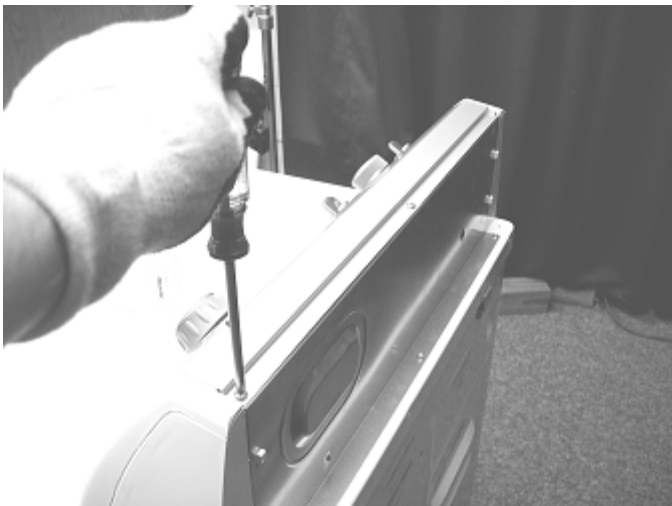

Troubleshooting Procedures

Due to possibility of personal injury or property damage, always contact an authorized technician for servicing or repair of this unit.



CAUTION

All safety information must be followed as provided in the Service Manual.



WARNING

To avoid risk of electrical shock, personal injury or death, disconnect power to unit before servicing.

Noisy and/or Vibration/Walking

- Check for proper installation and leveling of unit.
- Legs properly adjusted and locked with no damage.
- Stabilizer rear legs secure and locking properly (not jamming).
- Pads on feet of leveling legs.
- Solid and secure flooring.
- Check condition of belt.
- Check transmission pulley for correct Thrust Bearing adjustment.
- Check transmission for spin bearing noise.
- Check center tub seal.
- Check agitator for correct installation.
- Check the suspension springs are properly installed and lubricated.
- Check for loose screws on the cabinet.
- Check base is flat against floor.
- Check for binding Tub Seal.
- Check brake is disengaging properly.
- Check between tubs for something contacting spinner.
- Check for proper adjustment of the Thrust Bearing.
- Check for broken impeller on Drain Pump.
- Perform Torque Test.
- When washer passes all checks place a one pound unbalance weight in washer and check for 600 RPM. If washer fails check brake and cam adjustments. Replace Transmission if brake and cam adjustments are ok.

Over Fill

- Check water pressure to washer is 20 PSI minimum.
- Disconnect power cord. Replace Water Valve if it continues to flow.
- Check Pressure Switch for proper operation.
- Check Pressure Switch air hose for leaks damage or obstruction.

Finger Faucet

- Faucet will not operate with washer set to Hot/Cold.

Wrong Water Temperature

- Run the Service Cycle to verify water temperatures.
- Check that both faucets are turned on fully.
- Make sure water heater is set to deliver a minimum of 120°F (49°C) hot water at the tap. Also check water heater capacity and recovery rate.
- If the water heater is located a long distance from washer, the water line may need to be purged prior to starting wash cycle.
- Check for reversed inlet hoses at the faucet or water valve.
- Check wiring at the Water Valve, Timer, and ATC.

Will Not Spin/Spin Speed Too Slow

- Check power supply to washer is between 108V to 132V with a load on the circuit.
- Check slow spin speed is not selected.
- Refer to Service Cycle and check spin speeds.
- Check condition of drive belt.
- Check drain system in the home is functioning properly.
- Check for blocked or kinked drain hose.

Will Not Run or Start

- Plug cord into live electrical outlet. Check for proper voltage.
- Check fuse or reset circuit breaker.
- Check water supply is working.
- Check water valve connections are good.
- Check the line filter and water valve filter.
- Check if Lid Switch is functional. Lid must be closed before washer will operate.
- Check Control Board is operating properly.
- Check drive motor is operating properly.
- Check for a blown thermal fuse.
- Check for obstructions in Drain Pump.
- Turn transmission pulley by hand. If locked in agitation direction, replace transmission.
- Power supply to washer is between 108V and 132V during a load on circuit.

No Water Fill

- Check to make sure water supply is turned on fully.
- Check electrical circuit and connections at the Water Valve, and Pressure Switch.
- Check for kinks in inlet hoses.
- Check for clogged inlet screens.
- Check Water Valves separately for fill.
- Check for low water pressure. May be dependent on pressure entering home. Variations may occur due to usage in the home at the time machine is used.
- Check for frozen pipes and hoses.
- Check resistance of Water Valve coils.
- Check for loose connections at the Pressure Switch or on the Machine Control Board

Will Not Drain

- Check for restricted drain system.
- In cold climates check for frozen drain hose.
- Check tub to pump hose for twist in hose.

Troubleshooting Procedures

Due to possibility of personal injury or property damage, always contact an authorized technician for servicing or repair of this unit.

CAUTION

All safety information must be followed as provided in the Service Manual.

WARNING

To avoid risk of electrical shock, personal injury or death, disconnect power to unit before servicing.

ENTER SERVICE MODE

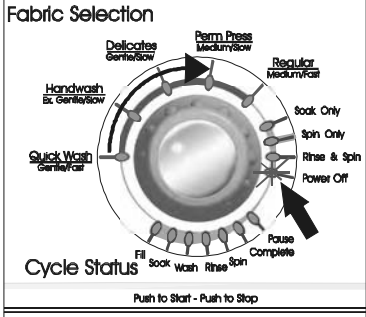
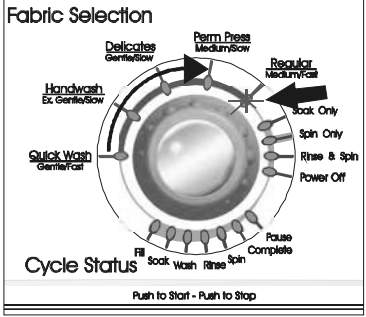
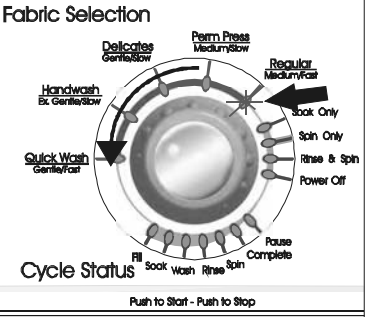
 <p>Fabric Selection</p> <p>Cycle Status</p> <p>Push to Start - Push to Stop</p>	<p>Rotate the Cycle Selector Knob to the "Power Off" position and press knob.</p> <p>(All LED's will be off).</p>
 <p>Fabric Selection</p> <p>Cycle Status</p> <p>Push to Start - Push to Stop</p>	<p>Rotate the Cycle Selector Knob clockwise past "Power Off" twice and stop at "Regular".</p> <p>(LED's will illuminate as the knob is rotated).</p>
 <p>Fabric Selection</p> <p>Cycle Status</p> <p>Push to Start - Push to Stop</p>	<p>Rotate the Cycle Selector Knob counterclockwise one revolution back to "Regular" and press knob.</p> <ul style="list-style-type: none"> • Power Off, Rinse & Spin LED will blink (if error codes are present). Regular LED will be illuminated. • Model I.D. is displayed by the LED's around the bottom of the dial. • Model I.D. can be redisplayed while in Service Mode by setting knob to "Handwash" and pressing. • Refer to chart for Model I.D.

Troubleshooting Procedures

Due to possibility of personal injury or property damage, always contact an authorized technician for servicing or repair of this unit.



CAUTION

All safety information must be followed as provided in the Service Manual.



WARNING

To avoid risk of electrical shock, personal injury or death, disconnect power to unit before servicing.

EXIT SERVICE MODE

<p>Fabric Selection</p> <p>Delicates GentleSlow Perm Press MediumSlow Regular MediumFast</p> <p>Handwash Ex. GentleSlow Soak Only Spin Only Rinse & Spin Power Off</p> <p>Quick Wash GentleFast</p> <p>Cycle Status Fill Soak Wash Rinse Spin Pause Complete</p> <p>Push to Start - Push to Stop</p>	<p>Rotate Cycle Selection Knob to "Power Off" and press knob. or Allow 5 minutes of inactivity. or Disconnect power</p>
--	---

DISPLAY/CLEAR SERVICE CODES

<p>Fabric Selection</p> <p>Delicates GentleSlow Perm Press MediumSlow Regular MediumFast</p> <p>Handwash Ex. GentleSlow Soak Only Spin Only Rinse & Spin Power Off</p> <p>Quick Wash GentleFast</p> <p>Cycle Status Fill Soak Wash Rinse Spin Pause Complete</p> <p>Push to Start - Push to Stop</p>	<p>Enter Service Mode then set Cycle Selection Knob to "Rinse & Spin". Press knob</p> <ul style="list-style-type: none"> Rinse & Spin LED will blink if codes other than power interrupt are present. Press knob to view codes. Press once for each code. Codes are displayed newest to oldest. Machine beeps three times after last service code is displayed. To clear codes display a code then press and hold Cycle Selection Knob until machine beeps twice. Rinse & Spin LED stops blinking. Refer to chart for Service Codes.
--	--

CONSOLE SWITCH TEST

<p>Fabric Selection</p> <p>Delicates GentleSlow Perm Press MediumSlow Regular MediumFast</p> <p>Handwash Ex. GentleSlow Soak Only Spin Only Rinse & Spin Power Off</p> <p>Quick Wash GentleFast</p> <p>Cycle Status Fill Soak Wash Rinse Spin Pause Complete</p> <p>Push to Start - Push to Stop</p>	<p>Enter Service Mode then set Cycle Selection Knob to "Delicate" and press knob.</p> <ul style="list-style-type: none"> Power Off LED blinks. Pause and Delicates LED's are illuminated.
	<p>Rotate the Cycle Selection Knob clockwise for ascending, and counterclockwise for descending test mode. Rotate 32 clicks in the same direction to complete the test.</p>

Troubleshooting Procedures

Due to possibility of personal injury or property damage, always contact an authorized technician for servicing or repair of this unit.

CAUTION

All safety information must be followed as provided in the Service Manual.

WARNING

To avoid risk of electrical shock, personal injury or death, disconnect power to unit before servicing.

CONSOLE SWITCH TEST CON'T

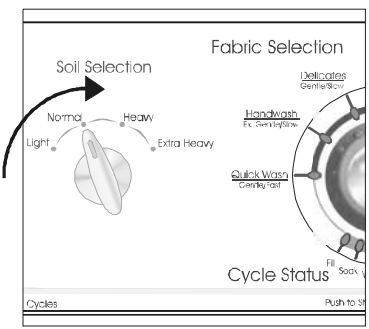
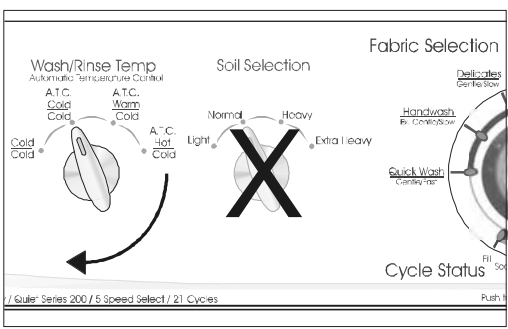
 <p>Fabric Selection: Delicates GentleSlow, Handwash Ex. GentleSlow, Quick Wash GentleFast, Fill Soak, Cycles, Push to Start</p> <p>Soil Selection: Normal, Heavy, Extra Heavy, Light</p> <p>Cycle Status: Fill Soak, Push to Start</p>	<p>Press the Cycle Selection Knob to activate the test for the rotary switches. The test begins with the rotary switch immediately to the left of the Cycle Selection Knob. Rotate the switch in either direction. The LED's illuminate around the bottom of the Cycle Selection Knob for each switch position.</p> <p>NOTE: Any attempt to move a knob or switch other than the one being tested results in a chirp sound.</p>
 <p>Wash/Rinse Temp: Automatic Temperature Control, A.T.C. Cold Cold, A.T.C. Warm Cold, A.T.C. Hot Cold, Cold Cold</p> <p>Fabric Selection: Delicates GentleSlow, Handwash Ex. GentleSlow, Quick Wash GentleFast, Fill Soak, Cycles, Push to Start</p> <p>Soil Selection: Normal, Heavy, Extra Heavy, Light</p> <p>Cycle Status: Fill Soak, Push to Start</p>	<p>Press the Cycle Selection Knob. The test continues with the switch immediately to the left of the previous switch tested. Repeat rotating the switch and monitoring the LED's around the bottom of the Cycle Selection Knob. Continue pressing the Cycle Selection Knob for each switch tested right to left until all rotary switches are tested.</p> <p>NOTE: The Water Level Switch is not included in this test.</p> <ul style="list-style-type: none"> After the last rotary switch is tested the next time the Cycle Selection Knob is pressed the test will continue with the rocker switches. Continue pressing the Cycle Selection Knob and testing switches until the last switch is tested. When all switches have been tested the "Complete" LED will illuminate.

SERVICE CYCLE

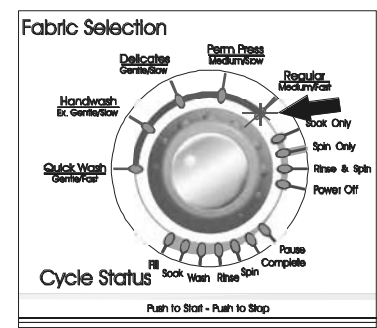
 <p>Fabric Selection: Delicates GentleSlow, Perm Press MediumFast, Regular MediumFast, Handwash Ex. GentleSlow, Quick Wash GentleFast, Fill Soak, Cycles, Push to Start</p> <p>Cycle Status: Fill Soak, Wash, Rinse, Spin, Pause, Complete, Power Off, Push to Start - Push to Stop</p>	<p>Enter Service Mode then set Cycle Selection Knob to "Regular" and press knob.</p> <ul style="list-style-type: none"> Fill and Wash LED's illuminate. Hot water fill. Press knob Fill and Rinse LED's illuminate. Cold water fill. Press knob Fill, Wash, and Rinse LED's illuminate. Selected wash temperature fill. Press knob Wash LED illuminates. Slow agitation. Press knob Wash LED blinking. Fast agitation. Press knob Spin LED illuminates. Slow spin. Press knob Spin LED blinking. Fast spin. Press Knob Complete LED illuminates. Press knob exit back to Service Mode. <p>NOTE: Fills are skipped if Pressure Switch is satisfied. Press knob until Pause LED begins blinking to pause cycle.</p>
--	---

Troubleshooting Procedures

Due to possibility of personal injury or property damage, always contact an authorized technician for servicing or repair of this unit.



CAUTION

All safety information must be followed as provided in the Service Manual.



WARNING

To avoid risk of electrical shock, personal injury or death, disconnect power to unit before servicing.

Codes displayed but not listed here should be ignored.

DIAGNOSTIC CODE CHART

Service Code Description	Service Code	Fill	Soak	Wash	Rinse	Spin	Complete	Pause
Model ID Unknown, Default model of 31 used	31	<input type="radio"/>	<input type="radio"/>	<input checked="" type="radio"/>	<input checked="" type="radio"/>	<input checked="" type="radio"/>	<input checked="" type="radio"/>	<input checked="" type="radio"/>
Rotary Switch 3 left of encoder failed at startup	28	<input type="radio"/>	<input type="radio"/>	<input checked="" type="radio"/>	<input checked="" type="radio"/>	<input checked="" type="radio"/>	<input type="radio"/>	<input type="radio"/>
Rotary Switch 2 left of encoder failed at startup	26	<input type="radio"/>	<input type="radio"/>	<input checked="" type="radio"/>	<input checked="" type="radio"/>	<input type="radio"/>	<input checked="" type="radio"/>	<input type="radio"/>
Rotary Switch 1 left of encoder failed at startup	25	<input type="radio"/>	<input type="radio"/>	<input checked="" type="radio"/>	<input checked="" type="radio"/>	<input type="radio"/>	<input type="radio"/>	<input checked="" type="radio"/>
Incorrect rotary switch position seen	24	<input type="radio"/>	<input type="radio"/>	<input checked="" type="radio"/>	<input checked="" type="radio"/>	<input type="radio"/>	<input type="radio"/>	<input type="radio"/>
Fill time less than 2 seconds	22	<input type="radio"/>	<input type="radio"/>	<input checked="" type="radio"/>	<input type="radio"/>	<input checked="" type="radio"/>	<input checked="" type="radio"/>	<input type="radio"/>
Fill time exceeded 18 minutes	21	<input type="radio"/>	<input type="radio"/>	<input checked="" type="radio"/>	<input type="radio"/>	<input checked="" type="radio"/>	<input type="radio"/>	<input checked="" type="radio"/>
Motor Thermal protector opened	19	<input type="radio"/>	<input type="radio"/>	<input checked="" type="radio"/>	<input type="radio"/>	<input type="radio"/>	<input checked="" type="radio"/>	<input checked="" type="radio"/>
Motor Thermal protector opened more than 5 times during a cycle	18	<input type="radio"/>	<input type="radio"/>	<input checked="" type="radio"/>	<input type="radio"/>	<input type="radio"/>	<input checked="" type="radio"/>	<input type="radio"/>
Thermistor Possible Short	17	<input type="radio"/>	<input type="radio"/>	<input checked="" type="radio"/>	<input type="radio"/>	<input type="radio"/>	<input type="radio"/>	<input checked="" type="radio"/>
Thermistor Possible Open	16	<input type="radio"/>	<input type="radio"/>	<input checked="" type="radio"/>	<input type="radio"/>	<input type="radio"/>	<input type="radio"/>	<input type="radio"/>
Thermistor out of range	15	<input type="radio"/>	<input type="radio"/>	<input type="radio"/>	<input checked="" type="radio"/>	<input checked="" type="radio"/>	<input checked="" type="radio"/>	<input checked="" type="radio"/>
Power Failure detected	1	<input type="radio"/>	<input type="radio"/>	<input type="radio"/>	<input type="radio"/>	<input type="radio"/>	<input type="radio"/>	<input checked="" type="radio"/>
No code	0	<input type="radio"/>	<input type="radio"/>	<input type="radio"/>	<input type="radio"/>	<input type="radio"/>	<input type="radio"/>	<input type="radio"/>

MODEL CODE CHART

Model Numbers	Fill	Soak	Wash	Rinse	Spin	Complete	Pause
MAV546E	<input type="radio"/>	<input checked="" type="radio"/>	<input type="radio"/>	<input type="radio"/>	<input type="radio"/>	<input checked="" type="radio"/>	<input checked="" type="radio"/>
MAV5920 AGW (INT)	<input type="radio"/>	<input checked="" type="radio"/>	<input type="radio"/>	<input type="radio"/>	<input checked="" type="radio"/>	<input type="radio"/>	<input type="radio"/>
MAV508DE, MAV551E	<input type="radio"/>	<input checked="" type="radio"/>	<input type="radio"/>	<input type="radio"/>	<input checked="" type="radio"/>	<input type="radio"/>	<input checked="" type="radio"/>
MAV5758, MAV5858	<input type="radio"/>	<input checked="" type="radio"/>	<input type="radio"/>	<input type="radio"/>	<input checked="" type="radio"/>	<input checked="" type="radio"/>	<input type="radio"/>
MAV5920E	<input type="radio"/>	<input checked="" type="radio"/>	<input type="radio"/>	<input type="radio"/>	<input checked="" type="radio"/>	<input checked="" type="radio"/>	<input checked="" type="radio"/>
NAV8805	<input type="radio"/>	<input checked="" type="radio"/>	<input type="radio"/>	<input checked="" type="radio"/>	<input type="radio"/>	<input checked="" type="radio"/>	<input checked="" type="radio"/>

Troubleshooting Procedures

Due to possibility of personal injury or property damage, always contact an authorized technician for servicing or repair of this unit.



CAUTION

All safety information must be followed as provided in the Service Manual.



WARNING

To avoid risk of electrical shock, personal injury or death, disconnect power to unit before servicing.

Mechanical Control Version.

Noisy and/or Vibration/Walking

- Check for proper installation and leveling of unit.
- Legs properly adjusted and locked with no damage.
- Stabilizer rear legs secure and locking properly (not jamming).
- Solid and secure flooring.
- Check condition of belt.
- Check transmission for spin bearing noise.
- Check center tub seal.
- Check agitator for correct installation.
- Check the suspension springs are properly installed and lubricated.
- Check for loose screws on the cabinet.
- Check for damaged base.

Over Fill

- Check water pressure to washer should be a 20 PSI minimum.
- If water drips into machine while off, replace valve.
- Disconnect power cord. Replace Water Valve if it continues to flow.
- Check Pressure Switch for proper operation.
- Check Pressure Switch air hose for leaks damage or obstruction.

Wrong Water Temperature

- Check that both faucets are turned on fully.
- Make sure water heater is set to deliver a minimum of 120°F (49°C) hot water at the tap. Also check water heater capacity and recovery rate.
- Check for reversed inlet hoses at the faucet or water valve.
- With tub empty, select normal wash no ATC and Cold/Cold temperature setting. Let washer fill and check fill time and full tub temperature.
- Select normal wash no ATC and hot water temperature setting. Let washer fill and check fill time and full tub temperature. For extended wait time for hot water fill, instruct to purge water line for a hot wash.
- Select normal wash no ATC and Warm/Cold water temperature setting. Let washer fill and check fill time and full tub temperature.
- Check wiring at the Water Valve, Timer, and ATC.

Will Not Spin/Spin Speed Too Slow

- Check power supply to washer is between 108V to 132V with a load on the circuit.
- Check for out of balance clothes load.
- Check slow spin speed is not selected.
- Check condition of drive belt.
- Check drain system in the home is functioning properly.

- Check for blocked or kinked drain hose.
- Check for binding Tub Seal.
- Check brake is disengaging properly.
- Check motor slide and spring for proper movement.
- Check between tubs for something contacting spinner.
- Check for proper adjustment of the Thrust Bearing.
- Check for broken impeller on Drain Pump, washer should drain all water within 90 seconds.
- When washer passes all checks place a one pound unbalance weight in washer and check for 600 RPM. If washer fails, check brake and cam adjustments. Replace Transmission if brake and cam adjustments are ok.

Motor Not Running

- Check power supply to washer is between 108V and 132V during a load on circuit.
- Check if Lid Switch is functional. Lid must be closed before washer will operate.
- Check voltage going into, and out of timer to start and run windings, per ladder diagram.
- Check for 120 volts to start and run winding at motor per ladder diagram.
- Check for a blown motor thermal fuse.
- Check for obstructions in Drain Pump.
- Turn transmission pulley by hand. If locked in agitation direction, replace transmission.

No Water Fill

- Check to make sure water supply is turned on fully.
- Check electrical circuit and connections at the Water Valve, and Pressure Switch.
- Check for kinks in inlet hoses.
- Check for clogged inlet screens and water valve screens.
- Check Water Valves separately for fill.
- Check for low water pressure. May be dependent on pressure entering home. Variations may occur due to usage in the home at the time machine is used.
- Check for frozen pipes and hoses.
- Check hot and cold water valve voltage for 120 volts.
- If washer fills and drains at the same time, check for drain hose siphoning.

Will Not Drain

- Check for restricted drain system.
- In cold climates check for frozen drain hose.
- Check for broken impeller on Drain Pump. Washer should drain all water within 90 seconds.
- Check motor slide and spring for proper movement.

Component Testing Information



WARNING

To avoid the risk of electrical shock, personal injury, or death, disconnect power to unit before servicing, unless testing requires power.

Electronic Controls

Resistance and voltage checks of components listed below can be made at PS5 on the control board.

Note: When making resistance checks on the components listed below, washer must be unplugged and PS5 connector disconnected from control board.

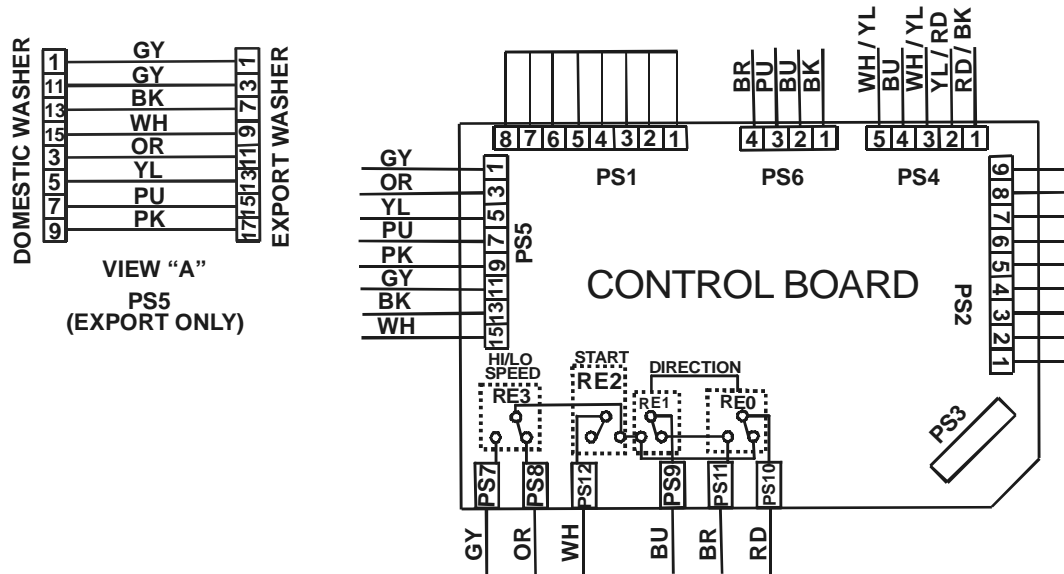

Illustration	Component	Test Procedure	Results
	AC Power	With the unit plugged in, check source voltage at Pin #15 WH and Pin #13 BK of PS5 on the control board.....	120 V AC
	Lid Switch	With the unit plugged in, check voltage at Pin #5 YL and Pin #15 WH of PS5.....	120 V AC
	Pressure Switch	With unit plugged in and the tub empty, check voltage at Pin #3 OR and Pin #15 WH of PS5.....	120 V AC
	Motor	Unplug washer, disconnect harness at PS5 and test from wire insertion side of harness. Run winding - PS7 GY and Pin #5 YL of PS5..... Start winding - PS9 BU and PS10 RD.....	1.5 ohms 4.0 ohms without capacitor
	Water Valves	Unplug washer, disconnect harness and test resistance from wire insertion side of harness. (Hot valve) Pin #9 PK of PS5 and Pin #3 OR of PS5..... (Cold valve) Pin #7 PU of PS5 and Pin #3 OR of PS5..... (Thermistor) Pin #1 GY and Pin #11 GY of PS5.....	1120 ohms 1120 ohms 53000 ohms @ 70F

Component Testing Information

⚠ WARNING

To avoid the risk of electrical shock, personal injury, or death, disconnect power to unit before servicing, unless testing requires power.

Mechanical Controls

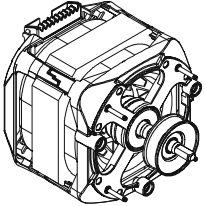
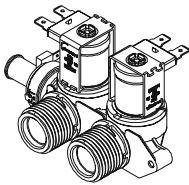
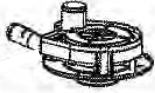
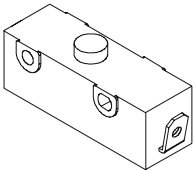
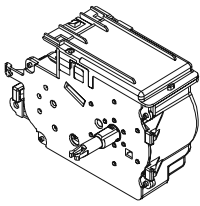
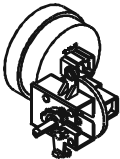
Illustration	Component	Test Procedure	Results
	1 Speed Motor CCW rotation when viewed from shaft end. 1/2HP 120V/60hz	Refer to Technical Data Sheet section "Internal Motor Diagram" and "Schematic" for wiring contacts.	
	Water valve 120V 50/60hz, 5 watts Cold Side 2.25 gpm, Hot Side 2.00 gpm, Mix 3.00 gpm at 20-120 psi	Measure resistance of terminals on each valve. Resistance across each valve.....	1000 Ω ± 10%
	Drain Pump	Verify Drain Pump is not clogged or damaged.	
	Lid Switch	Disconnect wire terminals from switch. Test terminals with switch closed..... Test terminals with switch open.	Continuity >1Ω Infinite 1MΩ
	Timer	Verify input and output voltage is present.	Refer to timing sequence chart on appropriate Technical Data Sheet.
	Pressure Switch	Do not disconnect the pressure hose from pressure switch to perform measurements. Measure resistance across the following terminals. Terminal 1 to 2..... Terminal 1 to 3.....	Refer to Technical Data Sheet for wiring diagram & schematic for correct contacts. Continuity >1Ω Infinite 1MΩ

Service Specifications

ATC (Automatic Temperature Control) Models

Model	Control Type	Description	Temperatures
MAVT346AWW MAV3757AWW MAV3758AWW MAV308DAWW MAV3905AWW	Mechanical	Energy Star temps, but not Energy Star rated. Electro-mechanical washer with Automatic Temperature Control shall have full tub water temperatures as follows:	Cold 58°±8° F Warm 85°±8° F Hot 115°±8° F
MAV3955EWW AAV8005EWW	Mechanical	Energy Star rated. Electro-mechanical washer with Automatic Temperature Control shall have full tub water temperatures as follows: (There shall be no warm rinse on Energy Star models)	Cold 58°±8° F Warm 85°±8° F Hot 115°±8° F
MAVT446AWW MAV4757AWW MAV4758AWW MAV4755AWW MAV408DAWW CW9505W	Mechanical	Standard Electro-mechanical washer with Automatic Temperature Control shall have full tub water temperatures as follows: (Where applicable, warm rinse is not controlled.)	Cold 75°±8° F Warm 95°±8° F OR Cold 58°±5° F Warm 85°±5° F
MAVT546EWW MAV5758EWW MAV5920EWW MAV551EEWW NAV8805EWW	Electronic	Energy Star rated. Electronic washer with Automatic Temperature Control shall have full tub water temperatures as follows: (There shall be no warm rinse on Energy Star models)	Cold 58°±5° F Warm 85°±5° F Hot 115°±5° F
MAV5920AGW	Electronic	Electronic washer with Automatic Temperature Control shall have full tub wash water temperatures as follows: (Warm Rinse temperature shall be 80°±5° F)	Cold 70°±5° F Warm 90°±5° F Hot 125°±5° F

Fabric Selection

Soil Level - Approximate Agitation Times, in minutes

	Light	Normal	Heavy	Extra Heavy
<u>Quick Wash</u> Gentle/Fast	2	4	6	8
<u>Hand Wash</u> Ex. Gentle/Slow	Intermittent 6	Intermittent 9	Intermittent 12	Intermittent 15
<u>Delicates</u> Gentle/Slow	6	9	12	15
<u>Permanent Press</u> Medium/Slow	9	12	15	21
<u>Regular</u> Medium/Fast	9	15	18	24
<u>Whites & Towels</u> Normal/Fast	9	15	18	24

Agitation Speeds

Gentle	58 opm (oscillations per minute)
Ex. Gentle	Intermittent 58 opm
Medium	Cycles between 3 minutes at 88 opm and 3 minutes at 58 opm
Normal	88 opm

Spin Speeds

Fast Spin	620 +/- 25 rpm (revolutions per minute)
Slow Spin	413 +/-17 rpm

Disassembly Procedures



WARNING

To avoid risk of electrical shock, personal injury or death, disconnect power to unit before servicing.

Console Disassembly

1. Disconnect power supply to unit.
2. Remove Cycle Selector Knob and Switch Knobs.

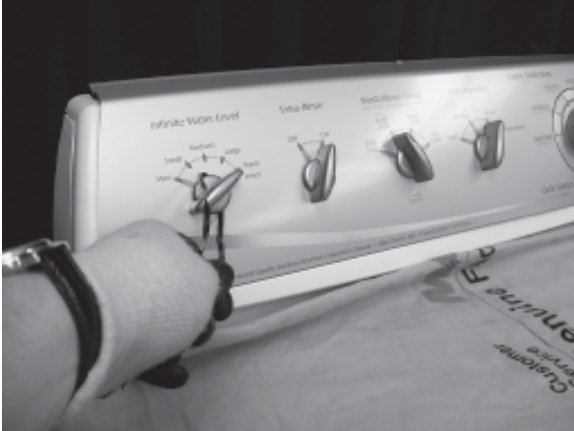

3. Remove three screws along the top of the Console and roll the Console forward.



4. Disconnect and remove Rocker Switches from Console.



5. Disconnect all wiring harness connectors from the Circuit Board.

NOTE: Wear an Anti Static Wrist Strap and ground yourself before working with Electronic Control Boards. Always handle boards by the edge and don't touch discreet components.



6. Depress the PCB locking tab and remove Circuit Board.

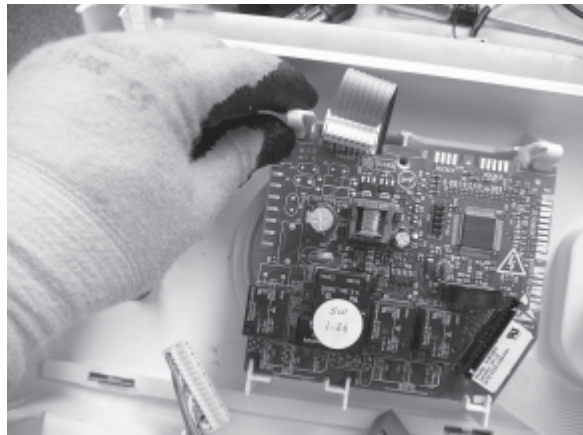

7. Remove Switches by lifting locking tab and rotating Switch to align with hole molded in Console.

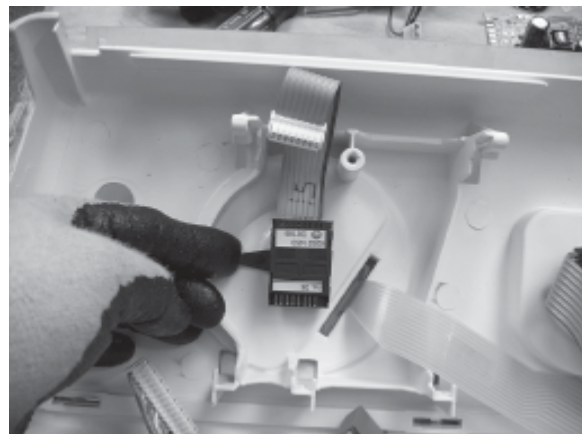

Disassembly Procedures



To avoid risk of electrical shock, personal injury or death, disconnect power to unit before servicing.

8. Remove Pressure Switch Hose and wiring connector from Pressure Switch.



NOTE: There will be water remaining in the hose from the last cycle.



9. Lift Pressure Switch locking tab and rotate switch to remove.
10. Remove Facia from Console.



4. Remove Belt.



Drain Pump/Belt Removal

1. Disconnect power supply to unit.
2. Remove back Cover.
3. Remove Drain Hose Clamps.

NOTE: There will be water remaining in the hose from the last cycle.



5. Remove three screws retaining Drain Pump.



Disassembly Procedures



To avoid risk of electrical shock, personal injury or death, disconnect power to unit before servicing.

Top Cover Removal

1. Disconnect power supply to unit.
2. Insert a plastic putty knife between the Top Cover and Front Panel. Press the locking clip to release the Top Cover. Repeat for both sides. Support lid with free hand and rotate top until it comes to rest on hinge stop.



5. Remove Lid Switch Striker by removing screw from the Lid side.



Hinge/Lid Removal

1. Disconnect power supply to unit.
2. Lift Top Cover, see "Top Cover Removal" procedure.
3. Remove Hinge screw on each side.



Lid Switch Removal

1. Disconnect power supply to unit.
2. Lift Top Cover, see "Top Cover Removal" procedure.
3. Remove two screws retaining Lid Switch.



4. Remove Hinge from Pivot Post.



4. Remove Lid Switch from housing.



Disassembly Procedures



To avoid risk of electrical shock, personal injury or death, disconnect power to unit before servicing.

Water Valve Removal

1. Disconnect power supply to unit.
2. Lift Top Cover, see "top Cover Removal" procedure.
3. Remove retaining screw on back panel.



4. Lift Water Valve to align with cutout in back cabinet.



Dispenser Removal

1. Disconnect power supply to unit.
2. Lift Top Cover, see "Top Cover Removal" procedure.
3. Relieve tension on Dispenser retaining tab.



Front Panel Removal

1. Disconnect power supply to unit.
2. Lift Top Cover, see "Top Cover Removal" procedure.
3. Remove two screws, 1 each side on Front Panel top edge.



Disassembly Procedures



To avoid risk of electrical shock, personal injury or death, disconnect power to unit before servicing.

Motor Removal

1. Disconnect power supply to unit.
2. Lift Top Cover, see “Top Cover Removal” procedure.
3. Remove Front Panel, see “Front Panel Removal” procedure.
4. Remove Motor ground wire.



5. Remove Motor Shield.



6. Remove Motor wire harness connector.

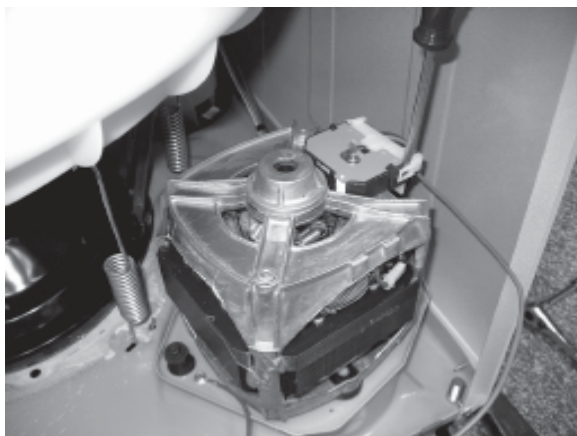

7. Remove three screws retaining Motor to Base.

Flume/Thermistor Removal

1. Disconnect power supply to unit.
2. Remove Console, see “Console Disassembly” procedure.
3. Remove Flume screw from top of Top Cover.



4. Lift Top Cover, see “Top Cover Removal” procedure.
5. Remove two Flume retaining screws from bottom of Top Cover.



6. Remove hose clamp and Flume/Diverter Hose.



Disassembly Procedures



To avoid risk of electrical shock, personal injury or death, disconnect power to unit before servicing.

Tub Top Removal

1. Disconnect power supply to unit.
2. Lift Top Cover, see "Top Cover Removal" procedure.
3. Press down on Tub Top and swing locking latch away from Outer Tub. Repeat for all latches
4. Remove Tub Top.

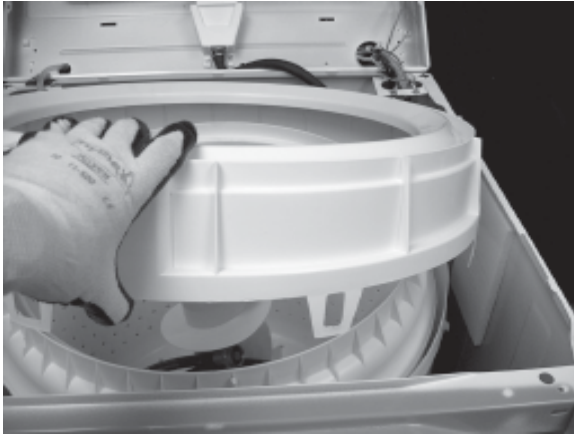

6. Remove screw located in the center of the Agitator/Auger assembly.



7. Remove Agitator Auger from Agitator Base.



Agitator/Spinner/Outer Tub/Transmission Removal

1. Disconnect power supply to unit.
2. Remove Drain Pump hoses and Belt, see "Drain Pump/Belt Removal" procedure steps 1 - 4.
3. Lift Top Cover, see "Top Cover Removal" procedure.
4. Remove Tub Top, see "Tub Top Removal" procedure.
5. Unsnap Fabric Softener Dispenser from Agitator.



8. Lift Agitator Base from Washer.



Disassembly Procedures



To avoid risk of electrical shock, personal injury or death, disconnect power to unit before servicing.

- 9. Remove four screws retaining Spinner (Inner Tub).
- 10. After Spinner (Inner Tub) is removed, use Spanner Wrench and Seal Nut tool to remove Seal Nut.

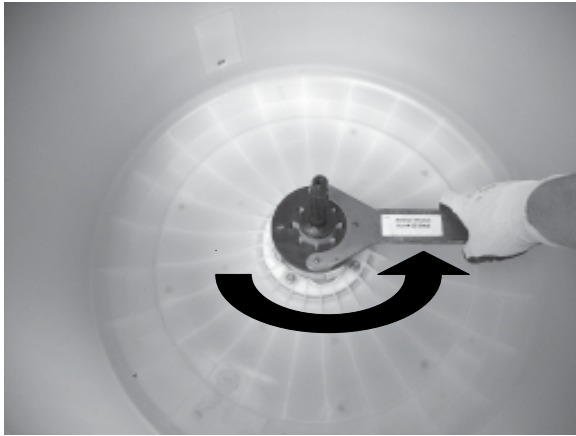

- 11. Remove gasket from Hub.

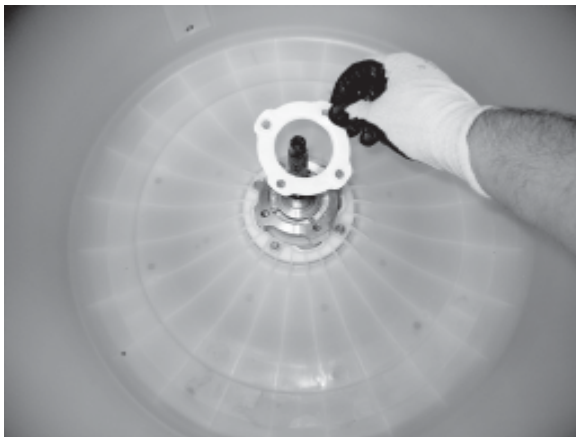

- 12. Use Spanner Wrench to remove Hub.

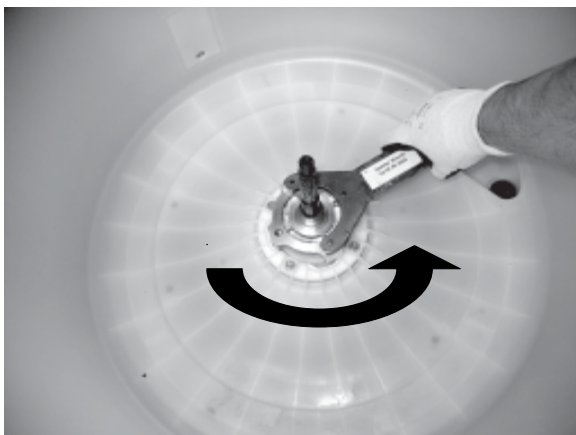

- 13. Remove Pressure Switch Hose from fitting on Outer Tub.



- 14. Remove Suspension Springs using the spring removal tool. Be careful not to let Tub and Transmission assembly tip over.



Disassembly Procedures

 **WARNING**

To avoid risk of electrical shock, personal injury or death, disconnect power to unit before servicing.

15. Be sure to lay down a protective pad before removing assembly. Remove Outer Tub and Transmission assembly from Cabinet. Turn assembly over and stand on protective pad on Outer Tub rim.



17. Remove screws retaining Outer Tub to Transmission Support.

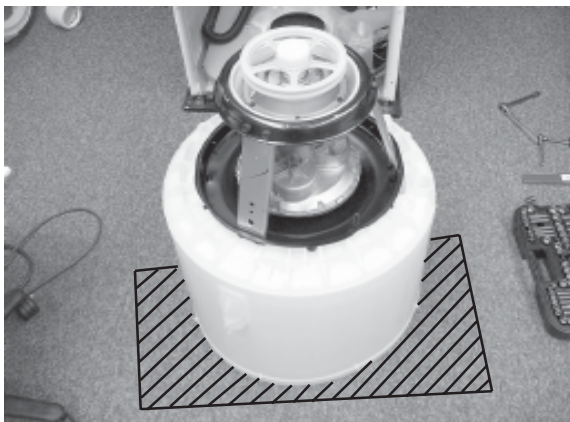
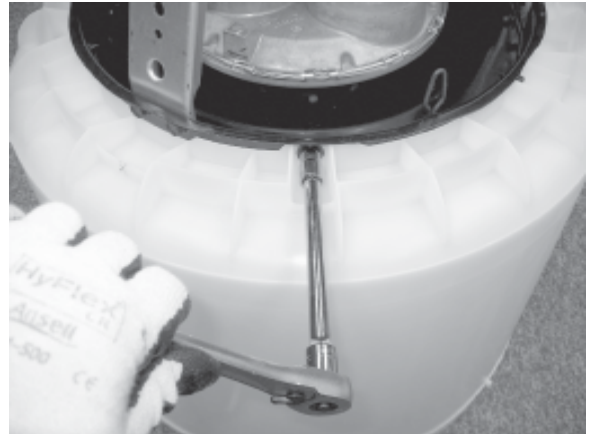

Tub Seal/Transmission Disassembly

1. Disconnect power supply to unit.
2. Remove Transmission Assembly from washer, see "Agitator/Spinner/Outer Tub/Transmission Removal" procedure.
3. Remove Transmission from Transmission Support by removing screws on Verticle Support Legs.

16. Mark location of Transmission Support with respect to the Outer Tub for ease of assembly.

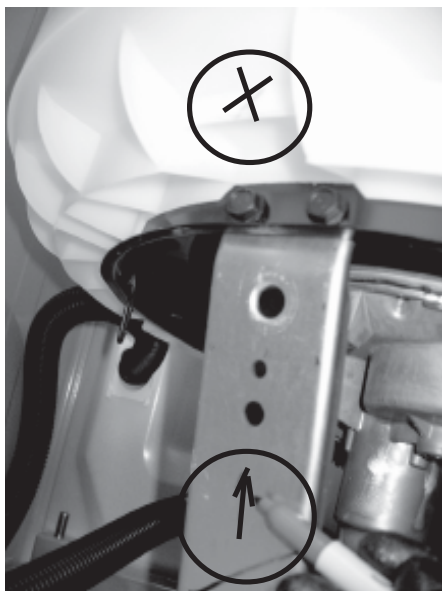

Disassembly Procedures



To avoid risk of electrical shock, personal injury or death, disconnect power to unit before servicing.

4. Remove screws retaining the Tub Seal.

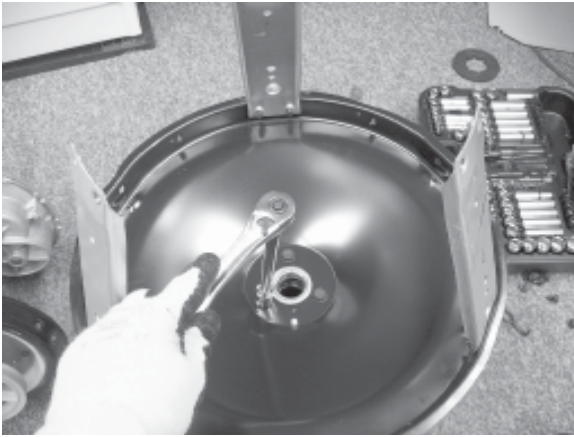

Drive Pulley and Cam Removal

The Drive Pulley and Cam are located below the Brake assembly on the drive shaft. A Washer and Retaining Ring secure the Pulley and Cam on the drive shaft. A plastic Dust Cap snaps to the underside of the Pulley to keep the Cam surfaces clean. These components can be removed by tipping the Washer back to access bottom side of unit.

1. Disconnect power supply to unit.
2. Remove (pry off) Dust Cap from under side of pulley.
3. Remove Retaining Ring and Washer from end of drive shaft.
4. Firmly pull Lower Cam off of the drive shaft splines, then slide the other parts off of the shaft.



Models are equipped with a plastic Drive Pulley which has the upper Cam molded onto the bottom of the Hub. The purpose of the Pulley and Cam arrangement is to drive the Clutch assembly during the agitate and spin cycle, and to disengage the Brake assembly during the spin cycle.

The Drive Pulley slips over the drive shaft and rests against a series of Washers, a Thrust Bearing, and a large washer type Spacer. The Spacer locates against the bottom of the Brake Rotor and Lining assembly. The Lower Cam slips over the end of the drive shaft where splines formed in the Cam engage with mating splines on the drive shaft end. This imparts a direct drive from the Cam to the drive shaft. A shoulder molded on the bottom of the Pulley hub engages "dogs" formed on the sides of the Lower Cam, and will drive it and the drive shaft in either direction.

Brake Disassembly

The Brake assembly is located inside the domed area of the Suspension Housing and consists of the following components: Brake Spring Retainer, Brake Spring, Rotor and Lining assembly, and the Brake Stator.

CAUTION: The brake assembly has a compressive spring force of approximately 200 pounds. Use Brake Removal Tool LA-2004 or 12002012.

1. Disconnect power supply to unit.
2. Remove Transmission Assembly from Washer, see "Agitator/Spinner/Outer Tub/Transmission Removal" procedure.
3. Remove the Drive Pulley and Cam components, see "Drive Pulley and Cam Removal" procedure.
4. Pull out and remove "U" retainer from Brake Removal Tool.
5. Slip the splined end of the drive shaft into hole located in the tool inner plunger.
6. Looking at the side of the tool, align slots on tool barrel and holes in tool plunger between splines and chamfered shoulder of shaft.
7. Slip "U" retainer through tool slots and holes capturing the drive shaft behind the chamfered shoulder.

NOTE: Be sure "U" retainer is completely through both sides of tool.

8. Tighten tool nut to compress Brake Spring until Transmission turns freely.
9. Remove the six (6) screws which secure the Brake Stator and Snubber to the underside of the Suspension Housing.
10. Loosen tool nut until the Brake Spring reaches its free length.
11. Remove "U" retainer from tool and remove tool from drive shaft.
12. Remove Brake components.

NOTE: Be sure not to get any grease on Brake Snubber, Stator, or Brake Lining.

Disassembly Procedures



To avoid risk of electrical shock, personal injury or death, disconnect power to unit before servicing.

Tub Seal Replacement

1. Disconnect power supply to unit.
2. Remove Tub Seal, see "Tub Seal/Transmission Disassembly" procedure.
3. Make sure both mating surfaces on Transmission shaft are free of foreign matter, then clean both surfaces with an alcohol saturated cloth.
4. Apply a thin layer of grease to the locations indicated in the following images to Seal Nut and Triple Lip Seal before installing. Insure that no grease gets on Snubber, Stater, or Brake Lining.

NOTE: Do not use any agent other than alcohol to clean the mating surface. Do not use any lubricant other than Silicone Grease, part number 203959.

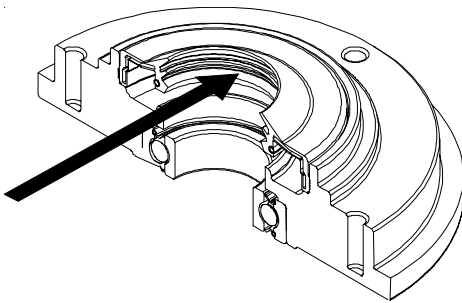

Apply grease to location indicated with arrow on Triple Lip Seal.

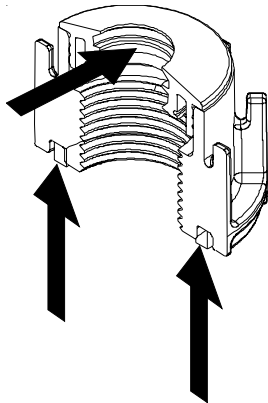

Apply grease to locations indicated with arrows on Seal Nut.

Spin Bearing Replacement

1. Disconnect power supply to unit.
2. Press the Spin Bearing out of the cavity from the opposite side of the housing.
3. When installing the replacement bearing into the housing cavity, be sure to press against the outer race of the bearing to avoid damage to the bearing shield and causing premature failure.

Oil Seal Replacement

The Oil Seal is located in the spline end of the drive tube. The Oil Seal can be replaced without removing or disassembling the Transmission.

1. Disconnect power supply to unit.
2. Tip Washer back to access bottom side and remove Drive Belt, Dust Cap, Retaining Ring, Washer, Cam, Drive Pulley, Thrust Bearing and Spacer, see "Drive Pully and Cam Removal" procedure.
3. Remove the Brake assembly to access the Oil Seal, see "Brake Disassembly" procedure.
4. Use a thin, flat bladed screwdriver to carefully pry the old Oil Seal out.
5. Place the drive washer (tool number 14242) and the new Oil Seal over the seal protector.
6. Remove the cone-shaped end from the seal protector tool and slide the tool, drive washer, and new Oil Seal over the drive shaft up to the seal cavity.
7. Slide the Transmission seal driver (tool number 14242) over the drive shaft until it makes contact with the drive washer. Use the impact sleeve of the tool to "tap" the Oil Seal into the end of the drive tube.

Snubber/Brake Assembly

1. Disconnect power supply to unit.
2. Apply a small amount of grease to the splines of the Drive Tube and Rotor.

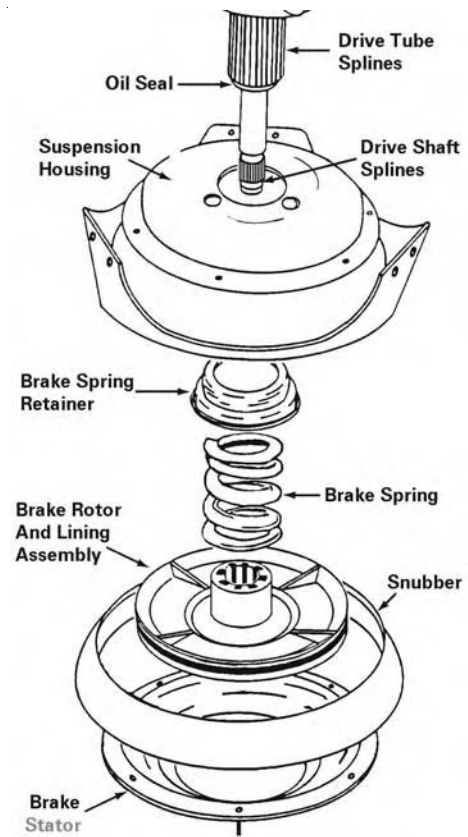

Disassembly Procedures



To avoid risk of electrical shock, personal injury or death, disconnect power to unit before servicing.

NOTE: This is a dry operating Brake assembly. Make sure no oil or grease comes in contact with the mating surfaces of the Brake Lining, Brake Stator, or Snubber.

3. Be sure to wash hands to remove any dirt or grease before handling Snubber. Clean new Snubber with alcohol before installing. When installing new Snubber, insure Snubber is centered.
4. Install Stator by locating the dimple on the Stator, and tightening the screw next to the dimple first.

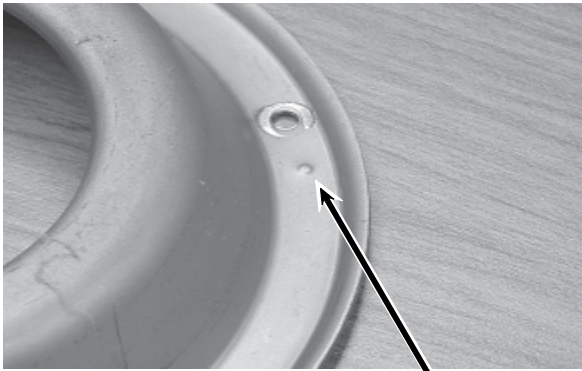

Dimple

5. Next tighten the screw 180 degrees across from the dimple. Tighten remaining screws. Remove brake tool.
6. Reinstall Drive Pulley, Cam, Washer, Retaining Ring, and Dust Cap.



The Brake assembly, as well as the Snubber, is held in position by the Brake Stator which is secured to the underside of the Suspension Housing by six (6) mounting screws.

Spring pressure forces the Rotor and Lining assembly down on the Brake Stator and prevents the Transmission from turning during agitation.

As stated previously, the Drive Pulley and Cams provide a cam action which raises the Drive Pulley during the counterclockwise (spin) direction of the Motor. When the

Drive Pulley hub travels upward, it compresses the Brake Spring and moves the Rotor and Lining assembly up the drive tube disengaging it from the Stator. The Transmission is now free to spin.

Splines in the Brake Rotor hub mesh with splines on the drive tube end to provide positive vertical movement for the Rotor and Lining assembly. The splines are greased for ease of movement.

Installing Thrust Bearing

1. Thrust Bearing and Spacer are to be assembled as shown.

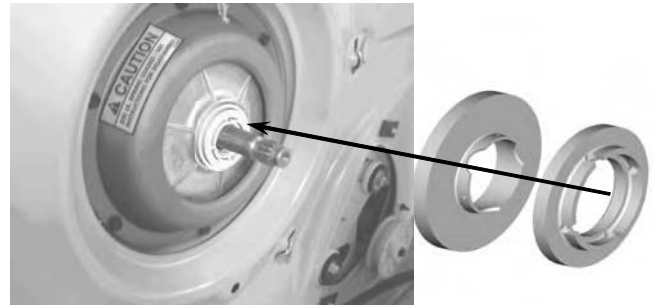

2. Apply a thin layer of **grease** between the contacting surfaces of the Lower Cam and the Drive Pulley.

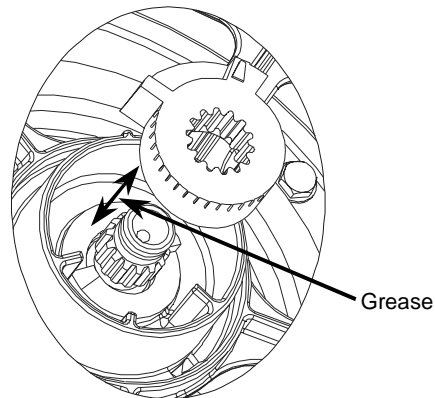

Base Replacement

1. Disconnect power supply to unit.
2. Remove Drain Pump and Belt, see "Drain Pump/Belt Removal" procedure.

NOTE: There may be water remaining in the hose from the last cycle.

3. Lift Top Cover, see "Top Cover Removal" procedure.
4. Remove Front Panel, see "Front Panel Removal" procedure.
5. Remove Motor, see "Motor Removal" procedure.

Disassembly Procedures



To avoid risk of electrical shock, personal injury or death, disconnect power to unit before servicing.

6. Remove Pressure Switch hose, Tub Springs and Outer Tub/Transmission assembly, see "Agitator/Spinner/Outer Tub/Transmission Removal" procedure steps 13, 14 and 16.
7. Remove screws from sides and rear of unit around bottom, connecting Cabinet to Base. Remove Cabinet from Base and set aside. Be sure to lay down a protective pad before removing Tub and Transmission assembly from Base. Remove Tub and Transmission assembly, turn over and lay on protective pad.
8. Remove Dust Cap, Retaining Ring, Washer, Cam, and Drive Pulley from bottom of Transmission, see "Drive Pulley and Cam Removal" procedure.
9. Remove Brake assembly from Transmission, see "Brake Disassembly" procedure steps 4 - 12. Remove old Snubber from Transmission.
10. Install new Snubber, see "Snubber/Brake Assembly" procedure steps 3 - 6. Insure Snubber is centered.
11. Turn new Base upside down and apply grease at bottom of the spring hole pockets to eliminate noise between Spring and Base interaction.

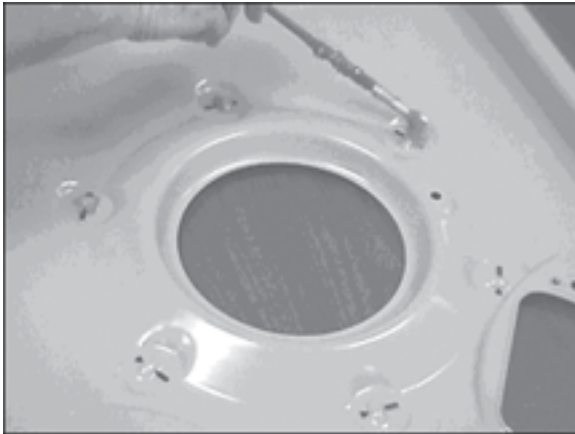

12. Clean the dome area of new Base with alcohol then apply corn starch.



13. Reinstall Motor and Pump to new Base.

14. Transfer Transmission and Outer Tub onto new Base. Attach Suspension Springs using spring tool to avoid over stretching the Springs.
15. Transfer Cabinet shell onto new Base and reassemble Washer. Be sure to reattach Pressure Switch Hose to back of Tub, Drain Pump Hoses with clamps to Drain Pump, and wire harness to Motor. Check all hoses and wires to make sure they are secure.
16. Test Washer.

Transmission Operation

When the Drive Pulley rotates **CLOCKWISE**, the upper and lower cams are designed to nest together which allows the Drive Pulley to remain in position on the drive shaft. The Brake remains engaged and the Drive Pulley will turn the lower cam and drive the shaft to cause the Transmission to agitate.

When the Drive Pulley rotates **COUNTERCLOCKWISE**, the upper cam and Pulley ride up the lower cam approximately 3/16 of an inch before the driving shoulders on the Pulley hub engage the "dogs" on the lower cam.

This causes the top of the Pulley hub to push against the Spacer which compresses the Brake Spring and lifts the Brake Rotor and Lining assembly off the Brake Stator. The Brake is disengaged and the Pulley will turn the lower cam and drive shaft to cause the Transmission to spin.

Determine Brake Rotor Condition

Watch the Spacer on the Encapsulated Thrust Bearing. If the Spacer rotates with the Pulley, the Brake is functioning properly. If the Spacer stays stationary while rotating the Pulley to release the Brake, the Brake Rotor must be replaced.

After reassembling the Washer, fill the Tub with water and select a spin to drain the Tub. When the cycle is finished, verify the adjustment of the Brake, and verify the Spacer on the Thrust Bearing rotates with the Pulley.

Brake Adjustment

1. After reassembling the components on the drive shaft, it may be necessary to pull down on the shaft to take the endplay out before the Thrust Washer and Retaining Ring can be reinstalled.

NOTE: Each time the cams are reassembled on the drive shaft, the point in the cam rise where the Brake disengages the Stator should be checked and adjusted as necessary. Reference points have been molded into the Pulley as an aid in checking the point of Brake disengagement.

Disassembly Procedures



To avoid risk of electrical shock, personal injury or death, disconnect power to unit before servicing.

To Check Brake Disengagement

1. Manually rotate the Drive Pulley in a slow counter-clockwise direction until the Brake starts to release and the Transmission begins to turn.
2. Position the "Reference Cam Arrow" midway between the "Min Pulley Hub Reference" and the "Max Pulley Hub Reference" markers located on the Pulley.

If the position of the Cam Arrow to the Pulley Hub ***is not*** within these parameters ***adjustment is required***.

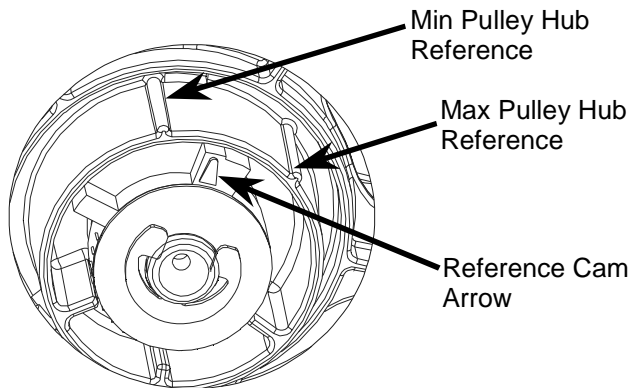

To Adjust Brake Disengagement

1. If the position of the Cam Reference Arrow is ***less than the Min Pulley Hub reference mark***, remove the standard (.062 thickness) Thrust Washer and replace it with a thinner (.032 thickness) Thrust Washer. Recheck disengagement 3 times to verify proper adjustment.
2. If the position of the Cam Reference Arrow is ***more than the Max Pulley Hub reference mark***, add a (.032 thickness) Thrust Washer to the standard Thrust Washer. Recheck disengagement 3 times to verify proper adjustment.

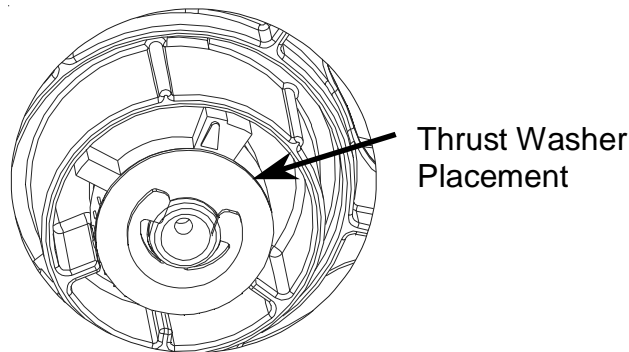

Appendix A

NOTES

Automatic Washing Machine

Laveuse automatique/Lavadora automática

Installation Instructions/Instructions d'installation/Instrucciones de Instalación

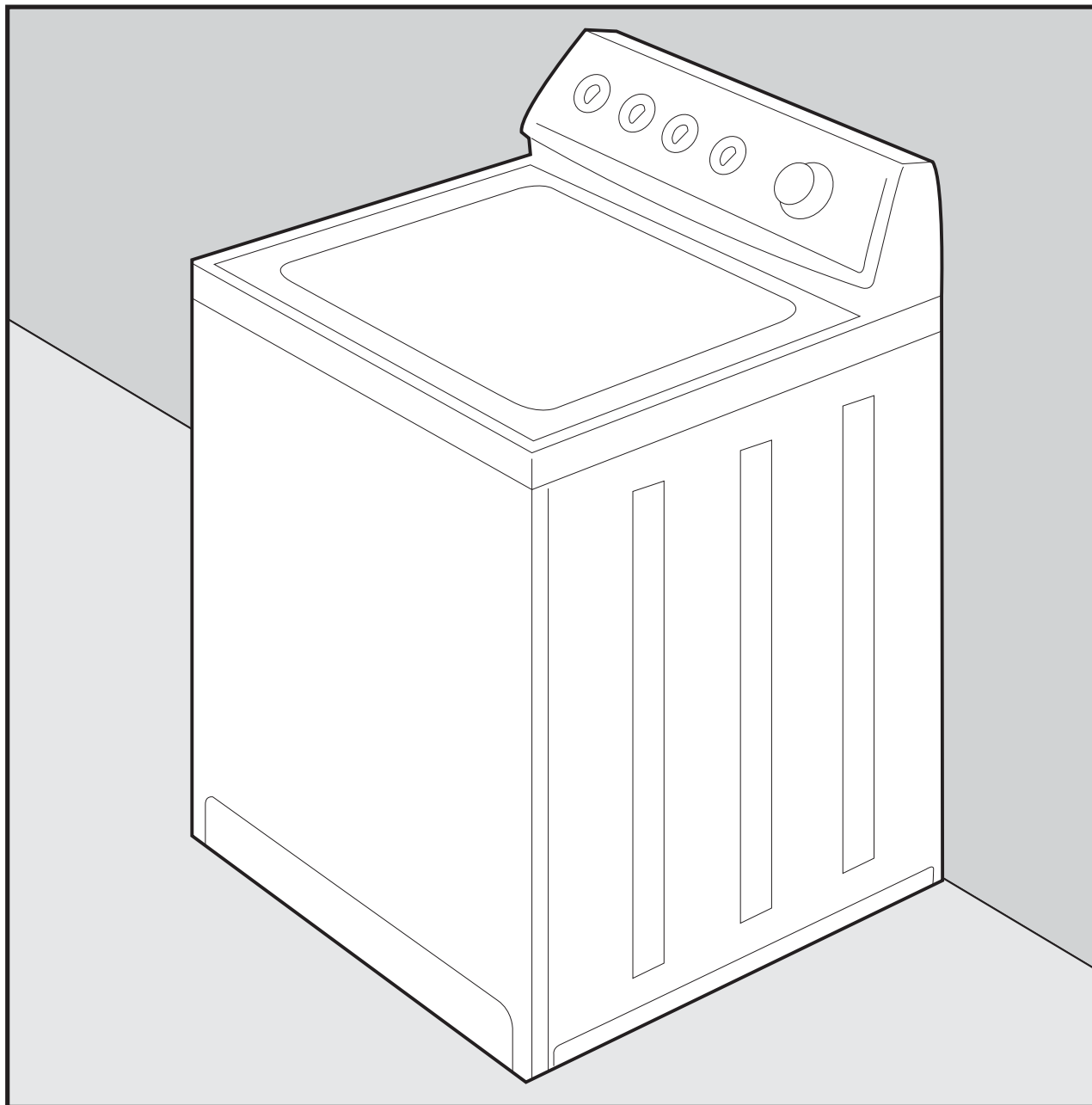

Printed in USA

©2003 Maytag Corporation

2201432 Rev A

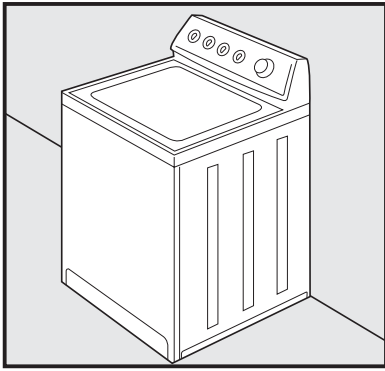

Automatic Washing Machine Laveuse automatique Lavadora automática

Installation Instructions/Instructions d'installation/ Instrucciones de Instalación

Please read all installation instructions and requirements before installing.

For your safety and the proper operation of your new washer, the washer must be installed in accordance with all the installation requirements.

C A U T I O N S

- Read operations manual before operating washer.
- Do not connect washer to power source until installation is complete.
- Locate washer in dry weather-proof area that can support weight of fully loaded machine.
- Power outlet must be grounded 120V AC 60 HZ. Do not use an extension cord.

Veuillez lire toutes les instructions et exigences avant l'installation.

Pour votre sécurité et le bon fonctionnement de votre nouvelle laveuse, cette dernière doit être installée selon toutes les exigences requises.

M I S E S E N G A R D E

- Lisez le manuel d'utilisation avant de mettre la laveuse en marche.
- Ne branchez pas la laveuse tant que l'installation n'est pas terminée.
- Installez la laveuse dans un endroit sec, à l'abri des intempéries, et pouvant supporter le poids de la laveuse remplie au maximum.
- La prise doit être de 120 V CA, 60 Hz, et mise à la terre. N'utilisez pas de cordon prolongateur.

Por favor lea todas las instrucciones y requerimientos antes de la instalación.

Para su seguridad y el funcionamiento apropiado de su nueva lavadora, ésta debe ser instalada de acuerdo con todos los requerimientos de instalación.

P R E C A U C I O N E S

- Lea el manual de funcionamiento antes de poner en marcha la lavadora.
- No enchufe la lavadora hasta que no se haya completado la instalación.
- Instale la lavadora en un lugar seco al abrigo del mal tiempo y que pueda soportar el peso de la lavadora completamente llena de ropa.
- El tomacorriente debe ser de 120 V CA, 60 Hz y puesto a tierra. No use un cordón de extensión.

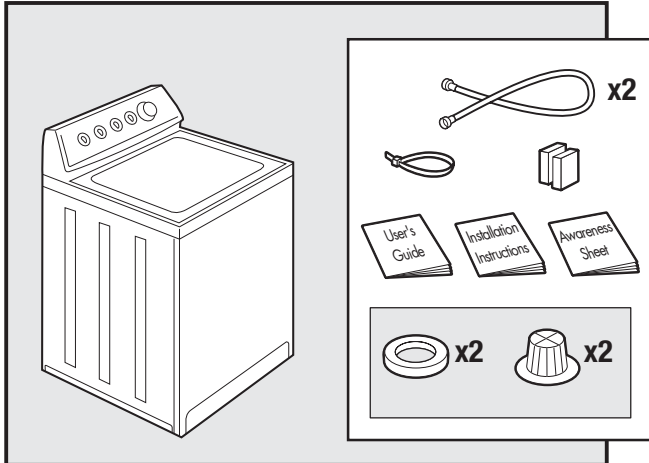

Items Included/Articles inclus/Artículos Incluidos

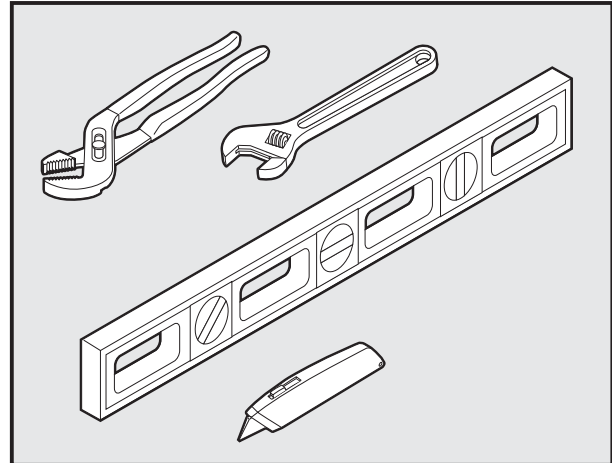

Tools Needed/Outils nécessaires/Herramientas Necesarias

Installation Requirements/Exigences d'installation/Requerimientos de Instalación

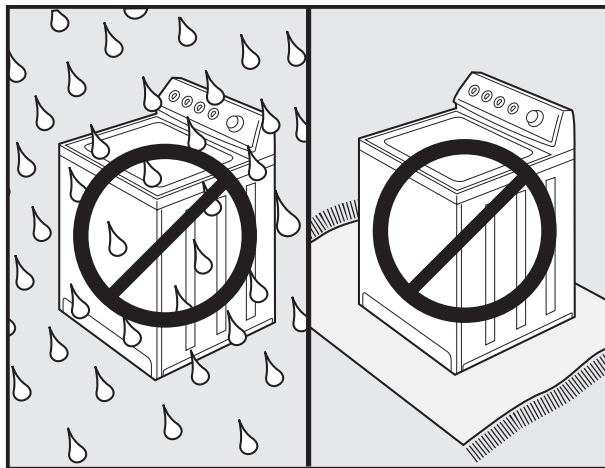

Do not place washer in the weather or on carpet./Ne placez pas la laveuse sur un tapis et ne l'exposez pas aux intempéries./No coloque la lavadora sobre una alfombra ni expuesta a las inclemencias del tiempo.

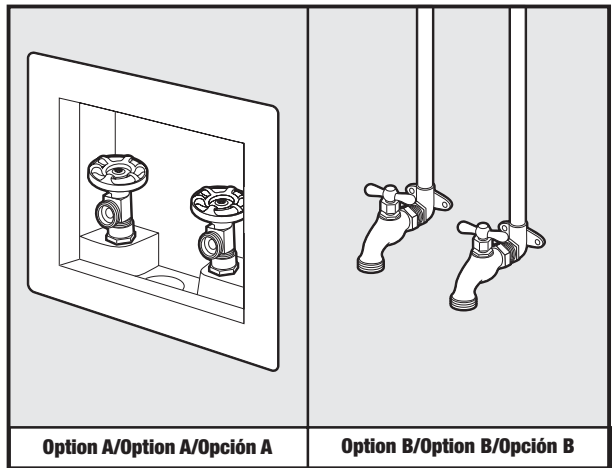

Option A/Option A/Opción A

Option B/Option B/Opción B

Minimum 25-125 psi water pressure at machine/Pression minimale à l'arrivée d'eau de la laveuse : 25 - 125 lb/po²/Presión mínima del agua de entrada a la lavadora: 25-125 lbs./pulg.²

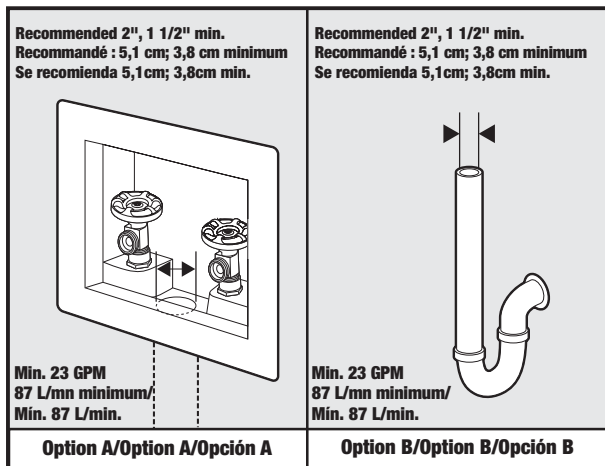

Recommended 2", 1 1/2" min.
Recommandé : 5,1 cm; 3,8 cm minimum
Se recomienda 5,1cm; 3,8cm min.

Min. 23 GPM
87 L/mn minimum/
Min. 87 L/min.

Option A/Option A/Opción A

Recommended 2", 1 1/2" min.
Recommandé : 5,1 cm; 3,8 cm minimum
Se recomienda 5,1cm; 3,8cm min.

Min. 23 GPM
87 L/mn minimum/
Min. 87 L/min.

Option B/Option B/Opción B

Minimum of 23 gallons per minute; Recommended 2" diameter standpipe/
Minimum de 23 gallons par minute; tuyau vertical d'évacuation – diamètre recommandé : 2 po//Mínimo de 23 galones por minuto; se recomienda un tubo vertical de evacuación de 2" de diámetro

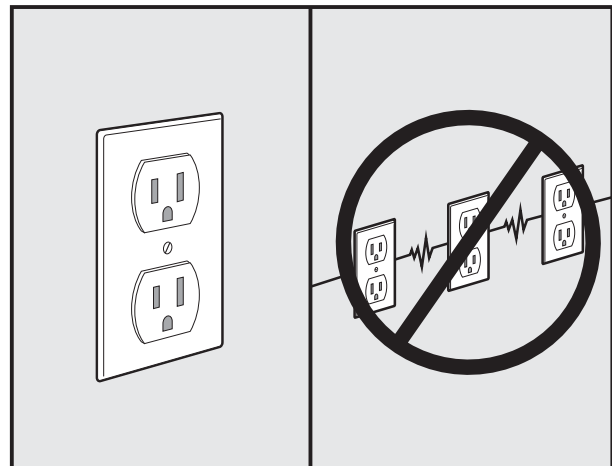

Washer outlet should be on its own circuit./La prise de la laveuse doit être sur un circuit indépendant./El tomacorriente de la lavadora debe estar en un circuito independiente.

Installation/Installation/Instalación

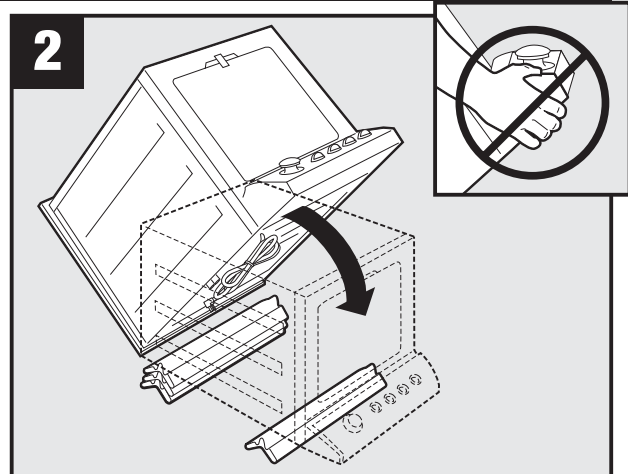
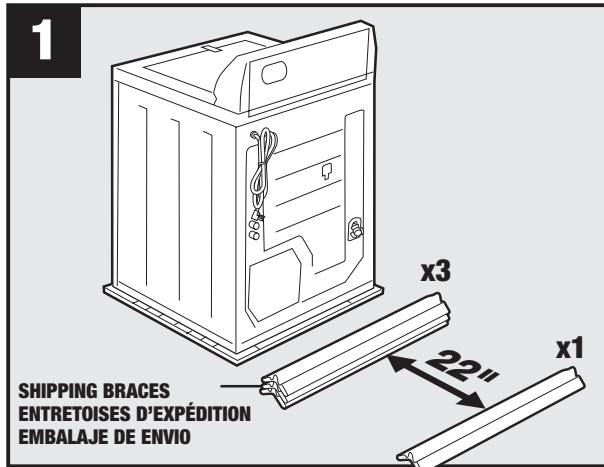

Gently lay washer on its back; take care not to hold the control panel./
Couchez doucement la laveuse sur l'arrière, sans la tenir par le tableau de commande./
Coloque delicadamente la lavadora sobre su parte trasera, teniendo cuidado de no sujetarla del panel de control.

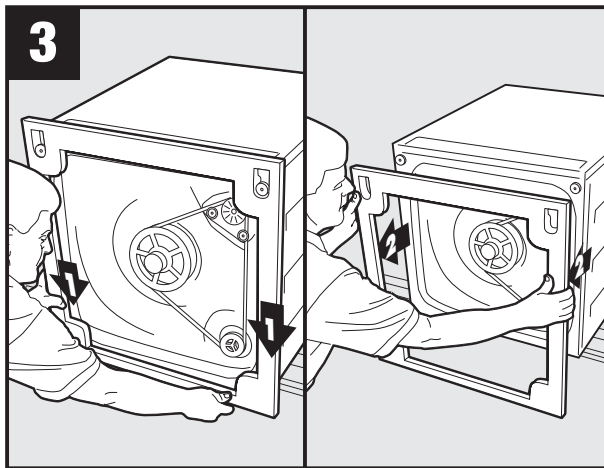

Press down and pull off plastic crate base./Abaissez et enlevez la palette en plastique./Empuje hacia abajo y retire la base de plástico de la caja.

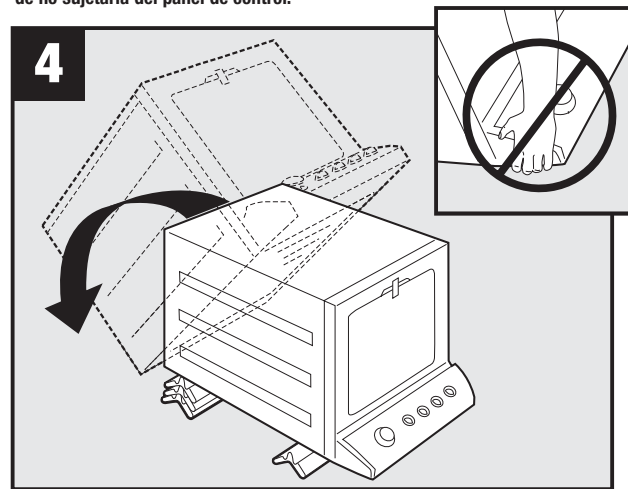

Gently return to upright position; take care not to hold the control panel./
Relevez doucement la laveuse, sans la tenir par le tableau de commande./
Vuélvala delicadamente a la posición vertical, teniendo cuidado de no sujetarla del panel de control.

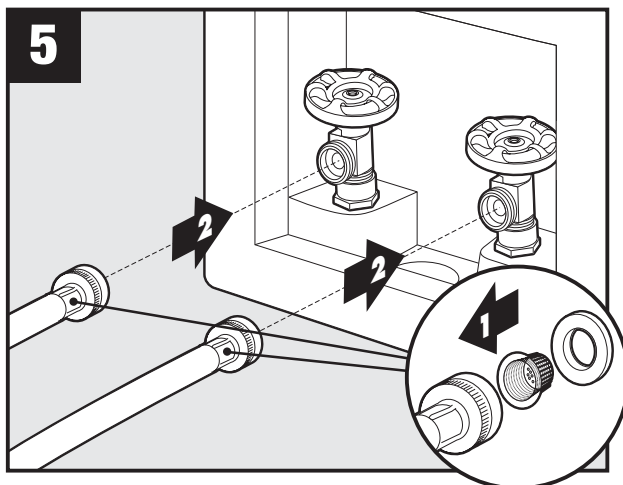

Place screens and washers in hoses./Installez les tamis et les joints dans les tuyaux./Coloque las mallas y arandelas en las mangueras.

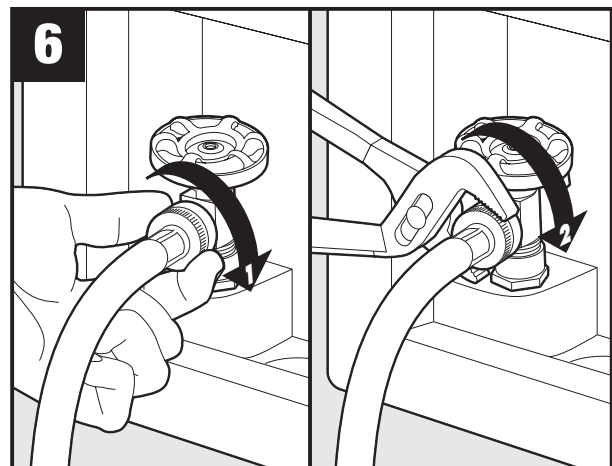

Fasten to faucets and tighten with pliers./Fixez les tuyaux aux robinets et serrez-les avec des pinces./Instale las mangueras en las llaves y apriete con pinzas.

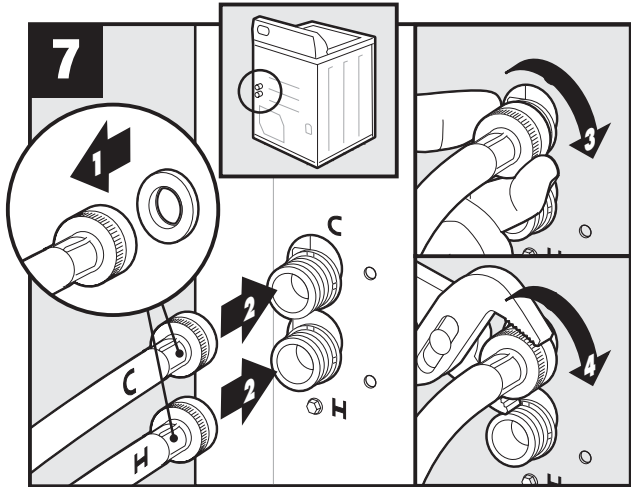

Place washers in hoses and attach to machine; take care to match up the hot and cold hoses to the correct inlet valve./Mettez les joints dans les tuyaux et fixez-les à la laveuse, en faisant correspondre les tuyaux d'eau chaude et d'eau froide aux robinets appropriés./Coloque las arandelas en las mangueras e instálelas en la lavadora, teniendo cuidado de hacer coincidir las mangueras del agua caliente y fría con las válvulas de admisión correctas.

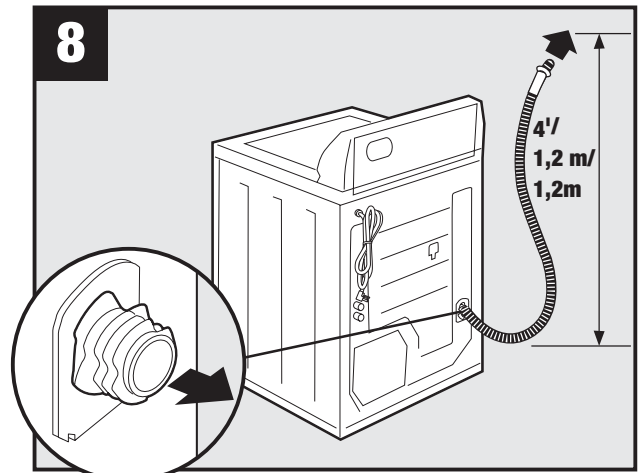

Pull out the drain hose until it stops, approximately 4 ft./Tirez sur le tuyau d'évacuation au maximum, soit environ de 4 pi./Tire de la manguera de desagüe hasta que se detenga, aproximadamente 4 pies.

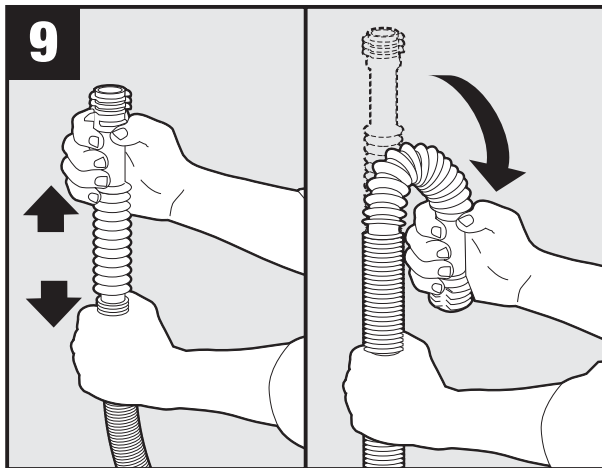

Fully extend the flexible section and form into a "C"./Étirez la section flexible et formez un « C »./Extienda completamente la sección flexible y forme una "C".

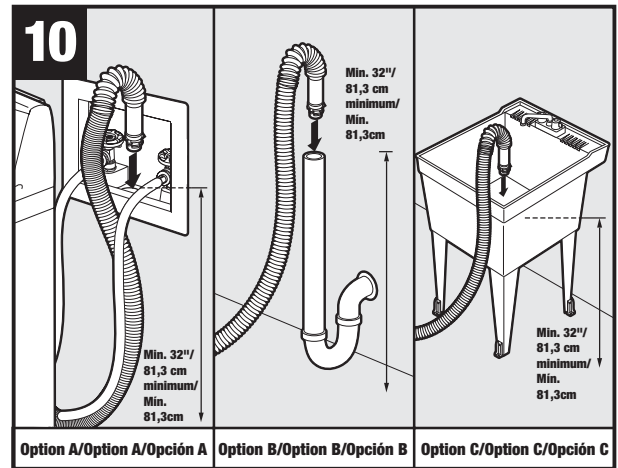

Fully insert cuff into drain pipe, approximately 3 in., or drape over sink rim./ Insérez complètement l'extrémité du tuyau d'évacuation dans le tuyau vertical, d'environ 3 po, ou placez-le sur le bord de l'évier./Instale completamente el extremo en la tubería de desagüe, aproximadamente 3 pulg., o colóquela sobre el borde del fregadero.

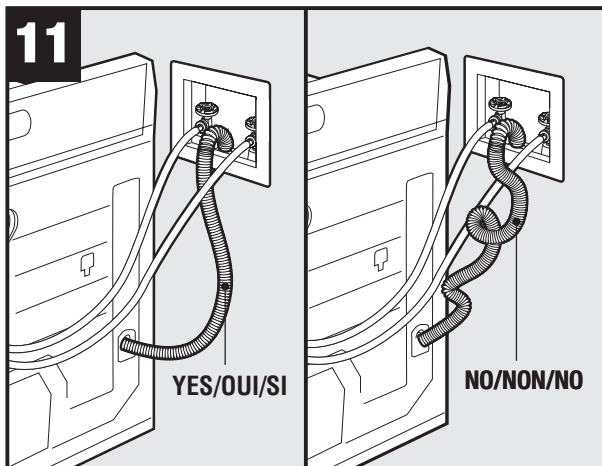

Ensure hose is not kinked./Le tuyau ne doit pas être entortillé ni plié./Asegúrese de que la manguera no esté torcida.

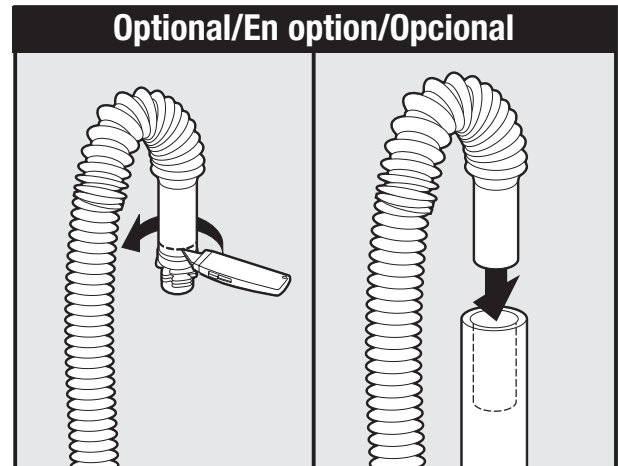

If the cuff of the hose does not fit into your stand pipe, cut off as shown./Si l'extrémité du tuyau ne pénètre pas dans le tuyau vertical, coupez-la, comme il est illustré./Si el extremo de la manguera no calza en su tubo vertical de evacuación, córtela como se muestra.

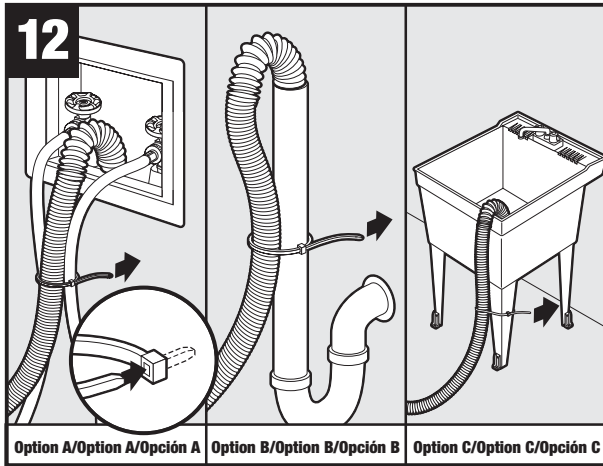

Option A/Option A/Opción A Option B/Option B/Opción B Option C/Option C/Opción C

Secure drain hose with tie strap as shown./Fixez le tuyau d'évacuation avec l'attache, comme il est illustré./Asegure la manguera de desagüe con la atadura como se muestra.

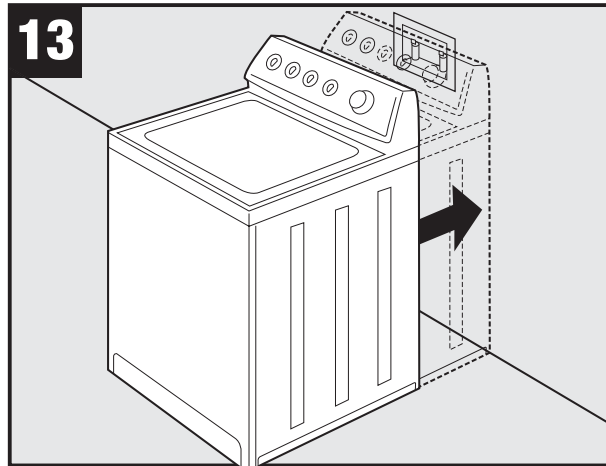

Slide washer into final position./Poussez la laveuse à son emplacement définitif./Deslice la lavadora a su lugar definitivo.

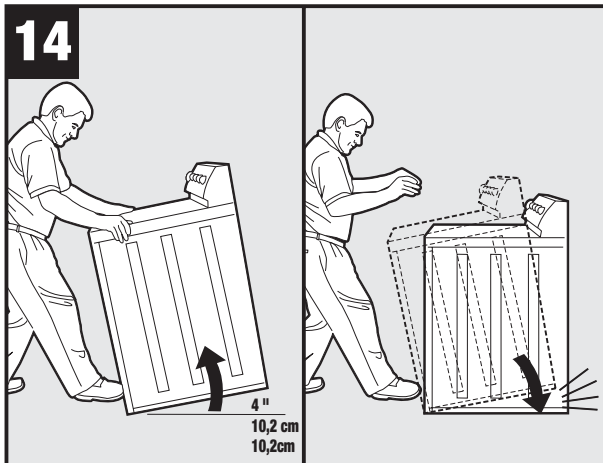

Tilt washer forward and release gently./Penchez la laveuse en avant et reposez-la doucement./Incline la lavadora hacia adelante y suéltela delicadamente.

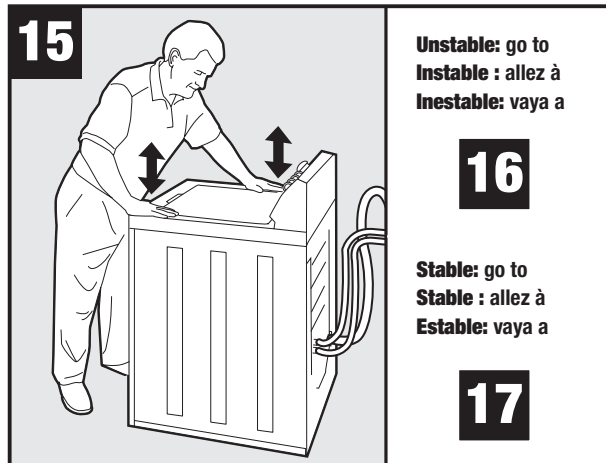

Unstable: go to
Instable : allez à
Inestable: vaya a

16

Stable: go to
Stable : allez à
Estable: vaya a

17

Place hand on opposite corners to check for stability./Mettez les mains aux angles opposés pour vérifier la stabilité./Coloque la mano en las esquinas opuestas para verificar la estabilidad.

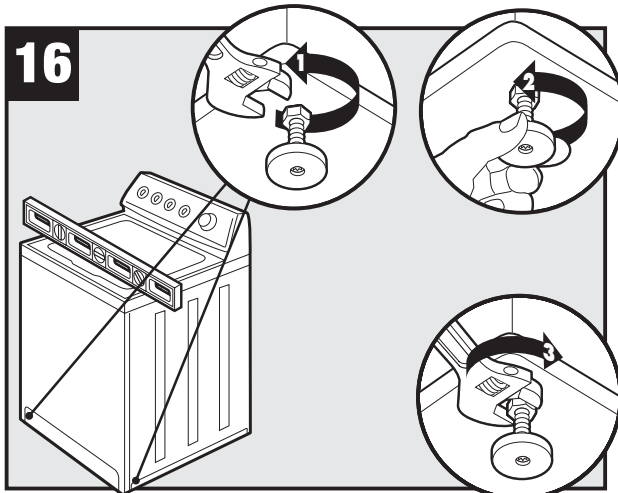

Loosen nuts on front feet, unscrew legs until washer is level side-to-side and front-to-back. Then lock the nut to base./Desserrez les écrous des pieds avant, dévissez les pieds jusqu'à ce que la laveuse soit de niveau, d'un côté à l'autre et de l'avant à l'arrière. Puis, resserrez les écrous contre la base./Ouvrez les robinets./Afloje las tuercas de las patas delanteras y destornille las patas hasta que la lavadora esté nivelada de lado a lado y de frente hacia atrás. Después cierre la tuerca contra la base.

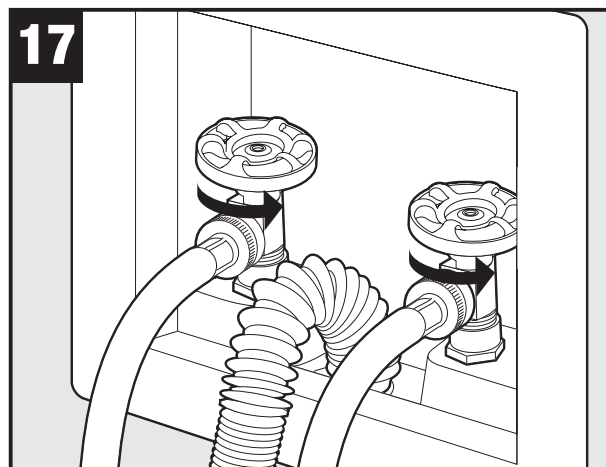

Turn on faucets./Ouvrez les robinets./Abra las llaves del agua.

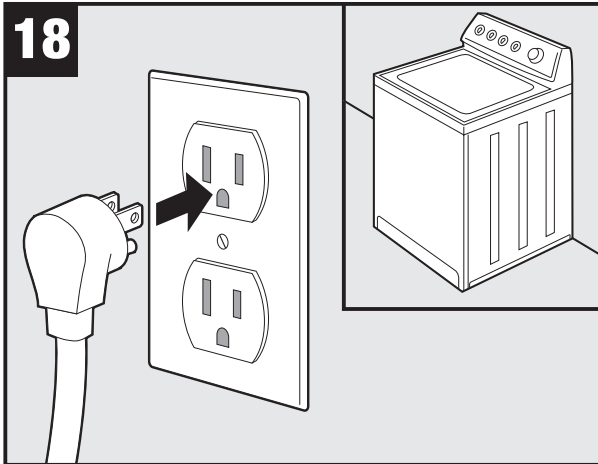
18

3-Pronged grounded outlet; 120V 60Hz, 15 or 20 amp rating required./Une prise 120 V, 60 Hz, 15 ou 20 A à 3 alvéoles, mise à la terre, est nécessaire./Se requiere un tomacorriente de 120 V 60 Hz, 15 o 20 Amp. de 3 alvéolos, puesto a tierra.

How to prepare a washer for freezing conditions/Comment préparer une laveuse à des conditions de gel./Preparación de una lavadora para condiciones de congelación.

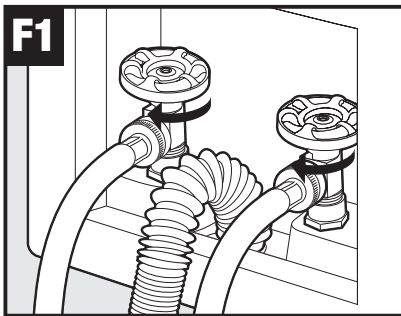

Turn off faucets./Fermez les robinets./Cierre las llaves del agua.

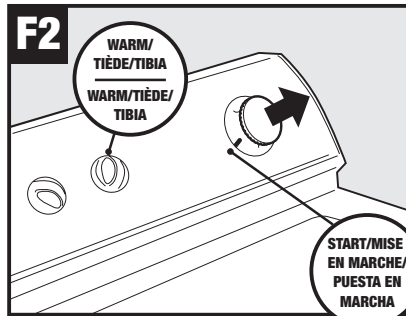

Place water temperature setting on warm/warm and pull knob to start./Réglez la température de l'eau sur tiède/tiède et tirez le bouton de mise en marche./ Coloque la temperatura del agua en tibia/tibia y tire de la perilla para ponerla en marcha.

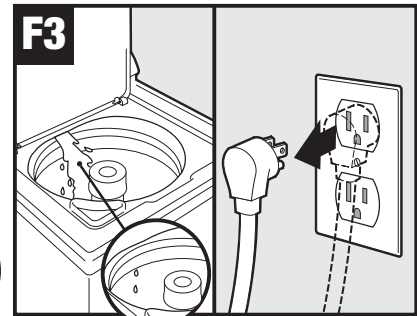

When water stops flowing, turn off unit and unplug from outlet./Quand l'eau s'arrête de couler, mettez la laveuse à l'arrêt et débranchez-la./ Cuando el agua deje de correr, apague la lavadora y desenchúfela.

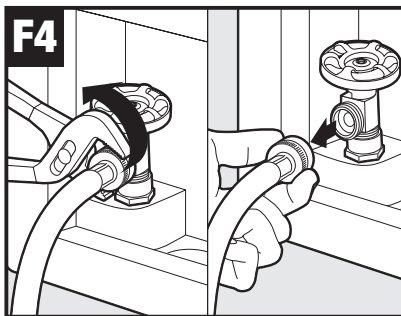

Disconnect inlet hoses from faucets./Déconnectez les tuyaux d'arrivée au niveau des robinets./ Desconecte las mangueras de admisión del agua de las llaves.

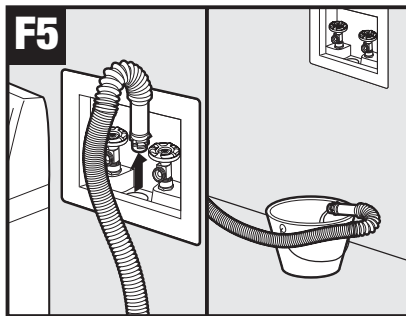

Remove drain hose and drain excess water into bucket./Enlevez le tuyau d'évacuation et faites couler l'eau restante dans un seau./ Retire la manguera de desagüe y vierta el exceso de agua en un balde.

Automatic Washing Machine Tips/Conseils pour laveuse automatique/ Consejos para la lavadora automática.

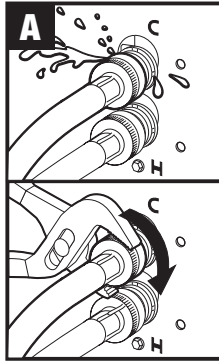

If inlet hoses leak water, tighten connection./Si les tuyaux d'arrivée d'eau fuient, resserrez les connexions./Si las mangueras de admisión escurren agua, apriete las conexiones.

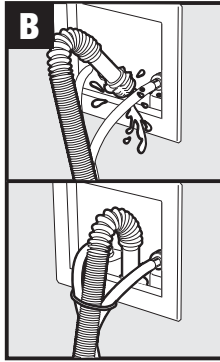

If drain hose falls out of standpipe, secure hose with tie strap as shown in step 12./Si le tuyau d'évacuation sort du tuyau vertical, fixez-le avec une attache, comme il est indiqué à l'étape 12./Si la manguera de desagüe se sale del tubo vertical, asegure la manguera con una atadura como se muestra en el paso 12.

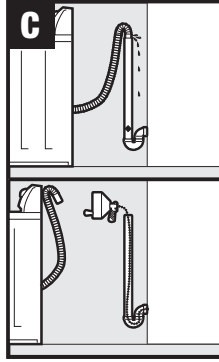

If water overflows standpipe, check pipe for obstruction and clear if possible./Si l'eau déborde du tuyau vertical, vérifiez s'il n'y a pas d'obstructions et sinon, enlevez-les./Si el agua se desborda por el tubo vertical, verifique que no hayan obstrucciones y retirelas si es posible.

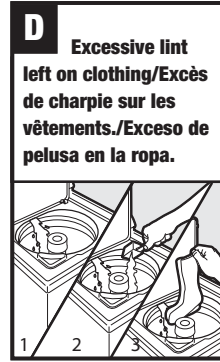

D Excessive lint left on clothing/Excès de charpie sur les vêtements./Exceso de pelusa en la ropa.

Sort clothing. 1. Start water. 2. Add detergent. 3. Add clothing./Triez les vêtements. 1. Ouvrez l'eau. 2. Ajoutez du détergent. 3. Ajoutez les vêtements./Separe la ropa. 1. Abra la llave del agua. 2. Agregue el detergente. 3. Agregue la ropa.

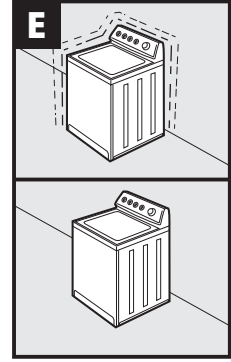

If washer is vibrating excessively, refer to step 16 in installation instructions./Si la laveuse vibre trop, reportez-vous à l'étape 16 des instructions d'installation./Si la lavadora vibra demasiado, consulte el paso 16 de las instrucciones de instalación.



F Gurgling/Gargouillis/Gorgoteo
Gurgling sound from standpipe is normal during agitation./Un gargouillis provenant du tuyau vertical est normal pendant l'agitation./Es normal que haya un sonido de gorgoteo proveniente del tubo vertical durante la agitación.

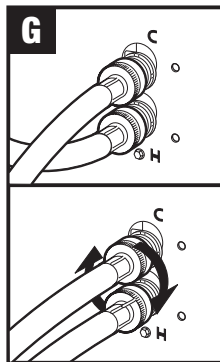

If wash water temperatures are reversed, check for proper placement of hoses./Si les températures de l'eau sont inversées, vérifiez si les tuyaux sont correctement installés./Si las temperaturas del agua de lavado están invertidas, verifique que las mangueras estén correctamente instaladas.

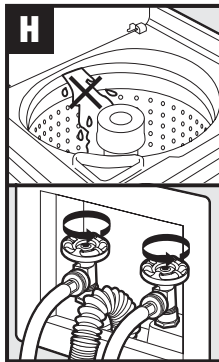

If machine does not fill with water, verify that the faucets are turned on./Si la laveuse ne se remplit pas d'eau, vérifiez que les robinets sont ouverts./Si la lavadora no se llena con agua, verifique que las llaves del agua estén abiertas.

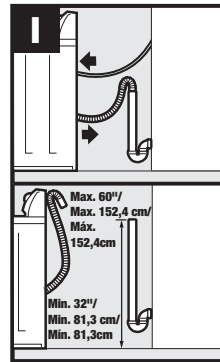

If machine is filling and draining at the same time, check for proper height of standpipe./Si la laveuse se remplit d'eau et se vide en même temps, vérifiez que le tuyau vertical est de la bonne hauteur./Si la lavadora se llena y desagua al mismo tiempo, verifique que la altura del tubo vertical sea la correcta.

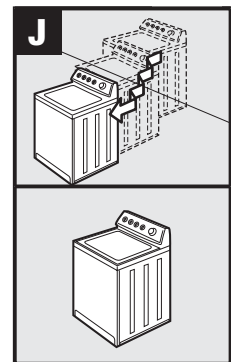

If washer is walking, see step 16 in installation instruction to verify stability./Si la laveuse se déplace, voyez l'étape 16 des instructions d'installation pour vérifier sa stabilité./Si la lavadora se desplaza, vea el paso 16 de las instrucciones de instalación para verificar su estabilidad.



Empty pockets of all loose items to avoid the possibility of an object being lodged in the pump./Videz les poches de tout article pour éviter qu'un objet se loge dans la pompe./Vacie los bolsillos de todos los artículos para evitar la posibilidad de que un objeto quede atrapado en la bomba.

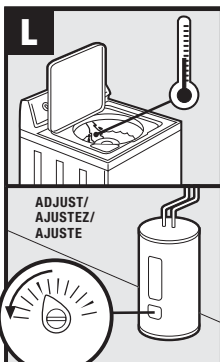

If water temperature is too hot or too cold, check setting on water heater./Si la température est trop élevée ou trop basse, vérifiez le réglage du chauffe-eau./Si la temperatura del agua es demasiado caliente o demasiado fría, verifique el ajuste en el calentador del agua.

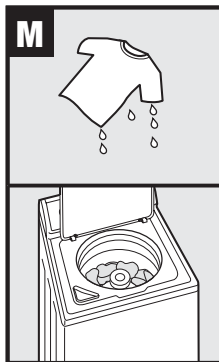

If clothing comes out too wet, properly balance the load./Si les vêtements sortent trop mouillés, équilibrez correctement la charge./Si las ropas salen demasiado mojadas, distribuya correctamente la carga de ropa.

Appendix B

The Use and Care information provided in this service manual is representative of a limited number of models. Reference the customer's Use and Care literature included with the product, order a copy, or consult the manufacturer's website for the specific model (www.maytag.com).

NOTES

Amana®

NAV-1

Washer

Use & Care Guide

Table of Contents



Important Safety Instructions 1-2



Operating Tips 3-4



Using the Controls

2 Speed Combo Models 5-6

3 Speed Combo Models 7-8

Electronic Control Models 9-11



Special Features 12-13



Care & Cleaning 13



Troubleshooting 14



Form No. A/06/05

Part No. 2204617

www.amana.com

Litho U.S.A.

©2005 Maytag Appliances Sales Co.



Important Safety Instructions

Installer: Please leave this guide with this appliance.

Consumer: Please read and keep this guide for future reference. Keep sales receipt and/or canceled check as proof of purchase.

Model Number _____

Serial Number _____

Date of Purchase _____

If you have questions, call:

Customer Assistance

1-800-688-9900 U.S.A.

1-800-688-2002 Canada

(Mon.-Fri., 8am-8pm Eastern Time)

Internet: <http://www.amana.com>

U.S. Customers using TTY for deaf, hearing impaired or speech impaired, call 1-800-688-2080.

In our continuing effort to improve the quality and performance of our appliances, it may be necessary to make changes to the appliance without revising this guide.

For service information, see page 15.

What You Need to Know About Safety Instructions

Warning and Important Safety Instructions appearing in this guide are not meant to cover all possible conditions and situations that may occur. Common sense, caution and care must be exercised when installing, maintaining or operating appliance.

Always contact the manufacturer about problems or conditions you do not understand.

Recognize Safety Symbols, Words, Labels

WARNING

WARNING – Hazards or unsafe practices which **COULD** result in severe personal injury or death.

CAUTION

CAUTION – Hazards or unsafe practices which **COULD** result in minor personal injury.

WARNING! FIRE HAZARD

Do not add gasoline, dry-cleaning solvents, or other flammable or explosive substances to the wash water. These substances give off vapors that could ignite or explode.

Do not wash articles which have been previously cleaned, washed, soaked, or spotted with gasoline, dry-cleaning solvents, oil, waxes, chemical solvents, alcohol, turpentine, or other flammable or explosive materials. These substances will be retained in articles, and articles which still contain these flammable or explosive substances give off vapors that could ignite or explode.

Observe these precautions when using cleaning fluids, spot or stain removers, etc. These products should be labeled “nonflammable.” Use according to manufacturers directions in a well ventilated area or outdoors. Thoroughly rinse articles by hand before placing them in the washer. Some of these products – rust removers for example – will damage components and the finish of the washer.

Keep area around and underneath washer free from the accumulation of combustible materials, such as lint, paper, rags, gasoline, and all other flammable vapors and liquids.

HYDROGEN GAS IS EXPLOSIVE! Under certain conditions, hydrogen gas may be produced in a hot water system that has not been used for two weeks or more. If the hot water system has not been used for such a period, before using the washer, turn on all the hot water faucets and let the water flow from each faucet for several minutes. This will release any accumulated hydrogen gas. As this gas is flammable, do not smoke or use an open flame during this time.

Recent studies have shown that if vegetable oil contaminated materials are incompletely washed, a carry-over and buildup of the oil may contribute to a chemical reaction (spontaneous combustion) that could cause a load to catch fire by itself. This would be more likely to happen if the load were left in the dryer after tumbling stopped or if items were folded and stacked while warm.



Important Safety Instructions

⚠ WARNING

To reduce the risk of fire, explosion, electric shock, or personal injury when using your washer, follow basic safety precautions, including the following:

1. Read all instructions before using the appliance.
2. As with any equipment using electricity and having moving parts, there are potential hazards. To use this appliance safely, the operator should become familiar with the instructions for operation of the appliance and always exercise care when using it.
3. **Do not** install or store this appliance where it will be exposed to the weather.
4. Install and level washer on a floor that can support the weight.
5. This appliance must be properly grounded. Never plug the appliance cord into a receptacle which is not grounded adequately and in accordance with local and national codes. See installation instructions for grounding this appliance.
6. To avoid the possibility of fire or explosion:
 - a. **Do not** wash items that have been previously cleaned in, washed in, soaked in, or spotted with gasoline, dry-cleaning solvents, other flammable or explosive substances as they give off vapors that could ignite or explode. Hand wash and line dry any items containing these substances.

Any material on which you have used a cleaning solvent, or which is saturated with flammable liquids or solids, should not be placed in the washer until all traces of these liquids or solids and their fumes have been removed.

These items include acetone, denatured alcohol, gasoline, kerosene, some liquid household cleaners, some spot removers, turpentine, waxes and wax removers.
 - b. **Do not** add gasoline, dry-cleaning solvents, or other flammable or explosive substances to the wash water. These substances give off vapors that could ignite or explode.
 - c. Under certain conditions, hydrogen gas may be produced in a hot water system that has not been used for two weeks or more. **HYDROGEN GAS IS EXPLOSIVE.** If the hot water system has not been used for such a period, before using a washing machine or combination washer-dryer, turn on all hot water faucets and let the water flow from each for several minutes. This will release any accumulated hydrogen gas. As the gas is flammable, do not smoke or use an open flame during this time.
- d. **Do not** wash or dry items that are soiled with vegetable or cooking oil. These items may contain some oil after laundering. Due to the remaining oil, the fabric may smoke or catch fire by itself.
7. **Do not** reach into the appliance if the tub or agitator is moving.
8. **Do not** allow children or pets to play on, in, or in front of the appliance. Close supervision is necessary when the appliance is used near children and pets.
9. **Do not** tamper with controls.
10. **Do not** repair or replace any part of the appliance or attempt any servicing unless specifically recommended in published user-repair instructions that you understand and have the skills to carry out.
11. Unplug power supply cord before attempting to service your washer. Service is to be done only by qualified service personnel.
12. The agitator should not be removed. If the agitator is removed, it must be replaced by pushing down completely and the locking screw tightened before the washer is operated.
13. Keep all laundry aids such as detergents, bleach, etc., out of the reach of children, preferably in a locked cabinet. Use laundry aids only as directed by the manufacturer. Observe all warnings on container labels.
14. Keep the area around and underneath washer free from the accumulation of combustible materials, such as lint, paper, rags, gasoline, and all other flammable vapors and liquids.
15. **Do not** use chlorine bleach and ammonia or acids (such as vinegar or rust remover) in the same wash. Hazardous fumes can form.
16. **Do not** machine wash fiberglass materials. Small particles can stick to fabrics washed in following loads and cause skin irritation.
17. For flame resistant finishes - follow garment manufacturer's instructions carefully. Improper laundering could remove the finish.
18. Before the appliance is removed from service or discarded, remove the door to the washing compartment.
19. Inlet hoses are subject to damage and deterioration over time. Check the hoses periodically for bulges, kinks, cuts, wear or leaks and replace them every five years.

SAVE THESE INSTRUCTIONS



Operating Tips

Detergent

- Use either liquid or granular laundry detergent. **For best results, be sure detergent is added to the washer BEFORE the load and be sure the wash water is above 60° F.**
- Use the correct amount of detergent for the load size, soil level and water conditions. Use more detergent if you have hard water and very soiled loads.
If you have soft water or a lightly soiled load, use less detergent. (See manufacturer's instructions.)
- Wipe up any detergent spills on the washer.

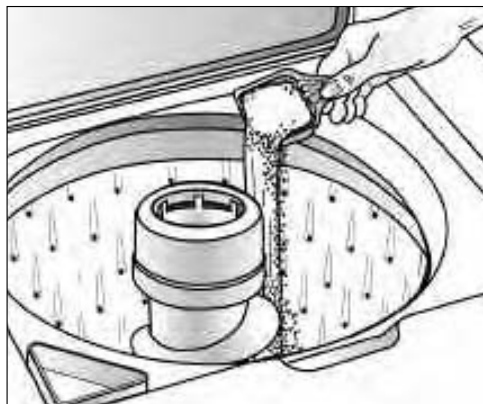

Loading

- For best results add the detergent to the washtub before adding the load.
- Put dry, unfolded clothes loosely in the tub, up to the top row of holes for a maximum load.
- **Do not** wrap large items like sheets around the agitator.
- Mix large and small items for best circulation. Wash bulky items like blankets separately.
- When laundering wrinkle free items or items of delicate construction, washable woolens or loosely knit items, never use less than the MEDIUM water level setting. This will minimize shrinkage, wrinkling and pulling of seams.
- Close lid carefully to avoid slamming.





Operating Tips

Additional Tips

- During the spin, it is possible for the load to become unevenly distributed in the tub. If this happens, push **in** the control dial, open the lid, redistribute the load, close the lid and restart the washer. The spin will resume at the point it was interrupted.
- The washer will pause briefly throughout each cycle. These pauses are normal.
- This washer is designed so that it will not agitate or spin when the lid is open. It will, however, fill with the lid open so water is available for pretreating stains or diluting fabric softener.
- If you open the lid during a spin cycle, the washer will stop. When the lid is closed and the washer is restarted, the washer will continue the cycle at the point it was interrupted.



Using the Controls – 2 Speed Combo Models

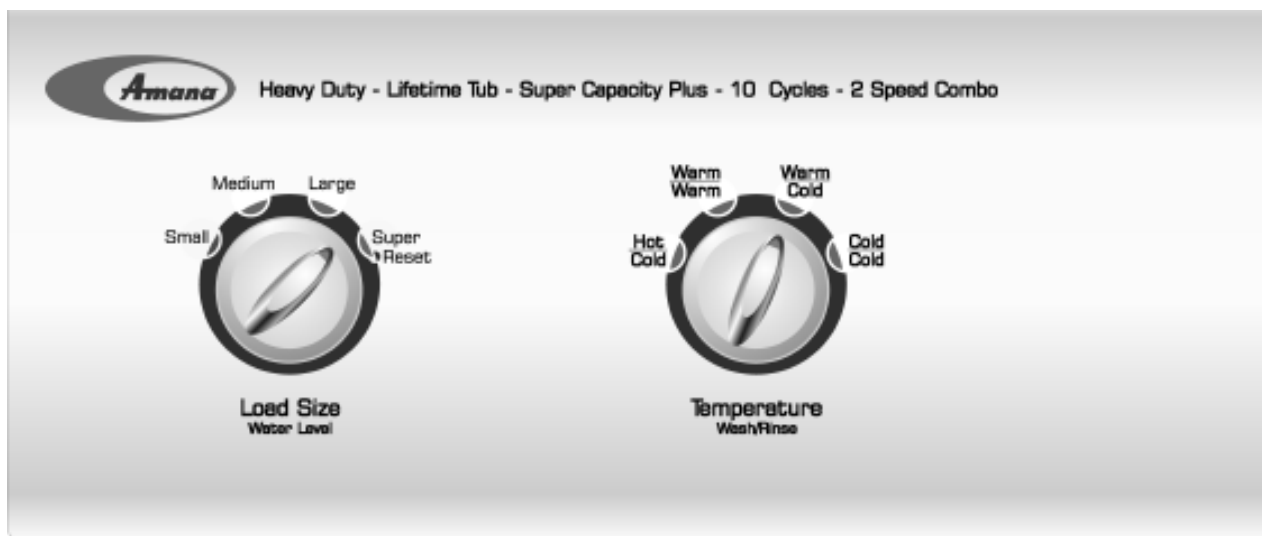

STEP 1

Select Water Level

Determine the selected setting based on clothes load size. Selection should provide sufficient water to permit clothes to circulate freely during agitation.

It may become necessary, due to bulky fabrics, to adjust the water level after agitation begins. To adjust the water level, turn the control to **reset** and then back to the desired setting.

WATER LEVEL SETTING	LOAD SIZE
Small	1/4 - 1/3
Medium	1/3 - 1/2
Large	1/2 - 2/3
Super	2/3 - Full

Note: Items must circulate freely for best results.

STEP 2

Select Wash/Rinse Temperature

Your washer gives you a choice of hot, warm or cold water for washing and cold or warm water (select models) for rinsing. Use the chart below as a guide.

WASH/RINSE TEMPS	LOAD TYPE
Hot/Cold	White and heavily soiled, color-fast items.
Warm/Warm	Moderately soiled, colored items.
Warm/Cold	Moderately soiled, colored items; most permanent press items.
Cold/Cold	Brightly colored, lightly soiled items; washable woolens.

Note: In wash water temperatures below 60° F, detergents do not dissolve well or clean well. Care labels define cold water as up to 85° F.

Control features vary by model.

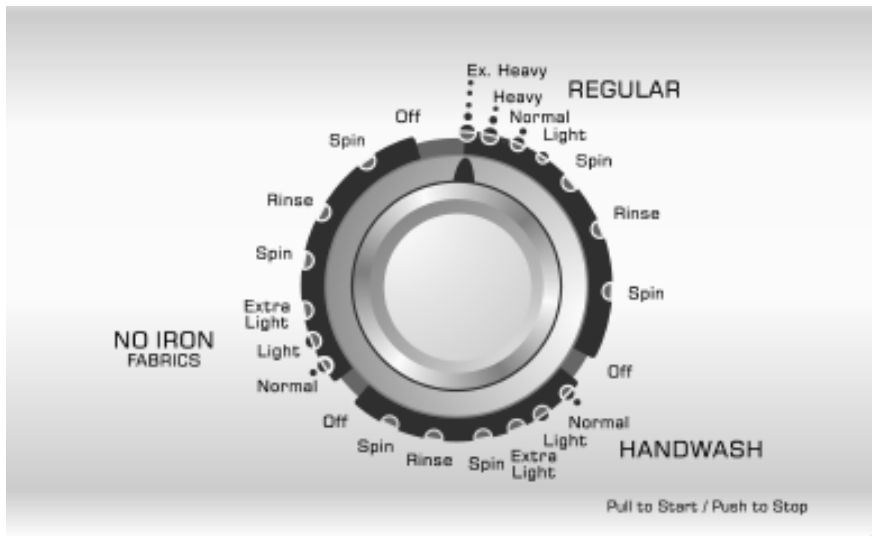

STEP 3

Select Cycle

To select a cycle, push the control dial **in** (off position) and turn it to the *right* (clockwise) until the pointer is at the soil level needed for the wash load in the Regular, Handwash or No Iron Fabrics cycles.

Regular Cycle

Provides normal agitation and normal spin speeds to wash cottons and heavily soiled items. For maximum cleaning, set the dial at **Extra Heavy**.

No Iron Fabrics Cycle

Provides normal agitation and normal spin speeds with a spray rinse to reduce wrinkling.

Handwash Cycle

Provides intermittent agitation and soak for delicates and knits.

STEP 4

Pull Control Dial Out to Start

You may stop the washer at any time by simply pushing the control dial **in**. Therefore it is possible to obtain a non-agitated soak or to shorten, skip or repeat any part of a cycle. The control dial must be pushed **in** (off position) when you change the setting.

Note: Do not attempt to turn the control dial counterclockwise. Damage to the timer will result.



Using the Controls – 3 Speed Combo Models

STEP 1

Select Water Level

Determine the selected setting based on clothes load size. Selection should provide sufficient water to permit clothes to circulate freely during agitation.

It may become necessary, due to bulky fabrics, to adjust the water level after agitation begins. To adjust the water level, turn the control to **reset** and then back to the desired setting.

WATER LEVEL SETTING	LOAD SIZE
Mini	1/4 Full
Small	1/4 - 1/3
Medium	1/3 - 1/2
Large	1/2 - 2/3
Super	2/3 - Full

Note: Items must circulate freely for best results.

STEP 2

Select Wash/Rinse Temperature

Your washer gives you a choice of hot or cold water for washing and cold or warm water (select models) for rinsing.

WASH/RINSE TEMPS	LOAD TYPE
Hot/Cold	White and heavily soiled, color-fast items.
Warm/Warm	Moderately soiled, colored items.
Warm/Cold	Moderately soiled, colored items; most permanent press items.
Cold/Cold	Brightly colored, lightly soiled items; washable woolsens.

Note: In wash water temperatures below 60° F, detergents do not dissolve well or clean well. Care labels define cold water as up to 85° F.

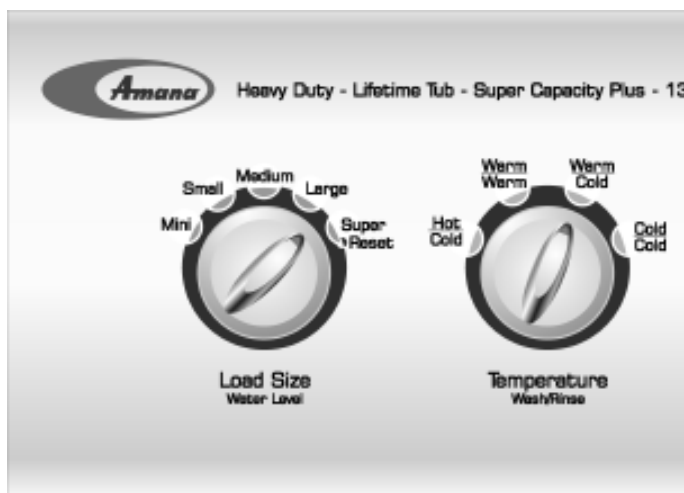

STEP 3

Select Cycle

To select a cycle, push the control dial **in** (off position) and turn it to the **right** (clockwise) until the pointer is at the soil level needed for the wash load in the Regular, Handwash, No Iron Fabrics or Quick Wash cycles.

Regular Cycle

Provides normal agitation and normal spin speeds to wash cottons and heavily soiled items. For maximum cleaning, set the dial at **Heavy**.

No Iron Fabrics Cycle

Provides normal agitation and normal spin speeds with a spray rinse to reduce wrinkling.

Handwash Cycle

Provides intermittent agitation and soak for delicates and knits.

Quick Wash Cycle

Provides normal agitation and normal spin speeds. Use to quickly clean small, lightly soiled loads or to refresh items.

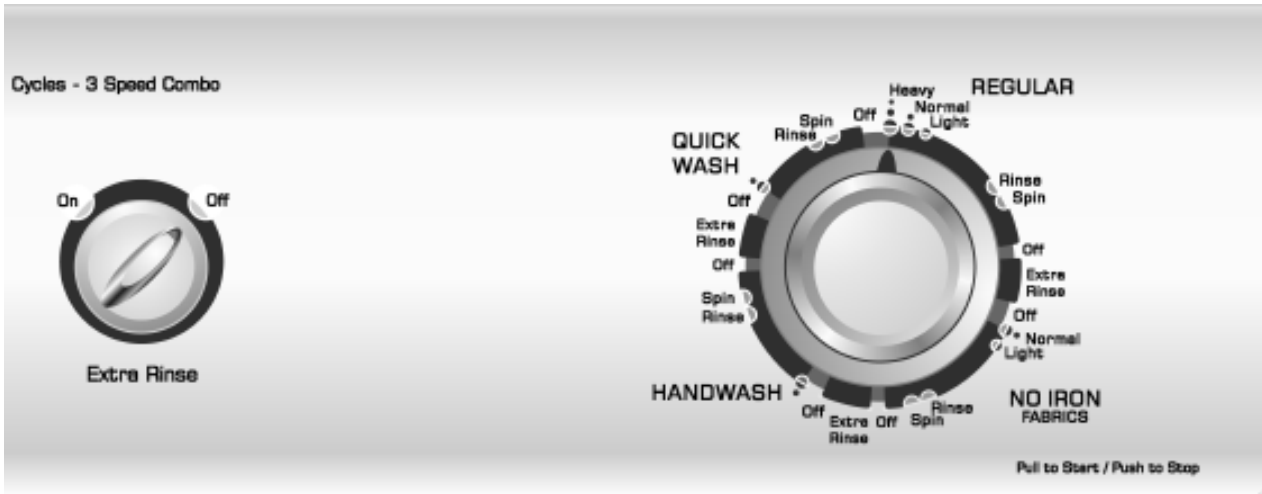

STEP 4

Select Options (if desired)

Extra Rinse

When the switch or knob is in the **On** position, an additional rinse at the end of the Regular, No Iron Fabrics and Handwash cycles is provided to more completely remove laundry additives, suds, perfumes, etc.

STEP 5

Pull Control Dial Out to Start

You may stop the washer at any time by simply pushing the control dial **in**. Therefore it is possible to obtain a non-agitated soak or to shorten, skip or repeat any part of a cycle. The control dial must be pushed **in** (off position) when you change the setting.

Note: Do not attempt to turn the control dial counterclockwise. Damage to the timer will result.



Using the Controls – Electronic Control Models

Getting Started

1. Add detergent and additives to the washer.
2. Load the washer.
3. Close the lid.
4. Select the appropriate cycle and options for the load.
5. Press the **Cycle Selector** dial.
6. The Fill indicator light will illuminate and the washer will start to fill.

Note: The lid must be completely closed in order to operate the washer controls.

STEP 1

Select Water Level

Determine the selected setting based on clothes load size. Selection should provide sufficient water to permit clothes to circulate freely during agitation.

It may become necessary, due to bulky fabrics, to adjust the water level after agitation begins. To adjust the water level, turn the Infinite Water Level control to **reset** and then back to the desired setting.

WATER LEVEL SETTING	LOAD SIZE
Small	1/4 - 1/3
Medium	1/3 - 1/2
Large	1/2 - 2/3
Super	2/3 - Full

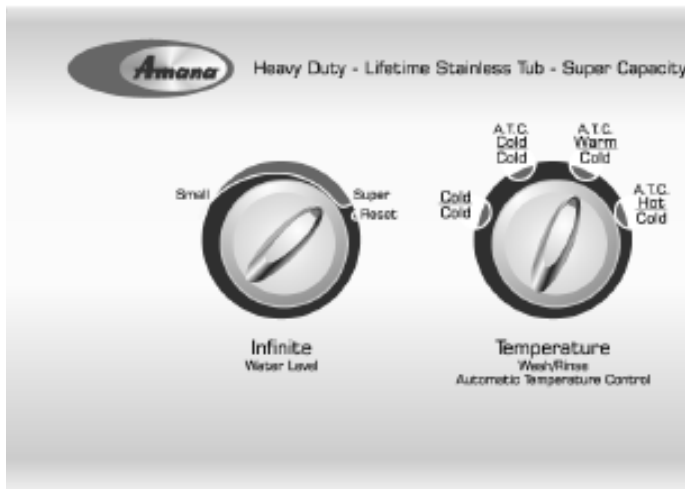

STEP 2

Select Wash/Rinse Temperature

Your washer gives you a choice of hot, warm or cold water for washing and cold water or warm water (select models) for rinsing. Use the chart below as a guide.

Automatic Temperature Control (A.T.C.) provides the optimal wash water temperature for cleaning. To save energy, this washer will regulate wash water temperatures by mixing hot and cold water to reach the proper water temperature.

WASH/RINSE TEMPS	LOAD TYPE
Cold/Cold (select models)	Brightly colored, lightly soiled items; washable woolens.
These settings feature Automatic Temperature Control:	
ATC Hot/Cold, ATC Warm/Cold	Saves energy by adding cold water to the hot water from your water heater. Provides optimum cleaning at lower temperatures.
ATC Cold/Cold	May add hot water to the incoming cold water as the washer fills. This assures that the water will be warm enough to properly activate detergent.

Control features vary by model.

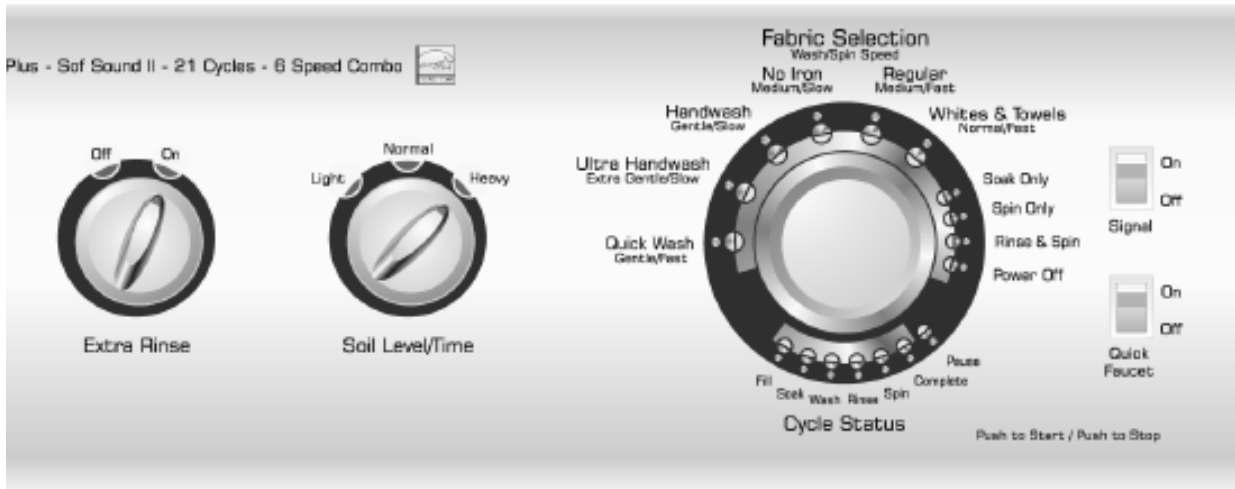

STEP 3

Select Options

Extra Rinse

When the knob is in the **On** position, an additional rinse at the end of all cycles is provided to more completely remove laundry additives, suds, perfumes, etc.

End of Cycle Signal

The End of Cycle Signal will sound once the cycle is completed. On select models, the End of Cycle Signal can be canceled by setting the switch to **Off**.

STEP 4

Soil Level/Time Selection

Your washer has selectable soil level/time settings.

SOIL SELECTION	LOAD TYPE
Light	Use for cleaning lightly soiled loads.
Normal	Use for cleaning moderately soiled loads. This setting will be appropriate for most loads.
Heavy	Use for cleaning heavily soiled loads.



Using the Controls – Electronic Control Models

STEP 5

Fabric Selection

Select the appropriate fabric cycle for the type of load by turning the cycle selector dial until the indicator light by the desired fabric selection is illuminated.

WASH/SPIN SPEED	FABRIC SELECTION
Quick Wash Gentle/Fast	For lightly soiled or wrinkled garments needed quickly.
Ultra Hand Wash Ex. Gentle/Slow	Provides intermittent agitation and soak. For wool, silk, and other hand-wash-only fabrics.
Hand wash Gentle/Slow	For sheer fabrics, bras and lingerie needing slower spin speed because of clothing construction.
No Iron Medium/Slow	For “wash and wear” and synthetic fabrics and lightly to normally soiled garments needing a slower spin speed to reduce wrinkling.
Regular Medium/Fast	For most sturdy fabrics including cottons, linens and normally soiled garments needing maximum water extraction.
Whites & Towels Normal/Fast	For sturdy fabrics and heavily soiled whites needing maximum water extraction.

Soak Only

Provides approximately 33 minutes of alternating periods of soaking with brief agitation at slow speed. At the end of the cycle, the Cycle Selector dial must be manually set to a wash cycle or spin cycle to drain the washer. Avoid extended soaking.

Spin Only

Provides a spin to remove more water from the load.

Rinse and Spin

Use for loads that need rinsing only or to add rinse-added fabric softener to a load.

Power Off

To cancel the cycle and turn off the washer, turn the Cycle Selector dial to **Power Off** and push the dial **in**.

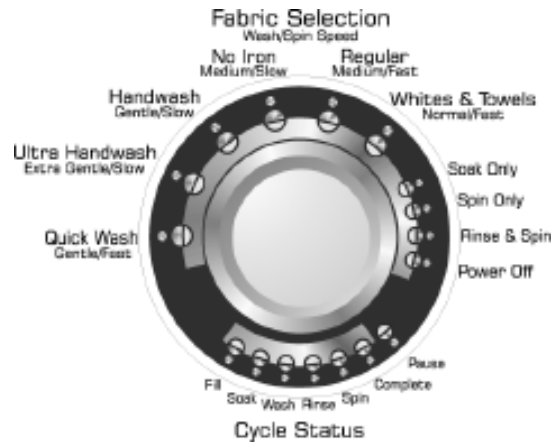

STEP 6

Start the Washer

To start the washer, press the **cycle selector** dial.

Changing a Cycle

If an incorrect cycle has been accidentally selected:

1. Press the **cycle selector** dial.
2. Turn the **cycle selector** dial to the desired cycle.
3. Set the desired options for the cycle.
4. Press the **cycle selector** dial. The Wash indicator lights stop flashing and the new cycle starts.

Canceling a Cycle

To cancel a cycle:

1. Press the **cycle selector** dial.
2. Turn the cycle selector dial to **Power Off** and push the dial **in**.

To drain the washer:

1. Select the **Rinse & Spin** or **Spin Only** cycle.
2. Press the **cycle selector** dial. The Spin light illuminates and the washer starts the rinse or spin.

Special Features

Liquid Bleach Dispenser

The dispenser automatically dilutes liquid chlorine bleach before it reaches your wash load. To use, follow these steps:

1. Measure liquid chlorine bleach carefully, following the instructions on the bottle.
2. **Pour liquid chlorine bleach into the bleach dispenser** before adding the load. Avoid splashing or over-filling the dispenser.



Pour liquid chlorine bleach into bleach dispenser.

Notes:

- Never pour undiluted liquid chlorine bleach directly onto the load or into the wash tub. It is a powerful chemical and can cause fabric damage, such as tearing or color loss, if not used properly.
- If you prefer to use color-safe, non-chlorine bleach, pour it into the wash tub with your detergent. **Do not** pour non-chlorine bleaches into the bleach dispenser.

Quick Faucet (select models)

Provides a flow of water when holding the switch in the **On** position.



Fabric Softener Dispenser

The dispenser automatically releases liquid fabric softener at the proper time during the cycle.

To use, follow these steps:

1. Pour a measured amount of fabric softener into the dispenser to fill line only.
2. If fabric softener comes below line, add warm water.

If it is necessary to clean the dispenser:

1. Pull the dispenser off of the top of the agitator.
2. Soak for one hour in sink or container in hot water and dishwashing liquid.
3. Hold hands over top and bottom of dispenser and shake to loosen buildup.
4. Rinse with clean, hot water.
5. Repeat process if necessary.
6. Replace dispenser on agitator.

Do not use dishwashing liquid inside the washer. Oversudsing can occur.



Automatic Lint Filtering System

The Lint Filtering System does not require cleaning.

Wash and rinse water is filtered and re-filtered continuously to trap lint shed by most fabrics during the agitation cycle before it can be redeposited on the wash load. The engineered hole design on the wash basket in conjunction with water flow produced by the agitator, traps lint away from the clothes between the inner wash basket and the outer tub. Lint is automatically flushed from the washer during the spin cycle.

Safety Spin

If for any reason you open the washer lid when the washer is in a spin or extract period, the operation will immediately stop. This is for your personal safety. If your washer does not stop, call your service technician immediately. When the lid is closed, the operation will automatically resume.



Special Features

Unbalanced Spin Load Compensator

Your new washer is designed to handle out-of-balance loads without shutting down or interrupting the washing cycle.

For this reason, the cycle will always be completed. If heavier fabrics in such out-of-balance loads should ever contain excessive moisture at the completion of the cycle, redistribute the clothes in the washer and reset the control dial for the final spin period.



Care & Cleaning

1. After washing, leave the lid open until the interior is dry.
2. Check hoses to be sure there are no kinks or knots.
3. Your washer should not be installed where temperatures will go below freezing, as damage to the washer could result.
4. To clean, occasionally wipe exterior with a clean damp sponge or cloth. **Do not** use polish on plastic parts.
5. Lifetime lubrication is done at the factory, so your washer never needs to be oiled or greased.
6. **Do not** lay heavy or sharp objects on top of your washer.
7. The top of the washer should not be used for removing stains from garments. Some stain removers, such as rust remover, will mar the finish.
8. Remove pins, buckles or other sharp objects from clothes to prevent scratching interior parts.
9. Clothes should not be stored in washer.
10. Bleach, detergent, solvents, etc. spilled on the top of your washer that are allowed to remain will remove the glossy finish. Remove all spills with a damp, soft cloth.
11. If you close your home for the winter, have a service technician drain the washer. Unplug cord from electrical outlet and disconnect hoses from faucets.

Overload Protector

A built-in protector automatically shuts off the washer motor in case of an overload. This can occur if:

- The load being washed is too heavy.
- Too many appliances are plugged into the line operating your washer.
- A low voltage condition exists on the line.
- Lid is opened and closed repeatedly.

The overload protector permits the washer to start again when the motor has cooled to a safe operating temperature. If the motor stops repeatedly, call your service technician.

Cleaning the Interior

Clean the interior of the washer periodically to remove any dirt, soil, odor, mold, mildew or bacteria residue that may remain in the washer as a result of washing clothes. We recommend taking the following steps every 60 to 120 days to clean and freshen your washer interior. The frequency with which the washer should be cleaned and freshened depends on factors such as usage, the amount of dirt, soil or bacteria being run through your washer, or the use of cold water. Failure to follow these instructions may result in unsatisfactory conditions, including unpleasant odor and/or permanent stains on the washer or washload.

To clean and freshen the washer interior:

1. Add a measured amount of chlorine bleach to the bleach dispenser, following package directions.
2. Add 1/4 cup of detergent to the tub.
3. Run the washer without a load through a complete cycle using hot water.
4. Repeat the process if necessary.



Troubleshooting

Won't Fill	<ul style="list-style-type: none"> • Plug cord into live electrical outlet. • Check fuse or reset circuit breaker. • Turn the control dial to proper cycle and restart the washer. • Turn both faucets on fully. • Straighten inlet hoses. • Disconnect hoses and clean screens. Hose filter screens may be plugged.
Won't Agitate	<ul style="list-style-type: none"> • Check fuse or reset circuit breaker. • Make sure the lid is completely closed. • Turn the control dial to proper cycle and restart the washer. • Pauses are normal. Wait and see if the washer will start again.
Won't Spin or Drain	<ul style="list-style-type: none"> • Check fuse or reset circuit breaker. • Straighten drain hoses. Eliminate kinked hoses. If there is a home drain restriction, call for drain service. • Close lid and restart the washer. For your safety, washer will not spin unless the lid is closed. • Suds lock – caused by too much suds. Rewash without detergent. Use correct amount of a low-sudsing detergent.
Load is Wet	<ul style="list-style-type: none"> • Unevenly distributed load. Redistribute the load, close the lid and restart the washer. Check for leveling. Be sure water level is acceptable for load size. • A normal spin speed is recommended for heavy loads like jeans or towels.
Stops	<ul style="list-style-type: none"> • Plug cord into live electrical outlet. • Check fuse or reset circuit breaker. • Close lid and restart the washer. For your safety, washer will not agitate or spin unless lid is closed. • This may be a pause in the cycle. Wait briefly and it may start.
Leaks Water	<ul style="list-style-type: none"> • Make sure hose connections are tight. • Make sure end of drain hose is correctly inserted and secured to drain facility. • Avoid extended soaking – soak for 30 minutes or less. • Avoid overloading.
Is Noisy	<ul style="list-style-type: none"> • Be sure washer is leveled properly as outlined in installation manual. • Weak floors can cause vibration and walking. • Operating sounds will vary depending on agitation speed.
Fills with the Wrong Temperature Water	<ul style="list-style-type: none"> • Turn both faucets on fully. • If equipped with a temperature selector knob, be sure it is set directly on a temperature setting and not between settings. • Make sure temperature selection is correct. • While the washer is filling, you may notice just hot and/or just cold water entering the tub when cold or warm wash temperatures are selected. This is a normal function of the Automatic Temperature Control (select models) feature as the washer determines the temperature of the water. • If Auto Temperature Control (select models) is selected, cold water may feel warmer than cold water from the tap. • Make sure hoses are connected to correct faucets and inlet connections. Be sure water supply is regulated correctly. Flush water line before filling washer. • Check the water heater. It should be set to deliver a minimum 120° F (49° C) hot water at the tap. Also check water heater capacity and recovery rate. • Disconnect hoses and clean screens. Hose filter screens may be plugged.
Cycle Selector Advances Through Off	<ul style="list-style-type: none"> • Extra Rinse (select models) is selected.

For further assistance, call Maytag Customer Assistance toll-free at 1-800-688-9900 USA or 1-800-688-2002 Canada. U.S. customers using TTY for deaf, hearing impaired or speech impaired, call 1-800-688-2080.

NOTES



MAV-1

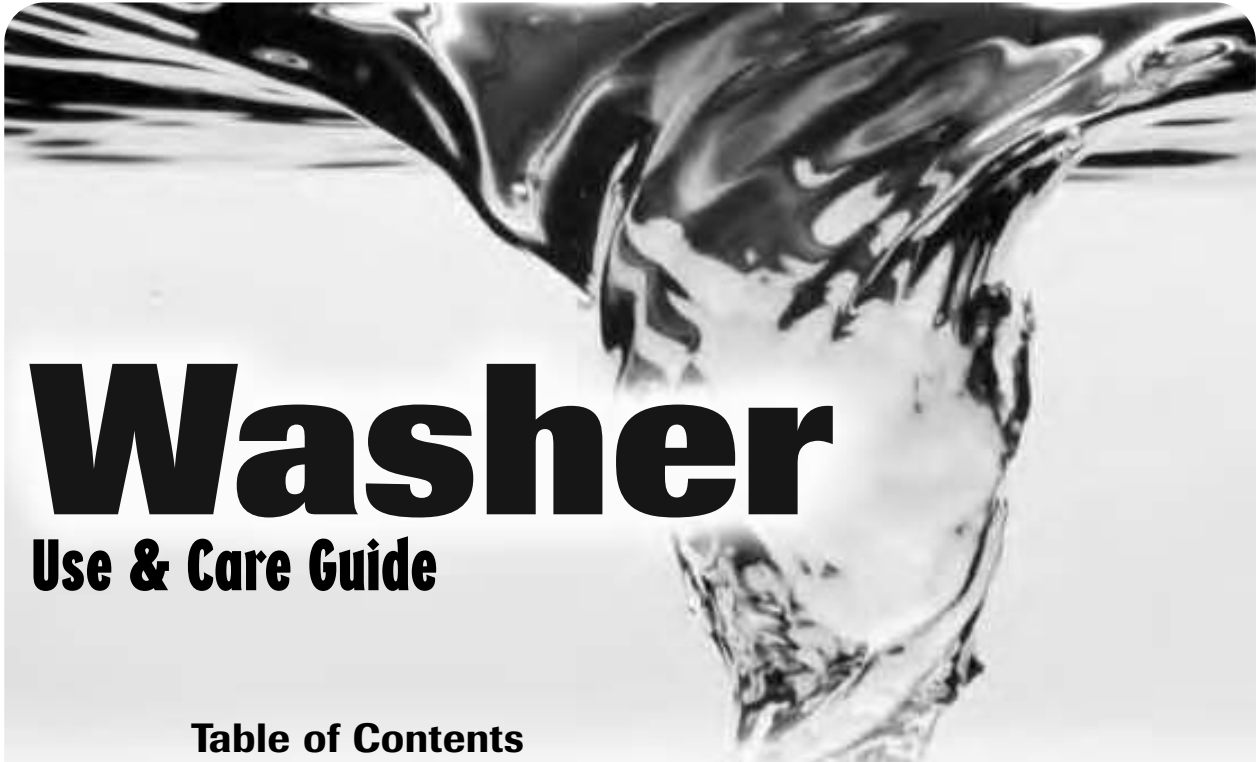

Washer

Use & Care Guide

Table of Contents



Important Safety Instructions 1-2



Operating Tips 3-4



Using the Controls
3 Speed Select Models 5-6
4 Speed Select Models 7-8
Electronic Control Models 9-11



Special Features 12-13



Care & Cleaning 13



Troubleshooting 14





Important Safety Instructions

Installer: Please leave this guide with this appliance.

Consumer: Please read and keep this guide for future reference. Keep sales receipt and/or canceled check as proof of purchase.

Model Number _____

Serial Number _____

Date of Purchase _____

If you have questions, call:

Customer Assistance

1-800-688-9900 U.S.A.

1-800-688-2002 Canada

(Mon.-Fri., 8am-8pm Eastern Time)

Internet: <http://www.amana.com>

U.S. Customers using TTY for deaf, hearing impaired or speech impaired, call 1-800-688-2080.

In our continuing effort to improve the quality and performance of our appliances, it may be necessary to make changes to the appliance without revising this guide.

For service information, see page 15.

What You Need to Know About Safety Instructions

Warning and Important Safety Instructions appearing in this guide are not meant to cover all possible conditions and situations that may occur. Common sense, caution and care must be exercised when installing, maintaining or operating appliance.

Always contact the manufacturer about problems or conditions you do not understand.

Recognize Safety Symbols, Words, Labels

WARNING

WARNING – Hazards or unsafe practices which **COULD** result in severe personal injury or death.

CAUTION

CAUTION – Hazards or unsafe practices which **COULD** result in minor personal injury.

WARNING! FIRE HAZARD

Do not add gasoline, dry-cleaning solvents, or other flammable or explosive substances to the wash water. These substances give off vapors that could ignite or explode.

Do not wash articles which have been previously cleaned, washed, soaked, or spotted with gasoline, dry-cleaning solvents, oil, waxes, chemical solvents, alcohol, turpentine, or other flammable or explosive materials. These substances will be retained in articles, and articles which still contain these flammable or explosive substances give off vapors that could ignite or explode.

Observe these precautions when using cleaning fluids, spot or stain removers, etc. These products should be labeled “nonflammable.” Use according to manufacturers directions in a well ventilated area or outdoors. Thoroughly rinse articles by hand before placing them in the washer. Some of these products – rust removers for example – will damage components and the finish of the washer.

Keep area around and underneath washer free from the accumulation of combustible materials, such as lint, paper, rags, gasoline, and all other flammable vapors and liquids.

HYDROGEN GAS IS EXPLOSIVE! Under certain conditions, hydrogen gas may be produced in a hot water system that has not been used for two weeks or more. If the hot water system has not been used for such a period, before using the washer, turn on all the hot water faucets and let the water flow from each faucet for several minutes. This will release any accumulated hydrogen gas. As this gas is flammable, do not smoke or use an open flame during this time.

Recent studies have shown that if vegetable oil contaminated materials are incompletely washed, a carry-over and buildup of the oil may contribute to a chemical reaction (spontaneous combustion) that could cause a load to catch fire by itself. This would be more likely to happen if the load were left in the dryer after tumbling stopped or if items were folded and stacked while warm.



Important Safety Instructions

⚠ WARNING

To reduce the risk of fire, explosion, electric shock, or personal injury when using your washer, follow basic safety precautions, including the following:

1. Read all instructions before using the appliance.
2. As with any equipment using electricity and having moving parts, there are potential hazards. To use this appliance safely, the operator should become familiar with the instructions for operation of the appliance and always exercise care when using it.
3. **Do not** install or store this appliance where it will be exposed to the weather.
4. Install and level washer on a floor that can support the weight.
5. This appliance must be properly grounded. Never plug the appliance cord into a receptacle which is not grounded adequately and in accordance with local and national codes. See installation instructions for grounding this appliance.
6. To avoid the possibility of fire or explosion:
 - a. **Do not** wash items that have been previously cleaned in, washed in, soaked in, or spotted with gasoline, dry-cleaning solvents, other flammable or explosive substances as they give off vapors that could ignite or explode. Hand wash and line dry any items containing these substances.

Any material on which you have used a cleaning solvent, or which is saturated with flammable liquids or solids, should not be placed in the washer until all traces of these liquids or solids and their fumes have been removed.

These items include acetone, denatured alcohol, gasoline, kerosene, some liquid household cleaners, some spot removers, turpentine, waxes and wax removers.
 - b. **Do not** add gasoline, dry-cleaning solvents, or other flammable or explosive substances to the wash water. These substances give off vapors that could ignite or explode.
 - c. Under certain conditions, hydrogen gas may be produced in a hot water system that has not been used for two weeks or more. **HYDROGEN GAS IS EXPLOSIVE.** If the hot water system has not been used for such a period, before using a washing machine or combination washer-dryer, turn on all hot water faucets and let the water flow from each for several minutes. This will release any accumulated hydrogen gas. As the gas is flammable, do not smoke or use an open flame during this time.
- d. **Do not** wash or dry items that are soiled with vegetable or cooking oil. These items may contain some oil after laundering. Due to the remaining oil, the fabric may smoke or catch fire by itself.
7. **Do not** reach into the appliance if the tub or agitator is moving.
8. **Do not** allow children or pets to play on, in, or in front of the appliance. Close supervision is necessary when the appliance is used near children and pets.
9. **Do not** tamper with controls.
10. **Do not** repair or replace any part of the appliance or attempt any servicing unless specifically recommended in published user-repair instructions that you understand and have the skills to carry out.
11. Unplug power supply cord before attempting to service your washer. Service is to be done only by qualified service personnel.
12. The agitator should not be removed. If the agitator is removed, it must be replaced by pushing down completely and the locking screw tightened before the washer is operated.
13. Keep all laundry aids such as detergents, bleach, etc., out of the reach of children, preferably in a locked cabinet. Use laundry aids only as directed by the manufacturer. Observe all warnings on container labels.
14. Keep the area around and underneath washer free from the accumulation of combustible materials, such as lint, paper, rags, gasoline, and all other flammable vapors and liquids.
15. **Do not** use chlorine bleach and ammonia or acids (such as vinegar or rust remover) in the same wash. Hazardous fumes can form.
16. **Do not** machine wash fiberglass materials. Small particles can stick to fabrics washed in following loads and cause skin irritation.
17. For flame resistant finishes - follow garment manufacturer's instructions carefully. Improper laundering could remove the finish.
18. Before the appliance is removed from service or discarded, remove the door to the washing compartment.
19. Inlet hoses are subject to damage and deterioration over time. Check the hoses periodically for bulges, kinks, cuts, wear or leaks and replace them every five years.

SAVE THESE INSTRUCTIONS



Operating Tips

Detergent

- Use either liquid or granular laundry detergent. **For best results, be sure detergent is added to the washer BEFORE the load and be sure the wash water is above 60° F.**
- Use the correct amount of detergent for the load size, soil level and water conditions. Use more detergent if you have hard water and very soiled loads.
If you have soft water or a lightly soiled load, use less detergent. (See manufacturer's instructions.)
- Wipe up any detergent spills on the washer.

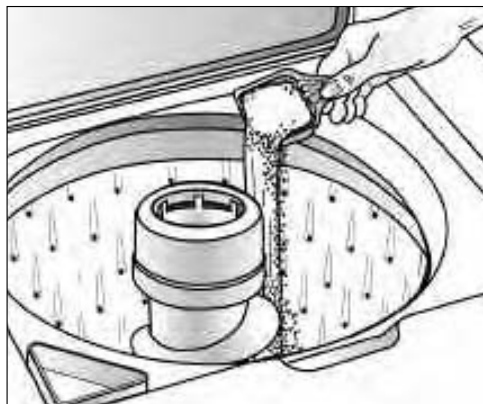

Loading

- For best results add the detergent to the washtub before adding the load.
- Put dry, unfolded clothes loosely in the tub, up to the top row of holes for a maximum load.
- **Do not** wrap large items like sheets around the agitator.
- Mix large and small items for best circulation. Wash bulky items like blankets separately.
- When laundering wrinkle free items or items of delicate construction, washable woolens or loosely knit items, never use less than the MEDIUM water level setting. This will minimize shrinkage, wrinkling and pulling of seams.
- Close lid carefully to avoid slamming.





Operating Tips

Additional Tips

- During the spin, it is possible for the load to become unevenly distributed in the tub. If this happens, push **in** the control dial, open the lid, redistribute the load, close the lid and restart the washer. The spin will resume at the point it was interrupted.
- The washer will pause briefly throughout each cycle. These pauses are normal.
- This washer is designed so that it will not agitate or spin when the lid is open. It will, however, fill with the lid open so water is available for pretreating stains or diluting fabric softener.
- If you open the lid during a spin cycle, the washer will stop. When the lid is closed and the washer is restarted, the washer will continue the cycle at the point it was interrupted.



Using the Controls – 3 Speed Select Models

STEP 1

Select Water Level

Determine the selected setting based on clothes load size. Selection should provide sufficient water to permit clothes to circulate freely during agitation.

It may become necessary, due to bulky fabrics, to adjust the water level after agitation begins. To adjust the water level, turn the control to **reset** and then back to the desired setting.

WATER LEVEL SETTING	LOAD SIZE
Mini	1/4 Full
Small	1/4 - 1/3
Medium	1/3 - 1/2
Large	1/2 - 2/3
Super	3/4 - Full

Note: Items must circulate freely for best results.

STEP 2

Select Wash/Rinse Temperature

Your washer gives you a choice of hot, warm or cold water for washing and cold or warm water (select models) for rinsing. Use the chart below as a guide.

WASH/RINSE TEMPS	LOAD TYPE
Hot/Cold	White and heavily soiled, color-fast items.
Warm/Warm (select models)	Moderately soiled, colored items.
Warm/Cold	Moderately soiled, colored items; most wrinkle-free items.
Cold/Cold	Brightly colored, lightly soiled items; washable woolens.

Note: In wash water temperatures below 60° F, detergents **do not** dissolve well or clean well. Care labels define cold water as up to 85° F.

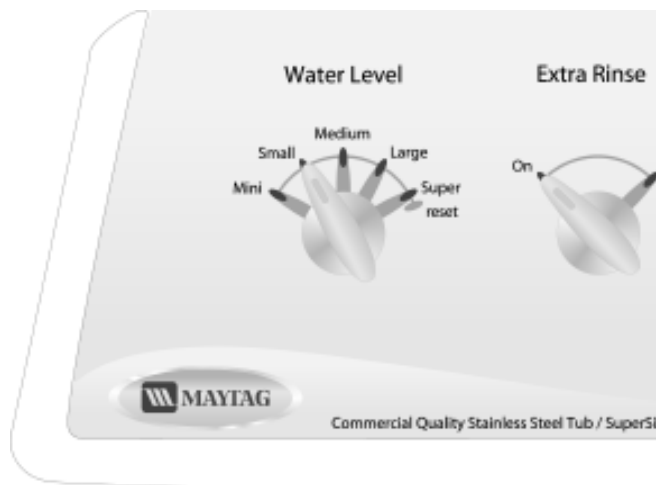

Automatic Temperature Control (A.T.C.) (select models) provides the optimal wash water temperatures for cleaning. To save energy, the Automatic Temperature Control will regulate wash water temperatures by mixing hot and cold water to reach the proper water temperature.

WASH/RINSE TEMPS	LOAD TYPE
These settings feature Automatic Temperature Control:	
ATC Hot/Cold, ATC Warm/Cold ATC Warm/Warm (select models)	Saves energy by adding cold water to the hot water from your water heater. Provides optimum cleaning at lower temperatures.
ATC Cold/Cold	May add hot water to the incoming cold water as the washer fills. This assures that the water will be warm enough to properly activate detergent.

Control features vary by model.

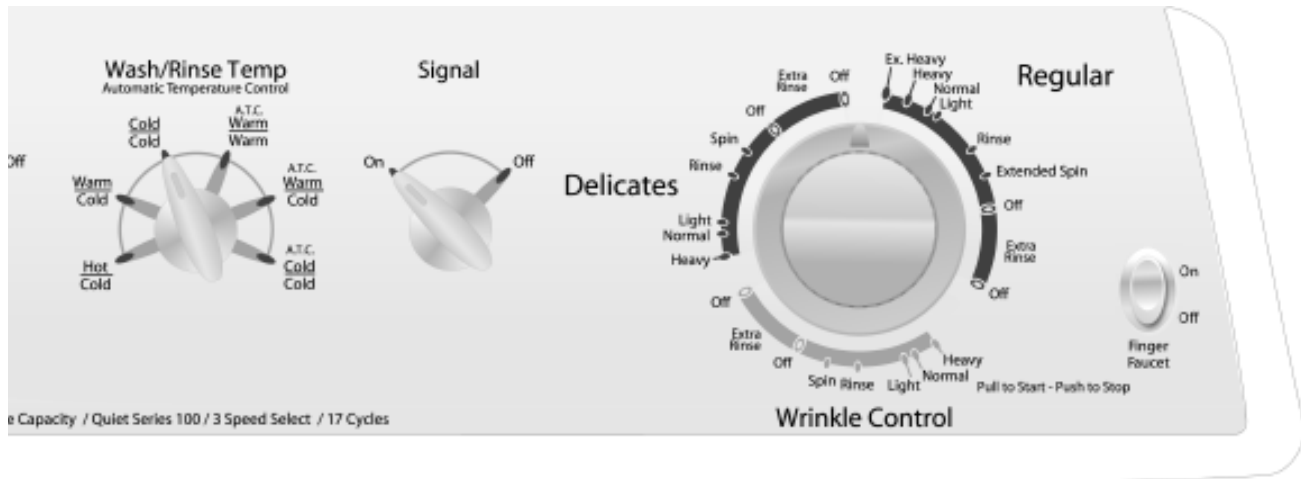

STEP 3

Select Cycle

To select a cycle, push the control dial **in** (off position) and turn it to the *right* (clockwise) until the pointer is at the soil level needed for the wash load in the Regular, Wrinkle Control or Delicates cycles.

Regular Cycle

Provides normal agitation and normal spin speeds to wash cottons and heavily soiled items. For maximum cleaning, set the dial at **Extra Heavy**.

Wrinkle Control Cycle

Provides normal agitation and slow spin speed to protect wrinkle control fabrics.

Delicates Cycle

Provides slow agitation speed and slow spin speed for delicates and knits.

STEP 4

Select Options (if desired)

Extra Rinse

When the switch is in the **On** position, an additional rinse at the end of the Regular, Wrinkle Control and Delicates cycles is provided to more completely remove laundry additives, suds, perfumes, etc.

End of Cycle Signal (select models)

The End of Cycle Signal will sound once the cycle is completed. The End of Cycle Signal can be canceled by setting the switch to **Off**.

STEP 5

Pull Control Dial Out to Start

You may stop the washer at any time by simply pushing the control dial **in**. Therefore, it is possible to obtain a non-agitated soak or to shorten, skip or repeat any part of a cycle. The control dial must be pushed **in** (off position) when you change the setting.

Note: Do not attempt to turn the control dial counterclockwise. Damage to the timer will result.



Using the Controls – 4 Speed Select Models

STEP 1

Select Water Level

Determine the selected setting based on clothes load size. Selection should provide sufficient water to permit clothes to circulate freely during agitation. On select models, the Infinite Water Level control allows you to select a specific setting or anywhere in between.

It may become necessary, due to bulky fabrics, to adjust the water level after agitation begins. To adjust the water level, turn the control to **reset** and then back to the desired setting.

WATER LEVEL SETTING	LOAD SIZE
Mini	1/4 Full
Small	1/4 - 1/3
Medium	1/3 - 1/2
Large	1/2 - 2/3
Super	3/4 - Full

Note: Items must circulate freely for best results.

STEP 2

Select Wash/Rinse Temperature

Your washer gives you a choice of hot, warm or cold water for washing and cold or warm water (select models) for rinsing.

WASH/RINSE TEMPS	LOAD TYPE
Hot/Cold	White and heavily soiled, color-fast items.
Warm/Warm (select models)	Moderately soiled, colored items.
Warm/Cold	Moderately soiled, colored items; most wrinkle-free items.
Cold/Cold	Brightly colored, lightly soiled items; washable woolens.

Automatic Temperature Control (A.T.C.) (select models) provides the optimal wash water temperature for cleaning. To save energy, this washer will regulate wash water temperatures by mixing hot and cold water to reach the proper water temperature.

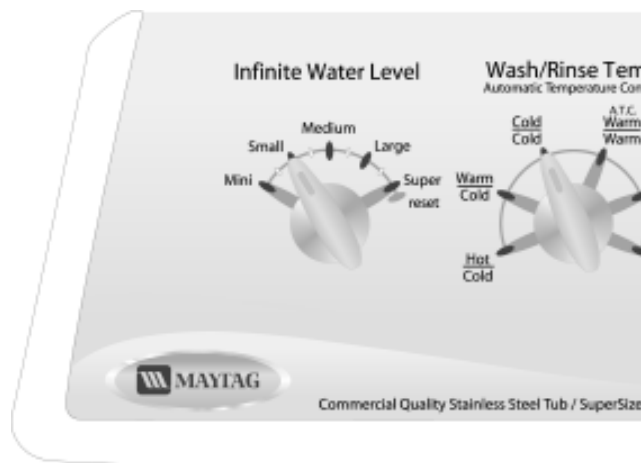

WASH/RINSE TEMPS	LOAD TYPE
These settings feature Automatic Temperature Control:	
ATC Hot/Cold, ATC Warm/Cold, ATC Warm/Warm	Saves energy by adding cold water to the hot water from your water heater. Provides optimum cleaning at lower temperatures.
ATC Cold/Cold	May add hot water to the incoming cold water as the washer fills. This assures that the water will be warm enough to properly activate detergent.

STEP 3

Select Wash/Spin Speed

Your washer has selectable wash and spin speed combinations.

WASH/SPIN SPEED	LOAD TYPE
Regular Normal/Fast	Sturdy fabrics needing maximum water extraction like jeans, towels and bedding
Wrinkle Control Normal/Slow	Sturdy fabrics needing a slower spin speed to reduce wrinkling, such as dress shirts and dress pants
Delicate Gentle/Slow	Delicate fabrics needing slower spin speed because of clothing construction
Handwash Ex. Gentle/Slow	Intermittent slow agitation and soak to gently wash the most delicate items

Note: In wash water temperatures below 60° F, detergents **do not** dissolve well or clean well.

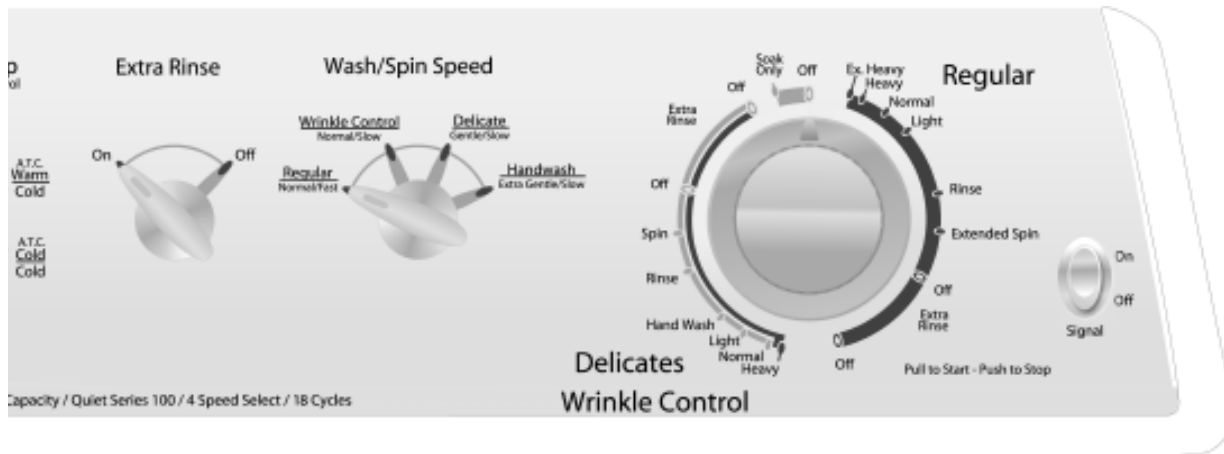

STEP 4

Select Cycle

To select a cycle, push the control dial **in** (off position) and turn it to the *right* (clockwise) until the pointer is at the soil level needed for the wash load.

Important: For optimum fabric care, the appropriate wash and spin speed for the load type must be selected using the wash/spin speed knob.

Regular Cycle

This cycle provides up to 16 minutes of agitation. Select the **Regular Wash/Spin Speed** setting.

Wrinkle Control

This cycle is designed for sturdy fabrics needing a slower spin speed to reduce wrinkling, such as dress shirts and dress pants. Select the **Wrinkle Control Wash/Spin Speed** setting.

Delicates Cycle

Delicates is designed for items requiring delicate wash action. Select the **Delicates Wash/Spin Speed** setting.

When washing delicate fabrics labeled hand wash, select the **Handwash Wash/Spin Speed** setting. This setting provides intermittent slow agitation and soak with a slow spin.

Soak Only (select models)

Provides 4 minutes of agitation, then soak. **Avoid extended soaking – soak for 30 minutes or less.** *The control dial must be manually advanced to a spin setting to spin and drain the water.*

STEP 5

Select Options (if desired)

Extra Rinse

When the knob is in the **On** position, an additional rinse at the end of the Regular, Wrinkle Control and Delicates cycles is provided to more completely remove laundry additives, suds, perfumes, etc.

End of Cycle Signal (select models)

The end of cycle signal will sound once the cycle is completed. The end of cycle signal can be canceled by setting the switch to **Off**.

STEP 6

Pull Control Dial Out to Start

You may stop the washer at any time by simply pushing the control dial **in**. Therefore it is possible to obtain a non-agitated soak or to shorten, skip or repeat any part of a cycle. The control dial must be pushed **in** (off position) when you change the setting.

Note: Do not attempt to turn the control dial counterclockwise. Damage to the timer will result.



Using the Controls – Electronic Control Models

Getting Started

1. Add detergent and additives to the washer.
2. Load the washer.
3. Close the lid.
4. Select the appropriate cycle and options for the load.
5. Press the **Cycle Selector** dial.
6. The Fill indicator light will illuminate and the washer will start to fill.

Note: The lid must be completely closed in order to operate the washer controls.

STEP 1

Select Water Level

Determine the selected setting based on clothes load size. Selection should provide sufficient water to permit clothes to circulate freely during agitation.

It may become necessary, due to bulky fabrics, to adjust the water level after agitation begins. To adjust the water level, turn the Infinite Water Level control to **reset** and then back to the desired setting.

WATER LEVEL SETTING	LOAD SIZE
Mini	1/4 Full
Small	1/4 - 1/3
Medium	1/3 - 1/2
Large	1/2 - 2/3
Super	3/4 - Full

Note: Items must circulate freely for best results.

STEP 2

Select Wash/Rinse Temperature

Your washer gives you a choice of hot, warm or cold water for washing and cold water or warm water (select models) for rinsing. Use the chart as a guide.

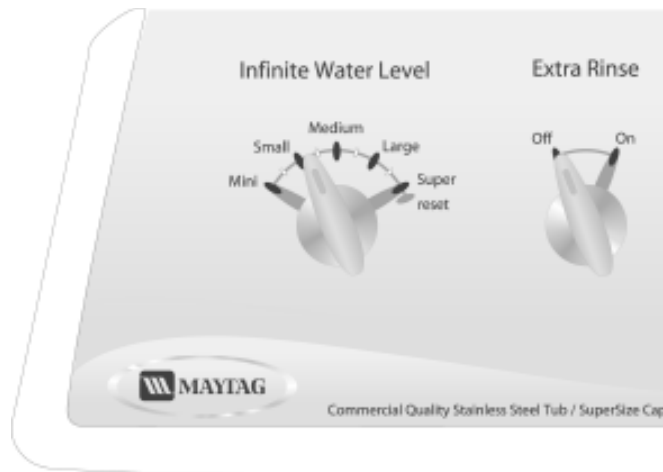

WASH/RINSE TEMPS	LOAD TYPE
Hot/Cold (select models)	White and heavily soiled, color-fast items.
Warm/Warm (select models)	Moderately soiled, colored items.
Warm/Cold (select models)	Moderately soiled, colored items; most wrinkle-free items.
Cold/Cold	Brightly colored, lightly soiled items; washable woolens.

Automatic Temperature Control (A.T.C.) provides the optimal wash water temperature for cleaning. To save energy, this washer will regulate wash water temperatures by mixing hot and cold water to reach the proper water temperature.

WASH/RINSE TEMPS	LOAD TYPE
These settings feature Automatic Temperature Control:	
ATC Hot/Cold, ATC Warm/Cold, ATC Warm/Warm (select models)	Saves energy by adding cold water to the hot water from your water heater. Provides optimum cleaning at lower temperatures.
ATC Cold/Cold	May add hot water to the incoming cold water as the washer fills. This assures that the water will be warm enough to properly activate detergent.

Control features vary by model.

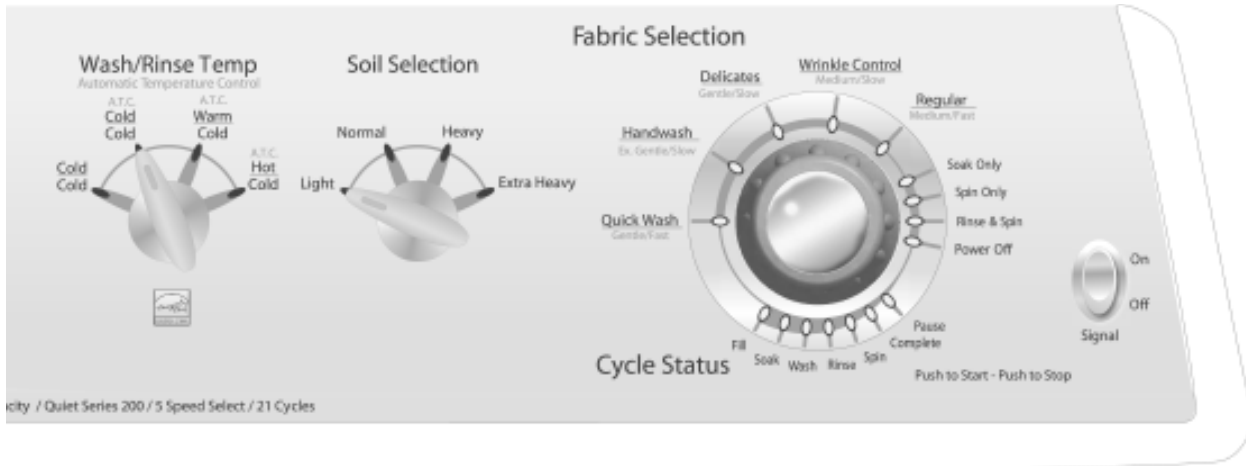

STEP 3

Soil Selection

Your washer has selectable soil level settings.

SOIL SELECTION	LOAD TYPE
Light	Use for cleaning lightly soiled loads.
Normal	Use for cleaning moderately soiled loads. This setting will be appropriate for most loads.
Heavy	Use for cleaning heavily soiled loads.
Extra Heavy	Use for cleaning stained, heavily soiled sturdy loads.

STEP 4

Fabric Selection

Select the appropriate fabric cycle for the type of load by turning the cycle selector dial until the indicator light by the desired fabric selection is illuminated.

WASH/SPIN SPEED	FABRIC SELECTION
Quick Wash Gentle/Fast	For lightly soiled or wrinkled garments needed quickly.
Hand Wash Ex. Gentle/Slow	Provides intermittent agitation and soak. For wool, silk, and other hand-wash-only fabrics.
Delicates Gentle/Slow	For sheer fabrics, bras and lingerie needing slower agitation and spin speeds because of clothing construction.
Wrinkle Control Medium/Slow	For "wash and wear" and synthetic fabrics and lightly to normally soiled garments needing a slower spin speed to reduce wrinkling.
Regular Medium/Fast	For most sturdy fabrics including cottons, linens and normally soiled garments needing maximum water extraction.



Using the Controls – Electronic Control Models

STEP 5

Soak Only (select models)

Provides approximately 33 minutes of alternating periods of soaking with brief agitation at slow speed. *At the end of the cycle, the Cycle Selector dial must be manually set to a wash cycle or spin cycle to drain the washer. Avoid extended soaking.*

Spin Only

Provides a spin to remove more water from the load.

Rinse and Spin

Use for loads that need rinsing only or to add rinse-added fabric softener to a load.

Power Off

To cancel the cycle and turn off the washer, turn the Cycle Selector dial to **Power Off** and push the dial **in**.

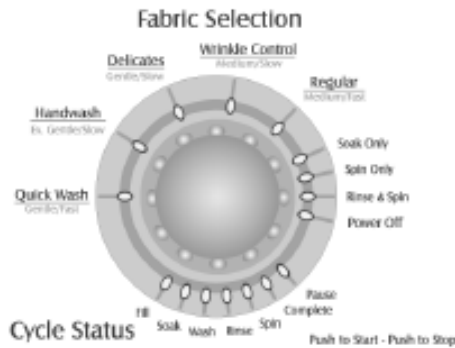

STEP 6

Select Options

Extra Rinse

When the knob is in the **On** position, an additional rinse at the end of all cycles is provided to more completely remove laundry additives, suds, perfumes, etc.

Extra Rinse



End of Cycle Signal

The end of cycle signal will sound once the cycle is completed. On select models, the end of cycle signal can be canceled by setting the switch to **Off**.

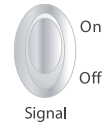

STEP 7

Start the Washer

To start the washer, press the **cycle selector** dial.

Changing a Cycle

If an incorrect cycle has been accidentally selected:

1. Press the **cycle selector** dial.
2. Turn the **cycle selector** dial to the desired cycle.
3. Set the desired options for the cycle.
4. Press the **cycle selector** dial. The Wash indicator lights stop flashing and the new cycle starts.

Canceling a Cycle

To cancel a cycle:

1. Press the **cycle selector** dial.
2. Turn the cycle selector dial to **Power Off** and push the dial **in**.

To drain the washer:

1. Select the **Rinse and Spin** or **Spin Only** cycle.
2. Press the **cycle selector** dial. The Spin light illuminates and the washer starts the rinse or spin.



Special Features

Liquid Bleach Dispenser

The dispenser automatically dilutes liquid chlorine bleach before it reaches your wash load.

To use, follow these steps:

1. Measure liquid chlorine bleach carefully, following the instructions on the bottle.
2. **Pour liquid chlorine bleach into bleach dispenser** before adding the load. Avoid splashing or over-filling the dispenser.



Notes:

- Never pour undiluted liquid chlorine bleach directly onto the load or into the wash tub. It is a powerful chemical and can cause fabric damage, such as tearing or color loss, if not used properly.
- If you prefer to use color-safe, non-chlorine bleach, pour it into the wash tub with your detergent. **Do not** pour non-chlorine bleaches into the bleach dispenser.

Finger Faucet (select models)

Provides a flow of water when holding the switch in the **On** position.



Fabric Softener Dispenser

The dispenser automatically releases liquid fabric softener at the proper time during the cycle.

To use, follow these steps:

1. Pour a measured amount of fabric softener into the dispenser to fill line only.
2. If fabric softener comes below line, add warm water.

If it is necessary to clean the dispenser:

1. Pull the dispenser off of the top of the agitator.
2. Soak for one hour in sink or container in hot water and dishwashing liquid.
3. Hold hands over top and bottom of dispenser and shake to loosen buildup.
4. Rinse with clean, hot water.
5. Repeat process if necessary.
6. Replace dispenser on agitator.



Do not use dishwashing liquid inside the washer. Oversudsing can occur.

Automatic Lint Filtering System

The Lint Filtering System does not require cleaning.

Wash and rinse water is filtered and re-filtered continuously to trap lint shed by most fabrics during the agitation cycle before it can be redeposited on the wash load. The engineered hole design on the wash basket in conjunction with water flow produced by the agitator, traps lint away from the clothes between the inner wash basket and the outer tub. Lint is automatically flushed from the washer during the spin cycle.

Safety Spin

If for any reason you open the washer lid when the washer is in a spin or extract period, the operation will immediately stop. This is for your personal safety. If your washer does not stop, call your service technician immediately. When the lid is closed, the operation will automatically resume.

Special Features

Unbalanced Spin Load Compensator

Your new washer is designed to handle out-of-balance loads without shutting down or interrupting the washing cycle.

For this reason, the cycle will always be completed. If heavier fabrics in such out-of-balance loads should ever contain excessive moisture at the completion of the cycle, redistribute the clothes in the washer and reset the control dial for the final spin period.

Care & Cleaning

1. After washing, leave the lid open until the interior is dry.
2. Check hoses to be sure there are no kinks or knots.
3. Your washer should not be installed where temperatures will go below freezing, as damage to the washer could result.
4. To clean, occasionally wipe exterior with a clean damp sponge or cloth. **Do not** use polish on plastic parts.
5. Lifetime lubrication is done at the factory, so your washer never needs to be oiled or greased.
6. **Do not** lay heavy or sharp objects on top of your washer.
7. The top of the washer should not be used for removing stains from garments. Some stain removers, such as rust remover, will mar the finish.
8. Remove pins, buckles or other sharp objects from clothes to prevent scratching interior parts.
9. Clothes should not be stored in washer.
10. Bleach, detergent, solvents, etc. spilled on the top of your washer that are allowed to remain will remove the glossy finish. Remove all spills with a damp, soft cloth.
11. If you close your home for the winter, have a service technician drain the washer. Unplug cord from electrical outlet and disconnect hoses from faucets.

Overload Protector

A built-in protector automatically shuts off the washer motor in case of an overload. This can occur if:

- The load being washed is too heavy.
- Too many appliances are plugged into the line operating your washer.
- A low voltage condition exists on the line.
- Lid is opened and closed repeatedly.

The overload protector permits the washer to start again when the motor has cooled to a safe operating temperature. If the motor stops repeatedly, call your service technician.

Cleaning the Interior

Clean the interior of the washer periodically to remove any dirt, soil, odor, mold, mildew or bacteria residue that may remain in the washer as a result of washing clothes. We recommend taking the following steps every 60 to 120 days to clean and freshen your washer interior. The frequency with which the washer should be cleaned and freshened depends on factors such as usage, the amount of dirt, soil or bacteria being run through your washer, or the use of cold water. Failure to follow these instructions may result in unsatisfactory conditions, including unpleasant odor and/or permanent stains on the washer or washload.

To clean and freshen the washer interior:

1. Add a measured amount of chlorine bleach to the bleach dispenser, following package directions.
2. Add 1/4 cup of detergent to the tub.
3. Run the washer without a load through a complete cycle using hot water.
4. Repeat the process if necessary.



Troubleshooting

Won't Fill	<ul style="list-style-type: none"> • Plug cord into live electrical outlet. • Check fuse or reset circuit breaker. • Turn the control dial to proper cycle and restart the washer. • Turn both faucets on fully. • Straighten inlet hoses. • Disconnect hoses and clean screens. Hose filter screens may be plugged.
Won't Agitate	<ul style="list-style-type: none"> • Check fuse or reset circuit breaker. • Make sure the lid is completely closed. • Turn the control dial to proper cycle and restart the washer. • Pauses are normal. Wait and see if the washer will start again.
Won't Spin or Drain	<ul style="list-style-type: none"> • Check fuse or reset circuit breaker. • Straighten drain hoses. Eliminate kinked hoses. If there is a home drain restriction, call for drain service. • Close lid and restart the washer. For your safety, washer will not spin unless the lid is closed. • Suds lock – caused by too much suds. Rewash without detergent. Use correct amount of a low-sudsing detergent.
Load is Wet	<ul style="list-style-type: none"> • Unevenly distributed load. Redistribute the load, close the lid and restart the washer. Check for leveling. Be sure water level is acceptable for load size. • A normal spin speed is recommended for heavy loads like jeans or towels.
Stops	<ul style="list-style-type: none"> • Plug cord into live electrical outlet. • Check fuse or reset circuit breaker. • Close lid and restart the washer. For your safety, washer will not agitate or spin unless lid is closed. • This may be a pause in the cycle. Wait briefly and it may start.
Leaks Water	<ul style="list-style-type: none"> • Make sure hose connections are tight. • Make sure end of drain hose is correctly inserted and secured to drain facility. • Avoid extended soaking – soak for 30 minutes or less. • Avoid overloading.
Is Noisy	<ul style="list-style-type: none"> • Be sure washer is leveled properly as outlined in installation manual. • Weak floors can cause vibration and walking. • Operating sounds will vary depending on agitation speed.
Fills with the Wrong Temperature Water	<ul style="list-style-type: none"> • Turn both faucets on fully. • If equipped with a temperature selector dial, be sure it is set directly on a temperature setting and not between settings. • Make sure temperature selection is correct. • While the washer is filling, you may notice just hot and/or just cold water entering the tub when cold or warm wash temperatures are selected. This is a normal function of the Automatic Temperature Control (select models) feature as the washer determines the temperature of the water. • If Auto Temperature Control (select models) is selected, cold water may feel warmer than cold water from the tap. • Make sure hoses are connected to correct faucets and inlet connections. Be sure water supply is regulated correctly. Flush water line before filling washer. • Check the water heater. It should be set to deliver a minimum 120° F (49° C) hot water at the tap. Also check water heater capacity and recovery rate. • Disconnect hoses and clean screens. Hose filter screens may be plugged.
Cycle Selector Advances Through Off	<ul style="list-style-type: none"> • Extra Rinse (select models) is selected.

For further assistance, call Maytag Customer Assistance toll-free at 1-800-688-9900 USA or 1-800-688-2002 Canada. U.S. customers using TTY for deaf, hearing impaired or speech impaired, call 1-800-688-2080.

NOTES

10.1 Kg

AAV-3

Washer

Use & Care Guide

Admiral



Table of Contents



Important Safety Instructions 1-2



Care & Cleaning 11



Using the Controls
2 Speed Combo Models 3-4
3 Speed Combo Models 5-6
4 Speed Combo Models 7-8



Troubleshooting 12



Operating Tips 9



Special Features 10-11



Important Safety Instructions

Installer: Please leave this guide with this appliance.

Consumer: Please read and keep this guide for future reference. Keep sales receipt and/or canceled check as proof of purchase.

Model Number _____

Serial Number _____

Date of Purchase _____

If you have questions, call:

Customer Assistance

1-800-688-9900 U.S.A.

1-800-688-2002 Canada

(Mon.-Fri., 8am-8pm Eastern Time)

Internet: <http://www.amana.com>

U.S. Customers using TTY for deaf, hearing impaired or speech impaired, call 1-800-688-2080.

In our continuing effort to improve the quality and performance of our appliances, it may be necessary to make changes to the appliance without revising this guide.

For service information, see page 15.

What You Need to Know About Safety Instructions

Warning and Important Safety Instructions appearing in this guide are not meant to cover all possible conditions and situations that may occur. Common sense, caution and care must be exercised when installing, maintaining or operating appliance.

Always contact the manufacturer about problems or conditions you do not understand.

Recognize Safety Symbols, Words, Labels

WARNING

WARNING – Hazards or unsafe practices which **COULD** result in severe personal injury or death.

CAUTION

CAUTION – Hazards or unsafe practices which **COULD** result in minor personal injury.

WARNING! FIRE HAZARD

Do not add gasoline, dry-cleaning solvents, or other flammable or explosive substances to the wash water. These substances give off vapors that could ignite or explode.

Do not wash articles which have been previously cleaned, washed, soaked, or spotted with gasoline, dry-cleaning solvents, oil, waxes, chemical solvents, alcohol, turpentine, or other flammable or explosive materials. These substances will be retained in articles, and articles which still contain these flammable or explosive substances give off vapors that could ignite or explode.

Observe these precautions when using cleaning fluids, spot or stain removers, etc. These products should be labeled “nonflammable.” Use according to manufacturers directions in a well ventilated area or outdoors. Thoroughly rinse articles by hand before placing them in the washer. Some of these products – rust removers for example – will damage components and the finish of the washer.

Keep area around and underneath washer free from the accumulation of combustible materials, such as lint, paper, rags, gasoline, and all other flammable vapors and liquids.

HYDROGEN GAS IS EXPLOSIVE! Under certain conditions, hydrogen gas may be produced in a hot water system that has not been used for two weeks or more. If the hot water system has not been used for such a period, before using the washer, turn on all the hot water faucets and let the water flow from each faucet for several minutes. This will release any accumulated hydrogen gas. As this gas is flammable, do not smoke or use an open flame during this time.

Recent studies have shown that if vegetable oil contaminated materials are incompletely washed, a carry-over and buildup of the oil may contribute to a chemical reaction (spontaneous combustion) that could cause a load to catch fire by itself. This would be more likely to happen if the load were left in the dryer after tumbling stopped or if items were folded and stacked while warm.



Important Safety Instructions

⚠ WARNING

To reduce the risk of fire, explosion, electric shock, or personal injury when using your washer, follow basic safety precautions, including the following:

1. Read all instructions before using the appliance.
2. As with any equipment using electricity and having moving parts, there are potential hazards. To use this appliance safely, the operator should become familiar with the instructions for operation of the appliance and always exercise care when using it.
3. **Do not** install or store this appliance where it will be exposed to the weather.
4. Install and level washer on a floor that can support the weight.
5. This appliance must be properly grounded. Never plug the appliance cord into a receptacle which is not grounded adequately and in accordance with local and national codes. See installation instructions for grounding this appliance.
6. To avoid the possibility of fire or explosion:
 - a. **Do not** wash items that have been previously cleaned in, washed in, soaked in, or spotted with gasoline, dry-cleaning solvents, other flammable or explosive substances as they give off vapors that could ignite or explode. Hand wash and line dry any items containing these substances.

Any material on which you have used a cleaning solvent, or which is saturated with flammable liquids or solids, should not be placed in the washer until all traces of these liquids or solids and their fumes have been removed.

These items include acetone, denatured alcohol, gasoline, kerosene, some liquid household cleaners, some spot removers, turpentine, waxes and wax removers.
 - b. **Do not** add gasoline, dry-cleaning solvents, or other flammable or explosive substances to the wash water. These substances give off vapors that could ignite or explode.
 - c. Under certain conditions, hydrogen gas may be produced in a hot water system that has not been used for two weeks or more. **HYDROGEN GAS IS EXPLOSIVE.** If the hot water system has not been used for such a period, before using a washing machine or combination washer-dryer, turn on all hot water faucets and let the water flow from each for several minutes. This will release any accumulated hydrogen gas. As the gas is flammable, do not smoke or use an open flame during this time.
- d. **Do not** wash or dry items that are soiled with vegetable or cooking oil. These items may contain some oil after laundering. Due to the remaining oil, the fabric may smoke or catch fire by itself.
7. **Do not** reach into the appliance if the tub or agitator is moving.
8. **Do not** allow children or pets to play on, in, or in front of the appliance. Close supervision is necessary when the appliance is used near children and pets.
9. **Do not** tamper with controls.
10. **Do not** repair or replace any part of the appliance or attempt any servicing unless specifically recommended in published user-repair instructions that you understand and have the skills to carry out.
11. Unplug power supply cord before attempting to service your washer. Service is to be done only by qualified service personnel.
12. The agitator should not be removed. If the agitator is removed, it must be replaced by pushing down completely and the locking screw tightened before the washer is operated.
13. Keep all laundry aids such as detergents, bleach, etc., out of the reach of children, preferably in a locked cabinet. Use laundry aids only as directed by the manufacturer. Observe all warnings on container labels.
14. Keep the area around and underneath washer free from the accumulation of combustible materials, such as lint, paper, rags, gasoline, and all other flammable vapors and liquids.
15. **Do not** use chlorine bleach and ammonia or acids (such as vinegar or rust remover) in the same wash. Hazardous fumes can form.
16. **Do not** machine wash fiberglass materials. Small particles can stick to fabrics washed in following loads and cause skin irritation.
17. For flame resistant finishes - follow garment manufacturer's instructions carefully. Improper laundering could remove the finish.
18. Before the appliance is removed from service or discarded, remove the door to the washing compartment.
19. Inlet hoses are subject to damage and deterioration over time. Check the hoses periodically for bulges, kinks, cuts, wear or leaks and replace them every five years.

SAVE THESE INSTRUCTIONS



Using the Controls - 2 Speed Combo Models

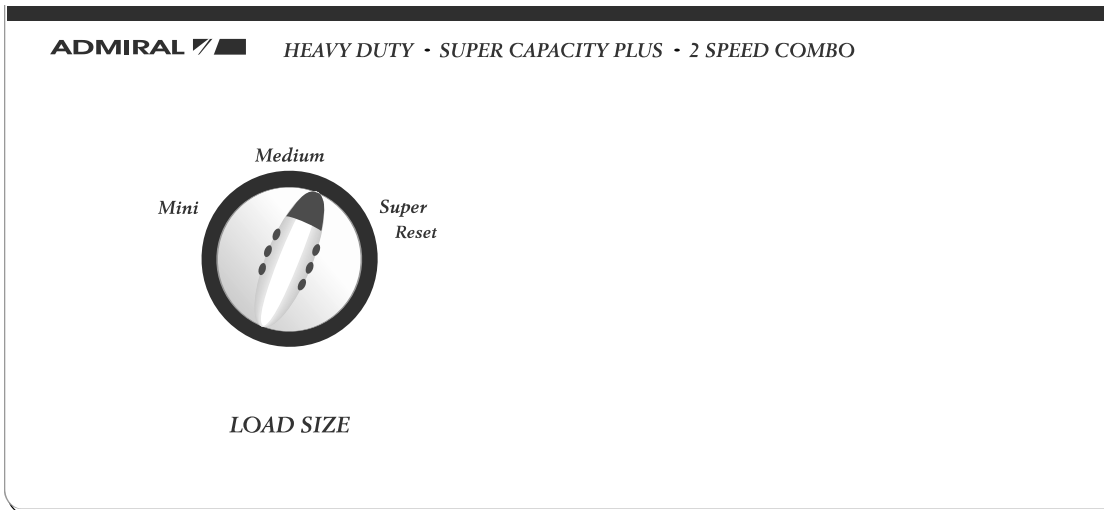

STEP 1

Select LOAD SIZE

Determine the selected setting based on load size. Selection should provide sufficient water to permit clothes to circulate freely during agitation.

It may become necessary, due to bulky fabrics, to adjust the water level after agitation begins. To adjust the water level, turn the control to **Reset** and then back to the desired setting.

WATER LEVEL SETTING	LOAD SIZE
Mini (select models)	1/4 Full
Medium	1/4 - 3/4
Super	3/4 - Full

Note: Items must circulate freely for best results.

STEP 2

Select Cycle and Water Temperature

To select a cycle and water temperature, push the control dial **in** (off position) and turn it to the **right** (clockwise) until the pointer is at the number of minutes and water temperature needed for the wash load in the COTTONS, WRINKLE-FREE FABRICS or DELICATES cycles. All rinses use cold water.

COTTONS Cycle

Used to wash Cottons and heavily soiled items.

WRINKLE-FREE FABRICS Cycle

Used to minimize wrinkles with a cool-down spray rinse following the wash.

DELICATES Cycle

Used for items requiring delicate wash action. The washer will fill, then agitate and soak alternately.

Note: In wash water temperatures below 60° F (16° C), detergents **do not** dissolve well or clean well. Care labels define cold water as up to 85° F (29° C).

Control features vary by model.

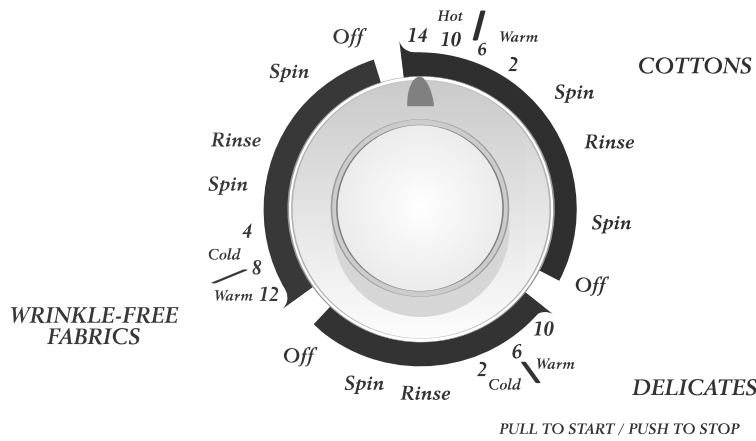

CYCLE	TIME	TEMPS
COTTONS	14	Hot/Cold
	10	
	6	Warm/Cold
	2	
WRINKLE-FREE FABRICS	12	Warm/Cold
	8	
	4	
DELICATES	10	Warm/Cold
	6	
	2	

STEP 3

Pull Control Dial Out to Start

You may stop the washer at any time by simply pushing the control dial **in**. Therefore it is possible to obtain a non-agitated soak or to shorten, skip or repeat any part of a cycle. The control dial must be pushed **in** (off position) when you change the setting.

Note: Do not attempt to turn the control dial *counterclockwise*. Damage to the timer will result.



Using the Controls - 3 Speed Combo Models

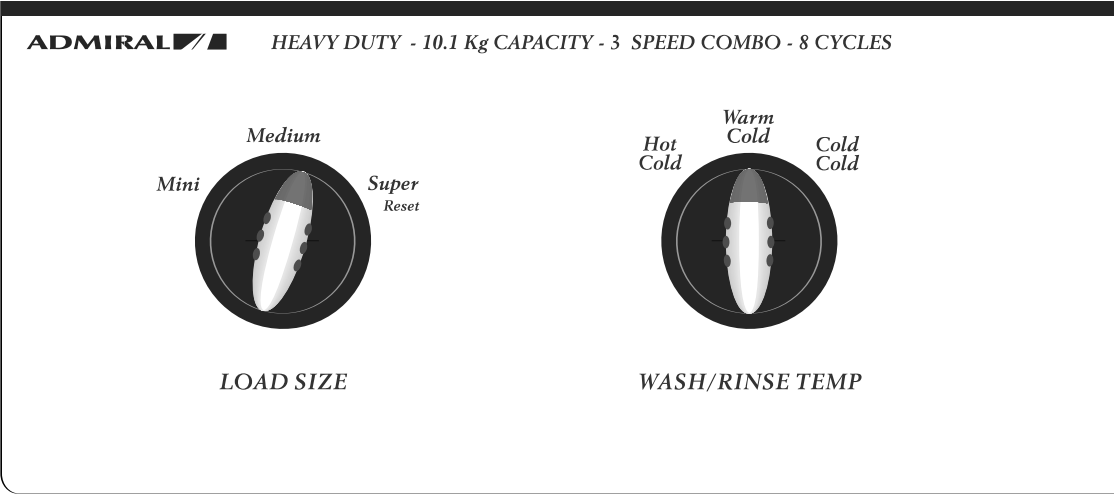

STEP 1

Select LOAD SIZE

Determine the selected setting based on clothes load size. Selection should provide sufficient water to permit clothes to circulate freely during agitation.

It may become necessary, due to bulky fabrics, to adjust the water level after agitation begins. To adjust the water level, turn the control to **reset** and then back to the desired setting.

WATER LEVEL SETTING	LOAD SIZE
Mini (select models)	1/4 Full
Medium	1/4 - 3/4
Super	3/4 - Full

Note: Items must circulate freely for best results.

STEP 2

Select WASH/RINSE TEMP

Your washer gives you a choice of hot, warm or cold water for washing and cold water for rinsing. Use the chart below as a guide.

WASH/RINSE TEMPS	LOAD TYPE
Hot/Cold	White and heavily soiled, color-fast items.
Warm/Cold	Moderately soiled, colored items; most wrinkle-free items.
Cold/Cold	Brightly colored, lightly soiled items; washable woolens.

Note: In wash water temperatures below 60° F (16° C), detergents **do not** dissolve well or clean well. Care labels define cold water as up to 85° F (29° C).

Control features vary by model.

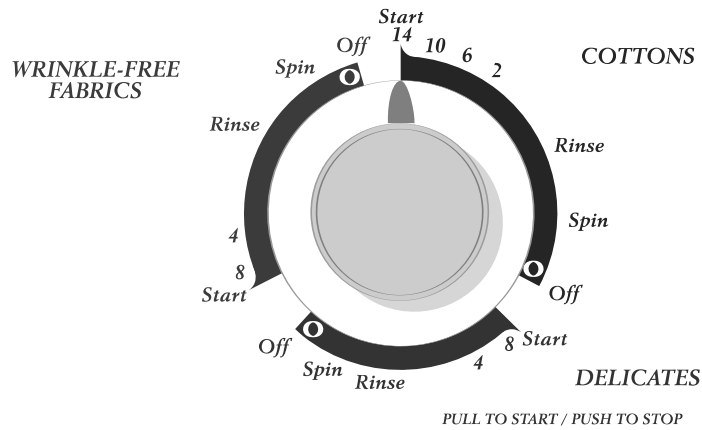

STEP 3

Select Cycle

To select a cycle, push the control dial **in** (off position) and turn it to the *right* (clockwise) until the pointer is at the number of minutes needed for the wash load in the COTTONS Fabrics, WRINKLE-FREE FABRICS or DELICATES cycles.

COTTONS Cycle

Provides normal agitation and normal spin speeds to wash cottons and heavily soiled items. For maximum cleaning, set the dial at 14 minutes.

WRINKLE-FREE FABRICS Cycle

Provides normal agitation speed and normal spin speed with a spray rinse to protect wrinkle-free fabrics.

DELICATES Cycle

Provides slow agitation speed and slow spin speed for delicates and knits.

STEP 4

Pull Control Dial Out to Start

You may stop the washer at any time by simply pushing the control dial **in**. Therefore it is possible to obtain a non-agitated soak or to shorten, skip or repeat any part of a cycle. The control dial must be pushed **in** (off position) when you change the setting.

Note: Do not attempt to turn the control dial *counterclockwise*. Damage to the timer will result.



Using the Controls - 4 Speed Combo Models

ADMIRAL HEAVY DUTY - 10.1 Kg CAPACITY - 4 SPEED COMBO - QUIET PACK - 13 CYCLES

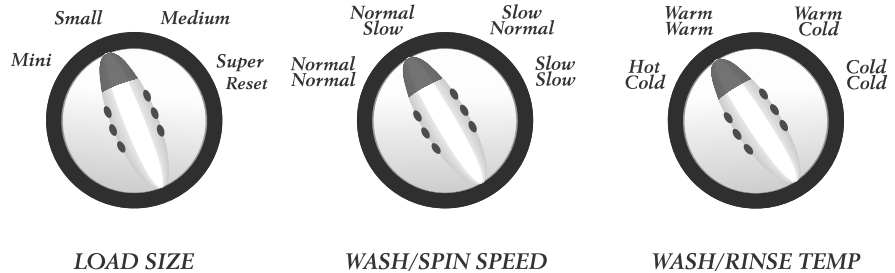

STEP 1

Select LOAD SIZE

Determine the selected setting based on load size. Selection should provide sufficient water to permit clothes to circulate freely during agitation.

It may become necessary, due to bulky fabrics, to adjust the water level after agitation begins. To adjust the water level, turn the control to **Reset** and then back to the desired setting.

WATER LEVEL SETTING	LOAD SIZE
Mini (select models)	1/4 Full
Small	1/4 - 1/2
Medium	1/2 - 3/4
Super	3/4 - Full

Note: Items must circulate freely for best results.

STEP 2

Select WASH/SPIN SPEED

Your washer has selectable wash and spin speed combinations.

WASH/SPIN SPEEDS	LOAD TYPE
Normal/Normal	Sturdy fabrics needing maximum water extraction.
Normal/Slow	Sturdy fabrics needing a slower spin speed because of wrinkling.
Slow/Normal	Heavy loads of delicate fabrics needing a fast spin for better water extraction.
Slow/Slow	Delicate fabrics needing slower wash and spin speed because of clothing construction.

STEP 3

Select WASH/RINSE TEMP

Your washer gives you a choice of hot, warm or cold water for washing and cold or warm water for rinsing. Use the chart below as a guide.

WASH/RINSE TEMPS	LOAD TYPE
Hot/Cold	White and heavily soiled, color-fast items.
Warm/Warm	Moderately soiled, colored items.
Warm/Cold	Moderately soiled, colored items; most wrinkle-free items.
Cold/Cold	Brightly colored, lightly soiled items; washable woolens.

Control features vary by model.

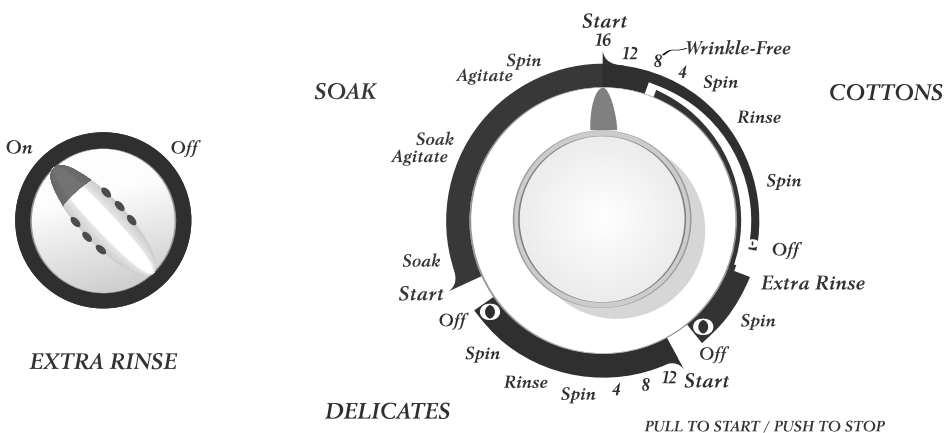

Note: In wash water temperatures below 60° F (16° C), detergents **do not** dissolve well or clean well. Care labels define cold water as up to 85° F (29° C).

STEP 4

Select Options (if desired)

EXTRA RINSE

When the knob is in the **on** position, an additional rinse at the end of the COTTONS cycle is provided to more completely remove laundry additives, suds, perfumes, etc.

END OF CYCLE SIGNAL (select models)

The end of cycle signal will sound once the cycle is completed. The end of cycle signal can be canceled by setting the switch to **Off**.

STEP 5

Select Cycle

To select a cycle, push the control dial **in** (off position) and turn it to the *right* (clockwise) until the pointer is at the number of minutes desired for the wash load.

IMPORTANT: For optimum fabric care, the appropriate wash and spin speed for the load type must be selected using the WASH/SPIN SPEED knob.

COTTONS Cycle

For regular fabrics, select the cycle time and turn the Wash/Spin Speed dial to **Normal/Normal**.

For fabrics needing a slower spin speed to reduce wrinkling, set the control dial on **Wrinkle-Free** and turn the wash/spin speed dial to **Normal/Slow**.

DELICATES Cycle

This cycle provides up to 12 minutes of agitation. Depending on the load, select either the **Slow/Slow** or **Slow/Normal** wash/spin speed.

SOAK Cycle

This cycle provides approximately 30 minutes of agitation and soaking to help remove stubborn dirt and stains. For more information see page 10.

STEP 6

Pull Control Dial Out to Start

You may stop the washer at any time by simply pushing the control dial **in**. Therefore it is possible to obtain a non-agitated soak or to shorten, skip or repeat any part of a cycle. The control dial must be pushed **in** (off position) when you change the setting.

Note: Do not attempt to turn the control dial *counterclockwise*. Damage to the timer will result.



Operating Tips

Detergent

- Use either liquid or granular laundry detergent. **For best results, be sure detergent is added to the washer BEFORE the load and be sure the wash water is above 60° F (16° C).**
- Use the correct amount of detergent for the load size, soil level and water conditions. Use more detergent if you have hard water and very soiled loads.
If you have soft water or a lightly soiled load, use less detergent. (See manufacturer's instructions.)
- Wipe up any detergent spills on the washer.

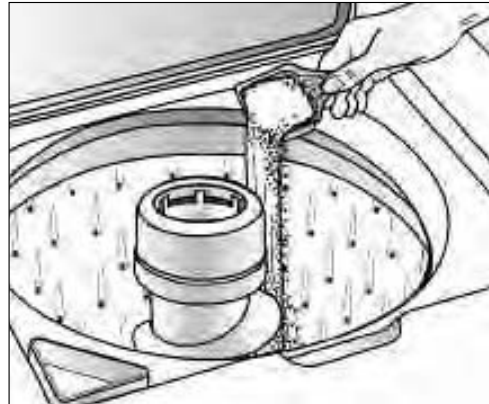

Loading

- For best results add the detergent to the washtub before adding the load.
- Put dry, unfolded clothes loosely in the tub, up to the top row of holes for a maximum load.
- **Do not** wrap large items like sheets around the agitator.
- Mix large and small items for best circulation. Wash bulky items like blankets separately.
- When laundering wrinkle-free items or items of delicate construction, washable woolens or loosely knit items, never use less than the Medium water level setting. This will minimize shrinkage, wrinkling and pulling of seams.
- Close lid carefully to avoid slamming.



Additional Tips

- During the spin, it is possible for the load to become unevenly distributed in the tub. If this happens, push **in** the control dial, open the lid, redistribute the load, close the lid and restart the washer. The spin will resume at the point it was interrupted.
- The washer will pause briefly throughout each cycle. These pauses are normal.
- This washer is designed so that it **will not** agitate or spin when the lid is open. It will, however, fill with the lid open so water is available for pretreating stains or diluting fabric softener.
- If you open the lid during a spin cycle, the washer will stop. When the lid is closed and the washer is restarted, the washer will continue the cycle at the point it was interrupted.

Special Features

Liquid Bleach Dispenser

The dispenser automatically dilutes liquid chlorine bleach before it reaches your wash load.

To use, follow these steps:

1. Measure liquid chlorine bleach carefully, following the instructions on the bottle.
2. **Pour liquid chlorine bleach into bleach dispenser before adding the load.** Avoid splashing or over-filling the dispenser.



Notes:

- **Never** pour undiluted liquid chlorine bleach directly onto the load or into the wash tub. It is a powerful chemical and can cause fabric damage, such as tearing or color loss, if not used properly.
- If you prefer to use color-safe, non-chlorine bleach, pour it into the wash tub with your detergent. **Do not** pour non-chlorine bleaches into the bleach dispenser.

Liquid Dispenser (select models)

The dispenser may be used for fabric softener with most cycles or liquid detergent with the SOAK cycle (select models). The liquid dispenser should be cleaned before and after each use of liquid detergent. The dispenser automatically releases the liquid at the proper time during the cycle.

To use, follow these steps:

1. Pour a measured amount of desired liquid into the dispenser to fill line only.
2. If liquid comes below line, add warm water.

If it is necessary to clean the dispenser:

1. Pull the dispenser off of the top of the agitator.
2. Soak for one hour (in sink or container) in hot water and dishwashing liquid.
3. Hold hands over top and bottom of dispenser and shake to loosen buildup.
4. Rinse with clean, hot water.
5. Repeat process if necessary.
6. Replace dispenser on agitator.



Do not use dishwashing liquid inside the washer. Oversudsing can occur.

SOAK Cycle (select models)

This cycle eliminates the inconvenience of soaking stained loads before they are placed in the washer.

To use, follow these steps:

1. Add liquid or granular detergent to the washtub.
2. Add the load.
3. Add **liquid detergent only** to the Liquid Dispenser in the top of the agitator.
4. Set the control dial to **Start** in the SOAK Cycle.

The load will soak for 30 minutes with brief periods of agitation. The water is then spun out and clean wash water is added along with the liquid detergent for a 16-minute wash cycle.

Safety Spin

If for any reason you open the washer lid when the washer is in a spin or extract period, the operation will immediately stop. This is for your personal safety. If your washer does not stop, call your service technician immediately. When the lid is closed, the operation will automatically resume.

Finger Faucet (select models)

Provides a flow of water when holding the switch in the **On** position.

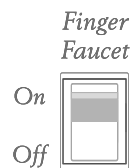



Special Features

Automatic Lint Filtering System

The Lint Filtering System does not require cleaning.

Wash and rinse water is filtered and re-filtered continuously to trap lint shed by most fabrics during the agitation cycle before it can be redeposited on the wash load. The engineered hole design on the wash basket, in conjunction with water flow produced by the agitator, traps lint away from the clothes between the inner wash basket and the outer tub. Lint is automatically flushed from the washer during the spin cycle.

Unbalanced Spin Load Compensator

Your new washer is designed to handle out-of-balance loads without shutting down or interrupting the washing cycle.

For this reason, the cycle will always be completed. If heavier fabrics in such out-of-balance loads should ever contain excessive moisture at the completion of the cycle, redistribute the clothes in the washer and reset the control dial for the final spin period.

Overload Protector

A built-in protector automatically shuts off the washer motor in case of an overload. This can occur if:

- The load being washed is too heavy.
- Too many appliances are plugged into the line operating your washer.
- A low voltage condition exists on the line.
- Lid is opened and closed repeatedly.

The overload protector permits the washer to start again when the motor has cooled to a safe operating temperature. If the motor stops repeatedly, call your service technician.



Care & Cleaning

1. After washing, leave the lid open until the interior is dry.
2. Check hoses to be sure there are no kinks or knots.
3. Your washer **should not** be installed where temperatures will go below freezing, as damage to the washer could result.
4. To clean, occasionally wipe exterior with a clean damp sponge or cloth. **Do not** use polish on plastic parts.
5. Lifetime lubrication is done at the factory, so your washer never needs to be oiled or greased.
6. **Do not** lay heavy or sharp objects on top of your washer.
7. The top of the washer **should not** be used for removing stains from garments. Some stain removers, such as rust remover, will mar the finish.
8. Remove pins, buckles or other sharp objects from clothes to prevent scratching interior parts.
9. Clothes **should not** be stored in washer.
10. Bleach, detergent, solvents, etc. spilled on the top of your washer that are allowed to remain will remove the glossy finish. Remove all spills with a damp, soft cloth.

11. If you close your home for the winter, have a service technician drain the washer. Unplug cord from electrical outlet and disconnect hoses from faucets.

Cleaning the Interior

Clean the interior of the washer periodically to remove any dirt, soil, odor, mold, mildew or bacteria residue that may remain in the washer as a result of washing clothes. We recommend taking the following steps every 60 to 120 days to clean and freshen your washer interior. The frequency with which the washer should be cleaned and freshened depends on factors such as usage, the amount of dirt, soil or bacteria being run through your washer, or the use of cold water. Failure to follow these instructions may result in unsatisfactory conditions, including unpleasant odor and/or permanent stains on the washer or wash load.

To clean and freshen the washer interior:

1. Add a measured amount of chlorine bleach to the bleach dispenser, following package directions.
2. Add 1/4 cup of detergent to the tub.
3. Run the washer without a load through a complete cycle using hot water.
4. Repeat the process if necessary.

Troubleshooting

Won't Fill	<ul style="list-style-type: none"> • Plug cord into live electrical outlet. • Check fuse or reset circuit breaker. • Turn the control dial to proper cycle and restart the washer. • Turn both faucets on fully. • Straighten inlet hoses. • Disconnect hoses and clean screens. Hose filter screens may be plugged.
Won't Agitate	<ul style="list-style-type: none"> • Check fuse or reset circuit breaker. • Make sure the lid is completely closed. • Turn the control dial to proper cycle and restart the washer. • Pauses are normal. Wait and see if the washer will start again.
Won't Spin or Drain	<ul style="list-style-type: none"> • Check fuse or reset circuit breaker. • Straighten drain hoses. Eliminate kinked hoses. If there is a home drain restriction, call for drain service. • Close lid and restart the washer. For your safety, washer will not spin unless the lid is closed. • Suds lock – caused by too much suds. Rewash without detergent. Use correct amount of a low-sudsing detergent.
Load is Wet	<ul style="list-style-type: none"> • Unevenly distributed load. Redistribute the load, close the lid and restart the washer. Check for leveling. Be sure water level is acceptable for load size. • A normal spin speed is recommended for heavy loads like jeans or towels.
Stops	<ul style="list-style-type: none"> • Plug cord into live electrical outlet. • Check fuse or reset circuit breaker. • Close lid and restart the washer. For your safety, washer will not agitate or spin unless lid is closed. • This may be a pause in the cycle. Wait briefly and it may start.
Leaks Water	<ul style="list-style-type: none"> • Make sure hose connections are tight. • Make sure end of drain hose is correctly inserted and secured to drain facility. • Avoid extended soaking – soak for 30 minutes or less. • Avoid overloading.
Is Noisy	<ul style="list-style-type: none"> • Be sure washer is leveled properly as outlined in installation manual. • Weak floors can cause vibration and walking. • Operating sounds will vary depending on agitation speed.
Fills with the Wrong Temperature Water	<ul style="list-style-type: none"> • Turn both faucets on fully. • If equipped with a temperature selector dial, be sure it is set directly on a temperature setting and not between settings. • Make sure temperature selection is correct. • Make sure hoses are connected to correct faucets and inlet connections. Be sure water supply is regulated correctly. Flush water line before filling washer. • Check the water heater. It should be set to deliver a minimum 120° F (49° C) hot water at the tap. Also check water heater capacity and recovery rate. • Disconnect hoses and clean screens. Hose filter screens may be plugged.
Cycle Selector Advances Through Off	<ul style="list-style-type: none"> • EXTRA RINSE (select models) is selected.

NOTES

Clothes Washer

Use & Care Guide

CW-3

CROSLEY



Table of Contents



Important Safety Instructions 1-2



Using the Controls
3 Speed Combo Models 3-4
3 Speed Combo with
Stain Cleaner Models 5-6



Operating Tips 7



Special Features 8-9



Care & Cleaning 9



Troubleshooting 10





Important Safety Instructions

Installer: Please leave this guide with this appliance.

Consumer: Please read and keep this guide for future reference. Keep sales receipt and/or canceled check as proof of purchase.

Model Number _____

Serial Number _____

Date of Purchase _____

If you have questions, call:

Customer Assistance

1-800-688-9900 U.S.A.

1-800-688-2002 Canada

(Mon.-Fri., 8am-8pm Eastern Time)

Internet: <http://www.amana.com>

U.S. Customers using TTY for deaf, hearing impaired or speech impaired, call 1-800-688-2080.

In our continuing effort to improve the quality and performance of our appliances, it may be necessary to make changes to the appliance without revising this guide.

For service information, see page 15.

What You Need to Know About Safety Instructions

Warning and Important Safety Instructions appearing in this guide are not meant to cover all possible conditions and situations that may occur. Common sense, caution and care must be exercised when installing, maintaining or operating appliance.

Always contact the manufacturer about problems or conditions you do not understand.

Recognize Safety Symbols, Words, Labels

WARNING

WARNING – Hazards or unsafe practices which **COULD** result in severe personal injury or death.

CAUTION

CAUTION – Hazards or unsafe practices which **COULD** result in minor personal injury.

WARNING! FIRE HAZARD

Do not add gasoline, dry-cleaning solvents, or other flammable or explosive substances to the wash water. These substances give off vapors that could ignite or explode.

Do not wash articles which have been previously cleaned, washed, soaked, or spotted with gasoline, dry-cleaning solvents, oil, waxes, chemical solvents, alcohol, turpentine, or other flammable or explosive materials. These substances will be retained in articles, and articles which still contain these flammable or explosive substances give off vapors that could ignite or explode.

Observe these precautions when using cleaning fluids, spot or stain removers, etc. These products should be labeled “nonflammable.” Use according to manufacturers directions in a well ventilated area or outdoors. Thoroughly rinse articles by hand before placing them in the washer. Some of these products – rust removers for example – will damage components and the finish of the washer.

Keep area around and underneath washer free from the accumulation of combustible materials, such as lint, paper, rags, gasoline, and all other flammable vapors and liquids.

HYDROGEN GAS IS EXPLOSIVE! Under certain conditions, hydrogen gas may be produced in a hot water system that has not been used for two weeks or more. If the hot water system has not been used for such a period, before using the washer, turn on all the hot water faucets and let the water flow from each faucet for several minutes. This will release any accumulated hydrogen gas. As this gas is flammable, do not smoke or use an open flame during this time.

Recent studies have shown that if vegetable oil contaminated materials are incompletely washed, a carry-over and buildup of the oil may contribute to a chemical reaction (spontaneous combustion) that could cause a load to catch fire by itself. This would be more likely to happen if the load were left in the dryer after tumbling stopped or if items were folded and stacked while warm.



Important Safety Instructions

⚠ WARNING

To reduce the risk of fire, explosion, electric shock, or personal injury when using your washer, follow basic safety precautions, including the following:

1. Read all instructions before using the appliance.
2. As with any equipment using electricity and having moving parts, there are potential hazards. To use this appliance safely, the operator should become familiar with the instructions for operation of the appliance and always exercise care when using it.
3. **Do not** install or store this appliance where it will be exposed to the weather.
4. Install and level washer on a floor that can support the weight.
5. This appliance must be properly grounded. Never plug the appliance cord into a receptacle which is not grounded adequately and in accordance with local and national codes. See installation instructions for grounding this appliance.
6. To avoid the possibility of fire or explosion:
 - a. **Do not** wash items that have been previously cleaned in, washed in, soaked in, or spotted with gasoline, dry-cleaning solvents, other flammable or explosive substances as they give off vapors that could ignite or explode. Hand wash and line dry any items containing these substances.

Any material on which you have used a cleaning solvent, or which is saturated with flammable liquids or solids, should not be placed in the washer until all traces of these liquids or solids and their fumes have been removed.

These items include acetone, denatured alcohol, gasoline, kerosene, some liquid household cleaners, some spot removers, turpentine, waxes and wax removers.
 - b. **Do not** add gasoline, dry-cleaning solvents, or other flammable or explosive substances to the wash water. These substances give off vapors that could ignite or explode.
 - c. Under certain conditions, hydrogen gas may be produced in a hot water system that has not been used for two weeks or more. **HYDROGEN GAS IS EXPLOSIVE.** If the hot water system has not been used for such a period, before using a washing machine or combination washer-dryer, turn on all hot water faucets and let the water flow from each for several minutes. This will release any accumulated hydrogen gas. As the gas is flammable, do not smoke or use an open flame during this time.
- d. **Do not** wash or dry items that are soiled with vegetable or cooking oil. These items may contain some oil after laundering. Due to the remaining oil, the fabric may smoke or catch fire by itself.
7. **Do not** reach into the appliance if the tub or agitator is moving.
8. **Do not** allow children or pets to play on, in, or in front of the appliance. Close supervision is necessary when the appliance is used near children and pets.
9. **Do not** tamper with controls.
10. **Do not** repair or replace any part of the appliance or attempt any servicing unless specifically recommended in published user-repair instructions that you understand and have the skills to carry out.
11. Unplug power supply cord before attempting to service your washer. Service is to be done only by qualified service personnel.
12. The agitator should not be removed. If the agitator is removed, it must be replaced by pushing down completely and the locking screw tightened before the washer is operated.
13. Keep all laundry aids such as detergents, bleach, etc., out of the reach of children, preferably in a locked cabinet. Use laundry aids only as directed by the manufacturer. Observe all warnings on container labels.
14. Keep the area around and underneath washer free from the accumulation of combustible materials, such as lint, paper, rags, gasoline, and all other flammable vapors and liquids.
15. **Do not** use chlorine bleach and ammonia or acids (such as vinegar or rust remover) in the same wash. Hazardous fumes can form.
16. **Do not** machine wash fiberglass materials. Small particles can stick to fabrics washed in following loads and cause skin irritation.
17. For flame resistant finishes - follow garment manufacturer's instructions carefully. Improper laundering could remove the finish.
18. Before the appliance is removed from service or discarded, remove the door to the washing compartment.
19. Inlet hoses are subject to damage and deterioration over time. Check the hoses periodically for bulges, kinks, cuts, wear or leaks and replace them every five years.

SAVE THESE INSTRUCTIONS



Using the Controls - 3 Speed Combo Models

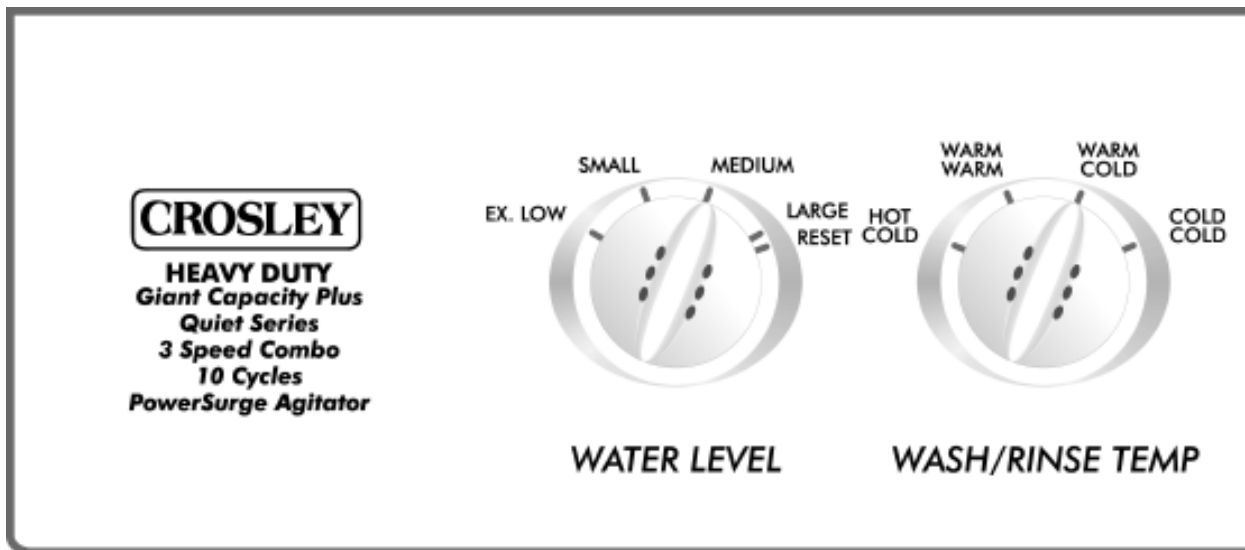

CROSLLEY
HEAVY DUTY
Giant Capacity Plus
Quiet Series
3 Speed Combo
10 Cycles
PowerSurge Agitator

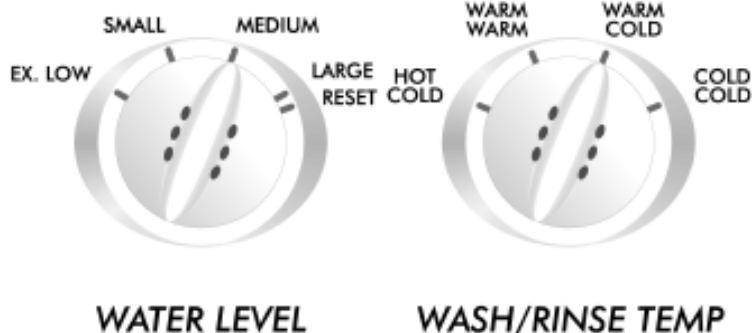

STEP 1

Select Water Level

Determine the selected setting based on clothes load size. Selection should provide sufficient water to permit clothes to circulate freely during agitation.

It may become necessary, due to bulky fabrics, to adjust the water level after agitation begins. To adjust the water level, turn the control to **reset** and then back to the desired setting.

WATER LEVEL SETTING	LOAD SIZE
Ex. Low (select models)	1/4 Full
Small	1/4 - 1/2 Full
Medium	1/2 - 3/4 Full
Large	3/4 - Full

Note: Items must circulate freely for best results.

STEP 2

Select Wash/Rinse Temperature

Your washer gives you a choice of hot, warm or cold water for washing and cold or warm water (select models) for rinsing. Use the chart below as a guide.

WASH/RINSE TEMPS	LOAD TYPE
Hot/Cold	White and heavily soiled, color-fast items.
Warm/Warm (select models)	Moderately soiled, colored items.
Warm/Cold	Moderately soiled, colored items; most wrinkle-free items.
Cold/Cold	Brightly colored, lightly soiled items; washable woolens.

Note: In wash water temperatures below 60° F, detergents do not dissolve well or clean well. Care labels define cold water as up to 85° F.

Control features vary by model.



STEP 3

Select Extra Rinse (if desired) (select models)

When the knob is in the **On** position, an additional rinse at the end of the Regular cycle is provided to more completely remove laundry additives, suds, perfumes, etc.

STEP 4

Select Cycle

To select a cycle, push the control dial **in** (off position) and turn it to the *right* until the pointer is at the number of minutes needed for the wash load in the Regular, Wrinkle-Free Clothes or Delicates cycles.

Regular Cycle

Provides normal agitation and normal spin speeds to wash cottons and heavily soiled items.

Wrinkle-Free Clothes Cycle

Provides normal agitation speed for the first six minutes, a pause, then slow agitation for the rest of the wash cycle to protect wrinkle-free fabrics. Spin speed will be normal to reduce water retention.

Delicates Cycle

Provides slow agitation speed and slow spin speed for delicates and knits.

STEP 5

Pull Control Dial Out to Start

You may stop the washer at any time by simply pushing the control dial **in**. Therefore it is possible to obtain a non-agitated soak or to shorten, skip or repeat any part of a cycle. The control dial must be pushed **in** (off position) when you change the setting.

Note: Do not attempt to turn the control dial counterclockwise. Damage to the timer will result.



Using the Controls - 3 Speed Combo with Stain Cleaner Models

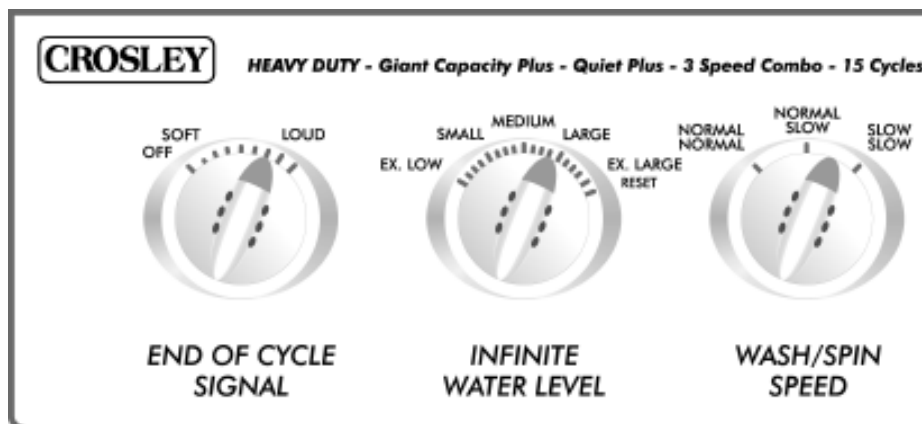

STEP 1

Select Signal

End of Cycle Signal

When the cycle is complete, a signal will sound several times. The End of Cycle Signal volume is adjustable. To adjust the volume, select any setting between **OFF** and **LOUD**.

STEP 2

Select Water Level

Determine the selected setting based on clothes load size. Selection should provide sufficient water to permit clothes to circulate freely during agitation.

It may become necessary, due to bulky fabrics, to adjust the water level after agitation begins. To adjust the water level, turn the control to **reset** and then back to the desired setting.

WATER LEVEL SETTING	LOAD SIZE
Ex. Low	1/4 Full
Small	1/4 - 1/3
Medium	1/3 - 1/2
Large	1/2 - 2/3
Extra Large	3/4 - Full

Note: Items must circulate freely for best results.

STEP 3

Select Wash/Spin Speed

Your washer has selectable wash and spin speed combinations.

WASH/SPIN SPEEDS	LOAD TYPE
Normal/Normal	Sturdy fabrics needing maximum water extraction.
Normal/Slow	Sturdy fabrics needing a slower spin speed because of wrinkling.
Slow/Slow	Delicate fabrics needing slower wash and spin speed because of clothing construction.

STEP 4

Select Wash/Rinse Temperature

Your washer gives you a choice of hot, warm or cold water for washing and cold or warm water for rinsing. Use the chart below as a guide.

WASH/RINSE TEMPS	LOAD TYPE
Hot/Cold	White and heavily soiled, color-fast items.
Warm/Cold	Moderately soiled, colored items; most wrinkle-free items.
Cold/Cold	Brightly colored, lightly soiled items; washable woolens.

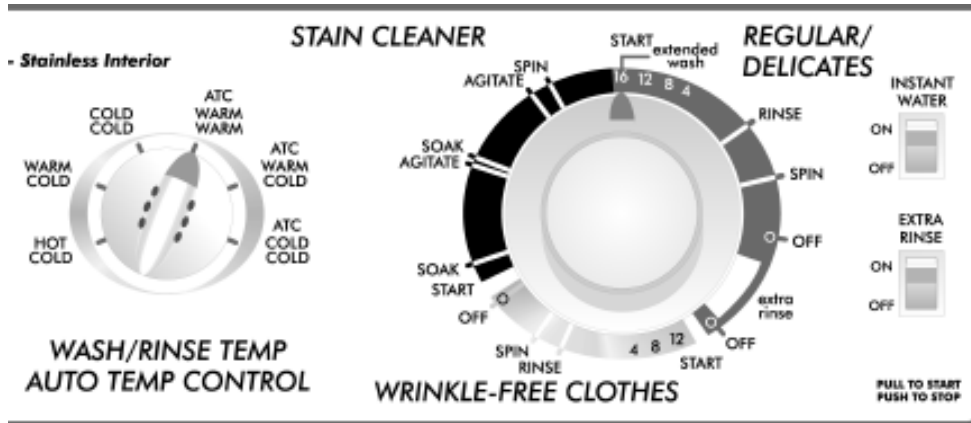

WASH/RINSE TEMPS	LOAD TYPE
These settings feature Automatic Temperature Control:	
ATC Warm/Warm ATC Warm/Cold	Saves energy by adding cold water to the hot water from your water heater. Provides optimum cleaning at lower temperatures.
ATC Cold/Cold	May add hot water to the incoming cold water as the washer fills. This assures that the water will be warm enough to properly activate detergent.

Note: In wash water temperatures below 60° F, detergents do not dissolve well or clean well.

STEP 5

Select Cycle

To select a cycle, push the control dial **in** and turn it to the *right* (clockwise) until the pointer is at the number of minutes desired for the wash load.

IMPORTANT: For optimum fabric care, the appropriate wash and spin speed for the load type must be selected using the Wash/Spin Speed knob.

Regular/Delicates Cycle

Regular/Delicates cycles share the same portion of the control dial. For regular fabrics, select the cycle and turn the Wash/Spin Speed dial to Normal/Normal. For delicate loads, select Slow/Slow.

Wrinkle-Free Clothes Cycle

This cycle provides up to 12 minutes of agitation. Depending on the load, select either the **Normal/Slow** or **Slow/Slow** wash/spin speed.

Stain Cleaner Cycle

Stain Cleaner provides approximately 30 minutes of agitation and soaking to help remove stubborn dirt and stains. For more information see page 8.

STEP 6

Select Extra Rinse (if desired)

When the switch is in the **On** position, an additional rinse at the end of the Regular/Delicates cycle is provided to more completely remove laundry additives, suds, perfumes, etc.

STEP 7

Pull Control Dial Out to Start

You may stop the washer at any time by simply pushing the control dial **in**. Therefore it is possible to obtain a non-agitated soak or to shorten, skip or repeat any part of a cycle. The control dial must be pushed **in** (off position) when you change the setting.

Note: Do not attempt to turn the control dial counterclockwise. Damage to the timer will result.



Operating Tips

Detergent

- Use either liquid or granular laundry detergent. **For best results, be sure detergent is added to the washer BEFORE the load and be sure the wash water is above 60° F.**
- Use the correct amount of detergent for the load size, soil level and water conditions. Use more detergent if you have hard water and very soiled loads.
If you have soft water or a lightly soiled load, use less detergent. (See manufacturer's instructions.)
- Wipe up any detergent spills on the washer.

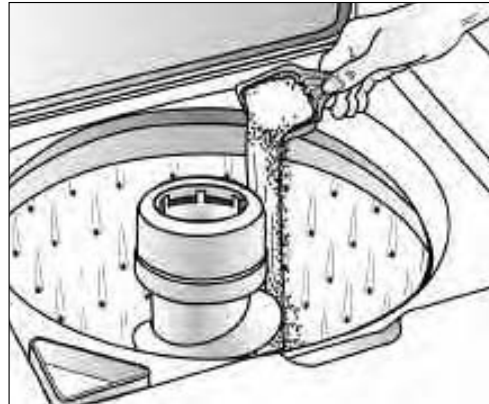

Loading

- For best results add the detergent to the washtub before adding the load.
- Put dry, unfolded clothes loosely in the tub, up to the top row of holes for a maximum load.
- **Do not** wrap large items like sheets around the agitator.
- Mix large and small items for best circulation. Wash bulky items like blankets separately.
- When laundering wrinkle free items or items of delicate construction, washable woolens or loosely knit items, never use less than the MEDIUM water level setting. This will minimize shrinkage, wrinkling and pulling of seams.
- Close lid carefully to avoid slamming.

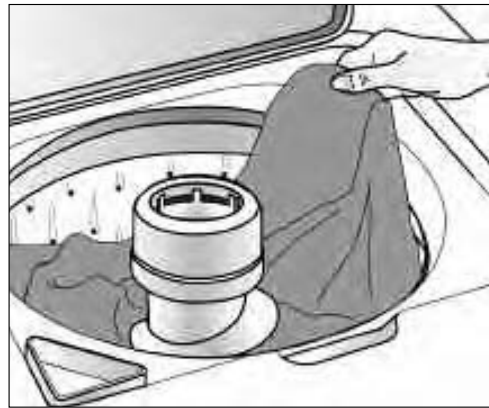

Additional Tips

- During the spin, it is possible for the load to become unevenly distributed in the tub. If this happens, push **in** the control knob, open the lid, redistribute the load, close the lid and pull out the control knob. The spin will resume at the point it was interrupted.
- The washer will pause briefly throughout each cycle. These pauses are normal.
- This washer is designed so that it will not agitate or spin when the lid is open. It will, however, fill with the lid open so water is available for pretreating stains or diluting fabric softener.
- If you open the lid during a spin cycle, the washer will stop. When the lid is closed and the control dial pulled out, the washer will continue the cycle at the point it was interrupted.



Special Features

Liquid Bleach Dispenser

The dispenser automatically dilutes liquid chlorine bleach before it reaches your wash load. To use, follow these steps:

1. Measure liquid chlorine bleach carefully, following the instructions on the bottle.
2. **Pour liquid chlorine bleach into bleach dispenser before adding the load.** Avoid splashing or over-filling the dispenser.



Pour liquid chlorine bleach into bleach dispenser.

Note:

- Never pour undiluted liquid chlorine bleach directly onto the load or into the wash tub. It is a powerful chemical and can cause fabric damage, such as tearing or color loss, if not used properly.
- If you prefer to use color-safe, non-chlorine bleach, pour it into the wash tub with your detergent. **Do not** pour non-chlorine bleach into the bleach dispenser.

Instant Water (select models)

Provides a flow of water when holding the switch in the **On** position.



Liquid Dispenser

The dispenser may be used for fabric softener with most cycles or liquid detergent with the Stain Cleaner cycle (select models). The liquid dispenser should be cleaned before and after each use of liquid detergent. The dispenser automatically releases the liquid at the proper time during the cycle.

To use, follow these steps:

1. Pour a measured amount of desired liquid into the dispenser to fill line only.
2. If liquid comes below line, add warm water.

If it is necessary to clean the dispenser:

1. Pull the dispenser off of the top of the agitator.
2. Soak for one hour in sink or container in hot water and dishwashing liquid.
3. Hold hands over top and bottom of dispenser and shake to loosen buildup.
4. Rinse with clean, hot water.
5. Repeat process if necessary.
6. Replace dispenser on agitator.



Do not use dishwashing liquid inside the washer. Oversudsing can occur.

Stain Cleaner Cycle (select models)

The Stain Cleaner cycle eliminates the inconvenience of soaking stained loads before they are placed in the washer. To use:

1. Add liquid or granular detergent to the washtub.
2. Add the load.
3. Add **liquid detergent only** to the Liquid Dispenser in the top of the agitator.
4. Set the control dial to Start in the Stain Cleaner cycle.

The load will soak for 30 minutes with brief periods of agitation. The water is then spun out and clean wash water is added along with the liquid detergent for a 16-minute wash cycle.

Safety Spin

If for any reason you open the washer lid when the washer is in a spin or extract period, the operation will immediately stop. This is for your personal safety. If your washer does not stop, call your service technician immediately. When the lid is closed, the operation will automatically resume.



Special Features

Automatic Lint Filtering System

The Lint Filtering System does not require cleaning.

Wash and rinse water is filtered and re-filtered continuously to trap lint shed by most fabrics during the agitation cycle before it can be redeposited on the wash load. The engineered hole design on the wash basket in conjunction with water flow produced by the agitator, traps lint away from the clothes between the inner wash basket and the outer tub. Lint is automatically flushed from the washer during the spin cycle.

Unbalanced Spin Load Compensator

Your new washer is designed to handle out-of-balance loads without shutting down or interrupting the washing cycle.

For this reason, the cycle will always be completed. If heavier fabrics in such out-of-balance loads should ever contain excessive moisture at the completion of the cycle, redistribute the clothes in the washer and reset the control dial for the final spin period.

Overload Protector

A built-in protector automatically shuts off the washer motor in case of an overload. This can occur if:

- The load being washed is too heavy.
- Too many appliances are plugged into the line operating your washer.
- A low voltage condition exists on the line.
- Lid is opened and closed repeatedly.

The overload protector permits the washer to start again when the motor has cooled to a safe operating temperature. If the motor stops repeatedly, call your service technician.



Care & Cleaning

1. After washing, leave the lid open until the interior is dry.
2. Check hoses to be sure there are no leaks, kinks or knots.
3. Your washer should not be installed where temperatures will go below freezing, as damage to the washer could result.
4. To clean, occasionally wipe exterior with a clean damp sponge or cloth. **Do not** use polish on plastic parts.
5. Lifetime lubrication is done at the factory, so your washer never needs to be oiled or greased.
6. **Do not** lay heavy or sharp objects on top of your washer.
7. The top of the washer should not be used for removing stains from garments. Some stain removers, such as rust remover, will mar the finish.
8. Remove pins, buckles or other sharp objects from clothes to prevent scratching interior parts.
9. Clothes should not be stored in washer.
10. Bleach, detergent, solvents, etc. spilled on the top of your washer that are allowed to remain will remove the glossy finish. Remove all spills with a damp, soft cloth.
11. If you close your home for the winter, have a service technician drain the washer. Unplug cord from electrical outlet and disconnect hoses from faucets.

Cleaning the Interior

Clean the interior of the washer periodically to remove any dirt, soil, odor, mold, mildew or bacteria residue that may remain in the washer as a result of washing clothes. We recommend taking the following steps every 60 to 120 days to clean and freshen your washer interior. The frequency with which the washer should be cleaned and freshened depends on factors such as usage, the amount of dirt, soil or bacteria being run through your washer, or the use of cold water. Failure to follow these instructions may result in unsatisfactory conditions, including unpleasant odor and/or permanent stains on the washer or washload.

To clean and freshen the washer interior:

1. Add a measured amount of chlorine bleach to the bleach dispenser, following package directions.
2. Add 1/4 cup of detergent to the tub.
3. Run the washer without a load through a complete cycle using hot water.
4. Repeat the process if necessary.



Troubleshooting

Won't Fill	<ul style="list-style-type: none"> • Plug cord into live electrical outlet. • Check fuse or reset circuit breaker. • Turn the control knob to proper cycle and pull knob out to start the washer. • Turn both faucets on fully. • Straighten inlet hoses. • Disconnect hoses and clean screens. Hose filter screens may be plugged.
Won't Agitate	<ul style="list-style-type: none"> • Check fuse or reset circuit breaker. • Make sure the lid is completely closed. • Turn the control knob to proper cycle and pull knob out to start the washer. • Pauses are normal. Wait and see if the washer will start again.
Won't Spin or Drain	<ul style="list-style-type: none"> • Check fuse or reset circuit breaker. • Straighten drain hoses. Eliminate kinked hoses. If there is a home drain restriction, call for drain service. • Close lid and pull knob out to start the washer. For your safety, washer will not spin unless the lid is closed. • Suds lock – caused by too much suds. Rewash without detergent. Use correct amount of a low-sudsing detergent.
Load is Wet	<ul style="list-style-type: none"> • Unevenly distributed load. Redistribute the load, close the lid and reset the control dial for the final spin period. Check for leveling. Be sure water level is acceptable for load size. • A normal spin speed is recommended for heavy loads like jeans or towels.
Stops	<ul style="list-style-type: none"> • Plug cord into live electrical outlet. • Check fuse or reset circuit breaker. • Close lid and pull knob out to start the washer. For your safety, washer will not spin unless lid is closed. • This may be a pause in the cycle. Wait briefly and it may start.
Leaks Water	<ul style="list-style-type: none"> • Make sure hose connections are tight. • Make sure end of drain hose is correctly inserted and secured to drain facility. • Avoid extended soaking – soak for 30 minutes or less. • Avoid overloading.
Is Noisy	<ul style="list-style-type: none"> • Be sure washer is leveled properly as outlined in installation manual. • Weak floors can cause vibration and walking. • Operating sounds will vary depending on agitation speed.
Fills with the Wrong Temperature Water	<ul style="list-style-type: none"> • Turn both faucets on fully. • If equipped with a temperature selector dial, be sure it is set directly on a temperature setting and not between settings. • Make sure temperature selection is correct. • While the washer is filling, you may notice just hot and/or just cold water entering the tub when cold or warm wash temperatures are selected. This is a normal function of the Automatic Temperature Control (select models) feature as the washer determines the temperature of the water. • If Auto Temperature Control (select models) is selected, cold water may feel warmer than cold water from the tap. • Make sure hoses are connected to correct faucets and inlet connections. Be sure water supply is regulated correctly. Flush water line before filling washer. • Check the water heater. It should be set to deliver a minimum 120° F (49° C) hot water at the tap. Also check water heater capacity and recovery rate. • Disconnect hoses and clean screens. Hose filter screens may be plugged.
Cycle Selector Advances Through Off	<ul style="list-style-type: none"> • Extra Rinse (select models) is selected.

For further assistance contact Maytag ServicesSM, Customer Assistance: 1-800-688-9900 U.S.A. or 1-800-688-2002 Canada. U.S.A. Customers using TTY for deaf, hearing impaired or speech impaired, cal 1-800-688-2080.