

**SAMSUNG**

# WASHING MACHINE

Model code : WF306LAW/XAA

WF316LAW/XAA

WF316LAS/XAA

WF326LAS/XAA

WF306BHW/XAA

WF316BAW/XAA

WF316BAC/XAA

**WF306BAW/XAA**

**WF306C1W/XAA**

**WF316CAW/XAA**

**WF326LAW/XAA**

# *SERVICE* **MANUAL**

## WASHING MACHINE



## THE FEATURE OF PRODUCT

1. SilverCare
2. SuperSize Capacity
3. Direct Drive Motor
4. Child Lock
5. My Cycle

**SAM0108**

# CONTENTS

---

1. Precautions	
1-1. Safety Precautions .....	1-1
1-2. Precautions upon Installation .....	1-2
2. PRODUCT SPECIFICATIONS	
2-1. THE FEATURE OF PRODUCT .....	2-1
2-2. SPECIFICATIONS OF PRODUCT .....	2-2
2-3. THE COMPARATIVE SPECIFICATIONS OF PRODUCT .....	2-3
2-4. OPTION SPECIFICATIONS.....	2-4
3. OPERATING INSTRUCTIONS AND INTALLATION	
3-1. Each Key and Display .....	3-1
3-2. FUNCTION OF CONTROL KEYS.....	3-2
3-3. MAIN FUNCTIONS .....	3-6
3-4 SPECIAL FUNCTIONS .....	3-8
4. ALIGNMENT AND ADJUSTMENTS	
4-1. GENERAL ERROR FUNCTION.....	4-1
4-2. TEST MODE .....	4-2
5. ASSEMBLY AND DISASSEMBLY	
5-1. TOOLS FOR DISASSEMBLY AND ASSEMBLY .....	5-1
5-2. DISASSEMBLY .....	5-2
5-3. ASSEMBLY .....	5-5
6. TROUBLE SHOOTING	
6-1. TROUBLE DIAGNOSIS .....	6-1
6-2. PROBLEM CHECKING AND METHOD OF PCB .....	6-3
6-3 Control Panel .....	6-4
6-4 Driving Unit.....	6-5
7. EXPLODED VIEWS AND PARTS LIST	
7-1. ASSY-COVER TOP .....	7-1
7-2. ASSY-TUB OUTER(SPIN BASKET) .....	7-2
7-3. ASSY-CASE OUTER.....	7-3
7-4. BOLT/SCREW PARTS LIST .....	7-4

# CONTENTS

---

8. ELECTRICAL PARTS LIST .....	8-1
9. BLOCK DIAGRAM .....	9-1
10. WIRING DIAGRAM .....	10-1
11. PCB DIAGRAM.....	11-1
12. SCHEMATIC-DIAGRAMS .....	12-1
13. CIRCUIT DESCRIPTIONS.....	13-1
14. REFERENCE INFORMATION	
14-1. MODEL NAME .....	14-1
14-2. TERMINOLOGY.....	14-2
14-3. FABRIC CARE CHART .....	14-3
14-4. ELECTRICAL WARNINGS .....	14-4
14-5. Q & A.....	14-5

---

# 1. Precautions

---

## 1-1. Safety Precautions

---

**1. Do not allow the customer to repair the product.**

☞ It may cause personal injury or product damage when the unit is serviced by unqualified personnel.

**2. Disconnect power to the appliance before servicing.**

☞ Be aware of the possibilities of an electric shock.

**3. Do not use multi-plug.**

☞ Power outlet may be overloaded causing the socket to overheat.

**4. Check for any damage on power plug or power outlet.**

☞ Replace it immediately if it has problem. (It may cause an electric shock or fire)

**5. Make sure to earth the product.**

☞ May cause electric shock.

**6. Do not clean the product with water.**

☞ May cause electric shock / fire or shorten product life.

**7. The wiring harness should be free from moisture and connected properly during serving.**

☞ It should be proof against any external force.

**8. Remove any dust or dirt in the product, wiring section and connections during servicing.**

☞ Protect against possibilities of fire due to tracking etc.

**9. Check for any water trace on electrical parts, harness, etc.**

☞ Replace the parts and /or wipe dry the water.

**10. Check the assembled status of the parts after servicing.**

☞ Check if the product is assembled in the same status as before servicing.

**11. Be sure not to pull on the power cord but to unplug it by holding the plug.**

☞ Beware of possibility of electric shock or fire when the power cord is damaged.

**12. Unplug the power plug from the outlet when the washing machine is not used.**

☞ Beware of possibility of electric shock or fire while lightning.

**13. Do not use or put flammable materials (including gasoline, alcohol, thinner etc) around the washing machine.**

☞ Flammable materials may spark an explosion or fire.

**14. Do not put a water containing bowl or wet laundry on the washing machine.**

☞ It may cause an electric shock or fire, or shorten the product life when its water penetrates into the washing machine.

**15. Do not install the washing machine in a place where it is exposed to snow or rain etc.**

☞ It may cause an electric shock or fire and shorten the product life.

**16. Do not press control buttons with pointed objects such as pins, needles, etc.**

☞ It may cause an electric shock or other problems.

**17. Check the washing machine is leveled horizontally on the floor and is installed properly.**

☞ Vibration may shorten the product life.

**18. Make sure to use connectors when connecting wires.**

☞ If wires are connected without connectors, it may cause a tracking fire.

**19. When the washing machine is to be laid down for servicing, put a pad on the floor and lay the product on its side slowly.**

☞ If the wash machine is laid on its front, internal components may be damaged by the tub.



## 1-2. Precautions upon Installation

### ■ How to Remove Shipping Bolts

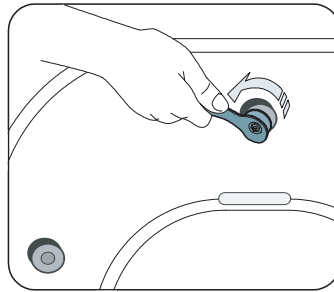
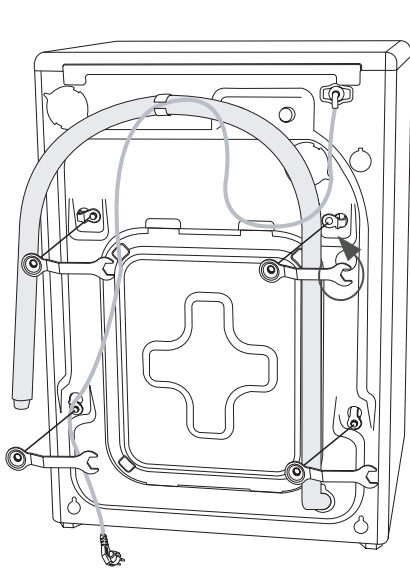

1. Remove the screws by using the supplied spanner.

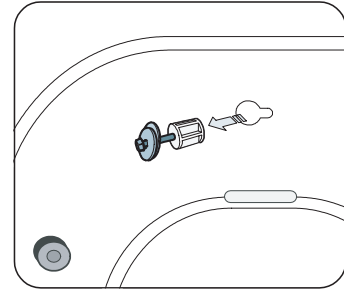

2. Remove the shipping bolts from the back of the unit.

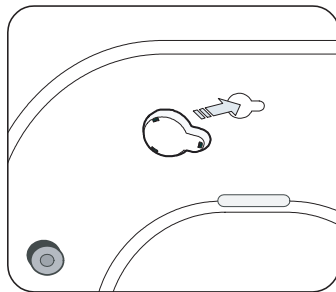

3. Fill the holes with the supplied plastic caps.

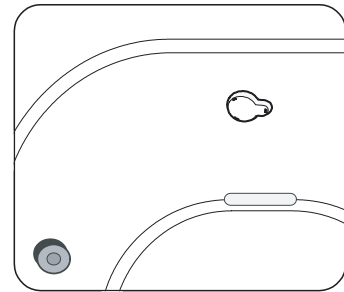

4. Keep the shipping bolts and screws for future use.

### ■ Precautions before Installation

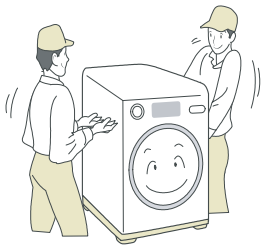

The unit is quite heavy. So, make sure to have 2 or more personnel move it.

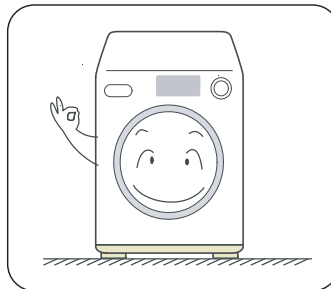

Make sure that the unit stands on a firm and leveled floor.



Keep it away from direct sunlight or high humidity, and install it in a place with good ventilation.

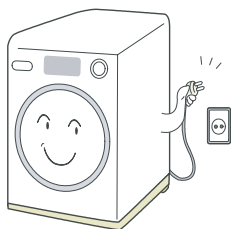

Install the unit at a place with a wall outlet easily accessible.



Keep the unit away from places in which it is freezing, especially in winter.

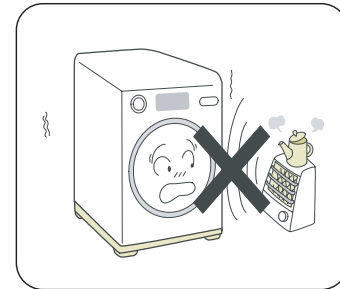

Keep the unit away from heat appliances such as a heater.

## 1-2. Precautions upon Installation

### ■ Grounding

- ▶ Make sure to ground the unit to prevent electric leakage or shock.

#### With a grounded receptacle

- ▶ It does not need an additional grounding.

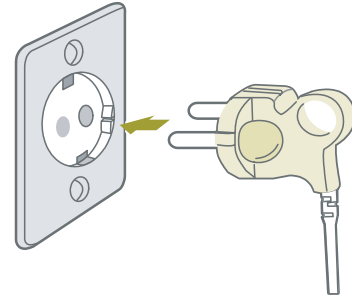

### ■ Water Drainage

- ▶ Hook the drain hose over the Wash Basin or Laundry Tub or plug the end of the drain hose into the Standpipe
- Hook the drain hose over the Wash Basin or Laundry Tub or plug the end of the drain hose into the Standpipe
- The outlet end of the drain hose must be at least 60-90 cm above the base of the machine.



- ▶ Seal the drain pipe connections
- If not, it may cause water leakage.

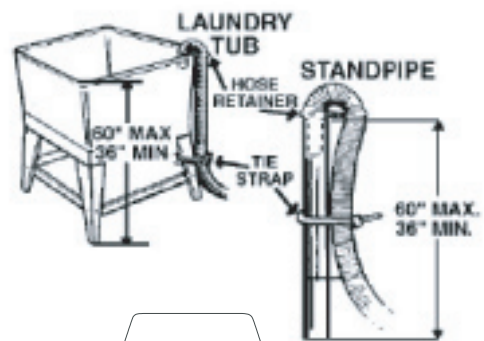

- ▶ Prevent water from siphoning away
- If the end of the drain hose is put in water, it could siphon away water during washing.  
So, make sure that the end of the drain hose is not put in water.

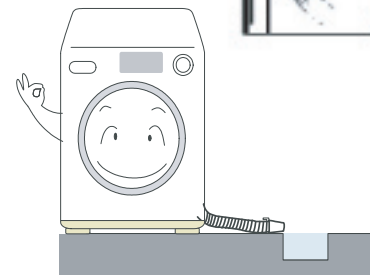

Note: Caution must always be exercised to avoid collapsing or damaging the drain hose.

For best performance the drain hose should not be restricted in any way, through elbows, couplings or excessive lengths.

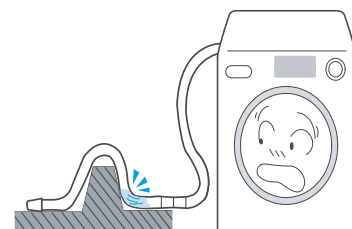
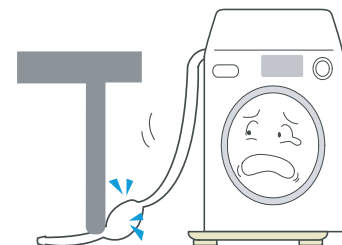

## 1-2. Precautions upon Installation

### ■ How to Level the Unit

1. Select an installation place.

- ▶ Install the unit with 10cm or more clearance from its surrounding walls.

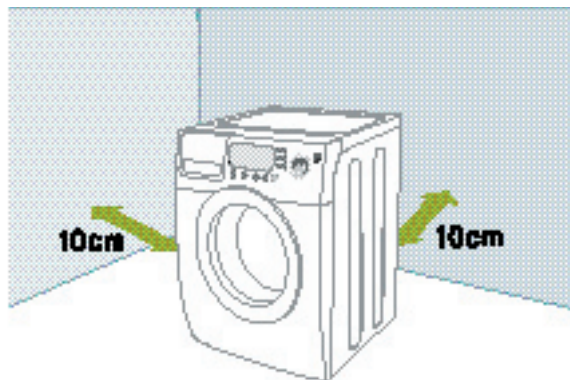

2. Check if the unit is leveled.

- ▶ If the unit wobbles, adjust the leveling legs.



3. Adjust the leveling legs.

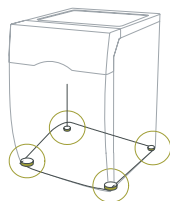

- ▶ The 4 leveling legs should touch the floor all together.

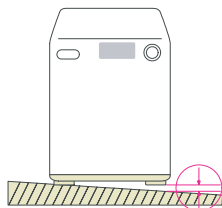

### When the unit is not leveled

- ▶ Lift up the unit a little bit and adjust the shortest.
- ▶ Turn the leveling bolt counter clockwise as shown in the picture above (The leveling leg gets longer.)

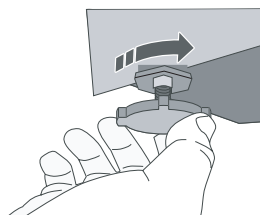

- ▶ Slide your Washer into position.

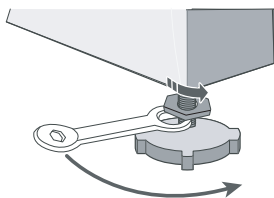

- ▶ Level your Washer by turning the leveling legs in or out as necessary by hand. When your Washer is level, tighten the nuts using the wrench included with your Washer.

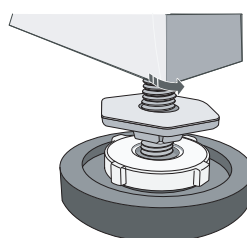

#### ※ CAUTION ※

Tighten the lock nut after the leveling.  
If not, it could generate vibrations & noises.

- ▶ If you install your washer on soft floor, you should place the rubber cup under adjustable leg. Before put rubber cup, please remove film for double-side tape attached on rubber cup.

## 2. PRODUCT SPECIFICATIONS

### 2-1. SPECIFICATIONS OF PRODUCT

TYPE	FRONT LOADING WASHER			
DIMENSION	Div	Inches (cm)	Div	Inches (cm)
	A. Height-Overall	38 (96.5)	C. Depth With Door Open 90°	49 (124.5)
	B. Width	27 (68.6)	D. Depth	30.25 (77.0)
WATER PRESSURE			50 kPa ~ 800 kPa	
WEIGHT			89.9 kg	
CAPACITY			3.29 Cu.ft	
POWER CONSUMPTION	WASHING		120V	226W
	WASHING AND HEATING		120V	997W
	SPIN		120V	379W
	DRAIN		120V	41W
SPIN REVOLUTION	WF326 *		1200rpm	
	WF316*		1100rpm	
	WF306 *		1000rpm	

---

## 2-2. OVERVIEW OF THE WASHING MACHINE

---

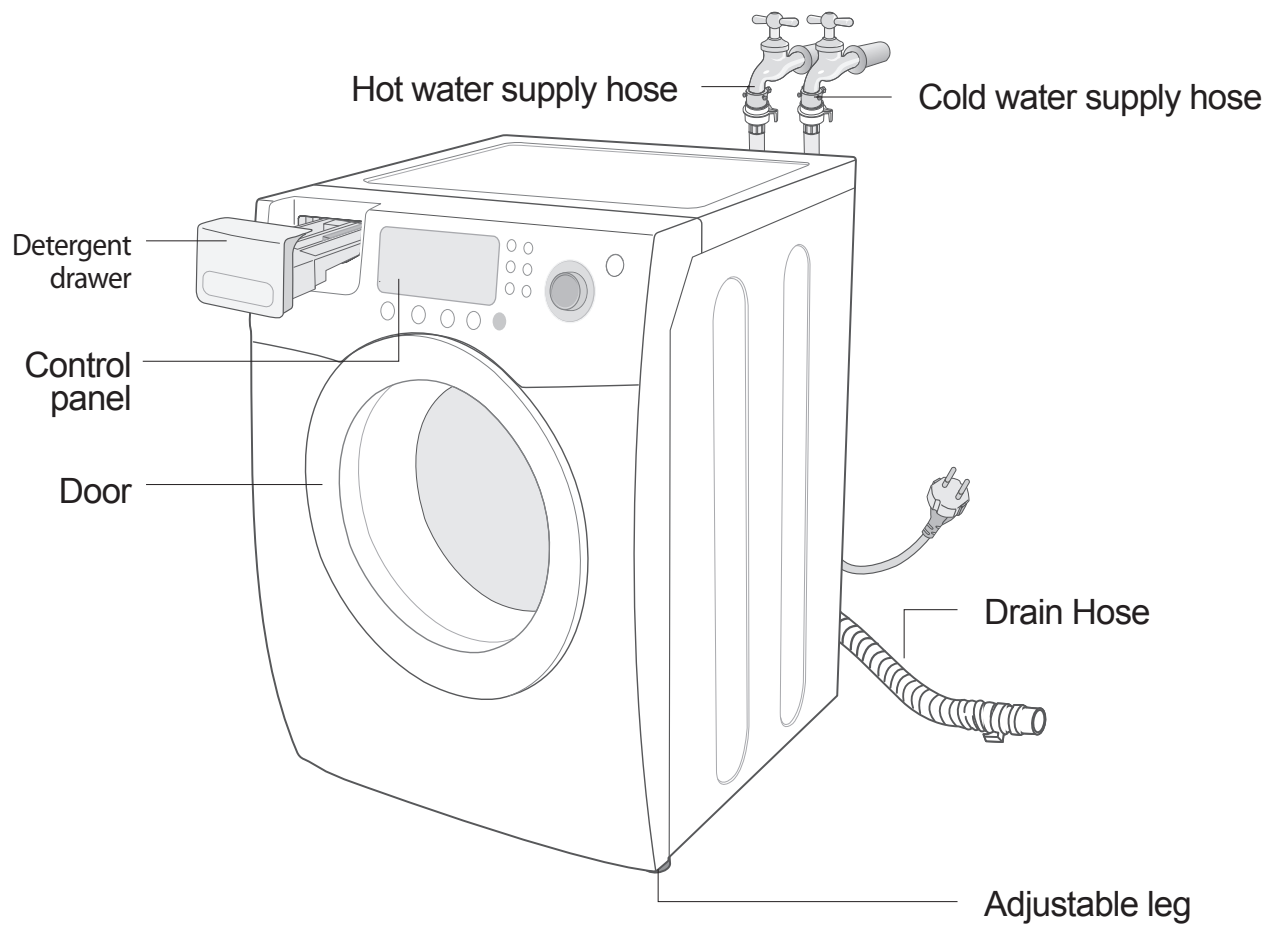

---

## 2-3. THE COMPARATIVE SPECIFICATIONS OF PRODUCT

---

Item	Samsung (WF316LAW)	Whirlpool (GHW9250M)	LG (WM2432HW)	Bosch (WFMC6400)
Capacity (Cu.ft)	3.29 (DOE)	3.21 (DOE)	3.22 (3.72)	2.93 (DOE)
Volume of Spinner (ℓ)	93.4	90	91	83
Motor	Direct Drive	3-Phase	Direct Drive	3-Phase
User Interface	LED	LED	LED	LCD (red)
Cycle Time	57	52	59	66
Wash Performance	1.01	1.00	0.99	1.02
Water Consumption/Cycle	48 Liter	56 Liter	49 Liter	61 Liter
Energy Consumption (W/O Heater Wh/Cycle)	128	105	114	189
RPM	1,100	1,100	1,200	1,200
Noise	57 dB	59 dB	66 dB	62 dB

---

## 2-4. OPTION SPECIFICATIONS

---

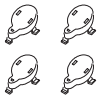
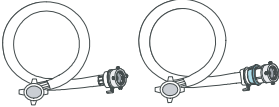
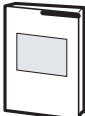
Item	Item Name	CODE.NO	Remark
	SPANNER	DC60-4014 6A	
	HOLE COVER	DC61-10688A	
	HOSE DRAIN	DC97-07126A for HOT DC97-07127A for COLD	
	MANUAL-BOOK	DC68-02291A	

---

## **Memo**

---



### 3. OPERATING INSTALLATION AND INSTALLATION

#### 3-1. OVERVIEW OF THE CONTROL PANEL

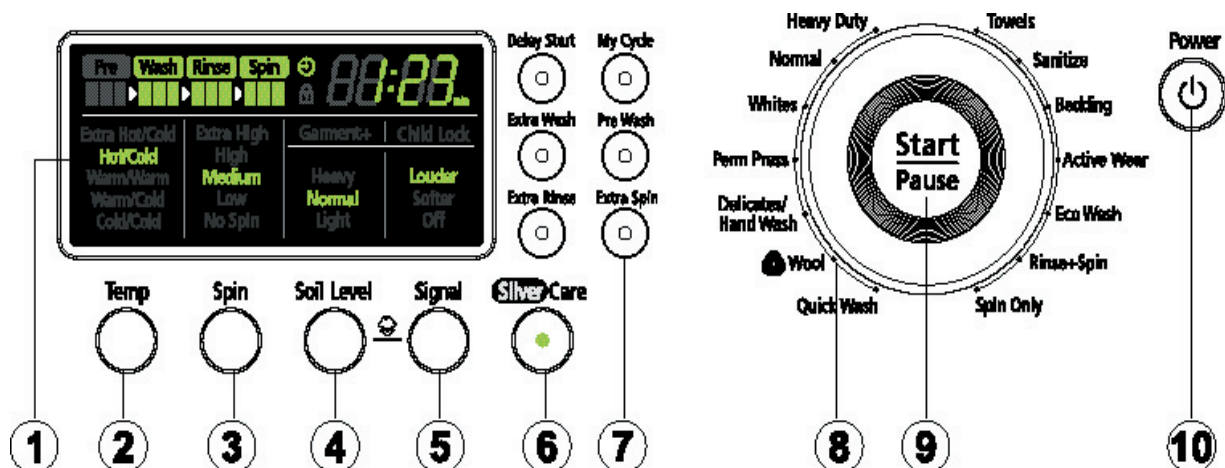

1. Digital graphic display  
Displays the remaining wash time, all wash information, and error messages.
2. Temperature selection button  
Press the button repeatedly to cycle through the different water temperature options.  
**Extra Hot/Cold** - Heavily soiled, colorfast items. Only available with the Sanitize cycle.  
**Hot/Cold** - Whites and heavily soiled, colorfast items.  
**Warm/Warm** - Colorfast items. When warm rinse is selected, only the final rinse will be warm. The other rinses will be cold to conserve energy.  
**Warm/Cold** - Moderately soiled, colorfast items; most wrinkle-free items.  
**Cold/Cold** - Brightly colored, very lightly soiled items; washable woolsens.
3. Spin selection button  
Press the button repeatedly to cycle through the different spin speed options.  
**Extra High** - Removes more water from loads during spin.  
NOTE: To minimize wrinkling of wrinkle-free and no-iron fabrics, DO NOT use the Extra High spin option for these loads, nor overload your Washer.  
**High** - Use for underwear, t-shirts, jeans and sturdy cottons.  
**Medium** - Use for jeans, wrinkle-free or wash-and-wear items and synthetics.  
**Low** - Use for delicate items needing a slow spin speed because of fabric and construction.  
**No Spin** - Drains your Washer without spinning. Use for extremely delicate items that cannot tolerate any spin.
4. Soil Level selection button  
Press the button to select the Soil Level/washing time.  
**Heavy** - For heavily soiled loads.  
**Normal** - For moderately soiled loads. This setting will be appropriate for most loads.  
**Light** - For lightly soiled loads.
5. Signal selection button  
Press the button to increase or decrease the end of cycle signal volume or turn off the signal.
6. SilverCare button  
Silver ions are added during the wash and rinse cycles to maximize the sanitizing and antibiotic effects.

---

## 3-1. OVERVIEW OF THE CONTROL PANEL

---

### 7. Select Cycle Option

**Delay Start** - Any cycle can be delayed for up to 12, 19 or 24 hours (select models) in one-hour increments. Displayed hour indicates the time at which the wash will be finished.

**Extra Wash** - Add additional time to the wash for better stain removal.

**Extra Rinse** - Add an additional rinse at the end of the cycle to more thoroughly remove laundry additives and perfumes.

**Extra Spin** - Add additional time to remove more water from loads

**My Cycle** - Choose your favorite cycle including temperature, spin, soil level, option, etc.

**Pre Wash** - Add detergent to the Pre Wash selection of the detergent compartment. Washer fills with cold water and detergent, tumbles, then drains and advances to the selected wash cycle. Some cycles cannot be selected with this option.\*

\* You can't select PreWash option in Delicate/Hand Wash, Wool, Quick Wash and Active Wear cycles.

### 8. Cycle Selector

Select the appropriate cycle for the type of load.

This will determine the tumble pattern and spin speed for the cycle.

NOTE: To minimize wrinkling of loads, select the Perm Press cycle.

**Heavy Duty** - For sturdy, colorfast fabrics and heavily soiled garments.

**Normal** - For most fabrics including cottons, linens, and normally soiled garments.

**Whites** - For white fabrics with or without bleach.

**Perm Press** - For wash-and-wear, synthetic fabrics, and lightly to normally soiled garments.

**Delicates/Hand Wash** - For sheer fabrics, bras, lingerie silk, and other handwash-only fabrics. For best results, use liquid detergent.

**Wool** - For machine-washable wool. Loads should be under 8 pounds.



The wool wash cycle of this machine has been approved by Woolmark for the washing of machine washable Woolmark products provided that the products are washed according to the instructions on the garment label and those issued by the manufacturer of this washing machine, M0509.

**Quick Wash** - For lightly soiled or wrinkled garments needed quickly.

**Towels** - For bath towels and washcloths. Do not load too many towels because they absorb lots of water.

**Sanitize** - For heavily soiled, colorfast garments. This cycle heats the water to 150°F to eliminate bacteria.

NOTE: If Pause is selected during the heating portion of the Sanitize Cycle, your Washer door will remain locked for your safety.

**Bedding** - For bulky items such as blankets and sheets.

**Active Wear** - For washable sportswear.

**Eco Wash** - For geographic areas where energy and water conservation is needed.

**Rinse + Spin** - Use for loads that need rinsing only or to add rinse-added fabric softener to a load.

**Spin Only** - Provides a spin to remove more water from the load.

### 9. Start/Pause selection button

Press to pause and restart programs.

### 10. Power button

Press once to turn your Washer on, press again to turn your Washer off. If your Washer is left on for more than 10 minutes without any buttons being touched, the power automatically turns off.

NOTE: Cycles and options vary by model. Refer to cycle chart in Appendix.

### 3-2. PROGRAMME CHART

326LAW, 326LAS

	Functions													Options						Time		
	Temp					Spin					Soil Level			Delay Start	Extra Wash	Extra Rinse	My Cycle	Pre Wash	Extra Spin		Silver Care	
	EH/C	H/C	W/W	W/C	C/C	EH	H	M	L	NS	H	N	L									
Heavy Duty		√	√	√	√	√	√	√	√	√	√	√	√	√	√	√	√	√	√	√	√	90
Normal		√	√	√	√	√	√	√	√	√	√	√	√	√	√	√	√	√	√	√	√	53
Whites		√	√	√	√	√	√	√	√	√	√	√	√	√	√	√	√	√	√	√	√	60
Perm Press			√	√	√		√	√	√	√	√	√	√	√	√	√	√	√	√	√	√	45
Delicates/Hand Wash			√	√	√				√	√	√	√	√	√	√	√	√					39
Wool					√				√	√		√		√		√						57
Quick Wash		√	√	√	√	√	√	√	√	√	√	√	√	√	√	√	√					33
Towels		√	√	√	√	√	√	√	√	√	√	√	√	√	√	√	√	√	√	√	√	64
Sanitize	√					√	√	√	√	√	√	√	√	√	√	√	√	√	√	√	√	110
Bedding			√	√	√			√	√	√	√	√	√	√	√	√	√	√	√	√	√	69
Active Wear			√	√	√		√	√	√	√	√	√	√	√	√	√	√					49
Eco Wash		√	√	√	√	√	√	√	√	√	√	√	√	√	√	√	√	√	√	√	√	45
Rinse + Spin					√	√	√	√	√	√				√		√	√			√	√	18
Spin Only						√	√	√	√	√				√			√					9

306LAW

	Functions											Options				Time		
	Temp				Spin				Soil Level			Delay Start	Extra Wash	Extra Rinse	Silver Care			
	H/C	W/W	W/C	C/C	H	M	L	NS	H	N	L							
Heavy Duty	√	√	√	√	√	√	√	√	√	√	√	√	√	√	√	√	√	65
Normal	√	√	√	√	√	√	√	√	√	√	√	√	√	√	√	√	√	53
Whites	√	√	√	√	√	√	√	√	√	√	√	√	√	√	√	√	√	60
Perm Press		√	√	√	√	√	√	√	√	√	√	√	√	√	√	√	√	45
Delicates/Hand Wash		√	√	√			√	√	√	√	√	√	√	√		√	√	39
Wool				√			√	√		√		√		√				57
Quick Wash	√	√	√	√	√	√	√	√	√	√	√	√	√	√		√	√	33
Towels	√	√	√	√	√	√	√	√	√	√	√	√	√	√	√	√	√	64
Rinse + Spin				√	√	√	√	√	√				√			√	√	18

### 3-2. PROGRAMME CHART

316LAW, 316BAW, 316BAC

	Functions													Options					Time	
	Temp					Spin					Soil Level			Delay Start	Extra Wash	Extra Rinse	My Cycle	Pre Wash		Silver Care
	EH/C	H/C	W/W	W/C	C/C	EH	H	M	L	NS	H	N	L							
<b>Heavy Duty</b>		√	√	√	√	√	√	√	√	√	√	√	√	√	√	√	√	√	√	90
<b>Normal</b>		√	√	√	√	√	√	√	√	√	√	√	√	√	√	√	√	√	√	53
<b>Whites</b>		√	√	√	√	√	√	√	√	√	√	√	√	√	√	√	√	√	√	60
<b>Perm Press</b>			√	√	√		√	√	√	√	√	√	√	√	√	√	√	√	√	45
<b>Delica-tes/ Hand Wash</b>			√	√	√				√	√	√	√	√	√	√	√	√	√	√	39
<b>Wool</b>					√				√	√		√		√		√				57
<b>Quick Wash</b>		√	√	√	√	√	√	√	√	√	√	√	√	√	√	√	√	√	√	33
<b>Towels</b>		√	√	√	√	√	√	√	√	√	√	√	√	√	√	√	√	√	√	64
<b>Sani-tize</b>	√					√	√	√	√	√	√	√	√	√	√	√	√	√	√	110
<b>Bed-ding</b>			√	√	√			√	√	√	√	√	√	√	√	√	√	√	√	69
<b>Rinse + Spin</b>					√	√	√	√	√					√		√			√	18
<b>Spin Only</b>						√	√	√	√	√				√						9

306BHW

	Functions												Options				Time			
	Temp					Spin					Soil Level			Delay Start	Extra Wash	Extra Rinse		Silver Care		
	EH/C	H/C	W/W	W/C	C/C	H	M	L	NS	H	N	L								
<b>Heavy Duty</b>		√	√	√	√	√	√	√	√	√	√	√	√	√	√	√	√	√	√	65
<b>Normal</b>		√	√	√	√	√	√	√	√	√	√	√	√	√	√	√	√	√	√	53
<b>Whites</b>		√	√	√	√	√	√	√	√	√	√	√	√	√	√	√	√	√	√	60
<b>Perm Press</b>			√	√	√	√	√	√	√	√	√	√	√	√	√	√	√	√	√	45
<b>Delicates/ Hand Wash</b>			√	√	√			√	√	√	√	√	√	√	√	√	√	√	√	39
<b>Wool</b>					√			√	√		√		√		√					57
<b>Quick Wash</b>		√	√	√	√	√	√	√	√	√	√	√	√	√	√	√	√	√	√	33
<b>Towels</b>		√	√	√	√	√	√	√	√	√	√	√	√	√	√	√	√	√	√	64
<b>Sanitize</b>	√					√	√	√	√	√	√	√	√	√	√	√	√	√	√	110
<b>Bedding</b>			√	√	√		√	√	√	√	√	√	√	√	√	√	√	√	√	69
<b>Rinse + Spin</b>					√	√	√	√	√					√		√			√	18
<b>Spin Only</b>						√	√	√	√					√						9

---

## 3-3. MAIN FUNCTION

---

### CHILD LOCK

A function that prevents children from playing with your Washer.

If you want to activate/deactivate the Child Lock function, press the **Soil Level** and **Signal** buttons at the same time for 3 seconds.

#### How It Works:

1. Child Lock can be activated while your Washer is running.
2. Once you activate Child Lock, all controls (except for the Power button) will be locked until you deactivate Child Lock.
3. The Child Lock button will be lit while it is in effect.  
**Note:** When buttons, other than the Power button, do not respond, please check if the Child Lock button is on.

### GARMENT +

You can add or take laundry items even after the wash has started, as long as the Garment+ light is on. Pushing the Start/Pause button unlocks the door, unless the water is too hot or if there is too much water in your Washer. If you are able to unlock the door and wish to continue the wash cycle, close the door and press the Start/Pause button.

### MY CYCLE

Allows you to activate your custom wash (temperature, spin, soil level, etc.) with one-button convenience.

By pushing the My Cycle button, you activate the settings used during the last My Cycle mode. The My Cycle light will indicate activation.

#### You can select all options as follows in My Cycle mode.

1. Select cycle using Cycle Selector dial.
2. After cycle selection, set each option.  
**Note:** At this time, the option will follow as per each cycle's default option selection.

Then you can start My Cycle by pushing the Start/Pause button in My Cycle mode.

The cycle and options you select will be displayed next time you choose My Cycle.

---

### 3-3. MAIN FUNCTION

---

#### FOR SILVERCARE WASHING

Silver ions are added during the wash and rinse cycles to maximize the sanitizing and antibiotic effects, treating fabrics with a microscopic coating protection that kills more than 650 kinds of bacteria.

1. Open the door, put in the clothes and close the door again.
2. Press the Power button.
3. Select a Cycle by turning the Cycle Selection dial.
4. Press SilverCare button.
5. Add detergent in the dispenser tray for main washing, and add fabric softener up to the marked line.
  - : For Pre Wash, put a supplementary detergent in the dispenser.
  - SilverCare: If it is used together with fabric softener, its effect may be decreased.
6. Press Start/Pause button.
  - : Automatically selects optimal washing conditions by sensing the laundry's weight.

**Note:**

FOR HOME USE ONLY– COMMERCIAL USERS SHOULD NOTIFY THEIR LOCAL WASTE TREATMENT AUTHORITIES BEFORE USE

You can find # of times you used SilverCare option by pushing signal and SilverCare button.

LU3 :less than 1000 times

LU2 :between 1000 to 2000 times

LU1 :between 2000 to 2999 times

LU0 :over 2999 times

You should replace the silver kit when it display "LU0". Contact 1-800-SAMSUNG.

**Note:**

For some model which has no heater if you choose SilverCare, Temp will be fixed to Cold/Cold. If you change Temp selection, SilverCare will be canceled.

### 3-4. TECHNICAL POINT

#### 1) Motor on/off time at each course

unit:sec

Course	Washing				Motor r.p.m
	Cw	Off	Ccw	Off	
Heavy Duty	13	4	13	4	52
Normal	12	8	12	8	50
Whites	7	8	7	8	40
Perm Press	5	10	5	10	40
Delicate/Hand wash	2	48	2	48	50
Wool	2	58	2	58	50
Quick Wash	12	8	12	8	50
Towels	10	10	10	10	50
Sanitize	8	12	8	12	45
Bedding	10	10	10	10	45
Rinse + Spin	5	10	5	10	40

#### 2) Final dehydrating r.p.m at each course

unit:rpm

Course	Model
	<b>WF316L</b>
Heavy Duty	1200
Normal	1200
Whites	1200
Perm Press	800
Delicate/Hand wash	800
Wool	400
Quick Wash	1200
Towels	400
Sanitize	1200
Bedding	1200
Rinse + Spin	800
Spin Only	1200

### 3-4. TECHNICAL POINT

#### 3) The water supply control at each process cycle

Process cycle	Model	WF316, WF306
Pre Washing		Cold water 5L/min
Washing		Cold water 10L/min + (Hot water 10L/min)
Rinse		Cold water 10L/min
Final rinse		Cold water 10L/min + Cold water 5L/min

#### 4) The water level data at each course

unit:Khz

Course	Model	Default water level (kHz)	Supplementary water START (kHz)	Supplementary water End (kHz)
Heavy Duty	Washing	24.25	24.90	23.60
	Rinse	23.60	25.00	24.60
Normal	Washing	24.25	24.90	23.60
	Rinse	23.60	25.00	24.60
Whites	Washing	24.40	25.00	24.75
	Rinse	23.60	25.00	24.60
Perm Press	Washing	23.80	24.55	24.30
	Rinse	23.65	24.55	24.30
Delicate/Hand wash	Washing	23.45	24.35	24.00
	Rinse	23.15	24.35	24.00
Wool	Washing	24.40	25.00	24.70
	Rinse	23.80	25.00	24.70
Quick Wash	Washing	24.25	24.90	23.60
	Rinse	23.50	25.00	24.60
Towels	Washing	24.25	24.90	24.60
	Rinse	23.50	25.00	24.60
Sanitize	Washing	24.25	24.90	24.60
	Rinse	23.50	25.00	24.60
Bedding	Washing	24.25	24.90	24.60
	Rinse	23.50	25.00	24.60
Rinse + Spin	Washing	24.25	24.90	24.60
	Rinse	23.50	25.00	24.60



---

## **Memo**

---

## 4. ALIGNMENT AND ADJUSTMENTS

### 4-1. GENERAL ERROR FUNCTION

NO	LED Display	Diagnostic Code	Description	Corrective Action
1	nd	1	The water level fails to drop below the Reset Water Level within 15 minutes.	Go to "Will Not Drain" Troubleshooting Section.
2	LO	2	Door fails to unlock after 3 attempts.	Go to "Will Not Unlock" Troubleshooting Section.
3	nF	3	When the filling continues for more than 16 minutes or there is no change of water level for 3 minutes	Go to "No Water Fill" Troubleshooting Section.
4	FL	4	Door fails to lock after 3 attempts.	Go to "Will Not Lock" Troubleshooting Section.
5	LE	8	Water Level Sensor Trouble. (When the input signal from the water level sensor is out of range, the unit will send out beeping sounds and halts the cycle.)	Go to "No Water Fill" Troubleshooting Section.
6	OE	E	A fault is detected in the water level sensor. Data (frequency) shows the water level is at or above the overflow water level. (When this condition is detected, the machine will automatically starts draining water until the water level falls below the overflow water level)	First check to see that all of water valves are not stuck. If water valves are OK, check water level sensor.
7	dc	10	Unbalance or cabinet bump is detected during final spin, which prevents the drum from spinning over 400 rpm. (Never exceeds 400 RPM due to unbalanced load)	Go to "Wet Clothes" Troubleshooting Section.
8	-	11	EEPROM Fault. (Program settings are being reset.)	Go to "EEPROM Clear Mode" If display shows "FAiL", Replace Machine Control Board.
9	E2	15	Jammed Key. (When key input signals are coming out for more than 30 seconds, it is regarded as a jam.)	Check all of keys. If a key is sensed to be pressed, all keys will do not respond.
10	dL	18	Door is detected as open when the motor is operating.	Check for loose wire connections. Go to "Quick Test Mode" and then do Door lock/Unlock Test and Motor Test.
11	dS	22	Door is detected as open while it is trying to lock the door.	Go to "Quick Test Mode" and then do Door Lock/Unlock Test
12	bE	25	Motor hall sensor signals come out without motor operation.	Replace Machine Control Board.
13	tE	29	Abnormal high/low temperature or resistance (Thermal sensor or PBA) resistance.	Go to "Board Input Test" and check Water Temperature. Check loose or pinched wires. Replace PCB or thermistor.
14	E3	2E	MICOM is attempting to drive the motor but is not getting any response signals from the hall sensor. Visual check shows motor is not running. (Locked, Defective Hall Sensor or Overload)	Evaluate wire harness for loose or unhooked connections. Go to "Quick Test Mode" and test Motor.
15	Sr	34	System Relay (Main Relay) Failure. (PCB does not notice the relay operation when there should be.)	Replace PCB.
16	Hr	36	Heater Relay Failure (No Heater Relay Check Signal)	Replace PCB
17	3E	3E	Over-current is detected. Motor won't turn. (IPM detects over-current.)	Evaluate wire harness for loose or unhooked connections. Go to "Quick Test Mode" to test Motor.
18	2E	91	Voltage for motor control bus is over specified limit.	Replace PCB
19	2E	92	Voltage for motor control bus is under specified limit.	Replace PCB
20	8E	8E	MEMS Sensor Failure. (No MEMS Sensor Check Signal)	Check MEMS PCB ,Main PCB & Wire-harness
21	7E	7E	Silver Care Kit (Silver Care PCB) Failure.	Check Silver Care PCB ,Main PCB & Wire-harness
22	PF	-	It occurs when there is power failure during the washing. ("PF" is not an error. It is to inform the user of power failure.)	-
23	SUdS	-	Suds is detected during the washing session. ("SUdS" is not an error. If the washer is in suds period, "SUdS" will light up instead of remaining time.)	Guide a user to reduce amount of detergent usage.

## 4-2. TEST MODE

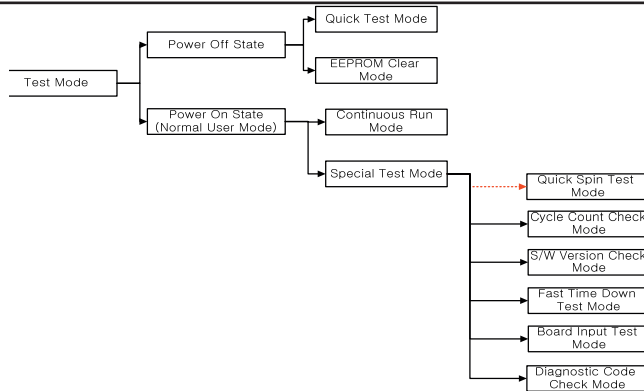

### Test Mode

Each Test Mode for the Frontier Washer is as follows in the coming pages. The test modes indicated by the red arrows are the modes unable to get an access once the washing cycle has started due to safety reasons.

### 4-2-1. Quick Test Mode

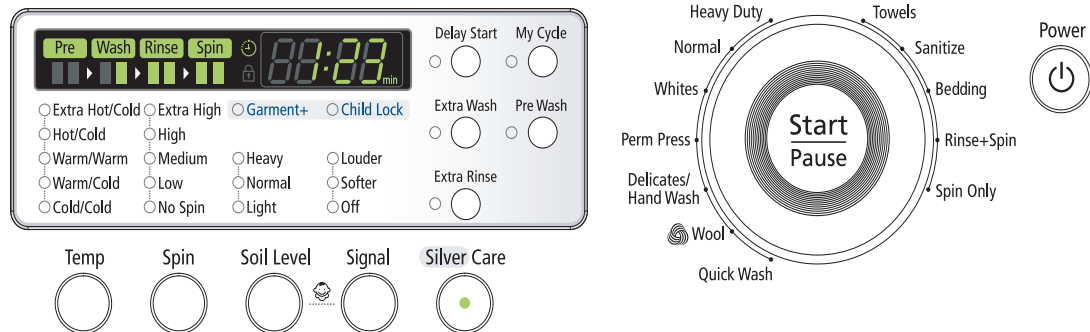

#### Definition of Quick Test Mode:

- Check operation of all LED's (Verify faulty LED).
- Check model and software version.
- Check different operating modes (e.g. water valve, motor, door, drain pump, etc.).

#### How to Enter:

- Plug in and turn on the unit.
- Press Spin Key, Soil Level Key and Power Key at the same time.  
(Same for all Frontier models.)

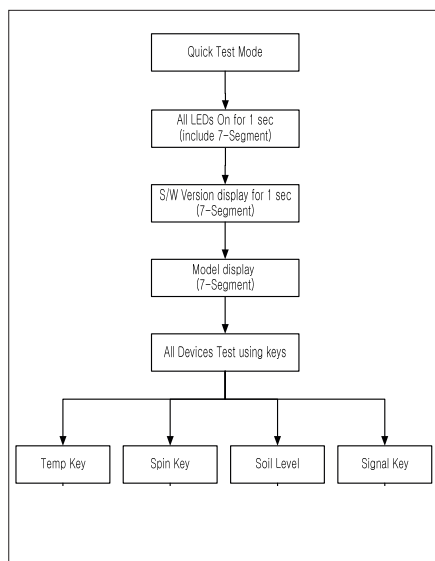

#### Quick Test Mode:

1. All LED's light up and it sends out Beep Sound when it enters into the Quick Test Mode. (Including 7-Segment)
2. Displays software version for a sec.  
(Ex. If S/W Version is 60, 7-Segment will display U060)
3. After displaying the software version, 7-Segment will display the following information for each model.
  - F1 : WF326LAW, WF326LAS
  - F2 : WF316LAW
  - F2b: WF316BAC, WF316BAW
  - F3 : WF306LAW
  - F8b: WF306BHW
  - EEEE : Model option Error (Need to replace PCB Assy.)
4. When model information is being displayed, press the following keys to test various components.
  - Temp Key : Water Valve Test
  - Spin Key : Motor Test
  - Soil Level Key : Door Lock/Unlock Test
  - Signal Key : Drain Pump Test.

## 4-2-1. Quick Test Mode

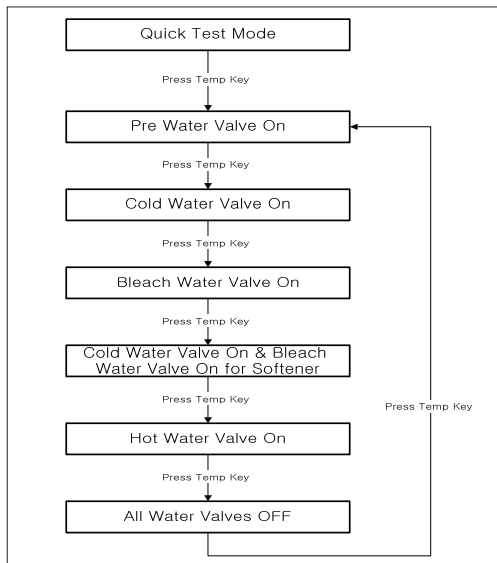

### Water Valve Test:

1. To enter the Water Valve Test, press the Temp Key while model information is being displayed during the Quick Test Mode.
2. Each time the Temp Key is pressed, it will cycle through the operations on the left flow chart. But, WF306LAW(F3) and WF306BHW(F8b) do not have the pre water valve. So, it will skip Pre Water Valve On and jump to Cold Water Valve On.
3. If the Temp Key is pressed during All Water Valve OFF, the machine will return to the beginning as shown in the flow chart.
4. The door needs to be secured for the Water Valve to operate. Therefore, the door lock will be on during the water valve operation.
5. If there is any problem with Water Valve, PCB Assy. or Wire Harness, the water valves could not operate. So, to make sure for the water valves to operate, check visually if water comes out with each Water Valve On mode.

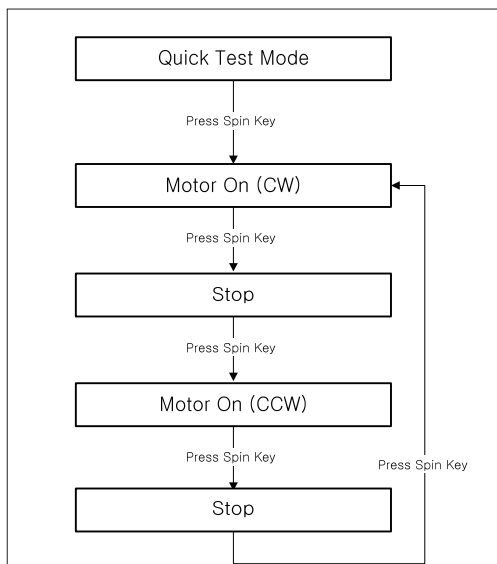

### Motor Test:

1. To enter the Motor Test, press the Spin Key while model information is being displayed during the Quick Test Mode.
2. Each time the Spin Key is pressed, it will cycle through the operations on the left flow chart.
4. The Door Lock will be on during the motor operation.
5. If there is any problem with Motor, PCB Assy. or Wire Harness, related error codes will be displayed.

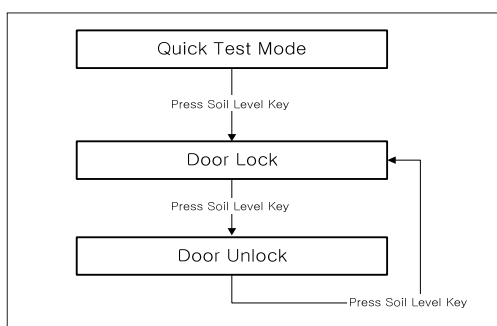

### Door Lock/Unlock Test:

1. To check the Door Lock/Unlock operation, press the Soil Level Key while model information is being displayed during the Quick Test Mode.
2. Each time the Soil Level Key is pressed, it will cycle through the Door Lock/Unlock operations on the left flow chart.
3. If the Soil Level Key is pressed during Door Lock and Water Valve, Motor or Drain Pump operation, all of the operations will stop. And, when the Soil Level Key is pressed again, the door will be released.
4. If there is any problem with Door Switch, PCB Assy. or Wire Harness, related error codes will be displayed.

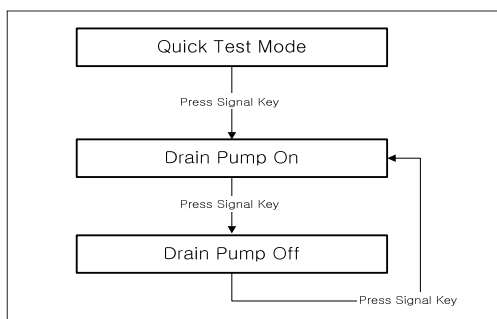

### Drain Pump Test:

1. To check the Drain Pump operation, press the Signal Key while model information is being displayed during the Quick Test Mode.
2. Each time the Signal Key is pressed, it will cycle through the operations on the left flow chart.
3. The Drain Pump operation is independent. Therefore, it will operate regardless of Door Lock/Unlock.
4. If there is any problem with Drain Pump, PCB Assy. or Wire Harness, the Drain Pump will not operate. So, its operation needs a visual inspection.

---

## 4-2-2. EEPROM Reset Mode

---

Definition of EEPROM Reset Mode:

- EEPROM initialization.
- All course/option settings are to be reset to default values after EEPROM initialization.
- When Service arises and it needs PCB replacement, EEPROM should be reset.

How to Enter:

- The unit needs to be on.
- Press Delay Start Key, Signal Key and Power Key at the same time.  
(Same for all Frontier models.)

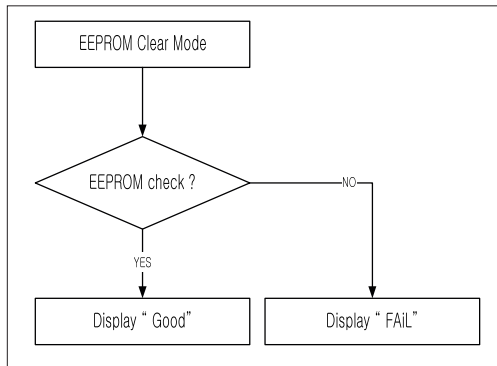

EEPROM Reset Mode:

1. EEPROM can be reset once the user enters the EEPROM Clear Mode.
2. If there is any problem with EEPROM, 7-Segment will display "FAIL". "Good" will be displayed if everything is OK.
3. PCB assy. needs replacing if "FAIL" is displayed during EEPROM reset.
4. If PCB assy. is replaced for some reason, EEPROM needs resetting.
5. If problem occurs with Sticky Function, My Cycle and Power Failure Compensation, it may be due to EEPROM. Check EEPROM's condition at EEPROM Clear Mode.

---

## 4-2-3. Continuous Run Mode

---

Definition of Continuous Run Mode:

- Will continuously repeat the current cycle until the Continuous Run Mode is cancelled.

How to Enter:

- Press Delay Start Key and Extra Rinse Key together for 3 sec.  
(Same for all Frontier models.)

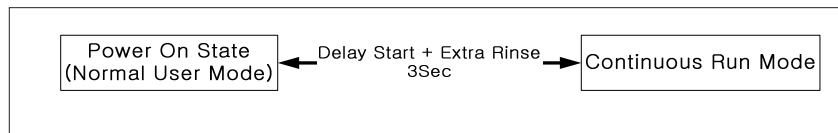

Continuous Run Mode:

1. Press Delay Start + Extra Rinse Key for 3 sec during Power On State (Normal User Mode).
2. Once in Continuous Run Mode, 7-Segment will blink "cc" and the remaining time in turns.
3. The Continuous Run Mode will repeat the previous cycle until continuous run mode is cancelled.
4. During Continuous Run Mode, press Delay Start + Extra Rinse Key for 3 seconds to return to normal user mode. 7-segment will no longer display "cc", but only display the remaining time.

---

## 4-2-4. Special Test Mode

---

Definition of Special Test Mode:

- Special Test Mode enables service technicians to verify the operation of the washing machine and do troubleshooting.
- Special Test Mode can be entered during all washing cycle without interrupting the cycle except some of test modes.
- Various tests can be done with Special Test Mode. So, troubleshooting can be done based on the resulting diagnostic codes.

How to Enter:

- To enter the Special Test Mode, press the Signal and Extra Rinse Keys for 3 seconds or until the unit sends out beeping sounds. (same for all Frontier models.)

## 4-2-4. Special Test Mode

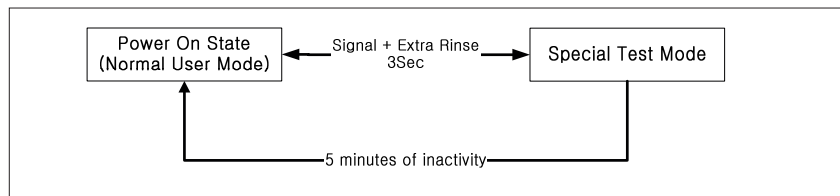

Special Test Mode:

1. The washer must be on to go into the Special Test Mode.
2. The motor speed will be displayed when started (It displays 0 when the motor does not spin).
3. The present state of the machine will not be changed.  
(i.e., the current cycle in progress will not be interrupted and only the display will change)
4. All LED's will be turned off except the "Door Lock" LED. It will continue to display the condition of the door lock.
5. To exit Special Test Mode, press Signal and Extra Rinse Keys for 3 second again, or Power Key.  
If no key is operated during Special Test Mode for 5 minutes, the machine will return to normal user mode.

## 4-2-5. Quick Spin Test Mode

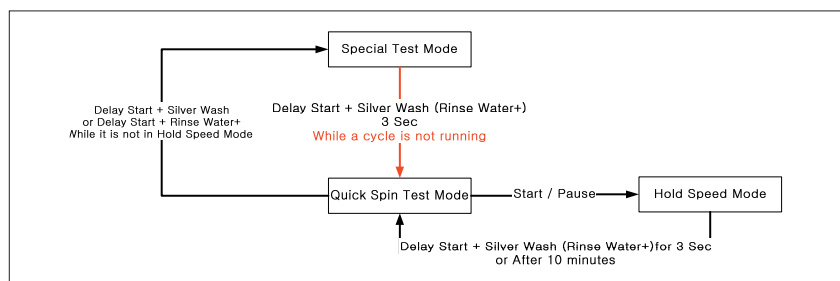

Definition of Quick Spin Test Mode:

- Quick Spin Test Mode is to do Spin Check. (High RPM)

How to Enter:

- During Special Test Mode, press the Delay Start and Silver Wash Keys (Rinse Water + Key) for 3 seconds to enter Quick Spin Test Mode. (same for all Frontier models.)
- Cannot enter once the washing cycle has started.

Quick Spin Test Mode:

As it enters into the Quick Spin Test Mode, it starts spinning and reaches to its maximum RPM. And then, it stays at its maximum speed for 2 minutes before it exits the Quick Spin Test Mode.

To hold Quick Spin Test Mode (entering Speed Hold Mode), press the Start/Pause button. If the Start/Pause button is pressed during Quick Spin Test Mode, it will stop accelerating and hold its spinning speed for 10 minutes before going back to Quick Spin Test Mode.

Also, to cancel the hold and allow Quick Spin Test Mode to continue, press the Delay Start and Silver Wash Keys together for 3 seconds.

## 4-2-6. Cycle Count Check Mode

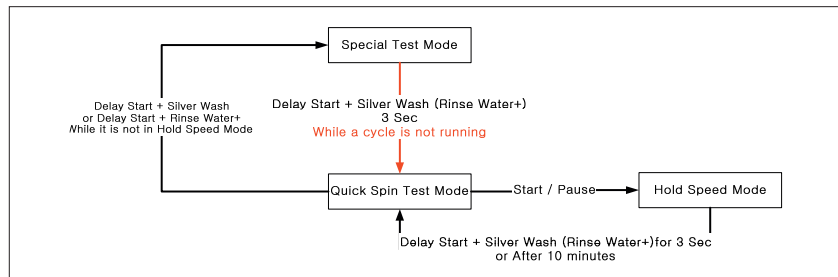

Definition of Cycle Count Check Mode:

- Cycle Count Check Mode is to tally up the number of washings.

How to Enter:

- To enter the Cycle Count Check Mode, press the Signal Key during Special Test Mode.  
(same for all Frontier models.)

Cycle Count Check Mode:

1. Activate the Special Test Mode in advance.
2. When the Signal key is pressed, the total number of washings will light up and a signal LED will glow (Louder, Softer, Off LED).
3. The maximum number of cycles will be 2999.  
The counter will roll over to 0 and start counting again after 2999.
4. The counting will be carried out at the end of the normal cycle.  
(During Continuous Run Mode, it does not Do not count any cycle in Continuous Run Mode)
5. To exit the Cycle Count Check Mode, press the "Signal" key again.  
Then, it returns to the Special Test Mode with motor RPM illuminating.

## 4-2-7. S/W Version Check Mode

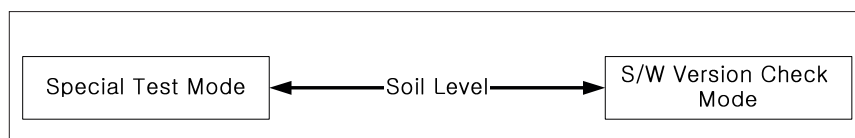

Definition of S/W Version Check Mode:

- S/W Version Check Mode is to bring up S/W Version information.

How to Enter:

- To enter the S/W Version Check Mode, press the Soil Level Key during Special Test Mode.  
(same for all Frontier models.)

S/W Version Check Mode:

1. Activate the Special Test Mode in advance.
2. Press the Soil Level Key to bring up its software Version  
Ex) Generate U005 at U005
3. To exit the S/W Version Check Mode, press the Soil Level S/W once again.  
Then, it returns to the Special Test Mode with motor RPM illuminating.

## 4-2-8. Fast Time Down Test Mode

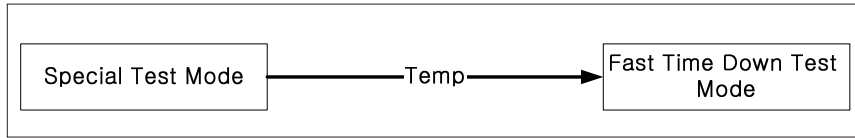

Definition of Fast Time Down Test Mode:

- Fast Time Down Test Mode is to forward the program to the next cycle stage.

How to Enter:

- To enter the Fast Time Down Test Mode, press the Temp key during Special Test Mode. (same for all Frontier models.)

Fast Time Down Test Mode:

1. Activate the Special Test Mode in advance.
2. To forward the program to the next cycle stage, press the Temp key.

Each stage is located at key points of a complete cycle as follows:

- End of Each Fill (Beginning of Wash or Rinse Tumble Session)
- Beginning of Drain Session
- Beginning of Spin Session (Here, it checks the water level. So, if it is over the reset level, it carries out draining before the spinning.)
- Beginning of Fill Session
- Beginning of Bleach Fill
- Beginning of Fabric Softener Fill
- Every 3 minutes during Wash and Rinse Tumble Session

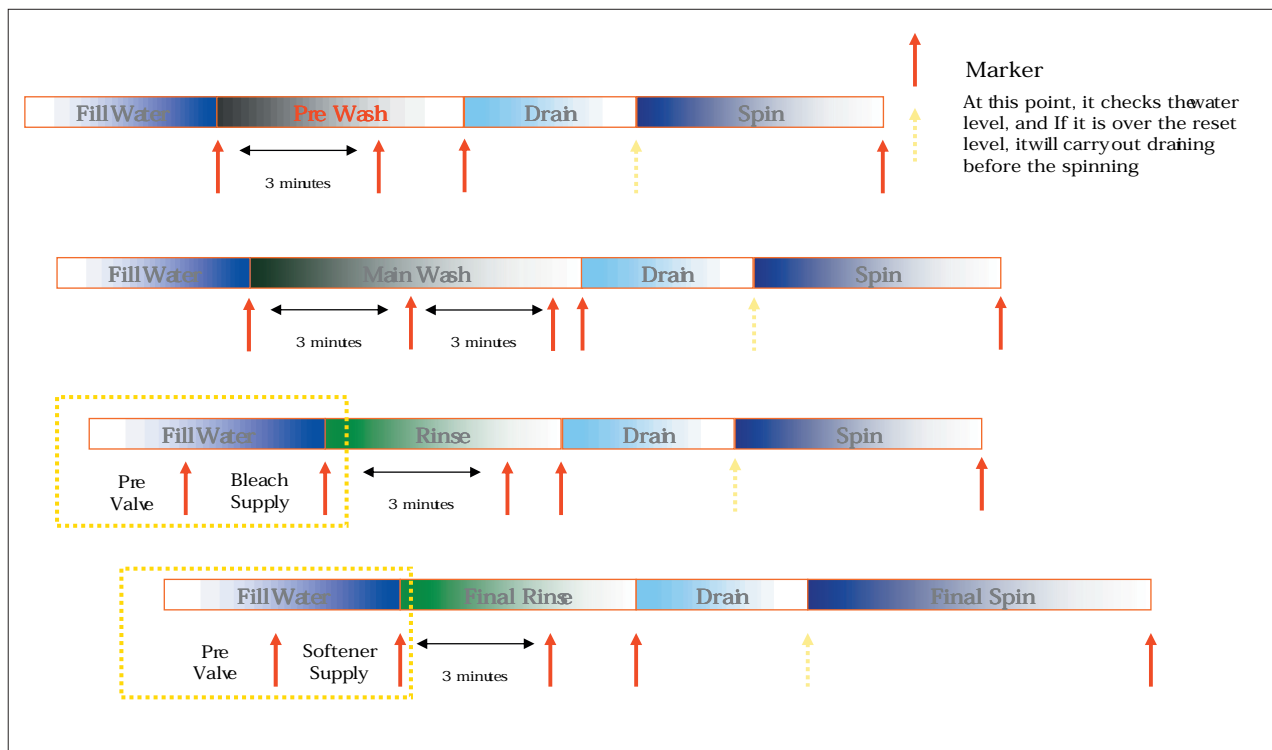



## 4-2-9. Board Input Test Mode

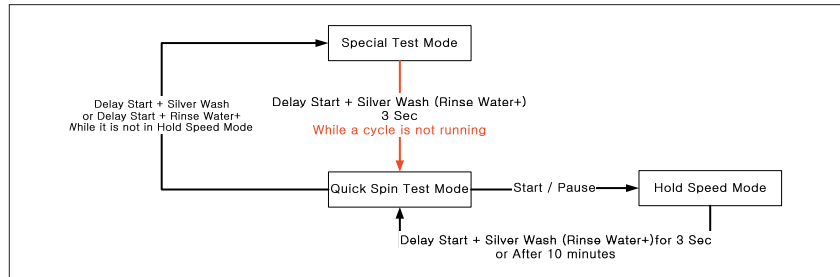

Definition of Board Input Test Mode:

- Board Input Test Mode is to displays a specified input after a key press.

How to Enter:

- To enter the Board Input Test Mode, press the Extra Wash key during Special Test Mode.  
(same for all Frontier models.)

Board Input Test Mode:

1. Activate the Special Test Mode first.
2. Press the Extra Wash key to start Board Input Test.
3. Water Temperature Display in Celsius Dial the Rotary Cycle Selector to "Heavy Duty" and press the Start/Pause dial.
4. Water Temperature Display in Fahrenheit Dial the Rotary Cycle Selector to "Normal" and press the Start/Pause dial.
5. Door Position (Open/Close) Display Dial the Rotary Cycle Selector to "Whites" and press the Start/Pause dial: "OP" will illuminate if open, "CL" if closed.
6. Door Status (Lock/Unlock) Display Dial the Rotary Cycle Selector to "Perm Press" and press the Start/Pause dial: "UL" will illuminate if unlocked, "LO" if locked.
7. Overflow Water Level Display Dial the Rotary Cycle Selector to "Delicate/Hand Wash" and press the Start/Pause dial: "0" will illuminate if below level, "1" if above level (Overflow). The above water level is defined as the overflow water level.
8. Heater-On Water Level Display Dial the Rotary Cycle Selector to "Wool" and press the Start/Pause dial: "0" will illuminate if below level, "1" if above level (Heater-On). The Medium water level is defined as the level needed for the heater to turn on.
9. Reset Water Level Display Dial the Rotary Cycle Selector to "Quick Wash" and press the Start/Pause dial: "0" will illuminate if below level (Reset), "1" if above level.
10. Water Level Display (Frequency) Dial the Rotary Cycle Selector to "Towels" and press the Start/Pause dial: If it illuminates "2435", it indicates 24.35 kHz.
11. AG Kit Status Dial the Rotary Cycle Selector to "Rinse+Spin" and press the Start/Pause dial. Then, it will display the Ag Kit Status in 3 seconds: "-" if AG kit is operated properly. "7E" if AG kit is out of order (check wire harness & PCB)
12. MEMS Sensor Kit Status. Dial the Rotary Cycle Selector to "Spin Only" and press the Start/Pause dial. Then, it will display the MEMS Sensor Kit status after displaying "00" for 3 seconds: "-" if MEMS Sensor kit is operated properly. "8E" if MEMS Sensor kit is out of order (check wire harness & PCB)

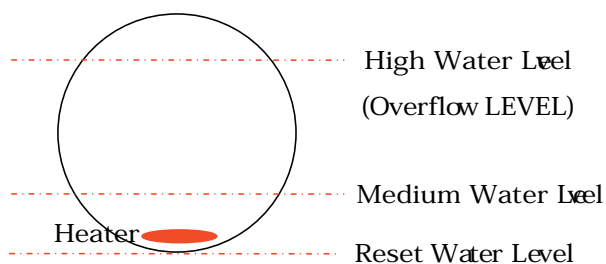

## 4-2-10. Diagnostic Code Check Mode

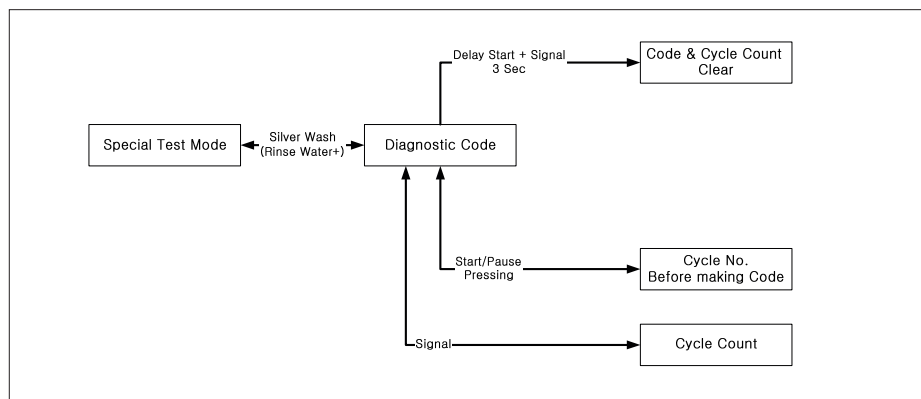

Definition of Diagnostic Code Check Mode:

- Diagnostic Code Check Mode is to bring up the stored diagnostic codes (reference codes for service technicians).

How to Enter:

- To enter the Diagnostic Code Check Mode with code "d" flashing, press the Silver Wash (Rinse Water +) during Special Test Mode. (same for all Frontier models.)

Board Input Test Mode:

1. Activate the Special Test Mode first.
2. Press the "Silver Wash (Rinse Water +)" key to start Diagnostic Code Check Mode with Code "d" flashing.
3. To cycle through the diagnostic codes (d1,d2,d3~d9), turn the Rotary Cycle Selector in one direction (either Clockwise or Counterclockwise).
4. Now, when turning the Rotary Selector Key in the same direction, it shows diagnostic codes from the latest (d1).
5. When turning it in the opposite direction, it shows the diagnostic codes in the reverse order.  
Ex) When it stops at d5 and turns backward, it shows from d4 down to "d".
6. EEPROM holds the codes up to 9 of them. So, when it goes beyond it, "-" and "d" will light up.  
Ex) "d" – d1~d9 – "-"
7. When there are only 6 codes stored in EEPROM, it will display "-" after them.

Refer to Diagnostic Code.

---

# Memo

---

## 5. ASSEMBLY AND DISASSEMBLY

### 5-1. TOOLS FOR DISASSEMBLY AND ASSEMBLY

NO.	TOOL		
1	Box driver	10mm 13mm 19mm	Heater (1) Motor (1), Balance (5), 2 holes of each left and right of the shock absorber 1 Pulley hole
2	Double-ended spanner	10, 13,19mm	Replaceable for the box driver. Since the bolt runs idle when the box driver is used, use the box driver 17mm.
3	Vice pliers		Tool to protect the idle and abrasion of the bolt for the box driver.
4	Other(Driver, Nipper, Long nose)		General tools for the after service.
5	JIG for the Tub		1 (Disassemble and Assemble)

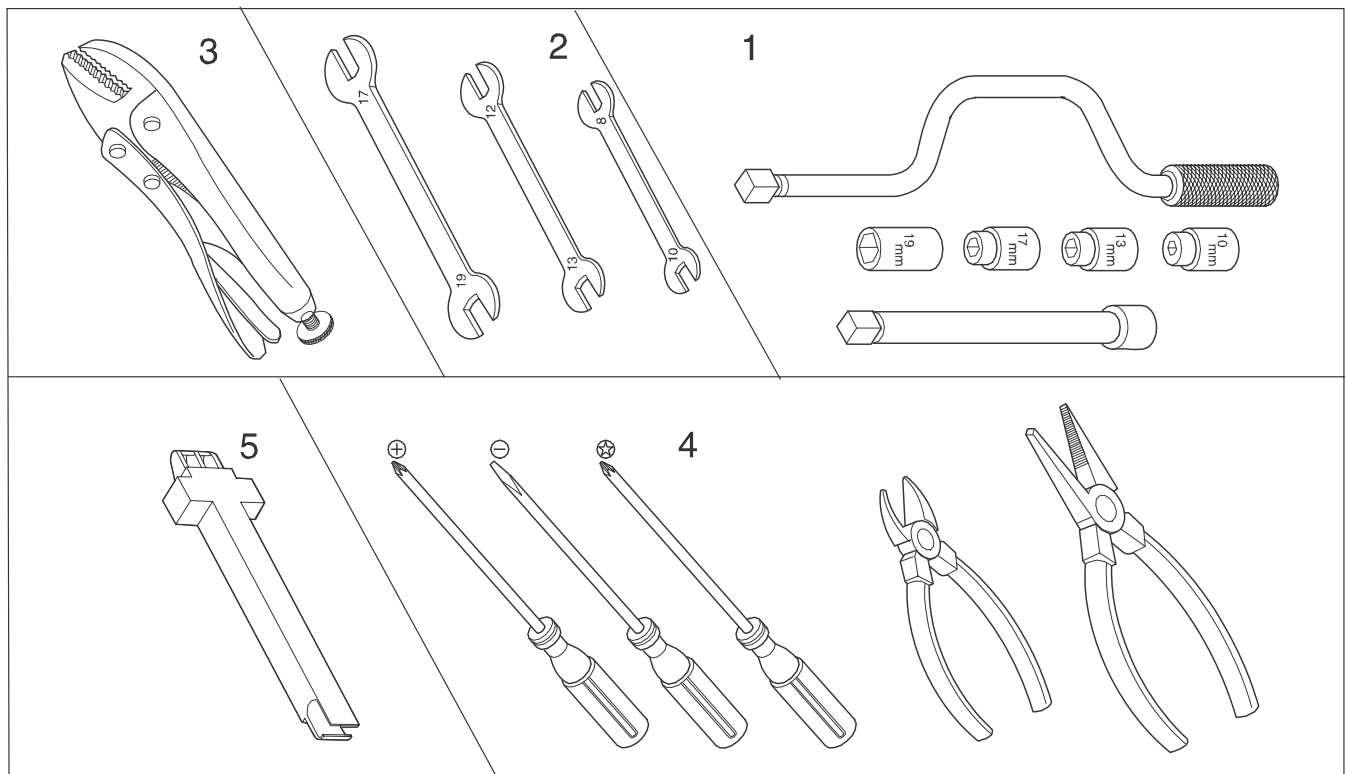



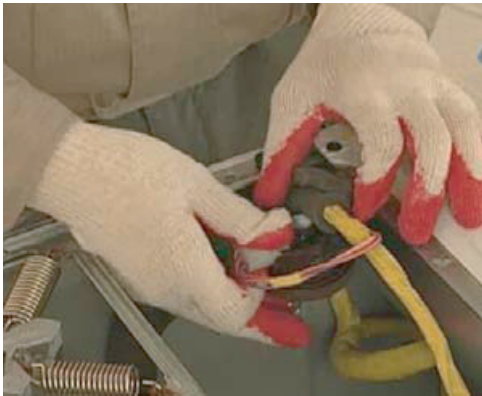
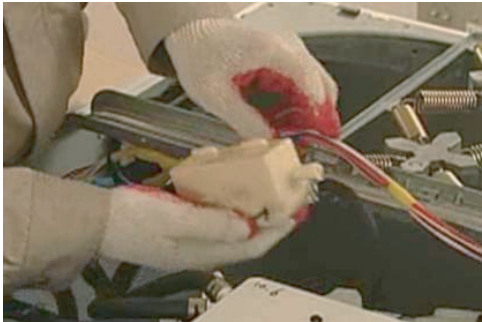

## 5-2. DISASSEMBLY



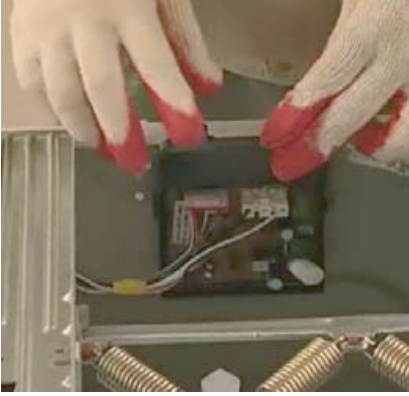

Warning! To avoid risk of electrical shock, personal injury or death, disconnect the power to the washing machine.

Part Name	Descriptive Picture	How To Do
<b>Top Cover</b>		<ol style="list-style-type: none"> <li>1. Unplug the unit.</li> <li>2. Remove screws(2ea) at the back.</li> <li>3. Slide Top Cover back and lift it up.</li> </ol>
<b>Water Level Sensor</b>		<ol style="list-style-type: none"> <li>1. Unplug the unit.</li> <li>2. Remove Top Cover.</li> <li>3. Remove the screw(1ea).</li> <li>4. Disconnect the wire harness.</li> <li>5. Take out Pressure Hose.</li> </ol>
<b>Ag Kit</b>		<ol style="list-style-type: none"> <li>1. Unplug the unit.</li> <li>2. Remove Top Cover.</li> <li>3. Remove screws(2ea) from the rail.</li> <li>4. Disconnect the wire harness.</li> <li>4. Remove clamps and hoses.</li> </ol>

## 5-2. DISASSEMBLY



Part Name	Descriptive Picture	How To Do
<b>Ag PCB</b>		<ol style="list-style-type: none"> <li>1. Unplug the unit.</li> <li>2. Remove Top Cover.</li> <li>3. Flip open the PCB cover.</li> <li>4. Disconnect the wire harness.</li> <li>5. Remove screws (2ea) on the frame.</li> </ol>
<b>EMI Filter</b>		<ol style="list-style-type: none"> <li>1. Unplug the unit.</li> <li>2. Remove Top Cover.</li> <li>3. Remove the earth screw.</li> <li>3. Remove the acorn nut (13mm) and disconnect the wire harness.</li> </ol>
<b>Water Valve</b>		<ol style="list-style-type: none"> <li>1. Unplug the unit.</li> <li>2. Remove Top Cover.</li> <li>3. Remove two screws for each Single Hot and 3-Combo Cold Valve.</li> <li>4. Remove clamps and hoses.</li> </ol>
<b>Dispenser</b>		<ol style="list-style-type: none"> <li>1. Unplug the unit.</li> <li>2. Remove Top Cover.</li> <li>3. Remove Dispenser Drawer.</li> <li>4. Remove screws(3ea) on the top.</li> <li>5. Plug out all the connectors.</li> <li>6. Unscrew(6ea) PCB and separate it from Console.</li> </ol>

## 5-2. DISASSEMBLY

Part Name	Descriptive Picture	How To Do
<b>Console</b>		<ol style="list-style-type: none"> <li>1. Unplug the unit.</li> <li>2. Remove Top Cover.</li> <li>3. Remove Dispenser Drawer.</li> <li>4. Remove screws(3ea) on the top.</li> <li>5. Plug out all the connectors.</li> <li>6. Unscrew(6ea) PCB and separate it from Console.</li> </ol>
<b>Door</b>		<ol style="list-style-type: none"> <li>1. Unplug the unit.</li> <li>2. Remove screws(2ea) and takeout Door Assy from Front Panel.</li> <li>3. Remove screws along the perimeter of Glass Retainer.</li> <li>4. Remove Glass Retainer.</li> <li>5. Remove Door Glass.</li> <li>6. Remove Hinge.</li> <li>7. Remove Outer Window Panel.</li> </ol>
<b>Front Panel</b>		<ol style="list-style-type: none"> <li>1. Unplug the unit.</li> <li>2. Remove Top Cover, Dispenser, Console and Door.</li> <li>4. Snap up the boot at 6 o'clock and pull out the clamp spring.</li> <li>5. Pull the boot from the lip formed into the front opening.</li> <li>6. Remove screws(2ea) on the bottom.</li> <li>7. Remove screws(4ea) on the top.</li> <li>8. Plug out the connectors to Door Lock.</li> <li>9. Lift out Front Panel.</li> </ol>
<b>Boot</b>		<ol style="list-style-type: none"> <li>1. Unplug the unit.</li> <li>2. Knock the unit down to Front Panel (included).</li> <li>3. Unscrew the boot clamp at 12 o'clock.</li> <li>4. Pull out the boot.</li> </ol>

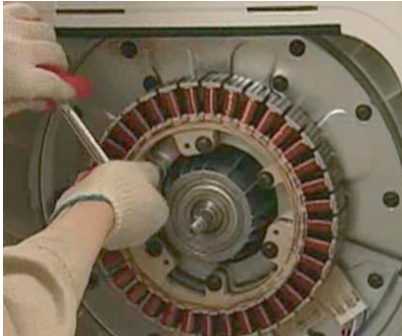

## 5-2. DISASSEMBLY

Part Name	Descriptive Picture	How To Do
<p><b>Heater</b></p>		<ol style="list-style-type: none"> <li>1. Unplug the unit.</li> <li>2. Knock the unit down to Front Panel (included).</li> <li>3. Remove the wire connectors.</li> <li>4. Remove the nut (10mm) in the center and take out Heater.</li> </ol>
<p><b>Motor</b></p>		<ol style="list-style-type: none"> <li>1. Unplug the unit.</li> <li>2. After removing screws(2ea) on Back Cover, take out Back Cover by sliding it up.</li> <li>4. Rotate Motor Cover to locate a slot in Stator. Insert a Phillips screwdriver into the slot to lock Stator.</li> <li>5. Remove the nut (19mm).</li> <li>6. Grab Motor Cover at 3 and 9 o'clock and pull it out.</li> <li>7. Remove the bolts (6ea, 10mm) securing Stator Coil to Tub.</li> <li>8. Remove the wire connectors.</li> </ol>
<p><b>Drain Pump</b></p>		<ol style="list-style-type: none"> <li>1. Unplug the unit.</li> <li>2. Remove Back Cover.</li> <li>3. Remove the wire connector.</li> <li>4. Remove Clamp and Drain Hose.</li> <li>5. Remove Clamp and Pump Hose.</li> <li>6. Remove the bolts (3ea, 13mm) securing Drain Pump to Cabinet Bottom.</li> <li>7. Remove the screw securing Drain Pump to the support bracket. Twist Drain Pump clockwise to remove.</li> </ol> <p>* Make sure to put an empty container under Drain Pump to hold water inside.</p>



## 5-2. DISASSEMBLY

Part Name	Descriptive Picture	How To Do
<p><b>Outer Tub and Spinner(1)</b></p>		<ol style="list-style-type: none"> <li>1. After the above knock-down to Drain Pump, do the following.</li> <li>2. Remove screws holding the wire harness.</li> <li>3. Remove the bolts (2ea,13mm) securing Rear Struts to Cabinet Bottom.</li> <li>4. Swing Struts up against Tub to make it easy to remove Tub Assy.</li> <li>5. Remove bolts (2ea each side, 13mm) securing Counter Weights.</li> <li>6. Remove the screw holding the wire harness.</li> <li>7. Remove bolts (2ea each side, 13mm) securing Front Struts to Cabinet Bottom and swing Struts up against Tub..</li> <li>8. Loop the wire harness and Water Pressure Hose out of its retaining holders.</li> <li>9. Remove screws (7ea) securing Rail Frame and take it off.</li> <li>10. Remove Clamp and Vent Hose.</li> <li>11. Loop out Suspension Spring by lifting it up (each side).</li> <li>12. Take out Tub and put it on block supports (4" wood blocks or their equivalents) to prevent shaft damage.</li> <li>13. Remove screws (10mm) around the perimeter of the tub.</li> <li>14. Separate Front and Back Tubs from each other.</li> <li>15. Take out Spinner Drum.</li> <li>16. Remove screws to disassemble Baffles.</li> </ol> <p>* When assembling, make sure that Front and Back Tubs are fastened up tightly. If not, it will cause water leakage.</p>

---

**Memo**

---

---

## 6. TROUBLE SHOOTING

---

### 6-1. TROUBLE DIAGNOSIS

---

- As the micom wash machine is configured of the complicate structure, there might be the service call.

Below information is prepared for exact trouble diagnosis and suitable repair guide.

### Caution for the Repair and Replacement

---

Please follow below instruction for the trouble diagnosis and parts replacement.

- 1) As some electronic components are damaged by the charged static electricity from the resin part of wash machine or the human body, prepare the human body earth or remove the potential difference of the human body and wash machine by contacting the power supply plug when the work contacting to PCB is executed.

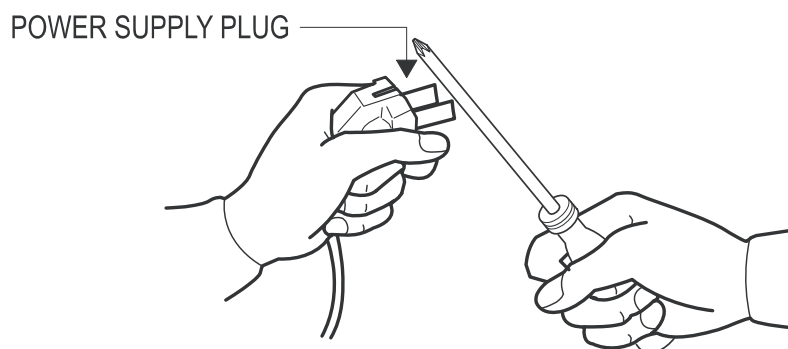

- 2) Since AC220~240V is applied to the triac T1 and T2 on P.C.B, the electric shock may occur by touching and be careful that the strong and weak electricity are mixed.
- 3) As the P.C.B assembly is designed for no trouble, do not replace the P.C.B assembly by the wrong diagnosis and follow the procedure of the trouble diagnosis when the micom is not operated normally.

---

## 6-1. TROUBLE DIAGNOSIS

---

### WARNING

To avoid risk of electrical shock, personal injury or death, disconnect power to unit before servicing, unless testing requires power.

### Will Not Start

- Plug the unit into the wall outlet. Check for proper voltage.
- Check fuse or reset circuit breaker.
- Push any key to turn on the washer and press the Start/Pause key to run the washer.
- Close door and push the Start/Pause key to run the washer.
- Check if washer is in a pause, soak or suds process.  
Wait briefly and it may start. (If the washer is in suds period, Suds will light up instead of remaining time.)
- Check for restricted drain system.  
(If there is electrical problem in drain system, "nd" error will occur after 15 minutes.)
- Check Water Supply.
- Check the line or water valve screen filter.
- Check if PCB connectors are assembled properly.
- Check if CN5, CN6 terminals on PCB are in good condition.  
(Refer to PCB Connector Check.)
- Replace PCB.

### Leaking

- Start a normal cycle with the drum empty and fill her up to check its tumbling.
- Perform Quick Test Mode or Quick Spin Test  
(Carry it out without laundry in the unit.)
- Check for loose connections at PCB, Water Level Sensor, Motor, Hall Sensor Wire Harness, etc. (Refer to the Component Testing Procedure)
- Check motor windings resistance.  
(CN9 1 & 3 = 11.6 ohms ( $\pm 7\%$  20°C basis),  
CN9 1 & 2 = 11.6 ohms ( $\pm 7\%$  20°C basis),  
CN9 2 & 3 = 11.6 ohms ( $\pm 7\%$  20°C/68°F basis))
- If it doesn't tumble after all of the above tests, change PCB. When the problem persists, change the motor.

### No Tumble

- Start normal cycle with an empty machine and allow a fill to check tumble.
- Perform Quick Spin Test. (Before test, make sure that the tumbler is empty.)
- Check for loose connections at Machine Control Board, Pressure Switch, Motor, Tach Harness and Motor Control. (Refer to the component testing procedure)
- Check motor windings resistance.  
CN9 pins 1 & 3 = 11.6ohms  $\pm 7\%$ ,  
Pins 1 & 2 = 11.6ohms  $\pm 7\%$ ,  
Pins 2 & 3 = 11.6 ohms  $\pm 7\%$
- Faulty Main Control Board.
- Faulty motor.

### Will Not Spin

- Make sure to close the door completely.
- Check for water left inside the washer. If so, go to "Will Not Drain".
- Perform Quick Test Mode or Quick Spin Test.  
Does the washer spin? (Before the test, empty the unit inside.)  
If it doesn't tumble after the above, change PCB.  
When the problem persists, change the motor.
- Perform Quick Test Mode or Quick Spin Test.  
Does the washer spin? If it does, Check Possible unbalanced load scenario in normal mode.
- Check for loose connections at PCB, Water Level Sensor, Motor, Hall Sensor Wire Harness. (CN8,CN9,CN3)  
(Refer to the Component Testing Procedure.)
- Check motor windings resistance.  
(CN9 Pin1&3 = 11.6 ohms (at  $\pm 7\%$  20°C/68°F),  
Pin1&2 = 11.6ohms (at  $\pm 7\%$  20°C),  
Pin2&3 = 11.6 ohms (at  $\pm 7\%$  20°C))

---

## 6-1. TROUBLE DIAGNOSIS

---

### No Water Fill

- Perform Quick Test Mode.  
Check all of Water Valves visually.  
(Pre Wash Valve, Cold Water Valve, Bleach Water Valve, Softener dispenses using Cold & Bleach Water Valve, and Hot Water Valve.)
- Check if water taps are turned on fully.
- Check Water Valves and Water Level Sensor (Refer to PCB Connector Check)
- Check if there is any kink in inlet hoses.
- Check if inlet screens are clogged up.
- Check if water has enough pressure. If so, find out its contributors.
- Check if there is any frozen area in the unit (Drain Hose, etc)
- Measure the resistance of Water Valve Coil.  
(It should read 1.18K ohms. Check Pin#1 of CN5 and PIN#1,2,3,4 of CN10)
- Check Pressure S/W and PCB for loose connections.  
(Refer to PCB Connector Check.)

### Tub Full of Suds

- Go to “Will Not Drain” and “Will Not Spin” and check the draining.
- Check PCB and Drain Pump for any loose wire connection.
- Perform Quick Test Mode or Board Output Test to drain.
- Use HE (High-Efficiency) or low sudsing detergent specially formulated for front load washers.
- Reduce the amount of detergent for that specific load size and soil level. Keep in mind that towel creates more suds generally.
- Reduce the amount of detergent when water is soft, or laundry is small or lightly soiled.
- Do one more washing cycle with cold water and a table spoon of salt without detergent.

### Wet Clothes

- Unbalance due to not enough load. Put additional load.
- Due to excessive suds by using general detergent.  
Use HE (High-Efficiency) or reduce its quantity.
- Low Spin Speed or Drain Only was selected.
- Go to “ Will Not Spin”.

### Will Not Lock

- Door is not aligned or closed properly.
- Perform Quick Test Mode.  
Check Door Lock.  
Check the output voltage of Door Lock Coil.  
If it reads 120V, change Door Lock Switch, and if not, change PCB.  
(Refer to PCB Connector Check.)
- Read Lock Switch and PCB (CN10).  
(Refer to PCB Connector Check.)
- Try Door Lock and check for 120V to Door Lock Connector.  
If 120V present, change Main Control Board and if not, change Door Lock switch.

---

## 6-1. TROUBLE DIAGNOSIS

---

### Will Not Unlock

- Check if the door is being pushed out, which may keep it from unlocking.
- Door locks itself when the water level is too high. Opening door will result in water draining from door opening.
- Check the following with Board Input Test Mode.
  - Water Level (frequency): Over 23.80 KHz.
    - If so, refer to "Will Not Drain".
  - Temperature (Inside Drum): Higher than 60°C/140°C.
    - If so, wait until it drops.
- When everything is normal, check PCB connectors and Door Lock Switch.
- Drain manually after removing the plastic drain hose holder.
- Display shows "LO". Turn off and on the unit.
  - If "LO" keeps illuminating, check PCB and Door Lock Switch.
- Read Lock Switch and PCB (CN10 & CN7).
  - (Refer to PCB Connector Check.)
- Perform Quick Test Mode.
  - Check Door Lock.
  - Check the output voltage of Door Lock Coil.
  - If it reads 120V, change Door Lock Switch, and if not, change PCB.
    - (Refer to PCB Connector Check.)

### No Key Operation

- Option and Function buttons respond differently according to each cycle.
- Child Lock is being activated. To exit, hold down Soil Level Key and Signal Key simultaneously until it sends out a beeping sound.
- When "End" illuminates on the display, only Power button works. Press Power button and make new cycle selections.

### Will Not Drain

- Check for any kink on the drain hose. If any, straight it out.
- Check for any restriction in the drain hose.
- Close the door and press the Cycle Selector dial. For safety reasons, the washer does not tumble or spin with the door open.
- When it is freezing outside, check if it is frozen inside the drain hose.
- Check if the water level signal input is correct. Go to Board Input Test Mode.
- Go to Quick Test Mode and do Drain Pump Test.
- Check if there is any twist in the hose (the one between Tub and Drain Pump).
- Check if it reads AC 120V at the pump when a spin cycle is selected.
- Read the winding resistance of the pump motor. (14.2 7% Ohms)
- Check the pump at CN10 (Pin6) on PCB. It should read AC 110~120V. (Refer to PCB Connector Check)

### Wrong Water Temperature

- Check if both of the water taps are fully open.
- Make sure the domestic water heater is set to deliver water lower than 120°F (49°C) hot water at the tap.
  - Also check water heater capacity and recovery rate.
- If the water heater is located far from the washer, screw out the hot water tap and let its water pass until you get hot water.
- Too Hot/Too Cold: Reduced amount of water is supplied while PCB controls the influx to regulate the actual temperature of the water in the tub. This may appear to be significantly hotter/colder than expected.
- Check if the temperature selection is correct.
- Disconnect inlet hoses from the Water Valve and remove any residue in the inlet screens.

### Noisy and/or Vibration/Walking

- Check if the washer is leveled and the lock nuts are tightened up on the bottom plate.
- Check if all of the shipping bolts and spacers are removed from the back panel.
- Check if load is big enough and there is no unbalance. If there is not enough load, put in a few towels to balance it.
- Check if the motor is fastened enough.
- Remove various trouble contributors (such as dust coat on the floor).

---

## 6-1. TROUBLE DIAGNOSIS

---

### **Rubber Feet Leaving Marks on Floor**

- Use a pencil eraser to remove mark.
- Walk washer into location, do not drag.

### **Additive Cups Full of Water**

- Small amount of water in bottom of additive cups is normal.
- Remove and wash Dispenser Tray, removable Cup, and Rinse Cap.
- Level washer.

### **Buttons do not Respond**

- Option and Function buttons respond differently according to each cycle.
- Child Lock feature has been selected. To disable feature press and hold Temp and Spin simultaneously until a beep is heard.
- When display shows "End", only the Power button will function. Press Power and make new cycle selections.

## 6-2. PROBLEM CHECKING AND METHOD OF PCB

-If you plug in the power cord and turn Power S/W on, memorized data is displayed.  
If any data is not displayed, check the followings.

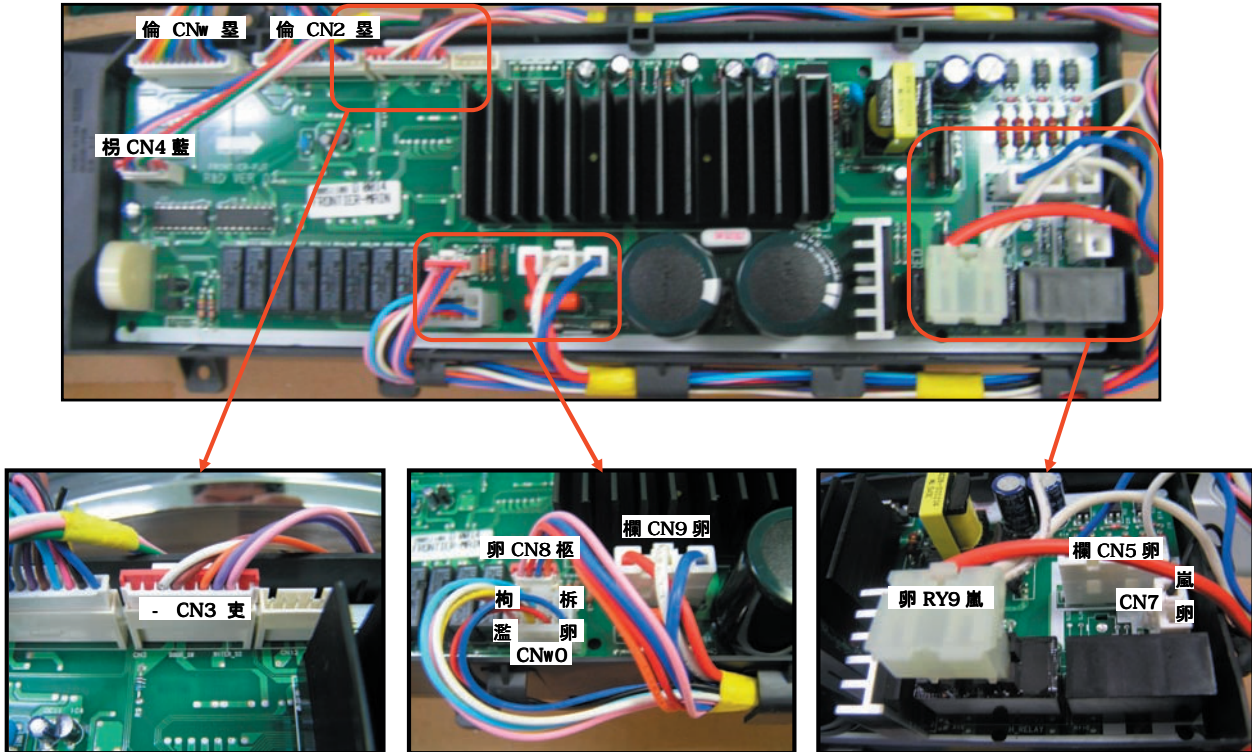

### Thermistor Check

Check Voltage at Pin #6 and #3 of CN3  
Tester Check = DC2.5V  
If it reads 5V, check if its connector is engaged properly.

### Door Switch Check

Check Voltage at Pin #6 and #4 of CN3  
When Door Open = DC5V  
When Door Close = DC0V

### Water Sensor Check

Check Voltage and Frequency at Pin #6 and #7 of CN3  
Reset water level = DC2.5V, 25.8KHz  
Check Voltage and Frequency at Pin #6 and #8 of CN3  
Reset water level = DC2.5V, 25.8KHz

### Sump Sensor Check

Check Voltage at Pin #4 and #2 of CN8  
Tester Check = DC0V or 3.75V  
Check Voltage at Pin #4 and #3 of CN8  
Tester Check = DC0V or 3.75V

### Motor Check

Resistance at Pin #1 and #2 of CN9 = 11.6Ω  
Resistance at Pin #1 and #3 of CN9 = 11.6Ω  
Resistance at Pin #2 and #3 of CN9 = 11.6Ω

### Door Lock Check

Check Voltage at Pin #1 of CN5 and Pin #7 of CN10  
When Door Lock = AC120V  
Check Voltage at Pin #1 of CN5 and Pin #2 of CN7  
When Door Lock = AC120V

### Door Unlock Check

Check Voltage at Pin #1 of CN5 and Pin #8 of CN10  
When Door Unlock = AC120V

### Drain Motor Check

Check Voltage at Pin #1 of CN5 and Pin #6 of CN10  
When Drain Pump operates = AC120V

### Water Valve Check

Check Voltage at Pin #1 of CN5 and Pin #1,2,3,4 of CN10  
When each Valve operates = AC120V

### AC Power Check

Check Voltage at Pin #1 and #3 of CN5  
Check Voltage at Pin #1 of CN5 and Pin #1 of CN6  
Tester Check = AC120V

### Heater Relay Check

Check Voltage at Pin #1 of CN5 and Pin #2 of RY9  
When Heater Relay operates = AC120V



---

## **Memo**

---

## 7. EXPLODED VIEW AND PARTS LIST

### 7-1. THE CONTROL PARTS

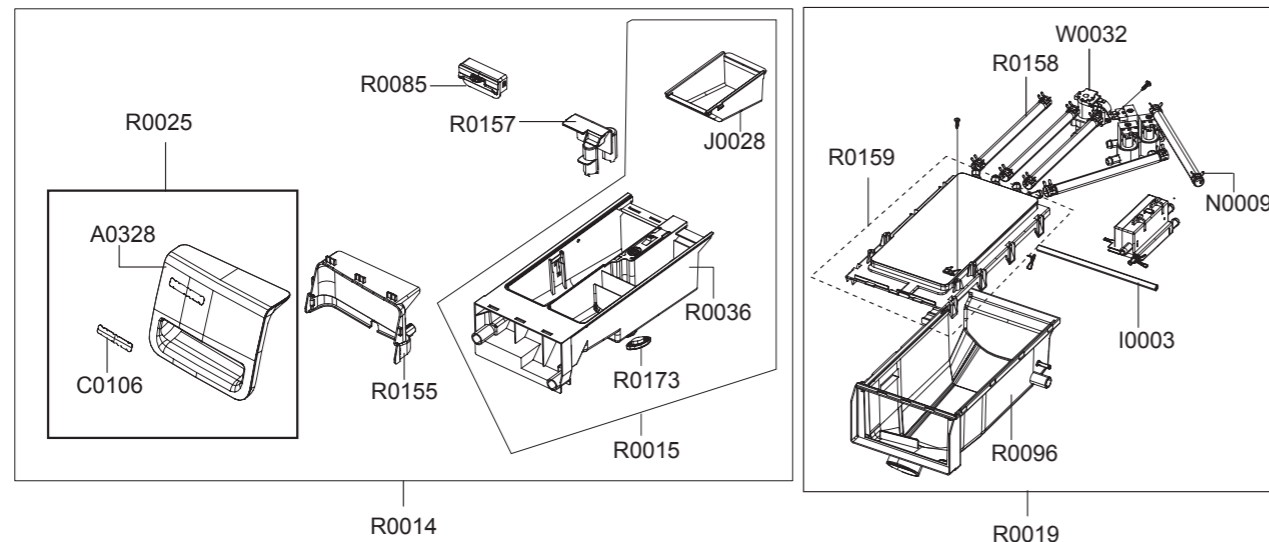
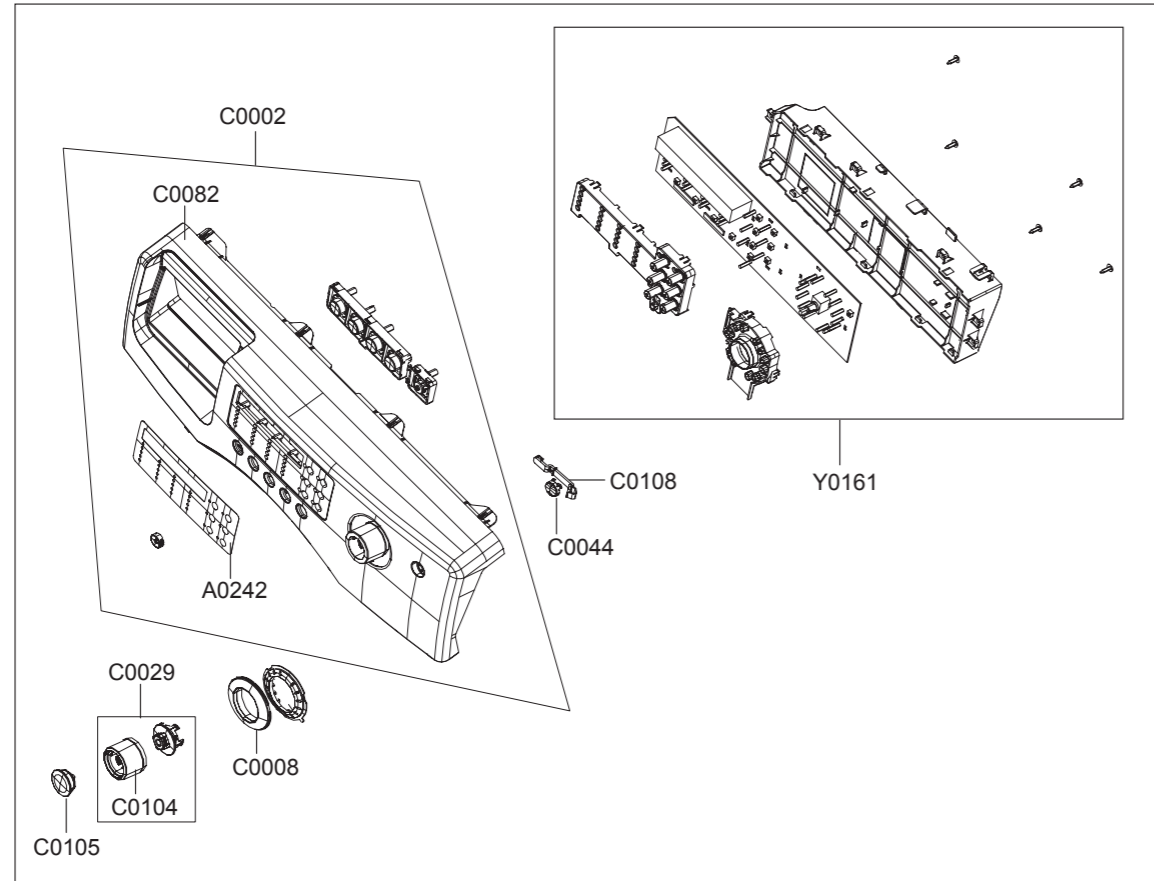

No.	SVC_Code	Code	Description	Spec	EA	SA	Remark
1	A0242		INLAY-PANEL	WF316LAW,PET,T0.188,WHT,	1		WF316LAW,WF316BAW
2	A0242		INLAY-PANEL	WF306BHW,PET,T0.188,WHT,	1		WF306BHW
3	A0242		INLAY-PANEL	WF306LAW,PET,T0.188,WHT,	1		WF306LAW
4	A0242		INLAY-PANEL	WF316BAC,PET,T0.188,SILK	1		WF316BAC
5	A0242		INLAY-PANEL	WF316LAS,PET,T0.188,IMPE	1		WF316LAS
6	A0328		PANEL-DRAWER	WF326LAW,ABS,WHT,LO	1		WF316LAW,WF306LAW
7	A0328		PANEL-DRAWER	WF-G106AW,ABS,WHT,B	1		WF316BAW,WF306BHW
8	A0328		PANEL-DRAWER	WF326LAS,ABS,IMPERI	1	SA	WF316LAS
9	A0328		PANEL-DRAWER	WF316BAC,ABS,SILKY	1	SA	WF316BAC
10	C0002		ASSY-PANEL CONTROL	WF306BHW,BBY	1		WF306BHW
11	C0002		ASSY-PANEL CONTROL	WF306LAW,LOWES	1		WF306LAW
12	C0002		ASSY-PANEL CONTROL	WF316BAW,BBY	1		WF316BAW
13	C0002		ASSY-PANEL CONTROL	WF316BAC,BBY	1		WF316BAC
14	C0002		ASSY-PANEL CONTROL	WF316LAS,LOWES	1		WF316LAS
15	C0002		ASSY-PANEL CONTROL	WF316LAW,LOWES	1		WF316LAW
16	C0008		WINDOW-ENCODER	WF326LAW,SAN,TRAN	1		WF316LAW,WF316BAC WF316BAW,WF306BHW WF316LAS,WF306LAW
17	C0029		ASSY-KNOB ENCODER	FRONTIER,BBY	1	SA	WF316BAC,WF316BAW WF306BHW
18	C0029		ASSY-KNOB ENCODER	FRONTIER,LOWES	1	SA	WF316LAW,WF316LAS WF306LAW
19	C0044		BUTTON-PUSH(P)	WF326LAW,ABS,WHT,FRON	1	SA	WF316LAW,WF316BAW WF306BHW,WF306LAW
20	C0082		PANEL-CONTROL	WF316LAW,ABS,WHT,I	1		WF316LAW,WF316BAW WF306BHW,WF306LAW
21	C0082		PANEL-CONTROL	WF316BAC,ABS,SILKY	1		WF316BAC
22	C0082		PANEL-CONTROL	WF316LAS,ABS,IMPER	1		WF316LAS
23	C0104		KNOB-ENCODER	WF-G126AW,ABS,WHT	1		WF316BAC,WF316BAW WF306BHW
24	C0104		KNOB-ENCODER	WF326LAW,ABS,WHT,	1		WF316LAW,WF316LAS WF306LAW
25	C0105		BUTTON-ENCODER	WF-G126,ABS,WHT,FRONT	1	SA	WF316BAW,WF306BHW
26	C0105		BUTTON-ENCODER	WF326LAW,ABS,WHT,FRON	1	SA	WF316LAW,WF306LAW
27	C0105		BUTTON-ENCODER	WF316BAC,ABS,SILKY CH	1	SA	WF316BAC
28	C0105		BUTTON-ENCODER	WF326LAS,ABS,IMPERIAL	1	SA	WF316LAS
29	C0106		MASCOT	WF326LAW,NICKEL,T0.5,W10.5,L65	1		WF316LAW,WF316BAC WF316BAW,WF306BHW WF316LAS,WF306LAW
30	C0108		LEVER-POWER	GW-PJT,POM,NTR,ENTRY	1	SA	WF316LAW,WF316BAC WF316BAW,WF306BHW WF316LAS,WF306LAW
31	I0003		HOSE-WATER	WF326LAW,EPDM,ID5,OD9,T2,L190	1	SA	WF316LAW,WF316BAC WF316BAW,WF306BHW WF316LAS,WF306LAW
32	J0028		CASE-PRE WASH	WINGS-PJT,PP(TB53),W	1	SC	WF316LAW,WF316BAC WF316BAW,WF316LAS
33	N0009		CLAMPER HOSE	SEW-DR605,SK5,YEL,ID14.	10	SA	WF316LAW,WF316BAC WF316BAW,WF306BHW WF316LAS,WF306LAW
34	N0012		CLAMPER HOSE	P1291,LYLON6/6,ID27,OD30,	2		
35	R0014		ASSY-DRAWER	WF306LAW,NEAT-WHT/3-TRAY	1	SA	WF306LAW
36	R0014		ASSY-DRAWER	WF316LAS,IMPERIAL-SIL	1	SA	WF316LAS
37	R0014		ASSY-DRAWER	WF316LAW,NEAT-WHT	1	SA	WF316LAW
38	R0014		ASSY-DRAWER	WF306BHW,NEAT-WHT/3-TRAY	1	SA	WF306BHW
39	R0014		ASSY-DRAWER	WF316BAC,SILKY-CHAMPAGNE	1	SA	WF316BAC

**7-1. THE CONTROL PARTS**

No.	SVC_Code	Code	Description	Spec	EA	SA	Remark
40	R0014		ASSY-DRAWER	WF316BAW,NEAT-WHT	1	SA	WF316BAW
41	R0019		ASSY-HOUSING DRAWER	WF326LAW,FRONTIER	1	SA	WF316LAW,WF316BAC WF316BAW,WF316LAS
42	R0036		BODY-DRAWER	GW-PJT,PP(TB-53),WHT	1		WF316LAW,WF316BAC WF316BAW,WF306BHW WF316LAS,WF306LAW
43	R0085		GUIDE-LIQUID	GW-PJT,ABS,WHT	1	SA	WF316LAW,WF316BAC WF316BAW,WF306BHW WF316LAS,WF306LAW
44	R0096		HOUSING-DRAWER(L)	WF316LAW,PP(FH44N)	1	SA	WF316LAW,WF316BAC WF316BAW,WF306BHW WF316LAS,WF306LAW
45	R0097		HOUSING-DRAWER(M)	GW-PJT,PP(TB-53)	1		WF316LAW,WF316BAC WF316BAW,WF306BHW WF316LAS,WF306LAW
46	R0098		HOUSING-DRAWER(U)	GW-PJT,PP(TB-53)	1		WF316LAW,WF316BAC WF316BAW,WF306BHW WF316LAS,WF306LAW
47	R0155		HANDLE-DRAWER	WF326LAW,ABS,WHT,F	1	SA	WF316LAW,WF316BAC WF306BHW,WF306LAW
48	R0157		CAP-RINSE	MAH9700,PP(TB53),MUNSELL	1	SA	WF316LAW,WF316BAC WF316BAW,WF306BHW WF316LAS,WF306LAW
49	R0158		HOSE-DRAWER	Q1636GW/XEU,EPDM,ID9.0,OD14.	1.48	SA	WF316LAW,WF316BAC WF316BAW,WF316LAS
50	R0158		HOSE-DRAWER	Q1636GW/XEU,EPDM,ID9.0,OD14.	1.12	SA	WF306BHW,WF306LAW
51	R0159		ASSY-S.HOUSING DRAWER	MAH9700AWW	1	SA	WF316LAW,WF316BAC WF316BAW,WF306BHW WF316LAS,WF306LAW
52	R0173		COVER-DETERGENT	GW-PJT,PP(TB-53)	1		WF316LAW,WF316BAC WF316BAW,WF306BHW WF316LAS,WF306LAW
53	W0032		VALVE-WATER	GW-PJT,NYLON,MAX10BAR,NTR,	1	SA	WF316LAW,WF316BAC WF316BAW,WF306BHW WF316LAS,WF306LAW
54	W0032		VALVE-WATER	GW-PJT,NYLON,3WAY,MAX 10BAR,	1	SA	WF316LAW,WF316BAC WF316BAW,WF316LAS
55	W0032		VALVE-WATER	GW-PJT,NYLON,2WAY,MAX 10BAR,	1	SA	WF306BHW,WF306LAW
56	Y0002		GUIDE-PCB	GW-PJT,ABS(V0),NTR,STAND	1		WF316LAW,WF316BAC WF316BAW,WF306BHW WF316LAS
57	Y0161		ASSY PCB PARTS(M)	MFS-FTWTHA-00	1	SA	WF316LAW,WF316BAC WF316BAW,WF306BHW WF316LAS
58	Y0161		ASSY PCB PARTS(M)	MFS-F2WLHA-T0	1	SA	WF316LAW,WF316LAS
59	Y0162		ASSY PCB PARTS(S)	MFS-F2WLHA-S0	1	SA	WF316LAW,WF316LAS
60	Z0008		SCREW-TAPPING	TH,+,2S,M4,L14,PASS,STS4	19	SA	
61	Z0013		SCREW-TAPPING	PWH,+,1,M4,L12,PASS,STS4	2	SA	WF316LAW,WF316BAC WF316BAW,WF306BHW WF316LAS,WF306LAW
62	Z0015		SCREW-TAPPING	TH,+,1,M4,L14,ZPC(YEL)	13	SC	
63	Z0046		SCREW-TAPPING	HEX,+,2,M6.5,L40,ZPC3(WH)	12	SA	WF316LAW,WF316BAC WF316BAW,WF306BHW WF316LAS,WF306LAW
64	Z0055		SCREW-TAPPING	TH,+,WE,M4,L12,ZPC3 (WHT)	22	SA	
65	Z0056		SCREW-TAPPING	TH,+,1,M4,L12,ZPC3 (WHT)	17	SA	
66	Z0062		SCREW-TAPPING	BH,+,M4,L16,ZPC(BLK)	3		WF316LAW,WF316BAC WF316BAW,WF306BHW WF316LAS,WF306LAW
67	Z0062		SCREW-TAPPING	PH,+,2S,M3,L8,ZPC(YEL),S	1	SA	WF316LAW,WF316BAC WF316BAW,WF306BHW WF316LAS
68			SCREW-TAPTITE	TH,+,S,M4,L8,ZPC3(BLK),S	6	SA	
69	C0002		ASSY-S.PANEL CONTROL	WF316LAW,WHT	1	SA	WF316LAW,WF316BAW

70	C0002		ASSY-S.PANEL CONTROL	WF306BHW,WHT	1	SA	WF306BHW
71	C0002		ASSY-S.PANEL CONTROL	WF306LAW,WHT	1	SA	WF306LAW
72	C0002		ASSY-S.PANEL CONTROL	WF316BAC,SILKY CHAM	1	SA	WF316BAC
73	C0002		ASSY-S.PANEL CONTROL	WF316LAS,IMPERIAL-S	1	SA	WF316LAS
74	R0025		ASSY-PANEL DRAWER	WF316BAW,FRONTIER	1	SA	WF316BAW,WF306BHW
75	R0025		ASSY-PANEL DRAWER	WF316LAW,FRONTIER	1	SA	WF316LAW,WF306LAW
76	R0025		ASSY-PANEL DRAWER	WF316BAC,FRONTIER	1		WF316BAC
77	R0025		ASSY-PANEL DRAWER	WF316LAS,FRONTIER	1	SA	WF316LAS
78	R0015		ASSY-S.DRAWER	MAH9700AWW	1	SA	WF316LAW,WF316BAC WF316BAW,WF316LAS
79	R0015		ASSY-S.DRAWER	WF306LAW,NO-PRE WASH	1	SA	WF306BHW,WF306LAW

## 7-2. THE DOOR PARTS

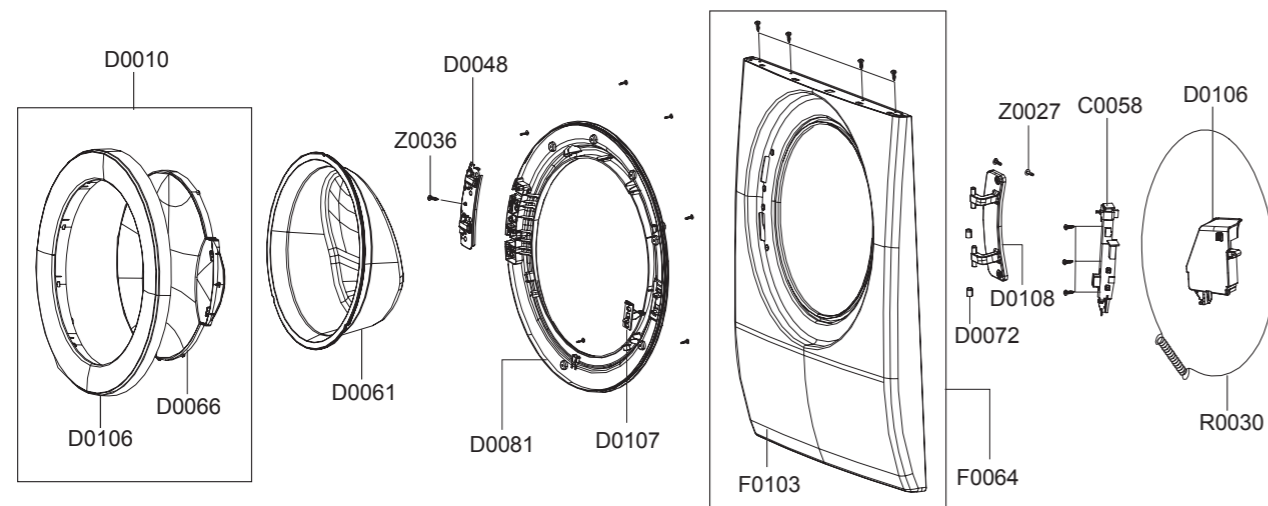

No.	SVC_Code	Code	Description	Spec	EA	SA	Remark
1	C0058		DOOR-LOCK S/W	GW-PJT,PP-GF,BLK,1	1	SA	WF316LAW,WF316BAC WF316BAW,WF306BHW WF316LAS,WF306LAW
2	D0010		ASSY-COVER DOOR	WF316BAW,SPRAY(IMPERIAL-	1	SA	WF316BAC,WF316BAW
3	D0010		ASSY-COVER DOOR	WF-G106AW,FRONTIER	1	SA	WF306BHW,WF306LAW
4	D0010		ASSY-COVER DOOR	WF326LAW,FRONTIER	1	SA	WF316LAW,WF316LAS
5	D0048		BRACKET-HINGE	WINGS-DRYER,SECC(EGI),T1.6	1	SA	WF316LAW,WF316BAC WF316BAW,WF306BHW WF316LAS,WF306LAW
6	D0061		DOOR-GLASS	TS85-PJT,BOROSILICATE	1	SC	WF316LAW,WF316BAC WF316BAW,WF306BHW WF316LAS,WF306LAW
7	D0066		DOOR-SAFETY	WF326LAW,PET,T2.8,NTR,	1	SA	WF316LAW,WF316BAC WF316BAW,WF306BHW WF316LAS,WF306LAW
8	D0072		GUIDE-HINGE	HAUZEN(DOM),POM,WHT,HI	4	SA	WF316LAW,WF316BAC WF316BAW,WF306BHW WF316LAS,WF306LAW
9	D0081		HOLDER-GLASS	WF326LAW,PP(TB53),T2.8,	1	SA	WF316LAW,WF316BAC WF316BAW,WF306BHW WF316LAS,WF306LAW
10	D0106		COVER-DOOR SWITCH	FRONTIER,PP(V0),	1	SA	WF316LAW,WF316BAC WF316BAW,WF306BHW WF316LAS,WF306LAW
11	D0106		COVER-DOOR	WF316BAW,ABS,T2.8,IMP	1	SA	WF316BAC,WF316BAW
12	D0106		COVER-DOOR	WF306LAW,ABS,T2.8,NEA	1	SA	WF306BHW,WF306LAW
13	D0106		COVER-DOOR	WF316LAW,ABS,T2.8,CR-	1		WF316LAW,WF316LAS
14	D0107		LEVER-DOOR	TS85-PJT,POM,W24,L54,WHT,	1	SA	WF316LAW,WF316BAC WF316BAW,WF306BHW WF316LAS,WF306LAW
15	D0108		HINGE-DOOR	WF326LAW,ZNDC,T3.8,FR	1	SA	WF316LAW,WF316BAC WF316BAW,WF306BHW WF316LAS,WF306LAW
16	F0064		ASSY-FRAME FRONT	WF326LAW,FRONTIER	1	SA	WF316LAW,WF316BAW WF306BHW,WF306LAW
17	F0064		ASSY-FRAME FRONT	WF316BAC,SILKY CHAMPAGN	1	SA	WF316BAC
18	F0064		ASSY-FRAME FRONT	WF326LAS,IMPERIAL-SIL	1	SA	WF316LAS
19	F0103		FRAME-FRONT	WF326LAW,SECC,WHT,T0.8,W	1		WF316LAW,WF316BAW WF306BHW,WF306LAW
20	F0103		FRAME-FRONT	WF316BAC,SECC,SILKY CHAM	1	SA	WF316BAC
21	R0030		ASSY-WIRE DIAPHRAGM	TS85-PJT,FRAME-FRONT	1	SA	WF316LAW,WF316BAC WF316BAW,WF306BHW WF316LAS,WF306LAW
22	Z0027		SCREW-MACHINE	TH,+,M5,L12,PASS,STS430,	2	SA	WF316LAW,WF316BAC WF316BAW,WF306BHW WF316LAS,WF306LAW
23	Z0036		SCREW-MACHINE	TH,+,M5,L16,PASS,STS430,FP	1	SA	WF316LAW,WF316BAC WF316BAW,WF306BHW WF316LAS,WF306LAW



### 7-3. THE TUB PARTS

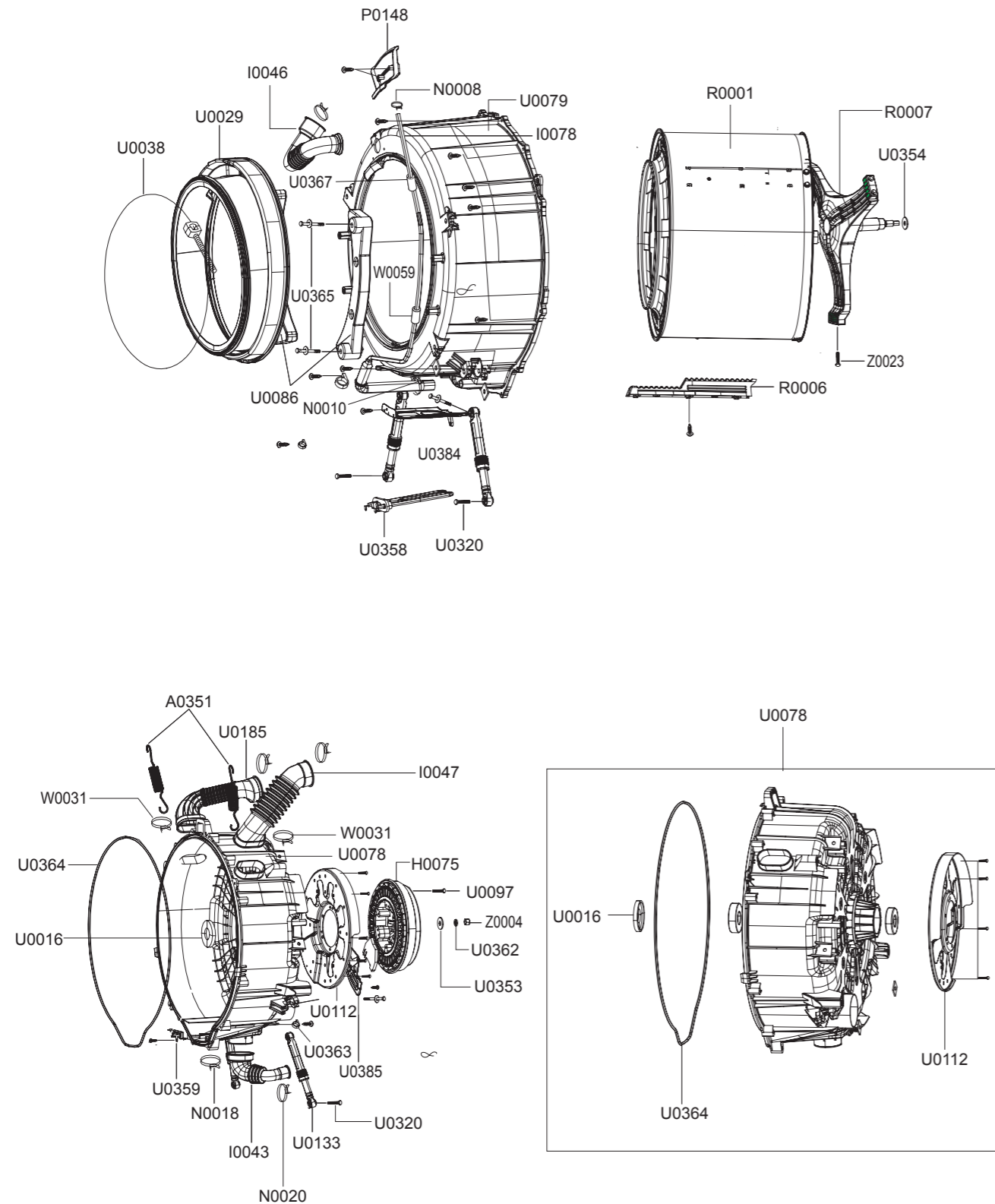

No.	SVC_Code	Code	Description	Spec	EA	SA	Remark
1	H0075		MOTOR-DRUM	NEWMOTECH,SEW-HW125,1	1	SA	WF316LAW,WF316BAC WF316BAW,WF306BHW WF316LAS,WF306LAW
2	I0043		HOSE-DRAIN	GW-PJT,EPDM,OD 68,T2.0,BL	1	SA	WF316LAW,WF316BAC WF316BAW,WF306BHW WF316LAS,WF306LAW
3	I0046		HOSE-DRAWER TUB	GW-PJT,EPDM,BLK,	1	SA	WF316LAW,WF316BAC WF316BAW,WF306BHW WF316LAS,WF306LAW
4	I0047		HOSE-O.F	GW-PJT,EPDM,T2.0,BLK	1	SA	WF316LAW,WF316BAC WF316BAW,WF306BHW WF316LAS,WF306LAW
5	I0078		HOSE-PRESSURE	GW-PJT,EPDM,BLK	1	SA	WF316LAW,WF316BAC WF316BAW,WF306BHW WF316LAS,WF306LAW
6	N0008		SPRING-CLIP	SEW-HW125,HSWR67,CD1.2,ID8.5	3	SA	
7	N0010		CLAMPER HOSE	TS85-PJT,HSWR,YEL,OD24/	1	SA	WF316LAW,WF316BAC WF316BAW,WF306BHW WF316LAS,WF306LAW
8	N0018		CLAMPER HOSE	GW-PJT,HSWR,ID82,ZPC2,HOS	1	SA	WF316LAW,WF316BAC WF316BAW,WF306BHW WF316LAS,WF306LAW
9	N0020		CLIP-HOSE	SK-5,WLSL1100A,ID35 OD37.4,ZPC	1	SA	WF316LAW,WF316BAC WF316BAW,WF306BHW WF316LAS,WF306LAW
10	P0148		GUIDE-WATER	GW-PJT,FRPP(GF15%),T2.5,	1	SA	WF316LAW,WF316BAC WF316BAW,WF306BHW WF316LAS,WF306LAW
11	R0001		ASSY-DRUM	WF326LAW,FRONTIER	1	SA	WF316LAW,WF316BAC WF316BAW,WF306BHW WF316LAS,WF306LAW
12	R0002		DRUM-FRONT	GW-PJT,STS430 H/L NO4,ID561	1		WF316LAW,WF316BAC WF316BAW,WF306BHW WF316LAS,WF306LAW
13	R0003		DRUM-WRAPPER	GW-PJT,STS430 H/L NO4,T0.6,	1		WF316LAW,WF316BAC WF316BAW,WF306BHW WF316LAS,WF306LAW
14	R0005		DRUM-BACK	GW-PJT,STS430 H/L NO4,ID561,OD	1		WF316LAW,WF316BAC WF316BAW,WF306BHW WF316LAS,WF306LAW
15	R0006		DRUM-LIFTER	WF326LAW,PP(TI42),L314,G	3	SA	WF316LAW,WF316BAC WF316BAW,WF306BHW WF316LAS,WF306LAW
16	R0007		ASSY-FLANGE SHAFT	GW-PJT,ALDC+SM45C/DD-T	1	SA	WF316LAW,WF316BAC WF316BAW,WF306BHW WF316LAS,WF306LAW
17	U0016		SEAL-OIL	TS85-PJT,NBR(SD45.5),BLK	1	SA	WF316LAW,WF316BAC WF316BAW,WF306BHW WF316LAS,WF306LAW
18	U0029		DOOR-DIAPHRAGM	GW-PJT,EPDM,T1.5,GR	1	SA	WF316LAW,WF316BAC WF316BAW,WF306BHW WF316LAS,WF306LAW
19	U0038		ASSY-CLAMP DIAPHRAGM	WINGS-PJT,HSWR/ZPC4	1	SA	WF316LAW,WF316BAC WF316BAW,WF306BHW WF316LAS,WF306LAW
20	U0078		ASSY-SEMI TUB BACK	WINGS-PJT,SAMBAK	1		WF316LAW,WF316BAC WF316BAW,WF306BHW WF316LAS,WF306LAW
21	U0079		ASSY-SEMI TUB FRONT	WINGS-PJT,SAMBAK	1	SA	WF316LAW,WF316BAC WF316BAW,WF306BHW WF316LAS
22	U0086		WEIGHT-BALANCER(F)	GW-PJT,GC,RED,F	2	SA	WF316LAW,WF316BAC WF316BAW,WF306BHW WF316LAS,WF306LAW
23	U0097		BOLT-ETC	M6,L56,ZPC3(WHT),SWRCH10A, P1.0	6	SA	WF316LAW,WF316BAC WF316BAW,WF306BHW WF316LAS,WF306LAW

### 7-3. THE TUB PARTS

No.	SVC_Code	Code	Description	Spec	EA	SA	Remark
24	U0112		BRACKET-HOUSING BEARING	GW-PJT,SBHG1-A(G	1	SA	WF316LAW,WF316BAC WF316BAW,WF306BHW WF316LAS,WF306LAW
25	U0133		DAMPER-SHOCK	GW-PJT,60N	2	SA	WF316LAW,WF316BAC WF316BAW,WF306BHW WF316LAS,WF306LAW
26	U0185		HOSE-O.F(I)	WINGS-PJT,EPDM,T2.0,BL	1	SA	WF316LAW,WF316BAC WF316BAW,WF306BHW WF316LAS,WF306LAW
27	U0320		BOLT-HEX	M6,L35.1,ZPC3(YEL),SWCH25K,T APP	3	SA	WF316LAW,WF316BAC WF316BAW,WF306BHW WF316LAS,WF306LAW
28	U0320		BOLT-HEX	M10,L41,ZPC3(WHT),SM10C	4	SA	WF316LAW,WF316BAC WF316BAW,WF306BHW WF316LAS,WF306LAW
29	U0320		BOLT-HEX	M8,L66,ZPC3(WHT),SM10C	4	SA	
30	U0353		WASHER-PLAIN	SCP1,ID7,OD14,T0.8,ZPC2(Y	1	SA	WF316LAW,WF316BAC WF316BAW,WF306BHW WF316LAS,WF306LAW
31	U0353		WASHER-PLAIN	ID10.5,OD30,T3,STS304	5	SA	
32	U0354		WASHER-WAVE	SK5,ID35,OD45,T0.6,ZPC2	1	SA	WF316LAW,WF316BAC WF316BAW,WF306BHW WF316LAS,WF306LAW
33	U0358		HEATER	GW-PJT,STS316L,1000W,7.92~8.	1	SA	WF316LAW,WF316BAC WF316BAW,WF306BHW WF316LAS
34	U0359		BRACKET-HEATER	GW-PJT,STS430/304,T0.5,W9	1	SA	WF316LAW,WF316BAC WF316BAW,WF306BHW WF316LAS
35	U0362		WASHER-SPRING	ID10.5,OD18,T2.5,SIR	1	SA	WF316LAW,WF316BAC WF316BAW,WF306BHW WF316LAS,WF306LAW
36	U0363		CABLE CLAMP	DA-8N,NYLON#66,NTR,ID13.	1	SA	WF316LAW,WF316BAC WF316BAW,WF306BHW WF316LAS,WF306LAW
37	U0363		CABLE CLAMP	DAWH-18NB,ID15,NYLON66,NTR	5	SA	WF316LAW,WF316BAC WF316BAW,WF306BHW WF316LAS,WF306LAW
38	U0364		PACKING-TUB	GW-PJT,EPDM-FORM,PI8,W624,	1	SA	WF316LAW,WF316BAC WF316BAW,WF306BHW WF316LAS,WF306LAW
39	U0365		ASSY-BOLT	MAH2400AWW,MOTOR/M8*L62	4	SA	WF316LAW,WF316BAC WF316BAW,WF306BHW WF316LAS,WF306LAW
40	U0367		SPONGE-HOSE AIR	GW-PJT,HB22-GREY,T130,	1	SA	WF316LAW,WF316BAC WF316BAW,WF306BHW WF316LAS,WF306LAW
41	U0384		BRACKET-TUB(F)	WINGS-PJT,SBHG1-A,T0.4,	1	SA	WF316LAW,WF316BAC WF316BAW,WF306BHW WF316LAS
42	U0385		BRACKET-TUB(B)	WINGS-PJT,SBHG1-A,T0.4,	1	SA	WF316LAW,WF316BAC WF316BAW,WF306BHW WF316LAS,WF306LAW
43	W0031		BAND-RING	WINGS-PJT,HSWR,T4,YEL,HOSE	2	SA	WF316LAW,WF316BAC WF316BAW,WF306BHW WF316LAS,WF306LAW
44	W0031		BAND-RING	WINGS-PJT,HSWR,T2.4,YEL,ID	2	SA	WF316LAW,WF316BAC WF316BAW,WF306BHW WF316LAS,WF306LAW
45	W0031		BAND-RING	DRUM-MODEL,HSWR,,YEL,ID6	1	SA	WF316LAW,WF316BAC WF316BAW,WF306BHW WF316LAS,WF306LAW

46	W0059		SPONGE-HARNESS	PU-FOAM,T10,W100,L80,	1	SA	WF316LAW,WF316BAC WF316BAW,WF306BHW WF316LAS,WF306LAW
47	Z0004		NUT-HEX	SM20C(NYLON),M12,ZPC3(YEL)	1	SA	WF316LAW,WF316BAC WF316BAW,WF306BHW WF316LAS,WF306LAW
48	Z0023		BOLT-FLANGE	M8,L38.5,PASS,STS304,P1.25,H	6	SA	WF316LAW,WF316BAC WF316BAW,WF306BHW WF316LAS,WF306LAW
49			WIRE-VINYL	SEW-100JL,PVC,T2.0*L150	7		

## 7-4. THE FRAME PARTS

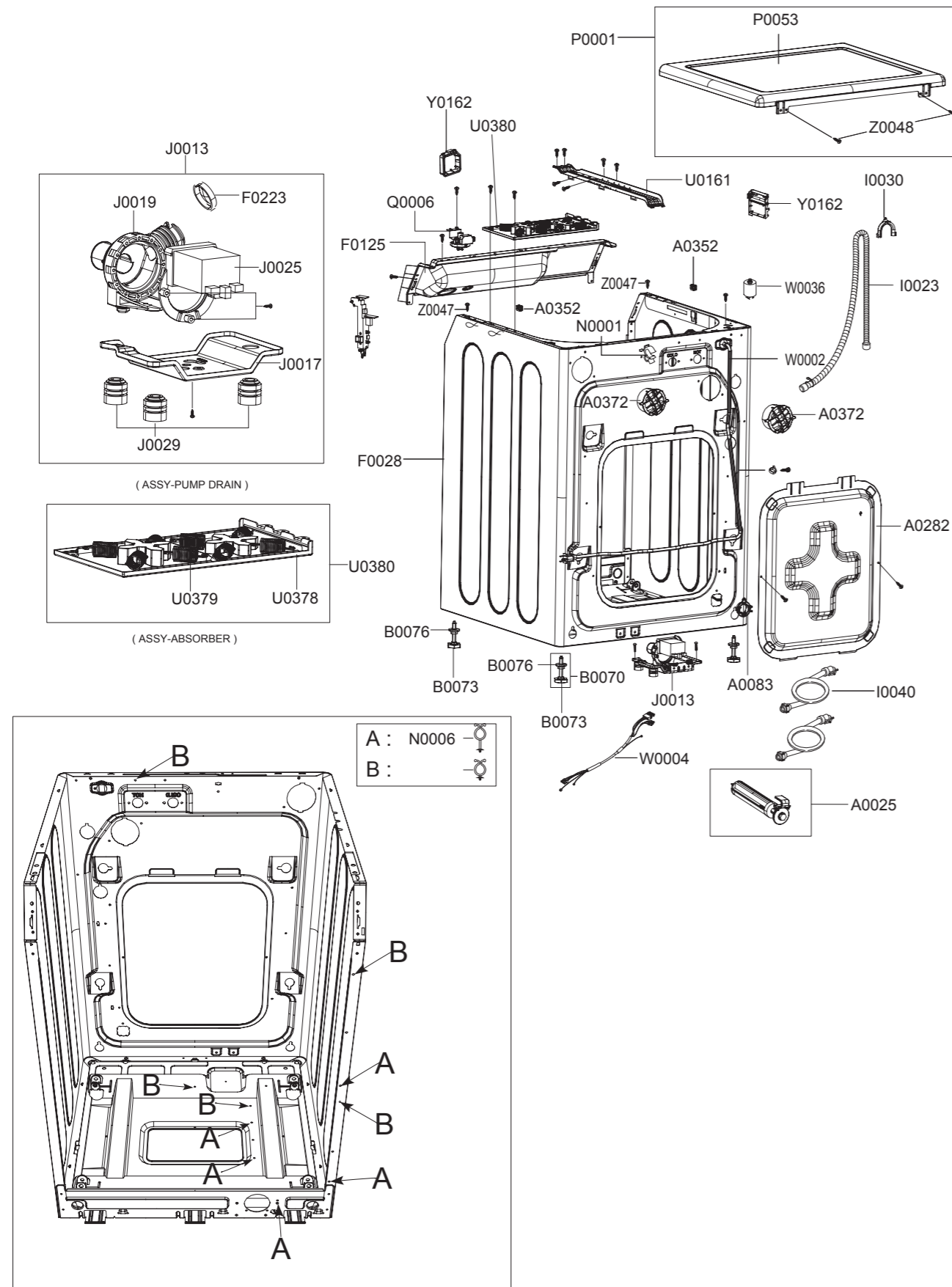

No.	SVC_Code	Code	Description	Spec	EA	SA	Remark
1	A0025		ASSY-FIXER TUB	GW-PJT,POWER CORD	4	SA	WF316LAW,WF316BAC WF316BAW,WF306BHW WF316LAS,WF306LAW
2	A0047		CAP-O.F	GW-PJT,PP(FC2210-G246),T2.8,	1		WF316LAW,WF316BAC WF316BAW,WF306BHW WF316LAS,WF306LAW
3	A0083		GUIDE-HOSE	P/PV/M,PP,WHT,FRAME/DRA	1	SA	WF316LAW,WF316BAC WF316BAW,WF306BHW WF316LAS,WF306LAW
4	A0282		COVER-BACK	GW-PJT,GI,T0.4,W426,L507,	1	SA	WF316LAW,WF316BAC WF316BAW,WF306BHW WF316LAS,WF306LAW
5	A0352		GUIDE-SPRING	GW-PJT,POM,NTR	2		WF316LAW,WF316BAC WF316BAW,WF306BHW WF316LAS,WF306LAW
6	A0372		ASSY-CAP O.F	GW-PJT,SUDS	2	SA	WF316LAW,WF316BAC WF316BAW,WF306BHW WF316LAS,WF306LAW
7	B0070		ASSY-LEG	MAH9700AWW,GRY/BUTYL+BOLT	4	SA	WF316LAW,WF316BAC WF316BAW,WF306BHW WF316LAS,WF306LAW
8	B0073		LEG-RUBBER	MAH9700AWW,BUTYL,GRY,WING	1		WF316LAW,WF316BAC WF316BAW,WF306BHW WF316LAS,WF306LAW
9	B0076		NUT-HEXAGON FLANGE	1C,M10,ZPC(YEL),SCP-1	1		WF316LAW,WF316BAC WF316BAW,WF306BHW WF316LAS,WF306LAW
10	F0028		ASSY-FRAME	GW-PJT,H+COLD	1	SA	WF316LAW,WF316BAW WF306BHW,WF306LAW
11	F0028		ASSY-FRAME	WF316BAC,SILKY CHAMPAGNE/T1.0	1	SA	WF316BAC
12	F0028		ASSY-FRAME	WF316LAS,IMPERIAL-SIL/T1.0	1	SA	WF316LAS
13	F0066		ASSY-PLATE BOTTOM	GW-PJT,SBHG1-A/T1.6	1		WF316LAW,WF316BAC WF316BAW,WF306BHW WF316LAS,WF306LAW
14	F0079		BRACKET-SPRING(L)	WINGS-PJT,SBHG1-A,T1.6	1		WF316LAW,WF316BAC WF316BAW,WF306BHW WF316LAS,WF306LAW
15	F0094		FRAME	WINGS-PJT,PCM,WHT,T1.0	1		WF316LAW,WF316BAW WF306BHW,WF306LAW
16	F0094		FRAME	WF316BAC,PCM(GI),SILKY CHA	1		WF316BAC
17	F0094		FRAME	WF316LAS,PCM(GI),IMPERIAL-	1		WF316LAS
18	F0125		FRAME-PLATE(U)	GW-PJT,EGI,T1.6	1	SA	WF316LAW,WF316BAC WF316BAW,WF306BHW WF316LAS,WF306LAW
19	F0223		VALVE-CHECK	WINGS,EPDM,PO30,1~10BAR,BLK,	1	SA	WF316LAW,WF316BAC WF316BAW,WF306BHW WF316LAS,WF306LAW
20	I0023		ASSY-HOSE DRAIN(I)	MAH9700AWW,WINGS-PJT	1	SA	WF316LAW,WF316BAC WF316BAW,WF306BHW WF316LAS,WF306LAW
21	I0030		HOSE-HANGER	PP(JS20),NTR	1	SA	WF316LAW,WF306BHW WF316LAS,WF306LAW
22	I0040		ASSY-HOSE WATER	GW-PJT,COLD	1	SC	WF316LAW,WF306BHW WF316LAS,WF306LAW
23	I0040		ASSY-HOSE WATER	GW-PJT,HOT	1	SC	WF316LAW,WF306BHW WF316LAS,WF306LAW
24	J0013		ASSY-PUMP DRAIN	WINGS-PJT,80W(120V/60Hz)	1	SA	WF316LAW,WF316BAC WF316BAW,WF306BHW WF316LAS,WF306LAW

## 7-4. THE FRAME PARTS

No.	SVC_Code	Code	Description	Spec	EA	SA	Remark
25	J0017		BRACKET-PUMP	WINGS-PJT,GA,T1.2,W185,L115	1	SA	WF316LAW,WF316BAC WF316BAW,WF306BHW WF316LAS,WF306LAW
26	J0019		CASE-PUMP	WINGS-PJT,PP(5113MF6),T3,W110,	1		WF316LAW,WF316BAC WF316BAW,WF306BHW WF316LAS,WF306LAW
27	J0025		PUMP-DRAIN	120V,60Hz,40mm,80W/3600RPM	1		WF316LAW,WF316BAC WF316BAW,WF306BHW WF316LAS,WF306LAW
28	J0029		CUSHION-PUMP	MAH9700AWW,EPDM,WIN	1	SA	WF316LAW,WF316BAC WF316BAW,WF306BHW WF316LAS,WF306LAW
29	N0006		HOLDER-WIRE	DAWH-2NC,NYLON66,NTR	5	SA	WF316LAW,WF316BAC WF316BAW,WF306BHW WF316LAS,WF306LAW
30	P0001		ASSY-COVER TOP	GW-PJT	1	SA	WF316LAW,WF316BAW WF306BHW,WF306LAW
31	P0001		ASSY-COVER TOP	WF316BAC,SILKY CHAMPAGNE	1	SA	WF316BAC
32	P0001		ASSY-COVER TOP	WF326LAS,IMPERIAL-SIL	1	SA	WF316LAS
33	P0053		COVER-TOP	GW-PJT,SECC(EGI),T1.0,W684,L56	1		WF316LAW,WF316BAW WF306BHW,WF306LAW
34	P0053		COVER-TOP	WF316BAC,SBHG1-A,T1.0,W684,L56	1	SA	WF316BAC
35	P0053		COVER-TOP	WF326LAS,SBHG1-A,T1.0,W684,L56	1		WF316LAS
36	Q0006		ASSY-SENSOR PRESSURE	SEW-3HW123,DN-S14T/	1	SA	WF316LAW,WF316BAC WF316BAW,WF306BHW WF316LAS,WF306LAW
37	U0161		GUIDE-WIRE	GW-PJT,SBHG1-A,T1.0,W52,NTR	1	SA	WF316LAW,WF316BAC WF316BAW,WF306BHW WF316LAS,WF306LAW
38	U0364		BRACKET-SPRING(R)	WINGS-PJT,SBHG1-A,T1.6	1		WF316LAW,WF316BAC WF316BAW,WF306BHW WF316LAS,WF306LAW
39	U0378		BRACKET-ABSORBER	GW27,SBHG1-A,T1.0,W170,	1		WF316LAW,WF316BAC WF316BAW,WF306BHW WF316LAS,WF306LAW
40	U0379		SPRING-ABSORBER	GW-PJT,SWC,CD2,ID16,OD20	4		WF316LAW,WF316BAC WF316BAW,WF306BHW WF316LAS,WF306LAW
41	U0380		ASSY-ABSORBER	FRONTIER,970/1080	1	SA	WF316LAW,WF316BAC WF316BAW,WF316LAS
42	W0002		ASSY POWER CORD	GW-PJT,GW,UL/CSA,3/16AWG	1	SA	WF316LAW,WF316BAC WF316BAW,WF306BHW WF316LAS,WF306LAW
43	W0004		ASSY-M.WIRE HARNESS	WF326LAW,SILVER KIT	1	SA	WF316LAW,WF316BAC WF316BAW,WF316LAS
44	W0036		FILTER-EMI	LFT-215G,WINGS_PJT,250VAC,15A	1	SA	WF316LAW,WF316BAC WF316BAW,WF306BHW WF316LAS,WF306LAW
45	Y0162		ASSY PCB PARTS(S)	MES-MEMS-00	1	SA	WF316LAW,WF316BAC WF316BAW,WF306BHW WF316LAS,WF306LAW
46	Y0162		ASSY PCB PARTS(S)	MES-AG3MOD-S2	1	SA	WF316LAW,WF316BAC WF316BAW,WF306BHW WF316LAS,WF306LAW
47	Z0047		SCREW-SPECIAL	CH,+,M4,L10,ZPC3(BLK),SW	2	SA	WF316LAW,WF316BAC WF316BAW,WF306BHW WF316LAS,WF306LAW
48	Z0048		SCREW-HEX	HEX,+,M5,L10,ZPC3(BLK),SWRCH	3	SA	
49			WEIGHT-ABSORBER	GW-PJT,ZNDC,WEIGHT390G	1		WF316LAW,WF316BAC WF316BAW,WF306BHW WF316LAS,WF306LAW
50			WEIGHT-ABSORBER	GW-PJT,ZNDC,WEIGHT305G	1		WF316LAW,WF316BAC WF316BAW,WF316LAS



## 7-5. PARTS LIST(SA)

SVC Code	Code	Description	Spec	EA	SA	Remark
1	A0034	BOLT-SPANNER	OD36,T2.5,L52,FE,FZY,P	1	SA	WF316LAW,WF306BHW WF316LAS,WF306LAW
2	A0043	AP-FIXER	SWF-P12,PP(TB53),WHT,	6	SA	WF316LAW,WF306BHW WF316LAS,WF306LAW
3	A0125	STAND OFF	ID11.5,L2,NTR,NYLON66,DAWH-3NA	3	SA	WF316LAW,WF316BAC WF316BAW,WF306BHW WF316LAS,WF306LAW
4	C0043	BUTTON-PUSH(F)	WF316BAC,ABS,SILKY CH	1	SA	WF316BAC
5	C0044	BUTTON-PUSH(P)	WF316BAC,ABS,SILKY CH	1	SA	WF316BAC
6	C0044	BUTTON-PUSH(P)	WF326LAS,ABS,IMPERIAL	1	SA	WF316LAS
7	D0111	SPONGE-EPDM	MAH2400,EPDM,T1,W15,L500,W	3	SA	WF316LAW,WF316BAC WF316BAW,WF306BHW WF316LAS,WF306LAW
8	I0044	ASSY-HOSE PRESSURE	WF316LAW,FRONTIER	1	SA	WF316LAW,WF316BAC WF316BAW,WF306BHW WF316LAS
9	R0019	ASSY-HOUSING DRAWER	MAH8700AGW,INTERNATI	1	SA	WF306BHW,WF306LAW
10	R0155	HANDLE-DRAWER	WF316BAC,ABS,SILKY	1	SA	WF316BAC
11	R0155	HANDLE-DRAWER	WF326LAS,ABS,IMPER	1	SA	WF316LAS
12	U0026	ASSY-TUB FRONT	MAH8700AGW,INTERNATIONAL	1	SC	WF316LAW,WF316BAC WF316BAW,WF306BHW WF316LAS
13	U0079	ASSY-SEMI TUB FRONT	MAH8700AGW,INTERNATI	1	SA	WF306LAW
14	U0133	DAMPER-SHOCK	GW-PJT,STEEL+PP+RUBBER,40N,	2	SA	WF316LAW,WF316BAC WF316BAW,WF306BHW WF316LAS,WF306LAW
15	U0380	ASSY-ABSORBER	GW-PJT,DVA/MW27 ENTRY	1	SA	WF306BHW,WF306LAW
16	W0004	ASSY-M.WIRE HARNESS	WF306BAC,2WAY VALVE	1	SA	WF306BHW
17	W0004	ASSY-M.WIRE HARNESS	FRONTIER,NO HEATER	1	SA	WF306LAW
18	W0035	THERMISTOR	11982OHM AT 25°C5~155,	1	SA	WF306LAW
19	W0063	PACKING-THERMISTOR	GW-PJT,EPDM,W17	1	SA	WF306LAW
20	X0050	GUIDE-CUSHION	MAH98700AWW,PP,T2.8,	1	SA	WF316LAW,WF316BAC WF316BAW,WF306BHW WF316LAS,WF306LAW
21	Y0161	ASSY PCB PARTS(M)	MFS-F2WBHA-T0	1	SA	WF316BAC,WF316BAW
22	Y0161	ASSY PCB PARTS(M)	MFS-F8WBHA-T0	1	SA	WF306BHW
23	Y0161	ASSY PCB PARTS(M)	MFS-F3WLA-T0	1	SA	WF306LAW
24	Y0162	ASSY PCB PARTS(S)	MFS-F2WBHA-S0	1	SA	WF316BAC,WF316BAW
25	Y0162	ASSY PCB PARTS(S)	MFS-F8WBHA-S0	1	SA	WF306BHW
26		ASSY-CUSHION PUMP	MAH9700AWW,WINGS-WASHE	3	SA	WF316LAW,WF316BAC WF316BAW,WF306BHW WF316LAS,WF306LAW
27		ASSY-HINGE DOOR	FRONTIER-PJT,SINGLE	1	SA	WF316LAW,WF316BAC WF316BAW,WF306BHW WF316LAS,WF306LAW
28		ASSY-GUIDE WIRE	FRONTIER-PJT,HOLDER CHAN	1	SA	WF316LAW,WF316BAC WF316BAW,WF306BHW WF316LAS,WF306LAW
29		PCB-SUB	FRONTIER,FR-1,NL 1,T1.6,197x	1	SA	WF316LAW,WF316BAC WF316BAW,WF306BHW WF316LAS
30		COVER-DRAWER	WF326LAS,ABS,IMPE	1	SA	WF316LAS
31		GUIDE-LED(B)	WF-G106AW,HIPS,NTR,FR	1	SA	WF306BHW



## 8. ELECTRICAL PARTS LIST

-You can search for updated part codes through ITSELF web site.

URL : <http://itself.sec.samsung.co.kr/>

Level	CODE NO.	DESCRIPTION	SPECIFICATION	QTY	SVC-Code	SA
..2		SCREW-MACHINE	TH,+,-,M5,L12,PASS,STS430,	2	Z0027	SA
..2		SCREW-TAPPING	TH,+,-,2S,M4,L14,PASS,STS4	3	Z0008	SA
..2		SCREW-TAPPING	TH,+WE,-,M4,L12,ZPC3 (WHT	6	Z0055	SA
..2		SCREW-TAPPING	TH,+,-,1,M4,L12,ZPC3 (WHT)	4	Z0056	SA
..2		SCREW-TAPTITE	TH,+,-,S,M4,L8,ZPC3(BLK),S	2		SA
..2		SCREW-HEX	HEX,+,-,M5,L10,ZPC3(BLK),SWRCH	2	Z0048	SA
..2		COVER-BACK	GW-PJT,GI,T0.4,W426,L507,-,-,	1	A0282	SA
..2		ASSY-WIRE DIAPHRAGM	TS85-PJT,FRAME-FRONT	1	R0030	SA
..2		ASSY-FIXER TUB	GW-PJT,POWER CORD	4	A0025	SA
..2		ASSY-COVER TOP	GW-PJT,-	1	P0001	SA
..2		ASSY-DRAWER	WF316LAW,NEAT-WHT	1	R0014	SA
...3		GUIDE-LIQUID	GW-PJT,ABS,-,-,-,WHT,-	1	R0085	SA
...3		CAP-RINSE	MAH9700,PP(TB53),-,-,-,MUNSELL	1	R0157	SA
..2		ASSY-FRAME FRONT	WF326LAW,FRONTIER	1	F0064	SA
...3		BRACKET-HINGE	WINGS-DRYER,SECC(EGI),T1.6	1	D0048	SA
...3		SPONGE-EPDM	MAH2400,EPDM,-,T1,W15,L500,W	3	D0111	SA
...3		ASSY-COVER DOOR	WF326LAW,FRONTIER	1	D0010	SA
....4		DOOR-SAFETY	WF326LAW,PET,T2.8,-,-,-,NTR,	1	D0066	SA
...3		SCREW-TAPPING	TH,+,-,2S,M4,L14,PASS,STS4	11	Z0008	SA
...3		SCREW-TAPPING	PWH,+,-,1,M4,L12,PASS,STS4	2	Z0013	SA
...3		SCREW-HEX	HEX,+,-,M5,L10,ZPC3(BLK),SWRCH	1	Z0048	SA
...3		HOLDER-GLASS	WF326LAW,PP(TB53),T2.8,-,-,	1	D0081	SA
...3		LEVER-DOOR	TS85-PJT,POM,-,W24,L54,-,WHT,	1	D0107	SA
....4		GUIDE-HINGE	HAUZEN(DOM),POM,-,-,-,WHT,HI	4	D0072	SA
....4		HINGE-DOOR	WF326LAW,ZNDC,T3.8,-,-,-,FR	1	D0108	SA
...3		BUTTON-ENCODER	WF326LAW,ABS,-,-,WHT,FRON	1	C0105	SA
...3		ASSY-KNOB ENCODER	FRONTIER,LOWES	1	C0029	SA
....4		ASSY PCB PARTS(S)	MFS-F13DL-S0 FRONTIER	1	Y0162	SA
....5		PCB-SUB	FRONTIER,FR-1,NL 1,-,T1.6,197x	1		SA
...3		ASSY-S.PANEL CONTROL	WF316LAW,WHT	1		SA
....4		BUTTON-PUSH(P)	WF326LAW,ABS,-,-,WHT,FRON	1	C0044	SA
....4		LEVER-POWER	GW-PJT,POM,-,-,-,NTR,ENTRY	1	C0108	SA
...3		ASSY PCB PARTS(M)	MFS-F2WLHA-T0	1	Y0161	SA
....4		ASSY PCB PARTS(S)	MFS-F2WLHA-S0	1	Y0162	SA
....5		PCB-SUB	FRONTIER,FR-1,NL 1,-,T1.6,197x	1		SA
....4		ASSY PCB PARTS(M)	MFS-FTWTHA-00	1	Y0161	SA
....5		SCREW-TAPPING	PH,+,-,2S,M3,L8,ZPC(YEL),S	1	Z0062	SA
...3		GUIDE-CUSHION	MAH98700AWW,PP,T2.8,-,-,-,	1	X0050	SA
..2		SCREW-TAPPING	TH,+WE,-,M4,L12,ZPC3 (WHT	15	Z0055	SA
..2		SCREW-TAPPING	TH,+,-,1,M4,L12,ZPC3 (WHT)	5	Z0056	SA
..2		SCREW-TAPTITE	TH,+,-,S,M4,L8,ZPC3(BLK),S	4		SA
..2		SCREW-SPECIAL	CH,+,-,M4,L10,ZPC3(BLK),SW	2	Z0047	SA
..2		BOLT-HEX	M10,L41,ZPC3(WHT),SM10C,-	4	U0320	SA
..2		FILTER-EMI	LFT-215G,WINGS PJT,250VAC,15A	1	W0036	SA
..2		FRAME-PLATE(U)	GW-PJT,EGI,-,-,-,T1.6,-,-	1	F0125	SA
..2		DOOR-LOCK S/W	GW-PJT,PP-GF,-,-,-,BLK,1	1	C0058	SA
..2		ASSY-HOUSING DRAWER	WF326LAW,FRONTIER	1	R0019	SA
...3		CLAMPER HOSE	SEW-DR605,SK5,-,-,YEL,ID14.	10	N0009	SA
...3		HOSE-DRAWER	Q1636GW/XEU,EPDM,ID9.0,OD14.	1.48	R0158	SA
...3		HOUSING-DRAWER(L)	WF326LAW,PP(TB-53),-,-	1	R0096	SA
...3		SPRING-CLIP	SEW-HW125,HSWR67,CD1.2,ID8.5	2	N0008	SA
...3		VALVE-WATER	GW-PJT,NYLON,3WAY,MAX 10BAR,	1	W0032	SA
...3		VALVE-WATER	GW-PJT,NYLON,-,MAX10BAR,NTR,	1	W0032	SA
...3		HOSE-WATER	WF326LAW,EPDM,ID5,OD9,T2,L190	1	I0003	SA
...3		ASSY-S.HOUSING DRAWER	MAH9700AWW,-	1	R0159	SA
...3		HOLDER-WIRE SADDLE	-,NYLON66,-,-,-,NTR,D	3	M0048	SA
...3		GUIDE-WIRE	GW-PJT,SBHG1-A,T1.0,W52,-,NTR	1	U0161	SA
..2		ASSY-ABSORBER	FRONTIER,970/1080	1	U0380	SA
..2		ASSY PCB PARTS(S)	MES-AG3MOD-S2	1	Y0162	SA

## 8. ELECTRICAL PARTS LIST

Level	CODE NO.	DESCRIPTION	SPECIFICATION	QTY	SVC_Code	SA
..2		ASSY PCB PARTS(S)	MES-MEMS-00	1	Y0162	SA
..2		COVER-DOOR SWITCH	FRONTIER,PP(V0),-,-,-,	1	D0106	SA
..2		SCREW-TAPPING	HEX,+,-,2,M6.5,L40,ZPC3(WH	12	Z0046	SA
..2		SCREW-TAPPING	TH,+,-,WE,-,M4,L12,ZPC3 (WHT	1	Z0055	SA
..2		BOLT-ETC	M6,L56,ZPC3(WHT),SWRCH10A,P1.0	6	U0097	SA
..2		WASHER-WAVE	SK5,-,ID35,OD45,T0.6,ZPC2,-	1	U0354	SA
..2		MOTOR-DRUM	NEWMOTECH,SEW-HW125,-,-,-,-,1	1	H0075	SA
..2		HEATER	-,GW-PJT,STS316L,1000W,7.92~8.	1	U0358	SA
..2		NUT-HEX	SM20C(NYLON),M12,-,-,ZPC3(YEL)	1	Z0004	SA
..2		WASHER-PLAIN	-,ID10.5,OD30,T3,-,STS304	1	U0353	SA
..2		WASHER-SPRING	-,ID10.5,OD18,T2.5,-,SIR	1	U0362	SA
..2		WEIGHT-BALANCER(F)	GW-PJT,GC,-,-,-,RED,F	2	U0086	SA
..2		ASSY-BOLT	MAH2400AWW,MOTOR/M8*L62	4	U0365	SA
..2		ASSY-SENSOR PRESSURE	SEW-3HW123,DN-S14T/	1	Q0006	SA
...3		SCREW-TAPPING	TH,+,-,2S,M4,L14,PASS,STS4	1	Z0008	SA
...3		SCREW-TAPPING	TH,+,-,1,M4,L12,ZPC3 (WHT)	1	Z0056	SA
...3		BOLT-HEX	M8,L66,ZPC3(WHT),SM10C,-	2	U0320	SA
...3		WASHER-PLAIN	-,ID10.5,OD30,T3,-,STS304	2	U0353	SA
...3		CLIP-HOSE	SK-5,WLSL1100A,ID35 OD37.4,ZPC	1	N0020	SA
...3		BRACKET-HOUSING BEARING	GW-PJT,SBHG1-A(G)	1	U0112	SA
...3		SEAL-OIL	TS85-PJT,NBR(SD45.5),BLK,-,-,-	1	U0016	SA
...3		CLAMPER HOSE	GW-PJT,HSWR,-,ID82,ZPC2,HOS	1	N0018	SA
...3		CABLE CLAMP	DA-8N,NYLON#66,-,-,NTR,ID13.	1	U0363	SA
...3		HOSE-O.F	GW-PJT,EPDM,-,-,T2.0,-,BLK,-	1	I0047	SA
...3		HOSE-DRAIN	GW-PJT,EPDM,OD 68,-,T2.0,-,BL	1	I0043	SA
...3		HOSE-O.F(I)	WINGS-PJT,EPDM,-,-,T2.0,-,BL	1	U0185	SA
...3		PACKING-TUB	GW-PJT,EPDM-FORM,-,PI8,W624,	1	U0364	SA
...3		BAND-RING	WINGS-PJT,HSWR,T2.4,-,-,YEL,ID	2	W0031	SA
...3		BAND-RING	WINGS-PJT,HSWR,T4,-,-,YEL,HOSE	2	W0031	SA
...3		BRACKET-TUB(B)	WINGS-PJT,SBHG1-A,T0.4,-,	1	U0385	SA
...3		BRACKET-HEATER	GW-PJT,STS430/304,T0.5,W9	1	U0359	SA
...3		DAMPER-SHOCK	SEW-HW125,-,-,-,-,-,30-50	2	U0133	SA
..2		ASSY-DRUM	WF326LAW,FRONTIER	1	R0001	SA
...3		SCREW-TAPPING	TH,+,-,2S,M4,L14,PASS,STS4	3	Z0008	SA
...3		BOLT-FLANGE	M8,L38.5,PASS,STS304,P1.25,H	6	Z0023	SA
...3		DRUM-LIFTER	WF326LAW,PP(TI42),-,-,L314,G	3	R0006	SA
...3		ASSY-FLANGE SHAFT	GW-PJT,ALDC+SM45C/DD-T	1	R0007	SA
...3		SCREW-TAPPING	TH,+,-,2S,M4,L14,PASS,STS4	2	Z0008	SA
...3		SCREW-TAPPING	TH,+,-,1,M4,L12,ZPC3 (WHT)	3	Z0056	SA
...3		BOLT-HEX	M8,L66,ZPC3(WHT),SM10C,-	2	U0320	SA
...3		WASHER-PLAIN	-,ID10.5,OD30,T3,-,STS304	2	U0353	SA
...3		GUIDE-WATER	GW-PJT,FRPP(GF15%),T2.5,-,-,	1	P0148	SA
...3		SPRING-CLIP	SEW-HW125,HSWR67,CD1.2,ID8.5	1	N0008	SA
...3		SPONGE-HARNESS	-,PU-FOAM,-,T10,W100,L80,	1	W0059	SA
...3		DOOR-DIAPHRAGM	GW-PJT,EPDM,T1.5,-,-,-,GR	1	U0029	SA
...3		CLAMPER HOSE	TS85-PJT,HSWR,-,-,YEL,OD24/	1	N0010	SA
...3		DAMPER-SHOCK	GW-PJT,-,-,-,-,-,60N	2	U0133	SA
...3		HOSE-DRAWER TUB	GW-PJT,EPDM,-,-,-,-,BLK,	1	I0046	SA
...3		BAND-RING	DRUM-MODEL,HSWR,-,-,-,-,YEL,ID6	1	W0031	SA
....4		HOSE-PRESSURE	GW-PJT,EPDM,-,-,-,-,BLK,-	1	I0078	SA
...3		ASSY-SEMI TUB FRONT	WINGS-PJT,SAMBAK	1	U0079	SA
...3		BRACKET-TUB(F)	WINGS-PJT,SBHG1-A,T0.4,-,	1	U0384	SA
...3		SPONGE-HOSE AIR	GW-PJT,HB22-GREY,-,T130,	1	U0367	SA
...3		ASSY-CLAMP DIAPHRAGM	WINGS-PJT,HSWR/ZPC4	1	U0038	SA
...3		BOLT-SPANER	-,OD36,T2.5,L52,FE,FZY,-,P	1	A0034	SA
...3		CAP-FIXER	SWF-P12,PP(TB53),-,-,-,WHT,-,	6	A0043	SA
...3		HOSE-HANGER	-,PP(JS20),-,-,-,-,NTR,-	1	I0030	SA
..2		SCREW-TAPPING	TH,+,-,1,M4,L12,ZPC3 (WHT)	1	Z0056	SA
..2		BOLT-HEX	M6,L35.1,ZPC(YEL),SWCH25K,TAPP	3	U0320	SA

## 8. ELECTRICAL PARTS LIST

Level	CODE NO.	DESCRIPTION	SPECIFICATION	QTY	SVC-Code	SA
..2		SCREW-TAPPING	TH,+,-,1,M4,L12,ZPC3 (WHT)	1	Z0056	SA
..2		BOLT-HEX	M6,L35.1,ZPC(YEL),SWCH25K,TAPP	3	U0320	SA
..2		CABLE CLAMP	DAWH-18NB,ID15,-,NYLON66,NTR	5	U0363	SA
..2		GUIDE-HOSE	P/PV/M,PP,-,-,-,WHT,FRAME/DRA	1	A0083	SA
..2		SPRING-HANGER	GW-PJT,HSWR,4,ID26,OD30,L2	2	A0351	SA
..2		HOLDER-WIRE	DAWH-2NC,NYLON66,-,-,-,NTR	5	N0006	SA
..2		ASSY POWER CORD	GW-PJT,GW,UL/CSA,3/16AWG	1	W0002	SA
..2		ASSY-PUMP DRAIN	WINGS-PJT,80W(120V/60Hz)	1	J0013	SA
...3		SCREW-TAPPING	TH,+,-,1,M4,L12,ZPC3 (WHT)	1	Z0056	SA
...3		VALVE-CHECK	WINGS,EPDM,PO30,1~10BAR,BLK,	1	F0223	SA
...3		BRACKET-PUMP	WINGS-PJT,GA,T1.2,W185,L115	1	J0017	SA
...3		ASSY-CUSHION PUMP	MAH9700AWW,WINGS-WASHE	3		SA
....4		WASHER-PLAIN	SCP1,-,ID7,OD14,T0.8,ZPC2(Y	1	U0353	SA
....4		CUSHION-PUMP	MAH9700AWW,EPDM,-,-,-,WIN	1	J0029	SA
..2		ASSY-M.WIRE HARNESS	WF326LAW,SILVER KIT	1	W0004	SA
..2		ASSY-FRAME	GW-PJT,H+COLD	1	F0028	SA
..2		ASSY-HOSE DRAIN(I)	MAH9700AWW,WINGS-PJT	1	I0023	SA
...3		CLIP-HOSE	SK-5,WLSL1100A,ID35 OD37.4,ZPC	1	N0020	SA
...3		HOSE-PUMP	SWF-P12,PP(BB110),ID21,OD26,-,	1	W0030	SA
..2		ASSY-CAP O.F	GW-PJT,SUDS	2	A0372	SA
...3		CAP-O.F	GW-PJT,PP,T2.8,-,-,GRY,OVER FL	1	A0047	SA
..2		ASSY-LEG	MAH9700AWW,GRY/BUTYL+BOLT	4	B0070	SA
...3		CASE-PRE WASH	WINGS-PJT,PP(TB53),-,-,-,W	1	J0028	SC
...3		DOOR-GLASS	TS85-PJT,BOROSILICATE,-,-,-,-	1	D0061	SC
...3		SCREW-TAPPING	TH,+,-,1,M4,L14,ZPC(YEL)	5	Z0015	SC
...3		ASSY-HOSE WATER	GW-PJT,HOT	1	I0040	SC
...3		ASSY-HOSE WATER	GW-PJT,COLD	1	I0040	SC
0.1		ASSY-CONTROL	WF316LAW,BETTER/WHT	1	C0027	
...3		PLATE-STEEL	MAH9700AWW,SBHG1-(GI),T0.4,W	1	Y0159	
..2		SPONGE-EPDM	SWF-P12,EPDM,-,T3,W15,L530,B	1	D0111	
..2		WOOD-STAY	SEW-PH100,NAWANG,-,T20,W570,L3	2		
..2		CUSHION-DOOR	MDE9700AYW,PS-FOAM,T8,W40,L	1	D0053	
..2		PACKING CASE-DESIGN	WF326AW,SW3,-,-,W748	1	A0015	
..2		CUSHION-TOP	WF326LAW,PS-FOAM,-,-,-,-,N	1	A0197	
...3		WASHER-PLAIN	SBC,ID8.4,OD30,T3,-,-,-	1	U0353	
...3		FIXER-TUB	GW-PJT,TB52,T8.0,WHT,OD25/L110	1	U0144	
...3		FIXER-WASHER	GW-PJT,NYLON,T2.0,NTR,FIXER	1		
...3		BOLT-HEX	M8,L155,ZPC(YEL),SWRCH18A,TAPP	1	U0320	
...3		FIXER-RUBBER	GW-PJT,EPDM,T5.0,NTR,-	1		
...3		COVER-TOP	GW-PJT,SECC(EGI),T1.0,W684,L56	1	P0053	
...3		SPONGE-HARNESS	KS-PJT,PU-FOAM,-,T3,W100,	1	W0059	
...3		BODY-DRAWER	GW-PJT,PP(TB-53),-,-,-,-,WHT	1	R0036	
...3		COVER-DRAWER	WF326LAW,ABS,-,-,-,-,WHT,	1		
...3		HANDLE-DRAWER	WF326LAW,ABS,-,-,-,-,WHT,F	1	R0155	
...3		PANEL-DRAWER	WF326LAW,ABS,-,-,-,-,WHT,LO	1	A0328	
...3		COVER-DETERGENT	GW-PJT,PP(TB-53),-,-,-,-	1	R0173	
...3		MASCOT	WF326LAW,NICKEL,T0.5,W10.5,L65	1	C0106	
...3		SPRING-DRAWER	FRONTIER,STS304,C/D 0.8,I/	1	R0122	
...3		FRAME-FRONT	WF326LAW,SECC,-,-,WHT,T0.8,W	1	F0103	
..2		ASSY-DOOR	WF316LAW,STS-DECO	1	D0001	
....4		COVER-DOOR	WF316LAW,ABS,T2.8,-,-,-,-,CR-	1	D0106	
....4		DECORATION-DOOR	WF326LAW,STS430,T0.6,-,-	1		
....4		TAPE-DOUBLE FACE	4930,EPDM,T0.6,W41,R213	10		
...3		SCREW-TAPPING	TH,+,-,1,M4,L12,ZPC(YEL),S	8	Z0006	
...3		SUPPORT-HINGE	FRONTIER-PJT,STS430,T1.2,-	1	D0105	
...3		ASSY-HINGE DOOR	FRONTIER-PJT,SINGLE	1		
..2		ASSY-PANEL CONTROL	WF316LAW,LOWES	1	C0002	
....4		KNOB-ENCODER(I)	K4-PJT,ABS,-,-,-,-,WHT,-	1	C0075	
....4		KNOB-ENCODER	WF326LAW,ABS,-,-,-,-,WHT,-	1	C0104	

## 8. ELECTRICAL PARTS LIST

Level	CODE NO.	DESCRIPTION	SPECIFICATION	QTY	SVC-Code	SA
.....5		DIODE-SWITCHING	1N4148,75V,150mA,DO-35,T	8		
.....5		LED	ROUND,Y-GRN,3mm,569nm	25	Y0063	
.....5		LED	ROUND,RED,3MM,630NM,-	1	Y0063	
.....5		IC-DARLINGTON DRIVER	KID65783AP,DIP,18P,	1	Y0051	
.....5		R-METAL OXIDE(S)	300ohm,5%,1W,AA,TP,3.3x	11		
.....5		C-CERAMIC,MLC-AXIAL	100nF,80-20%,50V,Y5V	1		
.....5		SWITCH-TACT	15V,20mA,130±40gf,6x6x5mm,S	11	Y0087	
.....5		HEADER-BOARD TO CABLE	BOX,12P,1R,2.5mm,S	1		
.....5		HEADER-BOARD TO CABLE	BOX,13P,1R,2.5mm,S	1		
.....5		LED DISPLAY	CSV-KSW07EG,FRONTIER-PJT,-,7	1	C0011	
.....5		SWITCH PRESSURE	V7 PJT,DC28V,10mA,24,-,J	1		
.....5		GUIDE-PCB(S)	WINGS-DRYER,HIPS,-,-,-,NTR,	1		
.....5		GUIDE-LED(B)	WF-G106AW,HIPS,-,-,-,NTR,FR	1		
.....5		GUIDE-LED(C)	WF-G106AW,HIPS,-,-,-,NTR,FR	1		
.....5		CHEMICALS-FLUX SOLDER	KS-77S,-,-,-,-,KOK	2		
.....5		CHEMICALS-ALCOHOL	ALL,MODEL,-,-,-,-,-	1		
.....5		SOLDER-WIRE	S63S,D3.0,-,-,-,-,-	10		
.....5		SOLDER-WIRE FLUX	RS60S,-,D1.2,60SN/40PB,	1		
.....5		IC-DRIVE	KID65003AP,DIP,16P,STICK,TR-AR	2	Y0052	
.....5		WIRE-SO COPPER	,PI0.6,SN,T,52MM TAPING W	53		
.....4		GUIDE-ENCODER	WF316LAW,ABS,-,-,-,CR-COAT	1		
.....4		PANEL-CONTROL	WF316LAW,ABS,-,-,-,WHT,I	1	C0082	
.....4		BUTTON-PUSH(F)	WF326LAW,ABS,-,-,WHT,FRON	1	C0043	
.....4		WINDOW-ENCODER	WF326LAW,SAN,-,-,-,TRAN	1	C0008	
.....4		BUTTON-PUSH(AG)	WF326AW,ABS,-,-,TRANSPAR	1		
.....4		INLAY-PANEL	WF316LAW,PET,T0.188,-,-,WHT,	1	A0242	
.....4		BUTTON-PUSH(C)	WF326LAW,ABS,-,-,TRANS,FR	1		
.....5		DIODE-SWITCHING	1N4148,75V,150mA,DO-35,T	8		
.....5		LED	ROUND,Y-GRN,3mm,569nm	35	Y0063	
.....5		LED	ROUND,RED,3MM,630NM,-	1	Y0063	
.....5		IC-DARLINGTON DRIVER	KID65783AP,DIP,18P,	1	Y0051	
.....5		R-METAL OXIDE(S)	300ohm,5%,1W,AA,TP,3.3x	12		
.....5		C-CERAMIC,MLC-AXIAL	100nF,80-20%,50V,Y5V	1		
.....5		SWITCH-TACT	15V,20mA,130±40gf,6x6x5mm,S	12	Y0087	
.....5		LED DISPLAY	CSV-KSW05EG,FRONTIER-PJT,-,7	1	C0011	
.....5		SWITCH PRESSURE	V7 PJT,DC28V,10mA,24,-,J	1		
.....5		GUIDE-LED(B)	WF-G106AW,HIPS,-,-,-,NTR,FR	1		
.....5		GUIDE-LED(C)	WF-G106AW,HIPS,-,-,-,NTR,FR	1		
.....5		ASSY-JUMP WIRE	WINGS-PJT,13P/130MM/WHT,-	2		
.....5		CHEMICALS-FLUX SOLDER	KS-77S,-,-,-,-,KOK	2		
.....5		CHEMICALS-ALCOHOL	ALL,MODEL,-,-,-,-,-	1		
.....5		SOLDER-WIRE	S63S,D3.0,-,-,-,-,-	10		
.....5		SOLDER-WIRE FLUX	RS60S,-,D1.2,60SN/40PB,	1		
.....5		IC-DRIVE	KID65003AP,DIP,16P,STICK,TR-AR	2	Y0052	
.....5		WIRE-SO COPPER	,PI0.6,SN,T,52MM TAPING W	51		
.....5		RESIN-PUR	CPU-55B/UEP 700FB,-,-,94V0	160.7		
.....5		RESIN-PUR	UEP 700FA/CPU-55A,-,-,94V0	80.3		
.....5		ADHESIVE-A.C.F	IR-100 BOND-EPOXY	1		
.....5		OIL-SILICON	G746,-,-	1		
.....5		DIODE-SWITCHING	RLS4148,75V,150mA,LL-34,	8		
.....5		DIODE-RECTIFIER	UF4007,1KV,1A,DO-41,TP	3		
.....5		DIODE-RECTIFIER	1N4007,1KV,1A,DO-41,TP	1		
.....5		DIODE-RECTIFIER	1N4937,600V,1A,DO-41,TP	3		
.....5		DIODE-RECTIFIER	SHG2D,200V,2A,-,TP	1		
.....5		DIODE-BRIDGE	GBJ1506,600V,15A,SIP-4,ST	1	E0001	
.....5		RESIN-PUR	CPU-55B/UEP 700FB,-,-,94V0	160.7		
.....5		RESIN-PUR	UEP 700FA/CPU-55A,-,-,94V0	80.3		
.....5		ADHESIVE-A.C.F	IR-100 BOND-EPOXY	1		
.....5		OIL-SILICON	G746,-,-	1		
.....5		DIODE-SWITCHING	RLS4148,75V,150mA,LL-34,	8		
.....5		DIODE-RECTIFIER	UF4007,1KV,1A,DO-41,TP	3		
.....5		DIODE-RECTIFIER	1N4007,1KV,1A,DO-41,TP	1		



## 8. ELECTRICAL PARTS LIST

Level	CODE NO.	DESCRIPTION	SPECIFICATION	QTY	SVC-Code	SA
....5		DIODE-RECTIFIER	1N4937,600V,1A,DO-41,TP	3		
....5		DIODE-RECTIFIER	SHG2D,200V,2A,-,TP	1		
....5		DIODE-BRIDGE	GBJ1506,600V,15A,SIP-4,ST	1	E0001	
....5		DIODE-ZENER	1N4749A,5%,1000mW,DO-41,TP	1		
....5		TR-SMALL SIGNAL	KSA928A-Y,PNP,1000mW,TO-	2		
....5		TR-DIGITAL	KRC246S,NPN,200mW,2.2K/10K,SO	2	E0002	
....5		PHOTO-COUPLER	TR,20-300%,200mW,DIP-4,ST	3		
....5		IC-CMOS LOGIC	4069,INVERTER,SOP,14P,150M	1	Y0050	
....5		IC-EEPROM	24C04,512x8,SOP,8P,5x4mm,2.5/5	1	Y0053	
....5		IC-VOLTAGE COMP.	7533,TO-92,3P,-,SINGLE,	1		
....5		THERMISTOR-PTC	27ohm,20%,-,265V,1.5A,360	1	Y0088	
....5		R-CARBON	10OHM,5%,1/4W,AA,TP,2.4X6.4MM	3		
....5		R-CARBON	27KOHM,5%,1/4W,AA,TP,2.4X6.4MM	1		
....5		R-CARBON(S)	47ohm,5%,1/2W,AA,TP,2.4x6.4m	2		
....5		R-COMPOSITION	1.5MOHM,5%,1/4W,AA,TP,2.5X	3		
....5		R-METAL OXIDE(S)	100Kohm,5%,2W,AA,TP,4x1	1		
....5		R-METAL OXIDE(S)	51Kohm,5%,2W,AA,TP,4x12	6		
....5		R-METAL OXIDE	240KOHM,5%,1W,AC,TP,3.3X9.	2		
....5		DIODE-RECTIFIER	1N4937,600V,1A,DO-41,TP	3		
....5		DIODE-RECTIFIER	SHG2D,200V,2A,-,TP	1		
....5		DIODE-BRIDGE	GBJ1506,600V,15A,SIP-4,ST	1	E0001	
....5		DIODE-ZENER	1N4749A,5%,1000mW,DO-41,TP	1		
....5		TR-SMALL SIGNAL	KSA928A-Y,PNP,1000mW,TO-	2		
....5		TR-DIGITAL	KRC246S,NPN,200mW,2.2K/10K,SO	2	E0002	
....5		PHOTO-COUPLER	TR,20-300%,200mW,DIP-4,ST	3		
....5		IC-CMOS LOGIC	4069,INVERTER,SOP,14P,150M	1	Y0050	
....5		IC-EEPROM	24C04,512x8,SOP,8P,5x4mm,2.5/5	1	Y0053	
....5		IC-VOLTAGE COMP.	7533,TO-92,3P,-,SINGLE,	1		
....5		THERMISTOR-PTC	27ohm,20%,-,265V,1.5A,360	1	Y0088	
....5		R-CARBON	10OHM,5%,1/4W,AA,TP,2.4X6.4MM	3		
....5		R-CARBON	27KOHM,5%,1/4W,AA,TP,2.4X6.4MM	1		
....5		R-CARBON(S)	47ohm,5%,1/2W,AA,TP,2.4x6.4m	2		
....5		R-COMPOSITION	1.5MOHM,5%,1/4W,AA,TP,2.5X	3		
....5		R-METAL OXIDE(S)	100Kohm,5%,2W,AA,TP,4x1	1		
....5		R-METAL OXIDE(S)	51Kohm,5%,2W,AA,TP,4x12	6		
....5		R-METAL OXIDE	240KOHM,5%,1W,AC,TP,3.3X9.	2		
....5		R-METAL	10Kohm,1%,1/8W,AA,TP,1.8x3.2mm	1		
....5		R-CHIP	100ohm,5%,1/4W,TP,3216	10		
....5		R-CHIP	10Kohm,5%,1/8W,TP,2012	11		
....5		R-CHIP	1Kohm,5%,1/8W,TP,2012	11		
....5		R-CHIP	1Mohm,5%,1/8W,TP,2012	2		
....5		R-CHIP	2.2Kohm,5%,1/4W,TP,3216	2		
....5		R-CHIP	20Kohm,5%,1/8W,TP,2012	2		
....5		R-CHIP	220ohm,5%,1/4W,TP,3216	9		
....5		R-CHIP	2Kohm,5%,1/8W,TP,2012	1		
....5		R-CHIP	4.7Kohm,5%,1/8W,TP,2012	10		
....5		R-CHIP	470ohm,5%,1/8W,TP,2012	1		
....5		R-METAL PLATE	0.03OHM,5%,5W,CL,BK,26X5X1	1		
....5		C-CERAMIC,DISC	2.2NF,10%,1KV,Y5P,BK,10X4	1		
....5		C-CERAMIC,MLC-AXIAL	10nF,+80-20%,25V,Y5V	3		
....5		C-CER,CHIP	100nF,10%,50V,X7R,2012	22		
....5		C-CER,CHIP	0.1nF,5%,50V,C0G,2012	1		
....5		C-CER,CHIP	10nF,10%,50V,X7R,2012	7		
....5		C-CER,CHIP	1nF,10%,50V,X7R,2012	4		
....5		C-CER,CHIP	4.7nF,10%,50V,X7R,TP,2012	3		
....5		C-FILM,LEAD-PEF	100nF,5%,630V,TP,27.5x12	1		
....5		C-AL	1uF,20%,50V,GP,TP,4x7,5	1		
....5		C-AL	47uF,20%,50V,GP,TP,6.3x11,2.5	1		
....5		C-AL	1000uF,20%,25V,GP,TP,10x20,5mm	2		
....5		C-AL	47uF,20%,50V,WT,TP,6.3x11,5	4		
....5		C-AL	470uF,20%,16V,GP,TP,8x11.5,5	1		
....5		C-AL	820UF,20%,250V,GP,BK,30X40MM,1	2		

## 8. ELECTRICAL PARTS LIST

Level	CODE NO.	DESCRIPTION	SPECIFICATION	QTY	SVC-Code	SA
....5		RESONATOR-CERAMIC	16MHZ,±0.5%,TP,5.5X6.	1	Y0115	
....5		BUZZER-PIEZO	85DB,12V,-,2.0KHZ,ST	1		
....5		RELAY-MINIATURE	12Vdc,200mW,3000mA,1Form	8	Y0118	
....5		RELAY-POWER	12VDC,-,25000MA,1FORMA,20MS,	1	Y0116	
....5		RELAY-POWER	12VDC,-,25000mA,1FormA,20mS,	1	Y0116	
....5		FUSE	250V,8A,FAST-ACTING,-,5.6x21mm	1		
....5		HEADER-BOARD TO CABLE	BOX,2P,1R,8MM,STRA	1		
....5		HEADER-BOARD TO CABLE	BOX,8P,2R,4.2mm,ST	1		
....5		HEADER-BOARD TO CABLE	BOX,3P,1R,10MM,STR	2		
....5		CONNECTOR-HEADER	BOX,5P,1R,2.5mm,STRAIGH	1	Y0117	
....5		HEADER-BOARD TO CABLE	BOX,13P,1R,2.5mm,S	2		
....5		HEADER-BOARD TO CABLE	BOX,9P,1R,2.5mm,ST	1		
....5		HEADER-BOARD TO CABLE	BOX,4P,1R,2.5mm,ST	1		
....5		HEADER-BOARD TO CABLE	BOX,5P,1R,2.5mm,ST	1		
....5		SCREW-MACHINE	BH,+ ,M3,L10,ZPC(YEL),SWRCH	2		
....5		PLD-MICOM	TMP88PS43F/OTP,QFP,80PIN	1	C0010	
....5		IC HYBRID	BP5049-15,IC HYBRID,7 PIN,-25	1	Y0049	
....5		IC HYBRID-IPM	PS21963,-,25,-20~100,DIP,1	1		
....5		TRANS SWITCHING	EE2229,MES-5HR123A-00,K1	1	Y0090	
....5		PCB-MAIN	FRONTIER,FR-4,NL 1,-,T1.6,D 19	1		
....5		GUIDE-PCB	GW-PJT,ABS(V0),-,-,NTR,STAND	1	Y0002	
....5		HEAT SINK	MA8800AW,AL,T2,W30,L35,WHT,-,C	1	Y0044	
....5		HEAT SINK	FRONTIER,-,W40,L115,BLK,-,-,	1	Y0044	
....5		CHEMICALS-FLUX SOLDER	KS-77S,-,-,-,KOK	5		
....5		CHEMICALS-ALCOHOL	ALL,MODEL,-,-,-,-,-	1		
....5		SOLDER-WIRE	S63S,D3.0,-,-,-,-,-	20		
....5		SOLDER-WIRE FLUX	RS60S,-,D1.2,60SN/40PB,	1		
....5		IC-VOLT REGU	KA7805A,TO-220AB,1A,0/125C,	1	Y0057	
....5		IC-DRIVE	KID65003AP,DIP,16P,STICK,TR-AR	2	Y0052	
....5		WIRE-SO COPPER	PI0.6,SN,T,52MM TAPING W	7		
....5		C-AL	10uF,20%,35V,GP,TP,4x7mm,5	1		
..2		ASSY-CUSHION BOTTOM	WF316LAW,LOWES	1	X0049	
...3		CUSHION-BOTTOM	WF-G126,PS-FOAM,-,-,-,-	1	X0007	
...3		TAPE-OPP	-,-,-,W50,-,-,YEL/WHT,-,-	2		
0.1		ASSY-COVER DRUM	WF326LAW,FRONTIER	1	R0010	
..2		WIRE-VINYL	SEW-100JL,PVC,-,T2.0*L150,-	2		
...3		ASSY-GUIDE WATER	WF326LAW,FRONTIER	1	R0021	
...4		GUIDE-WATER(U)	WF326LAW,ABS,-,-,-,20X8	1	R0088	
...4		PLATE-SILVER	WF326LAW,SIL,T0.8,W80,H20,S	2	R0111	
...4		GUIDE-WATER(L)	WF-G126AW,ABS,-,-,-,20X	1	R0087	
...4		HOUSING-DRAWER(M)	GW-PJT,PP(TB-53),-,-,-	1	R0097	
...4		HOUSING-DRAWER(U)	GW-PJT,PP(TB-53),-,-,-	1	R0098	
..2		ASSY-GUIDE WIRE	WINGS-PJT,SPONGE/HOLDER	1		
...3		BRACKET-ABSORBER	GW27,SBHG1-A,T1.0,W170,	1	U0378	
...3		SPRING-ABSORBER	GW-PJT,SWC,CD2,ID16,OD20	8	U0379	
...3		WEIGHT-ABSORBER	GW-PJT,ZNDC,WEIGHT390G,-	1		
...3		WEIGHT-ABSORBER	GW-PJT,ZNDC,WEIGHT305G,-	1		
...3		RESIN-PUR	CPU-55B/UEP 700FB,-,-,94V0	20		
...3		RESIN-PUR	UEP 700FA/CPU-55A,-,-,94V0	30		
...3		DIODE-RECTIFIER	UF4007,1KV,1A,DO-41,TP	2		
...3		DIODE-RECTIFIER	1N4007,1KV,1A,DO-41,TP	4		
...3		DIODE-RECTIFIER	SHG2D,200V,2A,-,TP	1		
...3		DIODE-ZENER	1N4751,28.5-31.5(5%),1000MW,	2		
...3		TR-SMALL SIGNAL	KSA928A-Y,PNP,1000mW,TO-	4		
...3		PHOTO-COUPLER	TR,130-260%,200mW,DIP-4,ST	5		
...3		IC-POSI.FIXED REG.	7818,TO-220,3P,-,PLAS	1		
...3		IC-PWM CONTROLLER	266,DIP,8P,300MIL,PLAS	1	Y0055	
...3		THERMISTOR-PTC	27ohm,20%,-,265V,1.5A,360	1	Y0088	
...3		R-CARBON	20KOHM,5%,1/8W,AA,TP,1.8X3.2MM	1		
...3		R-CARBON	47OHM,5%,1/4W,AA,TP,2.4X6.4MM	1		
...3		R-CARBON(S)	100OHM,5%,1/2W,AA,TP,2.4X6.4	2		
...3		R-CARBON	220OHM,5%,1/4W,AA,TP,2.4X6.4MM	1		
...3		R-CARBON(S)	100KOHM,5%,1/2W,AA,TP,2.4X6.	1		



## 8. ELECTRICAL PARTS LIST

Level	CODE NO.	DESCRIPTION	SPECIFICATION	QTY	SVC-Code	SA
...3		R-CARBON	1KOHM,5%,1/8W,AA,TP,1.8X3.2MM	4		
...3		R-CARBON	4.7KOHM,5%,1/8W,AA,TP,1.8X3.2M	12		
...3		R-METAL OXIDE(S)	27ohm,5%,2W,AA,TP,4x12m	1		
...3		R-CEMENT	120ohm,5%,5W,CJ,TP,14x10x27mm	1		
...3		C-CERAMIC,DISC	10nF,+80-20%,250V,Y5V,-,1	1		
...3		C-CERAMIC,DISC	2.2NF,10%,1KV,Y5P,BK,10X4	1		
...3		C-CERAMIC,MLC-AXIAL	100nF,80-20%,50V,Y5V	2		
...3		C-AL	10uF,20%,35V,GP,TP,4x7mm,5	2		
...3		C-AL	1uF,20%,50V,GP,TP,4x7,5	1		
...3		R-CARBON	1KOHM,5%,1/8W,AA,TP,1.8X3.2MM	4		
...3		R-CARBON	4.7KOHM,5%,1/8W,AA,TP,1.8X3.2M	12		
...3		R-METAL OXIDE(S)	27ohm,5%,2W,AA,TP,4x12m	1		
...3		R-CEMENT	120ohm,5%,5W,CJ,TP,14x10x27mm	1		
...3		C-CERAMIC,DISC	10nF,+80-20%,250V,Y5V,-,1	1		
...3		C-CERAMIC,DISC	2.2NF,10%,1KV,Y5P,BK,10X4	1		
...3		C-CERAMIC,MLC-AXIAL	100nF,80-20%,50V,Y5V	2		
...3		C-AL	10uF,20%,35V,GP,TP,4x7mm,5	2		
...3		C-AL	1uF,20%,50V,GP,TP,4x7,5	1		
...3		R-CARBON	1KOHM,5%,1/8W,AA,TP,1.8X3.2MM	4		
...3		R-CARBON	4.7KOHM,5%,1/8W,AA,TP,1.8X3.2M	12		
...3		R-METAL OXIDE(S)	27ohm,5%,2W,AA,TP,4x12m	1		
...3		R-CEMENT	120ohm,5%,5W,CJ,TP,14x10x27mm	1		
...3		C-CERAMIC,DISC	10nF,+80-20%,250V,Y5V,-,1	1		
...3		C-CERAMIC,DISC	2.2NF,10%,1KV,Y5P,BK,10X4	1		
...3		C-CERAMIC,MLC-AXIAL	100nF,80-20%,50V,Y5V	2		
...3		C-AL	10uF,20%,35V,GP,TP,4x7mm,5	2		
...3		C-AL	1uF,20%,50V,GP,TP,4x7,5	1		
...3		C-AL	47uF,20%,50V,GP,TP,6.3x11,2,5	1		
...3		C-AL	470uF,20%,25V,GP,TP,10x16,5	1		
...3		C-AL	10uF,20%,450V,GP,TP,10X20mm,5	1		
...3		HEADER-BOARD TO CABLE	BOX,3P,1R,10MM,STR	1		
...3		HEADER-BOARD TO CABLE	BOX,9P,1R,2.5mm,ST	1		
...3		TRANS SWITCHING	EE1616-H,AG-KIT,-,80 ~ 1	1	Y0090	
...3		COIL-INDUCTOR	ADR3102J,1000uH,5%,radial,	1		
...3		PCB-MAIN	2ND AG-KIT/HI ACTIVE,FR-1,1,-,	1		
...3		GUIDE-PCB(S)	WF-G126AW,HIPS(V0),T2.8,-,-	1		
...3		SOLDER-WIRE	S63S,D3.0,-,-,-,-,-,-	1		
...3		SOLDER-WIRE FLUX	RS60S,-,D1.2,60SN/40PB,	1		
...3		IC-OP AMP	KA2904,DIP,-,-,-,-,-	1		
...3		IC-LINEAR	LM393/A,DIP,COMPARATOR,-,-,-,-,-	1	Y0054	
...3		WIRE-SO COPPER	,PI0.6,SN,T,52MM TAPING W	10		
...3		PIN-EYELET	-,BRASS,-,-,-,-,ID1.5 OD2.8	3		
...3		RESIN-PUR	CPU-55B/UEP 700FB,-,-,94V0	12		
...3		RESIN-PUR	UEP 700FA/CPU-55A,-,-,94V0	8		
...3		ADHESIVE-A.C.F	IR-100 BOND-EPOXY	1		
...3		R-CARBON	4.7KOHM,5%,1/8W,AA,TP,1.8X3.2M	1		
...3		R-CHIP	0ohm,5%,1/4W,TP,3216	1		
...3		R-CHIP	100ohm,5%,1/4W,TP,3216	1		
...3		R-CHIP	4.7Kohm,5%,1/8W,TP,2012	3		
...3		C-CER,CHIP	100nF,10%,50V,X7R,2012	3		
...3		C-CER,CHIP	10nF,10%,50V,X7R,2012	2		
...3		C-AL	10uF,20%,35V,GP,TP,4x7mm,5	2		
...3		HEADER-BOARD TO CABLE	BOX,5P,1R,2.5mm,ST	1		
...3		SENSOR-MEMS	LIS2L02AS4,MAH9600,-40 to 85	1		
...3		PCB-SUB	MFS-MEMS-00,FR-1,1.5,T1.6,-,-,	1		
...3		GUIDE-PCB(M)	WF326LAW,PP,T2.8,-,-,NTR,ME	1	Y0003	
...3		CHEMICALS-FLUX SOLDER	KS-77S,-,-,-,-,KOK	1		
...3		CHEMICALS-ALCOHOL	ALL,MODEL,-,-,-,-,-,-	1		
...3		SOLDER-WIRE	S63S,D3.0,-,-,-,-,-,-	5		
...3		SOLDER-WIRE FLUX	RS60S,-,D1.2,60SN/40PB,	1		
...3		IC-OP AMP	KA2904,DIP,-,-,-,-,-	1		
...3		WIRE-SO COPPER	,PI0.6,SN,T,52MM TAPING W	1		

## 8. ELECTRICAL PARTS LIST

Level	CODE NO.	DESCRIPTION	SPECIFICATION	QTY	SVC-Code	SA
..2		ASSY-TUB BACK	GW-PJT,WASH-ONLY	1	U0013	
...3		BOLT-ETC	M7.5,L30,ZPC3(WHT),SWRCH18A,HE	20	U0097	
...3		BEARING-BALL	6307ZZ,ID35,OD80,L21,STS304	1		
...3		BEARING-BALL	6306ZZ,ID30,OD72,L19,STS304	1		
...3		ASSY-SEMI TUB BACK	WINGS-PJT,SAMBAK	1	U0078	
....4		TUB-BACK	GW-PJT,FRPP(GF15%),PI 602,PI 6	1	U0024	
....5		RESIN-FRPP	SUPRAN 2315SDR,NTR,2315SDR,-	5,395.00		
....4		BRACKET-NUT	SBHG-R,P1291,T3,-,-,NO-PAI	2	U0023	
....4		LABEL-TUB	W/M,-,YUPO,-,W60,L20,-,WHT,-,-	1		
....4		ASSY-HOUSING BEARING	GW-PJT,6306/6307ZZ	1	U0017	
....5		BEARING-BALL	6207ZZ,ID35,OD72,L17,STS304	1		
....5		HOUSING-BEARING	GW-PJT,ALDC8,T5,W205,L11	1	U0021	
....5		BUSH-BEARING	GW-PJT,SMF-4030,SM15C,ID72,	1		
...3		WIRE-VINYL	SEW-100JL,PVC,-,T2.0*L150,-	1		
...3		DRUM-FRONT	GW-PJT,STS430 H/L NO4,-,ID561	1	R0002	
...3		DRUM-BACK	GW-PJT,STS430 H/L NO4,ID561,OD	1	R0005	
...3		DRUM-WRAPPER	GW-PJT,STS430 H/L NO4,T0.6,	1	R0003	
....4		FLANGE-SHAFT	GW-PJT,ALDC,T3.5,-,-,NTR,	1	R0009	
....4		ASSY-SHAFT	GW-PJT,DD-TYPE(3.3)	1	R0028	
....5		BUSH-SHAFT	TS85-PJT,ALDC,-,-,-,-	1	U0377	
....5		SHAFT	GW-PJT,SM45C,L219.9,OD 35,NTE,	1		
..2		ASSY-TUB FRONT	GW-PJT,3.3CuFt	1	U0026	
...3		CLAMPER HOSE	P1291,LYLON6/6,ID27,OD30,-,	1	N0012	
...3		ASSY-HOSE PRESSURE	WINGS-PJT,PU/TUB-FR	1	I0044	
....4		HOSE-PVC	MAH9700AWW,PVC,-,O26.4,T0.7,L6	1		
....4		SPONGE-CUSHION	SEW-3HR125,KIMOJI-PU-FOAM	2	A0365	
....4		TUB-FRONT	GW-PJT,FRPP(GF15%),ID602,OD608	1	U0030	
....5		RESIN-FRPP	SUPRAN 2315SDR,NTR,2315SDR,-	2,430.00		
....4		BRACKET-NUT	SBHG-R,P1291,T3,-,-,NO-PAI	6	U0023	
...3		WIRE-VINYL	SEW-100JL,PVC,-,T2.0*L150,-	4		
...3		CABLE CLAMP	DA-6N,ID10.0,T1.0,NYLON6/6,N	1	U0363	
....4		BOLT-HEX	M4,L60,ZPC3(WHT),SM10C,-	1	U0320	
....4		NUT-DIAPHRAGM	EGI,M4,-,-,2.5TX20X8	1	U0204	
....4		NUT-DIAPHRAGM	EGI,M4.2,-,-,2.5TX20X8	1	U0204	
....4		BRACKET-WIRE	ALL MODEL,SCP,T0.5,-,L58.4,	1		
....4		WIRE-DIAPHRAGM	WINGS-PJT,HSWR,-,OD2,L147	1	U0276	
0.1		ASSY-CASE	WF326LAW,FRONTIER	1	A0001	
..2		TAPE-OPP	W50,,YEL	0.8		
..2		CARD-REGISTRATION	USA,XAA,ENGLISH,MOJOJI	1	V0007	
..2		BAG PE	HDPE,T0.03,L400,W240,TRP,8,2,P	1		
..2		BAG SHEET	NITRON/HDPE,T0.5/T0.012,W1000,	1		
..2		BAND-PP	-,PP,T0.8,W17.5,-,WHT,-	14.2		
..2		LABEL-PACKING	W/M,-,ART,-,W90,L175,-,WHT	1		
..2		LABEL-WARNING	MAYTAG,-,ART+LAMI,-,W108,L	1	V0004	
..2		LABEL-WARNING	MAYTAG,-,ART+LAMI,-,W170,L	1	V0004	
..2		MANUAL-BOOK	WF326,SEA,ENGLISH,U.S,100MOJ	1	A0243	
..2		LABEL-ENERGY	WF326,SEA,ART,-,-,-,-,COV	1	V0005	
..2		LABEL RATING	WF326,SEA,YUPO,-,W25,L110,-	1	V0002	
..2		MANUAL-GUIDE	WF326,SEA,ENGLISH,U.S,100MO	1		
..2		LABEL-CAUTION	WF326,SEA,ART+LAMI,-,-,-,-	1	A0244	
..2		LABEL-POWER CORD	WF326,SEA,ART+LAMI,-,W1	1		
..2		LABEL-CLEARANCE	WF326,-,ART+LAMI,-,-,-,-	1		
..2		LABEL-WARNING	WF326,SEA,ART+LAMI,-,W230,	1	V0004	
..2		LABEL-HOSE	WF326,SEA,ART+LAMI,-,W285,L48	1		
..2		LABEL-BAR CODE	MOJO,W32,L125.5,-,-	1		
..2		TAPE-SCOTCH PAR	FILAMENT-TAPE,-,W50,-,-	1.2		
..2		ASSY-ACCESSORY	MAH9700AWW,WINGS-PJT	1		
...3		BAG PE	HDPE,T0.03,W350,L450,TRP,8,2	1		
...3		BAG PE	LDPE,T0.05,L230,W180,TRP,8,2,P	1		
0.1		ASSY-PAINT	WF316LAW,NEAT-WHT	1	F0062	
..2		CLAMPER HOSE	P1291,LYLON6/6,ID27,OD30,-,	1	N0012	
..2		CLAMPER HOSE	P1291,PP(BJ-730),ID24.5,OD2	1	N0001	
..2		GUIDE-SPRING	GW-PJT,POM,-,-,-,NTR,-	2	A0352	

## 8. ELECTRICAL PARTS LIST

Level	CODE NO.	DESCRIPTION	SPECIFICATION	QTY	SVC-Code	SA
..2		SPONGE-HARNESS	SEW-5G105A,PU-FOAM,-,T10,	4	W0059	
...3		SCREW-TAPPING	BH,+,,M4,L16,ZPC(BLK)	3	Z0062	
...3		PUMP-DRAIN	-,120V,60Hz,40mm,80W/3600RPM	1	J0025	
...3		CASE-PUMP	WINGS-PJT,PP(5113MF6),T3,W110,	1	J0019	
...3		SPONGE-EPDM	MAH9700,EPDM,-,T1.0,W15,L100	1	D0111	
...3		RIVET-RH	K1661-0512,AL(A5052),OD3.9,L11	4	F0117	
...3		FRAME	WINGS-PJT,PCM,-,-,WHT,T1.0,-,-	1	F0094	
....4		PLATE-STEEL	WINGS-PJT,SBHG1-A,T1.0,W961.	1	Y0159	
...3		BRACKET-SPRING(L)	WINGS-PJT,SBHG1-A,T1.6	1	F0079	
...3		BRACKET-SPRING(R)	WINGS-PJT,SBHG1-A,T1.6	1	U0364	
...3		ASSY-PLATE BOTTOM	GW-PJT,SBHG1-A/T1.6	1	F0066	
....4		PLATE-BOTTOM	GW-PJT,SBHG1-A,T1.6,W682,L6	1	X0014	
....4		BRACKET-LEG	WINGS-PJT,SWRCH6A,T2.0,-,-,Y	4	B0075	
...3		BUSH-HOSE(L)	WINGS-PJT,TPE(EPDM+PP),-,-,	1	I0024	
...3		SHUTTER-SUDS	GW-PJT,PP,T1.0,W63,L66,NTR,	1		
...3		PACKING-SUDS	GW-PJT,EPDM,PACKING,T6.0,W6	1		
...3		SPONGE-HARNESS	MAH9700AWW,PU-FOAM,-,T10,	1	W0059	
...3		NUT-HEXAGON FLANGE	1C,M10,ZPC(YEL),SCP-1	1	B0076	
...3		LEG-RUBBER	MAH9700AWW,BUTYL,-,GRY,-,WING	1	B0073	

---

**Memo**

---

# 9. BLOCK DIAGRAM

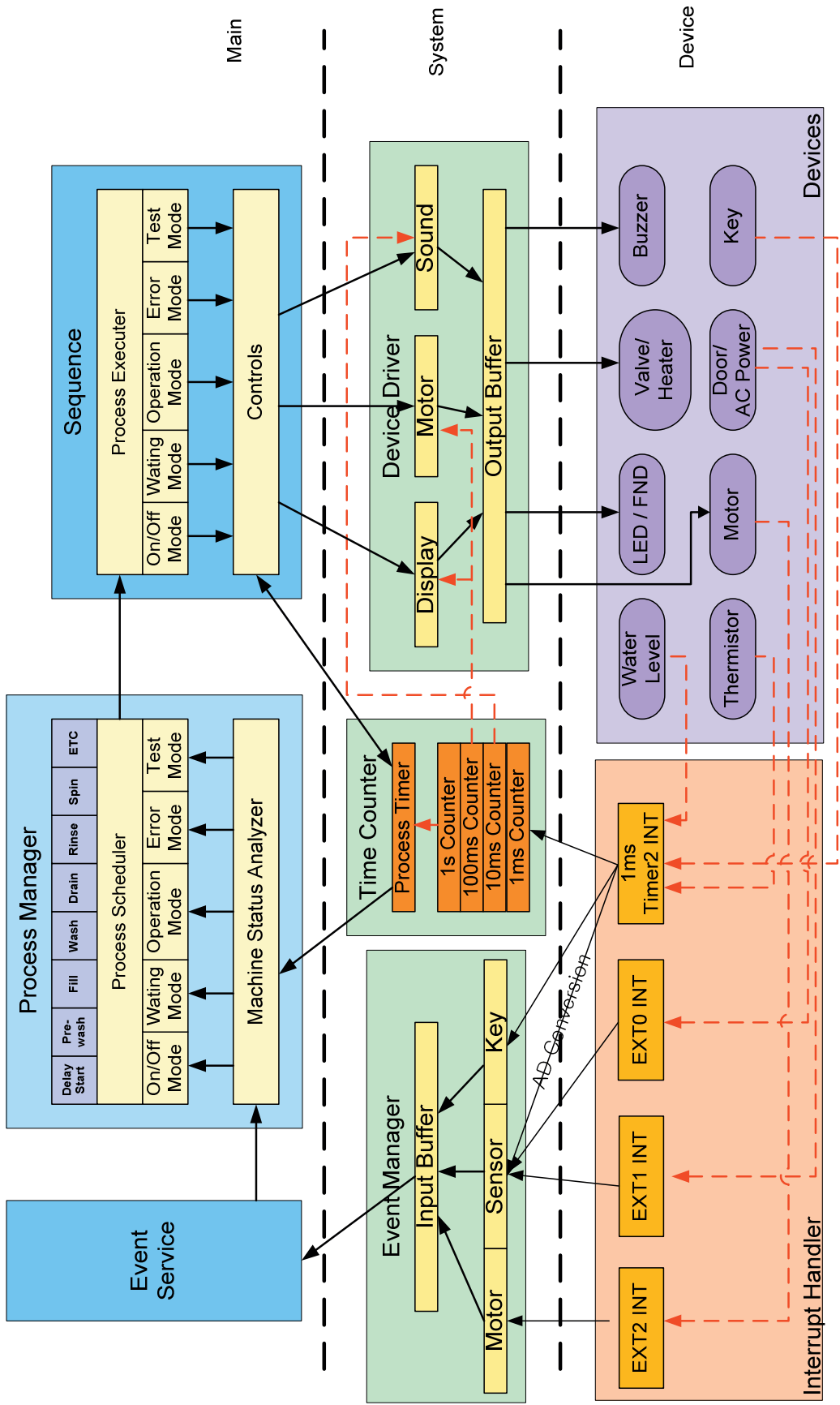

# Memo

# 10. WIRING DIAGRAM

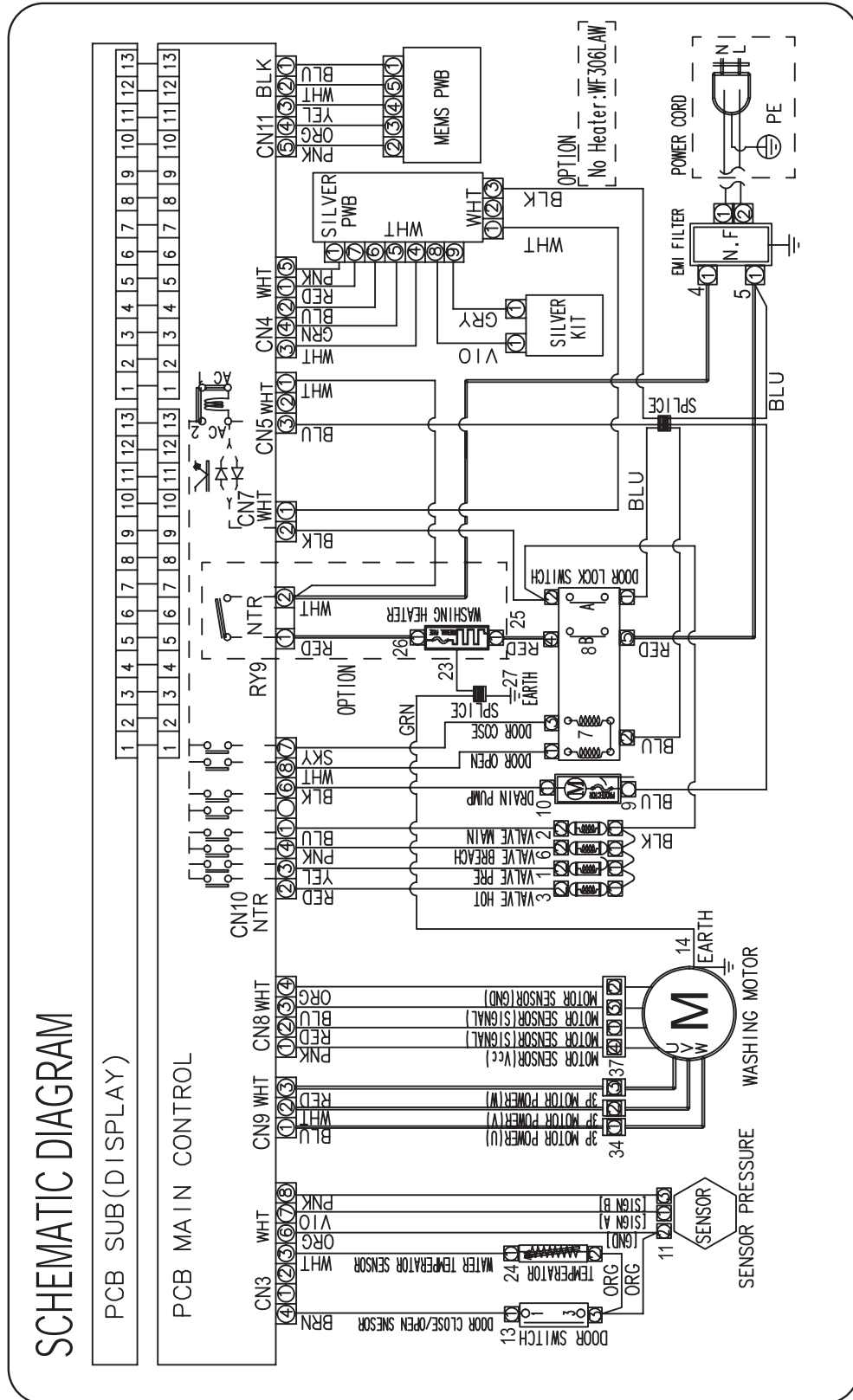

---

# Memo

---



# 11. PCB DIAGRAM

## 11-1 MAIN PCB LAYOUT

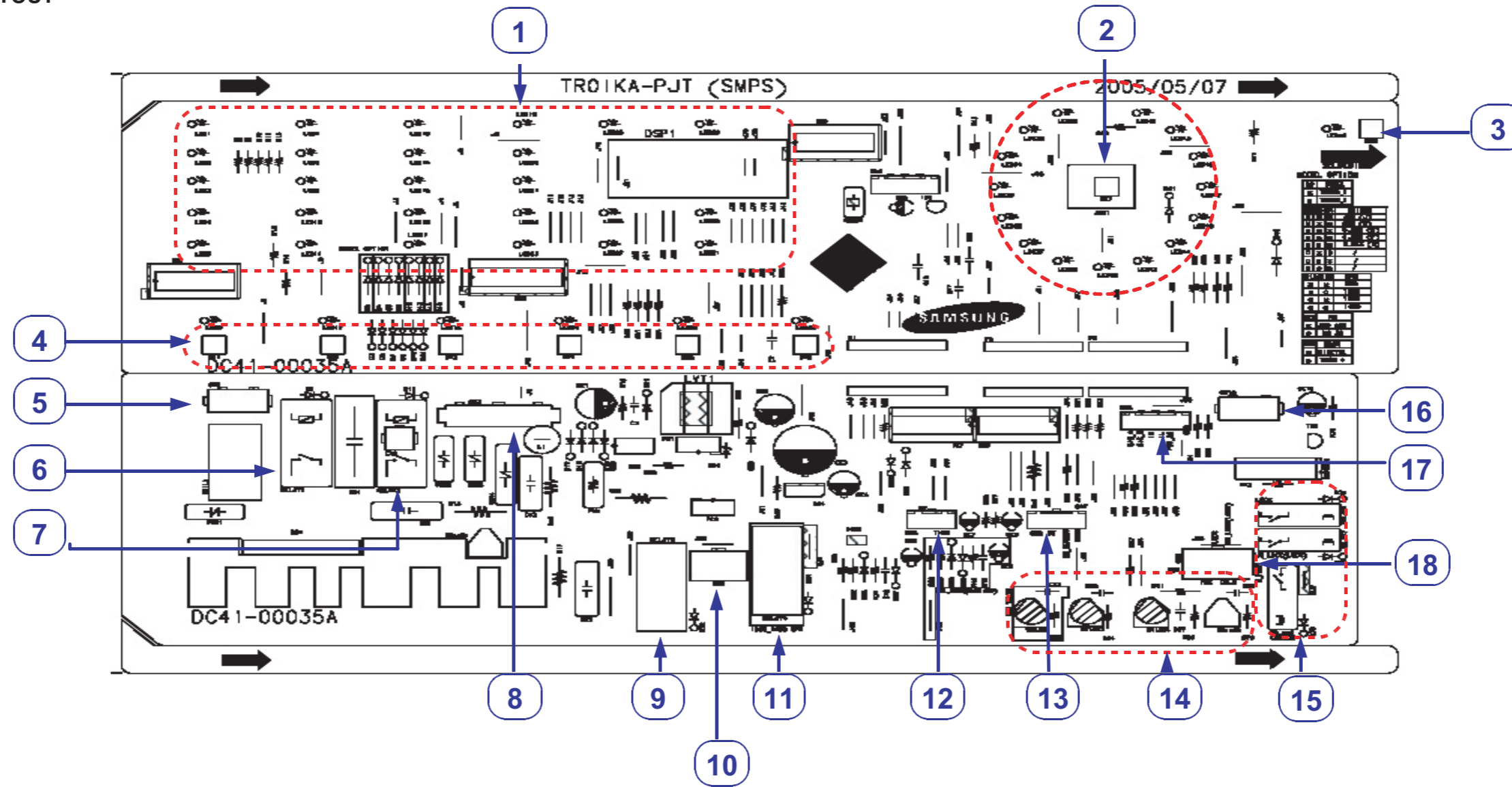

Item	Part Number	Description
1	Display	Displays or indicates operations or functions
2	Jog_Dial	Starts/stops an operation to select a course
3	Power_key	Turns the power on/off
4	Key	Selects and processes each function
5	CN1	Detects if the door is open or closed
6	RELAY1	In case of Power_On/Off, supplies or disconnects AC power
7	RELAY2	Disconnects Power from the Heater

Item	Part Number	Description
8	CN3	AC1과 GND를 연결함
9	RELAY3	Motor의 정/역 방향을 제어함
10	CN4	Motor의 동작 Wire를 연결함
11	RELAY4	고 RPM진행시 On/Off 제어함
12	CN6	Heat Sink의 온도Sensor를 연결함
13	CN7	수위,온도Sensor를 연결함
14	구동부	냉/온/Pre/Drain 동작용 부품

Item	Part Number	Description
15	Door System	Parts for Door Lock/Unlock
16	CN10	Connects Motor Tacho Sensor
17	CN8	Connects the silver nano wire
18	CN9	Connects the driving system wire

11-2 Connector & Relay Terminals Description (MAIN PCB)

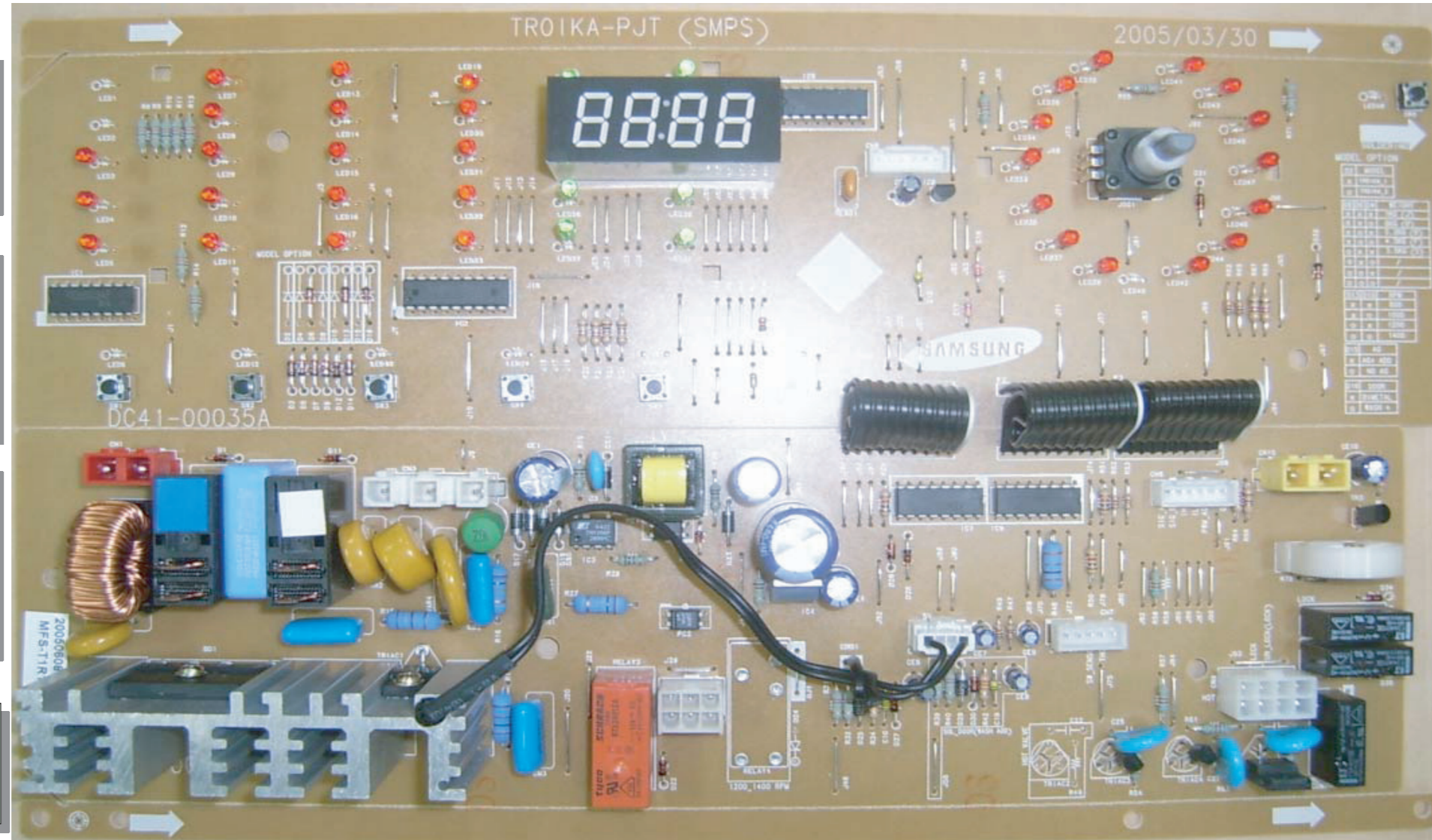

**RELAY1**

- A)Connects to AC2
- B)Connects to AC2-1
- COMMON

**RELAY2**

- A)Connects to the HEATER
- B)Connects to the HEATER

**CN1**

- A)Connects to the DOOR LOCK Signal
- B)Connects to the DOOR LOCK Signal

**CN3**

- ②Connects to AC1
- ③Connects to GROUND

**CN8**

- ①Connects to SIG-A
- ②Connects to SIG-B
- ③Connects to IH
- ⑤Connects to PWM
- ⑥Connects to GROUND

**CN10**

- A) Connects to the TACHO SENSOR
- B) Connects to the TACHO SENSOR

**CN4**

- ①Connects to the MOTOR STATOR
- ③Connects to the MOTOR STATOR
- ④Connects to the MOTOR STATOR
- ⑤Connects to the MOTOR STATOR
- ⑥Connects to the MOTOR STATOR

**CN6**

- ①Connects to the TEMP SENSOR
- ④Connects to the TEMP SENSOR

**CN7**

- ①Connects to GORUND
- ②Connects to 5V
- ③Connects to 5V
- ④Connects to the WATER SENSOR
- ⑤Connects to the TEMP SENSOR

**CN9**

- ①Connects to the DRAIN-MOTOR
- ②Connects to the COLD VALVE
- ③Connects to the PRE VALVE
- ④Connects to the HOT VALVE
- ⑥Connects to the ROLD DOOR S/W



**CN1**

- ①Connects to AC1
- ③Connects to AC2

**CN7**

- ①Connects to GORUND
- ②Connects to IH
- ③Connects to PWM
- ④Connects to SIGNAL-B
- ⑤Connects to SIGNAL-A
- ⑧Connects to AG-B
- ⑨Connects to AG-A



---

**Memo**

---

# 12. SCHEMATIC DIAGRAMS

## 12-1. Main PCB

\* This Document can not be used without Samsung's authorization.

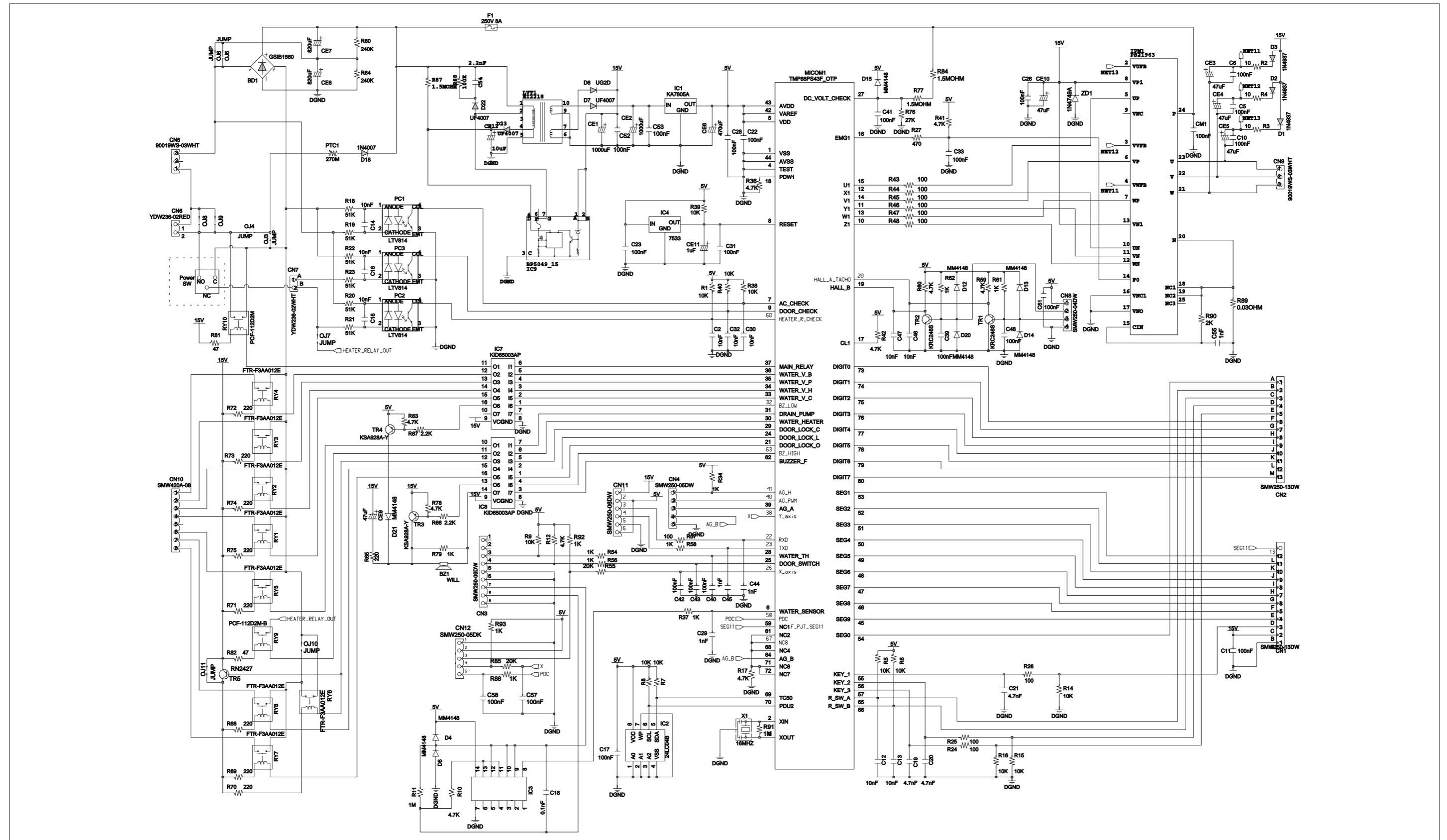

## 12-2. SUB PCB

\* This Document can not be used without Samsung's authorization.

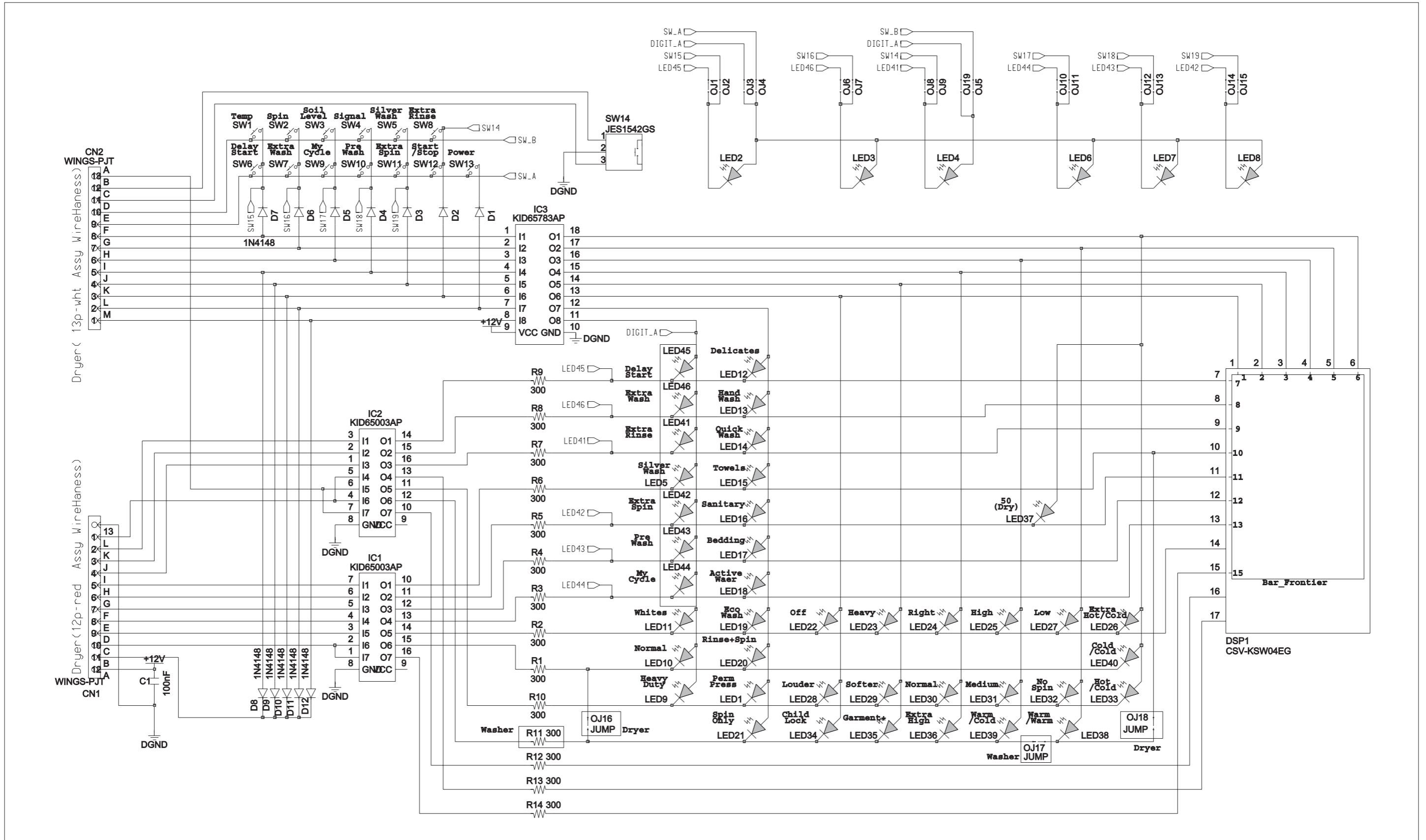

## 12-3. MEMS PCB

\* This Document can not be used without Samsung's authorization.

No.	PIN	FUNCTION
9	ST	Self Test (0:normal mode; 1:Self test)
11	PD	Power Down(0:normal mode; 1:Power-down mode)
13	FS	Full Scale (0:2g ; 1: 6g Full scale)

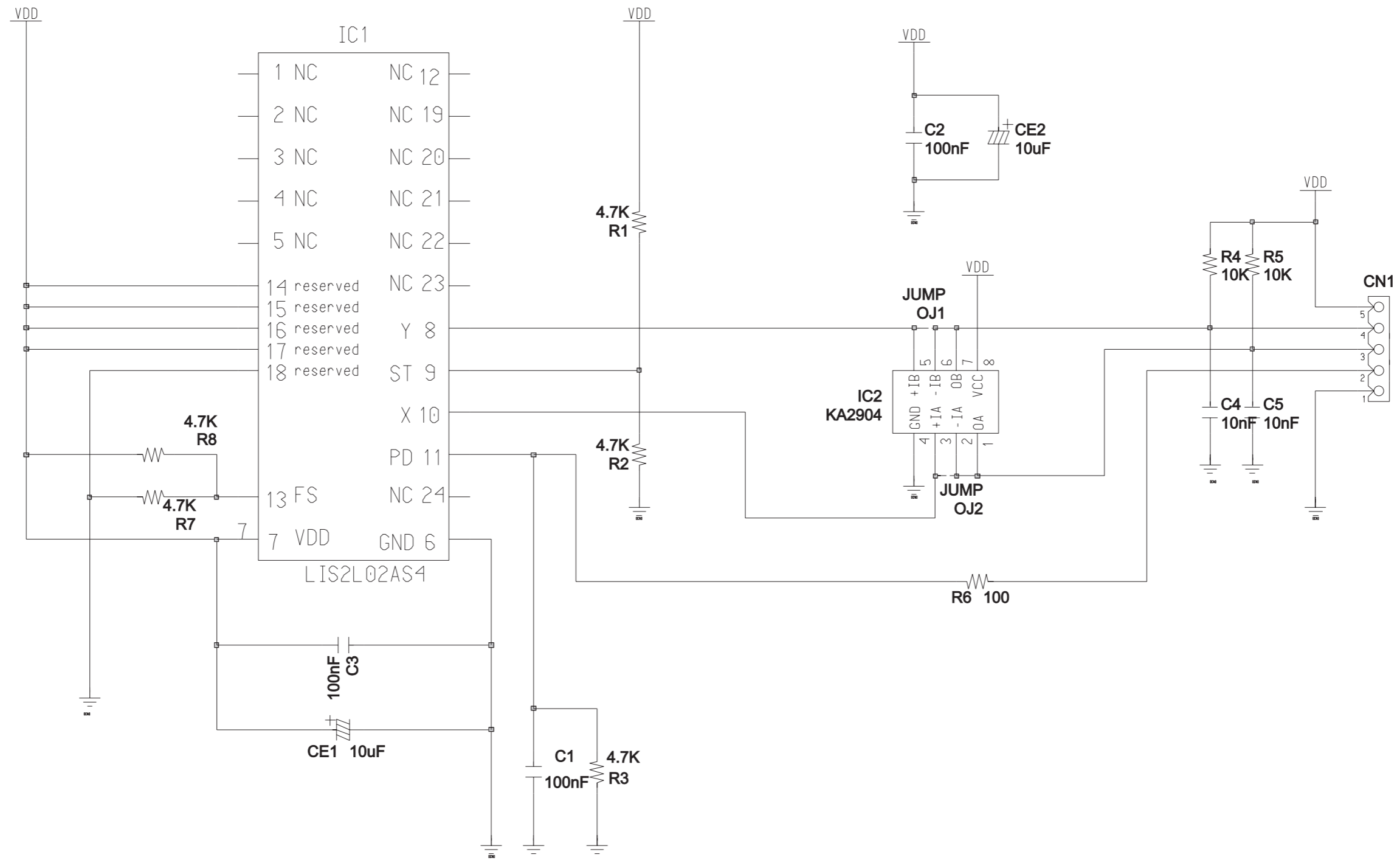

## 12-4. AG PCB

\* This Document can not be used without Samsung's authorization.

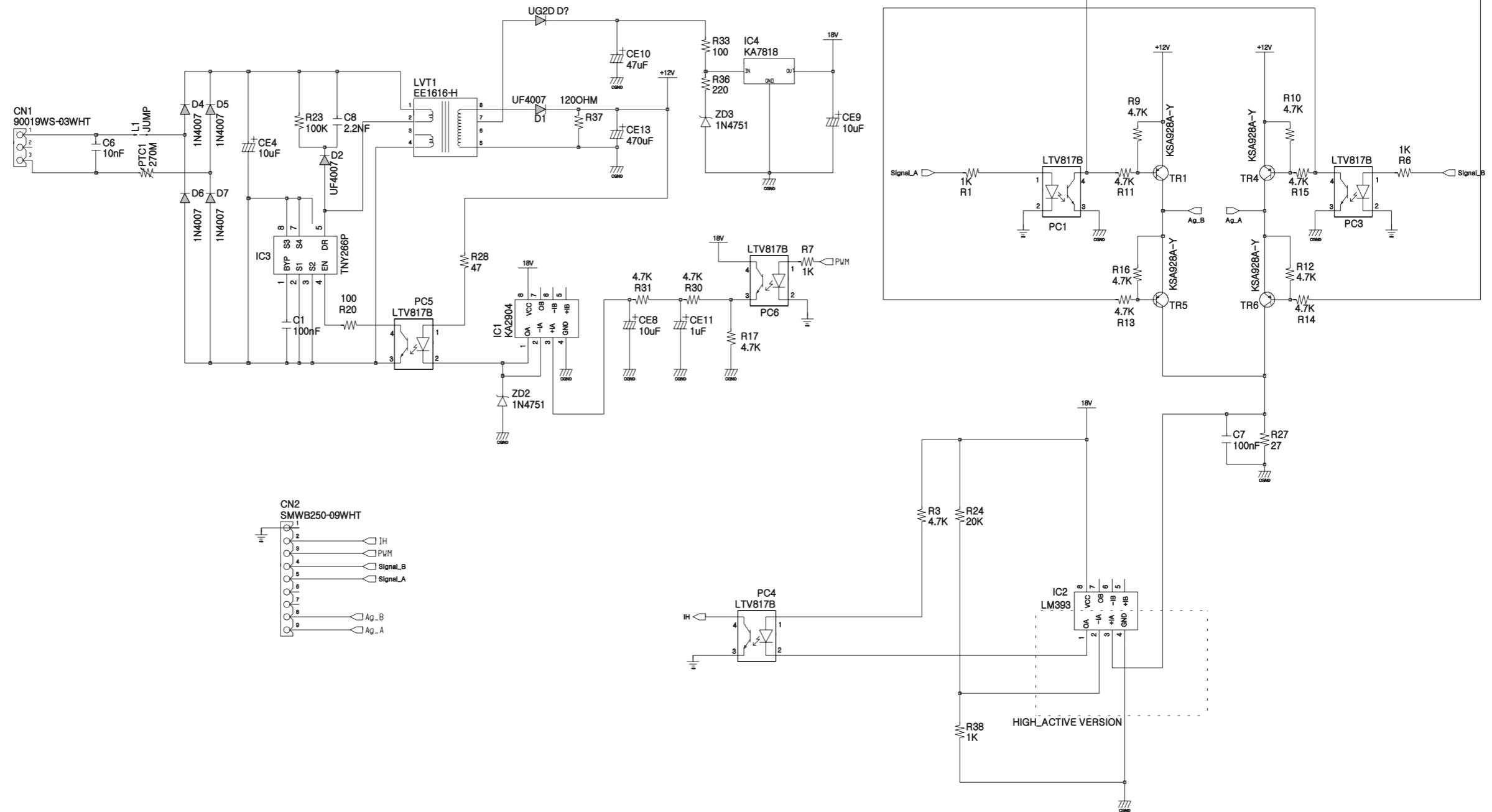

# 2ND AG\_KIT VERSION\_2



# 13. CIRCUIT DESCRIPTIONS

## 13-1. OVERALL SYSTEM

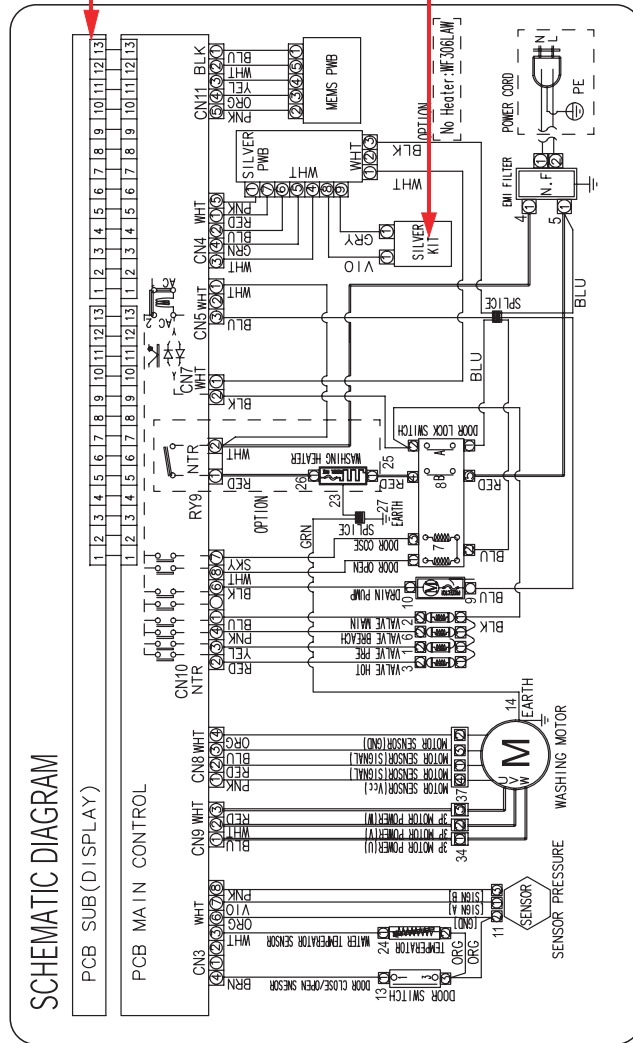
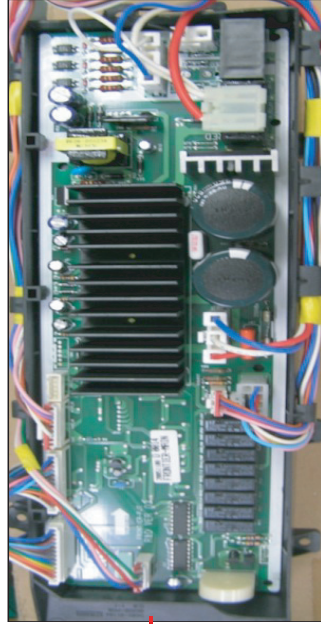

## 13-2. AC Input & Power Circuit

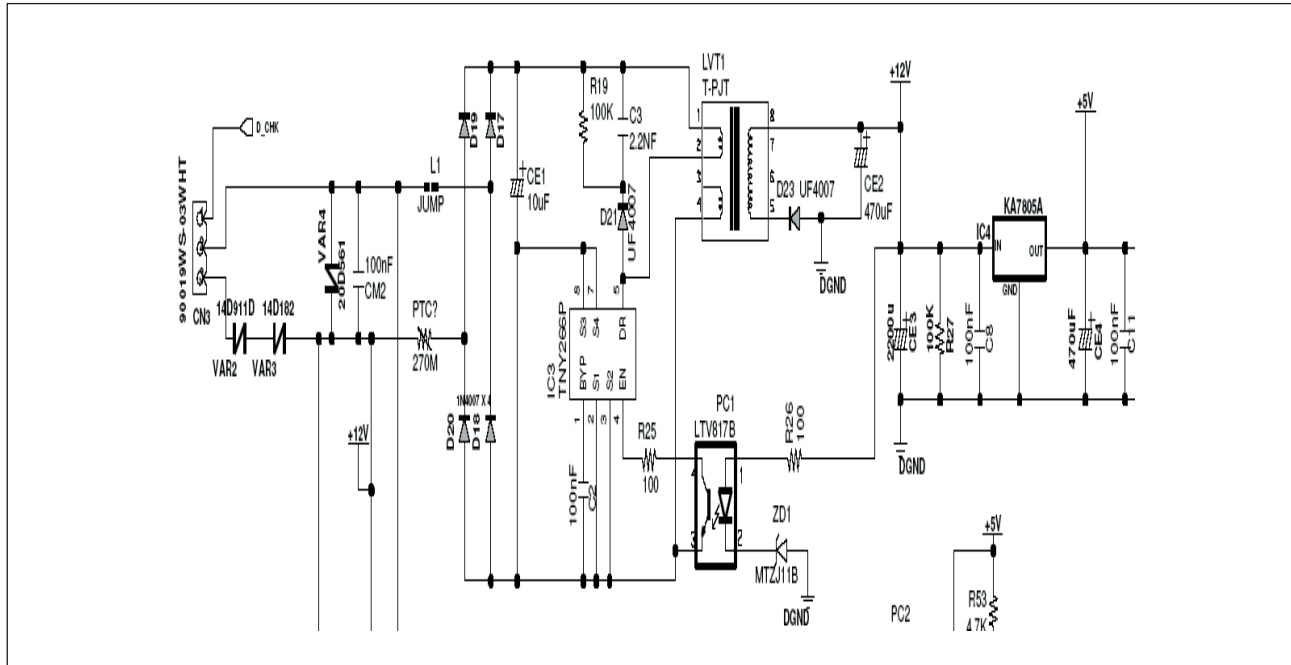

### ► Function

Generates a required DC power of 12V or 5V in case of supplied or disconnected AC power.

### ► Description

- When AC 220V is applied to CN3, D17 D20 transforms it to DC 300V.
- DC 300V is generated for the LVT1 secondary source by IC3 and PC1 turning on/off.
- The secondary 12V depends on the ZD1 value.
- The 12V for the LVT1 secondary source is transformed to DC 5V through IC4

### 13-3. Driving System Circuit

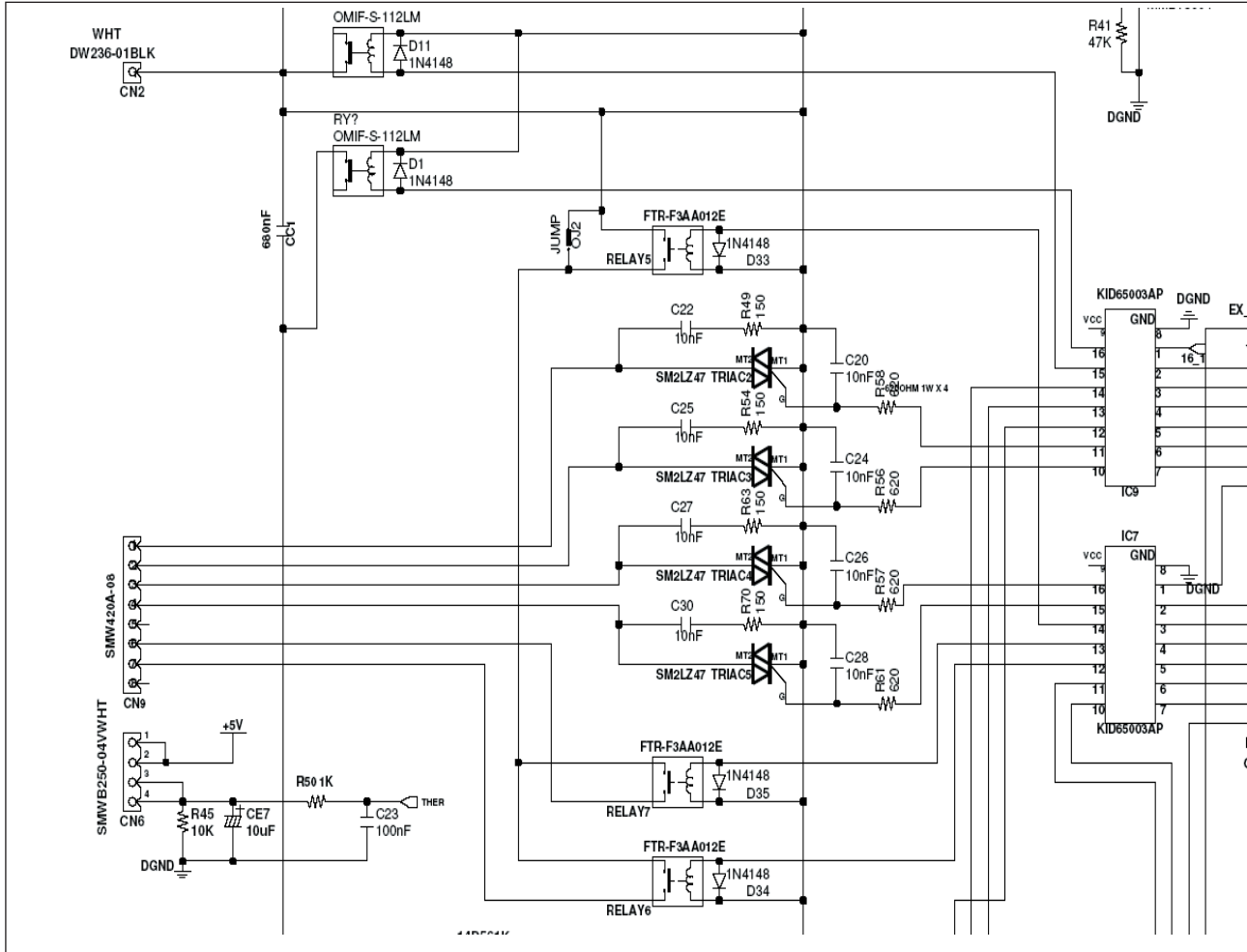

#### ► Function

Controls each driving system (VALVE, DOOR S/W, DRAIN-MOTOR) by turning RELAY or TRIAC on/off.

#### ► Description

- MICOM outputs a high signal of 5V from pin # 1 - 7 of IC7 and IC9.
- Then, pin # 10 to 16 of IC7 and IC9 are electrically grounded (0V).
- When pin # 10 to 16 are grounded, this creates an electric potential difference from the 12V that turns on RELAY 5,6,7 and TRIAC2,3,4,5.
- The operating parts (VALVE, DRAIN-MOTOR, DOOR S/W) connected to CN9 turn on if they are supplied with power.

## 13-4. Sensor Detection Circuit

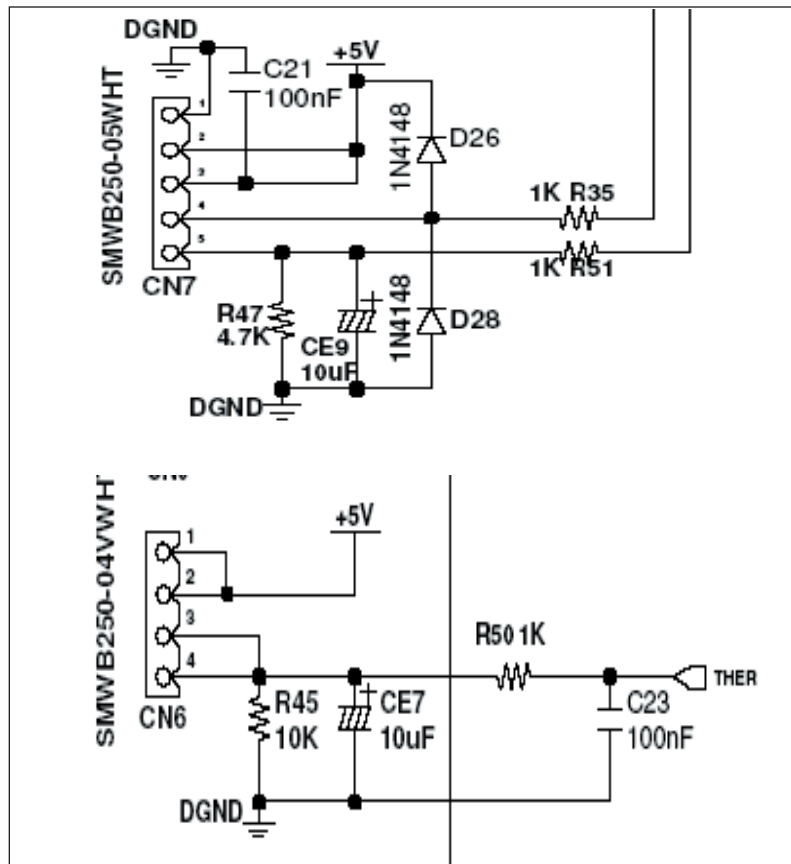

### ► Function

Detects signals from the sensor and controls the current system.

### ► Description

- The water level sensor is connected to pin 4 of CN7.
- The frequency of the level sensor changes according to the water amount in the tub.
- Then, the frequency is input to MICOM pin 48 for detecting the water amount.
- The DHSEH sensor is connected to CN7 pin 5 and CN6 pins 3,4.
- The resistance of the temp. sensor changes according to the ambient temperature. The changed resistance is applied to R50 and R51.
- The voltage applied to R50 and R51 is decided according the temp. MICOM stores the value.
- When voltage is applied to MICOM pins 22 and 23, MICOM compares it to the predefined one before detecting the current temp.

## 13-5. Silver Nano System

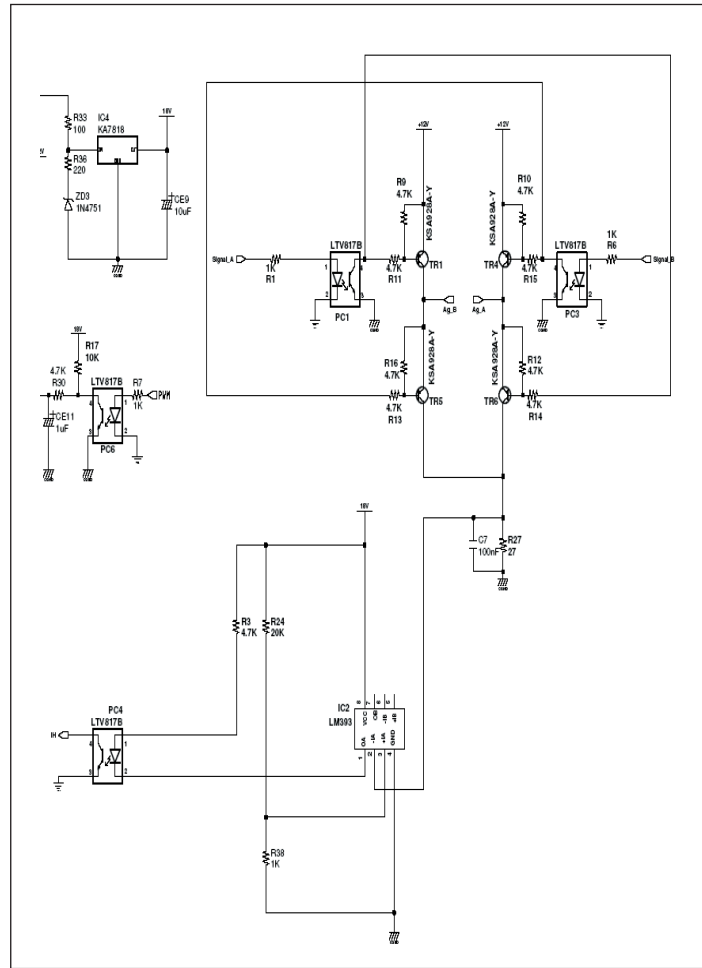

### ► Function

Applies the electric current to the silver plate during the water supply and uses the silver water to perform the bacteria-free or sterilization processes.

### ► Description

- Selects the silver nano feature to operate the system.
- Supplies water to the two silver plates AG\_B and AG\_A. Then, SIGNAL\_A and SIGNAL\_B output a high signal of 5V.
- Both SIGNAL\_A and SIGNAL\_B repeat this for 15 seconds outputting a high signal of 5V.
- SIGNAL\_A output turns TR1 and TR6 on to generate a potential difference between the 12V and the grounding for causing the current to flow. SIGNAL\_B output turns TR4 and TR5 on to generate a potential difference between the 12V and the grounding for causing the current to flow.
- The flowing current is transformed to a voltage by the resistance of R27.
- Then, the voltage is applied to IC1 pin 2 and used for detecting and controlling the flowing current.

---

**Memo**

---

# 14. REFERENCE INFORMATION

## 14-1. MODEL NAME

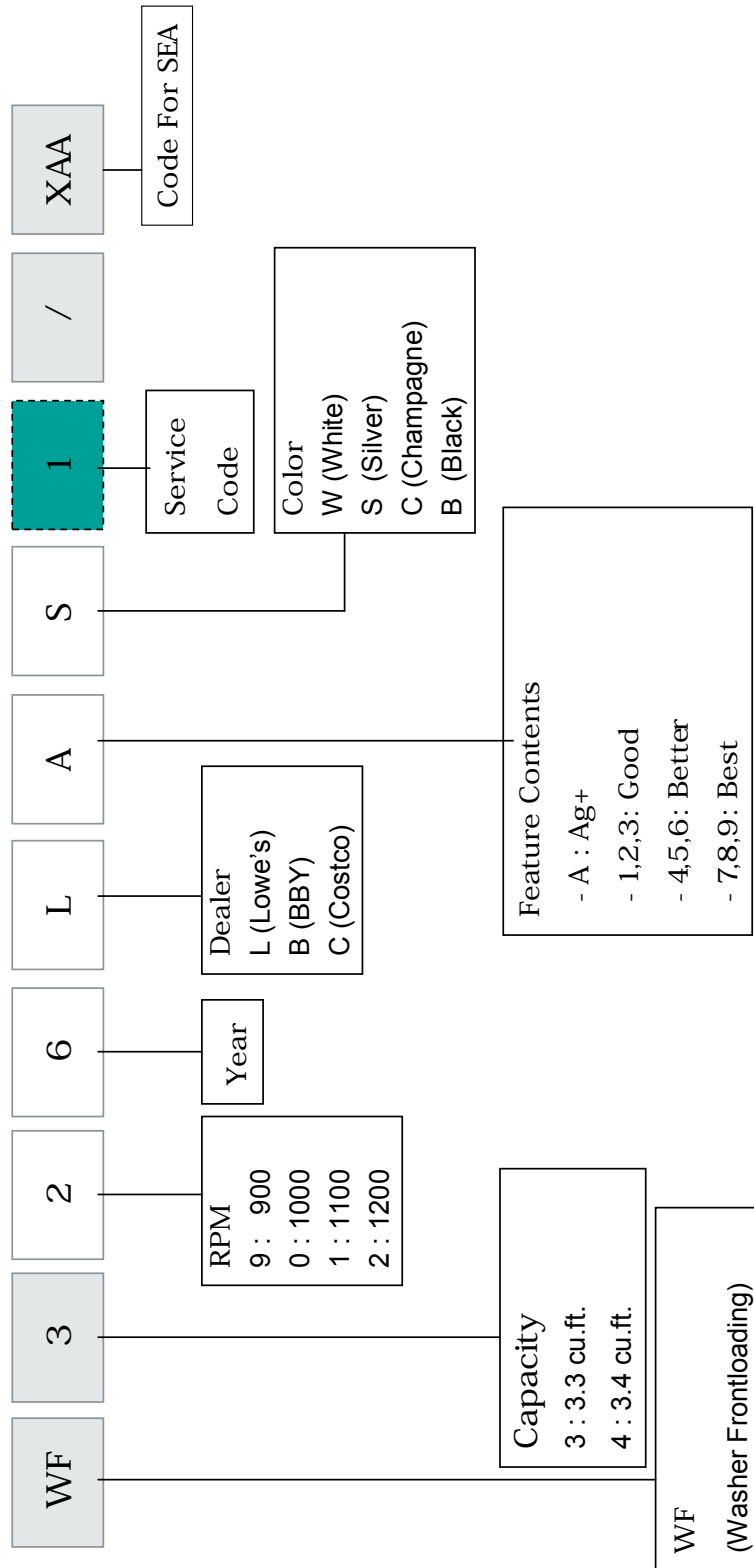

---

## 14-2. TERMINOLOGY

---

- 1) ASSY-MAIN PCB (Imbalance Sensor)
  - To prevent the laundry from gathering on one side of the tube causing noise and vibration, the washing machine uses an imbalance detection device that evenly disentangles the laundry before the hydrating cycle starts.
  
- 2) DOOR-LOCK S/W
  - Prevents the door from being opened while a cycle is in progress. For safety purposes, it keeps the door locked even in pause mode or after the washing cycle unless the water level frequency is greater than 24.8Khz (anti-overflow level) or the inside-tube temperature is less than 65°C in the hydrating cycle, and 55°C in the washing cycle.
  
- 3) SENSOR-PRESSURE (Anti Over-Flow)
  - When the water supplied is more than 2/3 of the tube capacity due to a malfunction of the water supply valve, this device automatically starts water-draining and displays “OVER-FLOW ERROR(E3)” on the LED.
  
- 4) THERMISTOR
  - Keeps sensing and controlling the temperature inside the tube to keep it below your settings.
  
- 5) ASSY-THERMAL FUSE (Anti Over-Heat)
  - When the washing heater is overheated due to an error in the thermistor or any other malfunction, the assy-thermal fuse (built in the heater) is automatically activated to disconnect the power for your and the product’s safety.
  
- 6) ASSY-MAIN PCB (Sensitive Laundry Protection)
  - To avoid any damage to sensitive laundry, the tube temperature is detected and “ERROR(E8)” is displayed on the LED for Wool or Lingerie courses when the temperature is over 50°C.
  
- 7) THERMOSTAT (Anti Over-Heat)
  - When the heater (drier) overheats from an error in the thermistor or any other malfunction, the thermostat (installed on the drying duct) is automatically activated to disconnect the power for your or product’s safety
  
- 8) CHILD LOCK
  - Prevents children from playing with the washing machine.
  
- 9) **PRE-WASH**
  - The machine does a preliminary wash of about 10 minutes prior to the main wash. This is particularly effective for cleaning badly stained laundry.





































## 14-3. FABRIC CARE CHART

The following symbols provide garment care directions without words.

The care label will include, in order, four symbols: washing, bleaching, drying and ironing, or dry cleaning when necessary.

The use of symbols ensures consistency among garment manufacturers of domestic and imported items. Follow care label directions to maximize garment life and reduce laundering problems.

Wash Cycle		Special Instructions		Warning symbols for laundering	
	Normal		Line Dry/ Hang to Dry		Do Not Wash
	Permanent Press/Wrinkle Resistant/ Wrinkle Control		Drip Dry		Do Not Wring
	Gentle/Delicates		Dry Flat		Do Not Bleach
	Hand Wash	Heat Setting			Do Not Tumble Dry
Water Temperature**			High		No Steam (added to iron)
	Hot		Medium		Do Not Iron
	Warm		Low		
	Cold		Any Heat		
Bleach			No Heat/Air		
	Any Bleach (when needed)	Iron-Dry or Steam Temperatures			Line Dry/ Hang to Dry
	Only Non-Chlorine (color-safe) Bleach (when needed)		High		Drip Dry
Tumble Dry Cycle			Medium		Dry Flat
	Normal		Low		
	Permanent Press/ Wrinkle Resistant/ Wrinkle Control	Dryclean			
	Gentle/ Delicates		Dry clean		
			Do Not Dry clean		

\*\*The dot symbols represent appropriate wash water temperatures for various items. The temperature range for Hot is 105° - 125° F/ 41° - 52°C, for Warm 85° - 105° F/29° - 41° C and for Cold 60° - 85° F/16° - 29° C.

(Wash water temperature must be a minimum of 60° F/16°C for detergent activation and effective cleaning.)

The clothes Washer may not ensure these temperatures because the actual water temperatures entering your Washer are dependent on water heater settings and regional water supply temperatures. For example, cold water entering the home in the northern states during winter may be 40° F/4° C which is too cold for effective cleaning. The water temperature in this situation will need to be adjusted by selecting a warm setting, adding some hot water to the MAX FILL line or using your Washer's heating option, if available.

---

## 14-4. ELECTRICAL WARNINGS

---

To reduce the risk of fire, electrical shock, and other injuries, keep these safety precautions in mind:

- Operate the appliance only from the type of power source indicated on the marking label.  
If you are not sure of the type of power supplied to your home, consult your appliance dealer or local power company.
- Use only a grounded or polarized outlet. For your safety, this appliance is equipped with a polarized alternating current line plug having one blade wider than the other.  
This plug will fit into the power outlet only one way. If you are unable to insert the plug fully into the outlet, try reversing the plug. If the plug still doesn't fit, contact your electrician to replace your outlet.
- Protect the power cord. Power supply cords should be routed so that they are unlikely to be walked on or pinched by items placed on or against them. Pay particular attention to cords at plugs, convenience receptacles, and the point where they exit from the unit.
- Do not overload the wall outlet or extension cords. Overloading can result in fire or electric shock.

---

## 14-5. Models

---

Dealer	Models	Remark
<b>Lowe's</b>	WF326LAS	2(1200rpm), 6('06), L(Lowe's), A(Ag+), S(Silver)
	WF326LAW	2(1200rpm), 6('06), L(Lowe's), A(Ag+), W(white)
	WF316LAW	1(1100rpm), 6('06), L(Lowe's), A(Ag+), W(white)
	WF306LAW	0(1000rpm), 6('06), L(Lowe's), A(Ag+), W(white)
<b>BBY</b>	WF316BAC	1(1100rpm), 6('06), B(BBY), A(Ag+), C(Champagne)
	WF316BAW	1(1100rpm), 6('06), B(BBY), A(Ag+), W(white)
	WF306BAW	0(1000rpm), 6('06), B(BBY), A(Ag+), W(white)
	WF306BHW	0(1000rpm), 6('06), B(BBY), H(Ag+,Heater), W(white)
<b>Costco</b>	WF316CAW	1(1100rpm), 6('06), C(costco), A(Ag+), W(white)
	WF306C1W	0(1000rpm), 6('06), C(costco), 1(grade), W(white)

---

**14-5. Q & A**

---

<b>NO.</b>	<b>Question</b>	<b>Answer</b>
1	How long does it take for the door to unlock?	It takes approximately 2-3 seconds for the door to unlock.
2	The cycle is complete and "End" is displayed. How do I set another cycle?	When "End" is displayed, the Power button should be pressed or door should be opened before selecting another cycle. The display will show "End" until washer is turned off. To turn off washer, the Power button should be pressed or the door should be opened
3	What should I do when Information Code ("dc") lights up?	When the Information Code is displayed, press the Start/Pause dial and then restart the cycle. For more information, refer to the Owner's Manual
4	There is a small amount of water left in Detergent Drawer after the load is complete. Is this normal?	It is normal for a small amount of water remaining in Detergent Drawer after it completes washing. Bleach is usually flushed out into the tub at the beginning of the washing. Also, its compartment is washed again during the following rinse cycle, removing any remnants.
5	When I went back to my washer, it was turned off. What happened?	Power button may have been accidentally bumped or pushed. Reset the cycle and start the washer. Make sure the unit is plugged into a live electrical outlet. Check house fuse or circuit breaker.
6	The washer door gets locked after a power failure. How can I open it?	If the power fails while the door is locked, the door will remain locked until the power comes back on. If the power comes back on while the door is still locked, the cycle will resume where it left off. If the door is unlocked, "PF" will display and the washer will pause. Press Power Off and restart the cycle.
7	The washer door does not unlock when there is water in the tub. How can I open it?	The water must be drained from the tub for the door to be opened. Set the rotary dial to Spin Only and press the Start/Pause dial. The door will open 2-3 seconds after the Spin or Drain cycle is completed.

---

**Memo**

---



**ELECTRONICS**