

# Service

This manual is to be used by qualified appliance technicians only. Maytag does not assume any responsibility for property damage or personal injury for improper service procedures done by an unqualified person.

## 27" Front Load Washer

This Base Manual covers general information.

Refer to individual Technical Sheet for information on specific models.

This manual includes, but is not limited to the following:

**MAH9700AW\***

## Important Notices for Servicers and Consumers

Maytag will not be responsible for personal injury or property damage from improper service procedures. Pride and workmanship go into every product to provide our customers with quality products. It is possible, however, that during its lifetime a product may require service. Products should be serviced only by a qualified service technician who is familiar with the safety procedures required in the repair and who is equipped with the proper tools, parts, testing instruments and the appropriate service information. **IT IS THE TECHNICIANS RESPONSIBILITY TO REVIEW ALL APPROPRIATE SERVICE INFORMATION BEFORE BEGINNING REPAIRS.**



### **WARNING**

To avoid risk of severe personal injury or death, disconnect power before working/servicing on appliance to avoid electrical shock.

To locate an authorized servicer, please consult your telephone book or the dealer from whom you purchased this product. For further assistance, please contact:

### **Customer Service Support Center**

CAIR Center

**Web Site**

WWW.MAYTAG.COM .....

**Telephone Number**

1-800-688-9900

CAIR Center in Canada ..... 1-800-688-2002

### **Recognize Safety Symbols, Words, and Labels**

## **DANGER**

**DANGER**—Immediate hazards which **WILL** result in severe personal injury or death.



### **WARNING**

**WARNING**—Hazards or unsafe practices which **COULD** result in severe personal injury or death.



### **CAUTION**

**CAUTION**—Hazards or unsafe practices which **COULD** result in minor personal injury, product or property damage.



Important Information .....	2
Important Safety Information .....	4
General Information	
Model Identification .....	8
Serial Label Location .....	8
Model Nomenclature .....	9
Troubleshooting	
Troubleshooting General Symptoms .....	10
Component Testing Information	
Component Testing Information .....	21
Disassembly Procedures	
Top Removal .....	26
Water Level Sensor .....	26
Reactor Removal .....	27
EMI Filter .....	27
Water Valve Removal .....	28
Dispenser Removal .....	28
Console Removal .....	29
Door Removal .....	29
Front Panel Removal .....	31
Boot Removal .....	32
Heater Removal .....	32
Motor Removal .....	33
Drain Pump Removal .....	35
Outer Tub/Spinner Removal .....	36
Appendix A	
Installation Instructions .....	41
Appendix B	
Use And Care .....	49

# Important Safety Information



## WARNING

To reduce the risk of fire, electric shock, serious injury or death to persons when using your washer, follow these basic precautions:

- Read all instructions before using the washer.
- Refer to the Grounding Instructions in the Installation Manual for the proper grounding of the washer.
- Do not wash articles that have been previously cleaned in, washed in, soaked in, or spotted with gasoline, dry-cleaning solvents, or other flammable or explosive substances as they give off vapors that could ignite or explode.
- Do not add gasoline, dry-cleaning solvents, or other flammable or explosive substances to the wash water. These substances give off vapors that could ignite or explode.
- Under certain conditions, hydrogen gas may be produced in a hot water system that has not been used for two weeks or more. Hydrogen gas is explosive. If the hot water system has not been used for such a period, before using a washing machine or combination washer-dryer, turn on all hot water faucets and let the water flow from each for several minutes. This will release any accumulated hydrogen gas. The gas is flammable, do not smoke or use an open flame during this time.
- Do not allow children to play on or in the washer. Close supervision of children is necessary when the washer is used near children. This is a safety rule for all appliances.
- Before the washer is removed from service or discarded, remove the lid to the washing compartment.
- Do not reach into the washer if the wash tub is moving.
- Do not install or store the washer where it will be exposed to water and/or weather.
- Do not tamper with the controls.
- Do not repair or replace any part of the washer, or attempt any servicing unless specifically recommended in the User-Maintenance instructions or in published user-repair instructions that you understand and have the skills to carry out.
- To reduce the risk of an electric shock or fire, do not use an extension cord or an adapter to connect the washer to the electrical power source.
- Use your washer only for its intended purpose, washing clothes.
- Always disconnect the washer from electrical supply before attempting any service. Disconnect the power cord by grasping the plug, not the cord.
- Install the washer according to the Installation Instructions. All connections for water, drain, electrical power and grounding must comply with local codes and be made by licensed personnel

when required. Do not do it yourself unless you know how!

- To reduce the risk of fire, clothes which have traces of any flammable substances such as vegetable oil, cooking oil, machine oil, flammable chemicals, thinner, etc. or anything containing wax or chemicals such as in mops and cleaning cloths, must not be put into the washer. These flammable substances may cause the fabric to catch on fire by itself.
- Do not use fabric softeners or products to eliminate static unless recommended by the manufacturer of the fabric softener or product.
- Keep your washer in good condition. Bumping or dropping the washer can damage safety features. If this occurs, have your washer checked by a qualified service person.
- Replace worn power cords and/or loose plugs.
- Be sure water connections have a shut-off valve and that fill hose connections are tight. Close the shut-off valves at the end of each wash day.
- Loading lid must be closed any time the washer is in operational fill, tumble, or spin. Do not attempt to bypass the loading lid switch by permitting the washer to operate with the loading lid open.
- Always read and follow manufacturer's instructions on packages of laundry and cleaning aids. Heed all warnings or precautions. To reduce the risk of poisoning or chemical burns, keep them out of the reach of children at all times (preferably in a locked cabinet).
- Always follow the fabric care instructions supplied by the garment manufacturer.
- Never operate the washer with any guards and/or panels removed.
- Do not operate the washer with missing or broken parts.
- Do not bypass any safety devices.
- Failure to install, maintain, and/or operate this washer according to the manufacturer's instructions may result in conditions which can produce bodily injury and/or property damage.

**NOTE:** The Warnings and Important Safety Instructions appearing in this manual are not meant to cover all possible conditions and situations that may occur. Common sense, caution and care must be exercised when installing, maintaining, or operating the washer.

Always contact your dealer, distributor, service agent or the manufacturer about any problems or conditions you do not understand.

# Important Safety Information

## WARNING

To avoid personal injury or death from improper servicing, make sure you read and understand the descriptions and meaning of various safety symbols, words and labels used in this manual, before attempting any procedures described in the manual. Failure to understand and comply with safety information may result in severe personal injury or death.

### General Information

This Service Manual describes the operation, disassembly, troubleshooting, and repair of the Compact washer. It is intended for use by authorized technicians who troubleshoot and repair these units.

**NOTE:** It is assumed that users of this manual are familiar with the use of tools and equipment used to troubleshoot and repair electrical, and mechanical systems; and understand the terminology used to describe and discuss them.

### Related Publications

This is a base service manual, covering a range of similar models. It is intended to be used in conjunction with the Parts Manual and Technical Sheet covering the specific model being serviced.

## Electrical Service Information

### Proper Grounding and Polarization of 120 Volts Wall Outlets

For the safety of our customers and the Service Technician ALL appliances have a three-prong power cord and **MUST** be connected to a properly polarized AND grounded wall outlet.

This information was written for those who do not understand grounding and polarization of a wall outlet. A 120 volt wall outlet must always be wired as shown below.

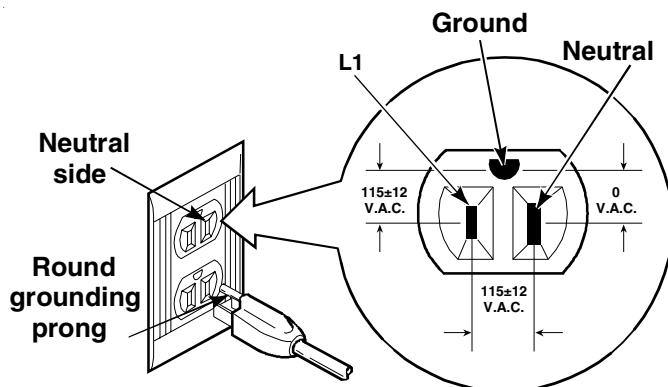

### About Ground Wires

In the event of an electrical short circuit, a ground wire reduces the risk of electric shock by providing an escape wire for the electric current.

Standard accepted color coding for ground wires is **green** or **green with a yellow stripe**.

Grounding wires and wires colored like grounding wires are **NOT** to be used as current carrying conductors.

## WARNING

To reduce the risk of fire, electric shock, serious injury or death, all wiring and grounding must conform with the latest edition of the National Electric Code, ANSI/NFPA 70, or the Canadian Electrical Code, CSA C22.1, and such local regulations as might apply. It is the customer's responsibility to have the wiring and fuses checked by a qualified electrician to make sure your home has adequate electrical power to operate the washer.

## WARNING

**To avoid risk of personal injury or death due to electrical shock:**

- **Observe all local codes and ordinances.**
- Disconnect electrical power to unit before servicing.
- Ground appliance properly.
- Check with a qualified electrician if you are not sure this appliance is properly grounded.
- DO NOT ground to gas line.
- DO NOT ground to cold water pipe if pipe is interrupted by plastic, nonmetallic gaskets, or other insulating (nonconducting) materials.
- DO NOT modify plug on power cord. If plug does not fit electrical outlet, have proper outlet installed by qualified electrician.
- DO NOT have a fuse in the neutral or ground circuit. A fuse in the neutral or ground circuit could result in an electrical shock.
- DO NOT use an extension cord with this appliance.
- DO NOT use an adapter plug with this appliance.
- DO NOT pinch power cord.

# Important Safety Information

## Explanation

**Polarization**—This means that the larger slot must be neutral and the small slot must be at line voltage.

**Mispolarized**—The outlet is incorrectly wired so that the larger slot is at line voltage and the smaller slot is neutral.

**Grounded**—This means the round hole connection is connected to earth ground through a connection to the main power panel.

**Ungrounded**—The round hole connection is not complete to earth ground and/or the main power panel.

## Grounding Instructions

### **WARNING**

- To avoid the risk of electrical shock or death, do not alter the plug.
- Do not remove grounding prong when installing grounded appliance in a home that does not have three wire grounding receptacle. Under no condition is grounding prong to be cut off or removed. It is the personal responsibility of the consumer to contact a qualified electrician and have properly grounded three prong wall receptacle installed in accordance with appropriate electrical codes.
- To avoid the risk of electrical shock or death, this equipment must be grounded.

This equipment **MUST** be grounded. In the event of an electrical short circuit, grounding reduces the risk of electric shock by providing an escape wire for the electric current. This unit is equipped with a cord having a grounding wire with a grounding plug. The plug must be plugged into an outlet that is properly installed and grounded.

Consult a qualified electrician or technician if grounding instructions are not completely understood, or if doubt exists as to whether the equipment is properly grounded. Do not use an extension cord. If the product power cord is too short, have a qualified electrician install a three-slot receptacle. This unit should be plugged into a separate 60 hertz circuit with the electrical rating as shown in the appropriate drawing. Models operate with a supply voltage of 120 Volts.

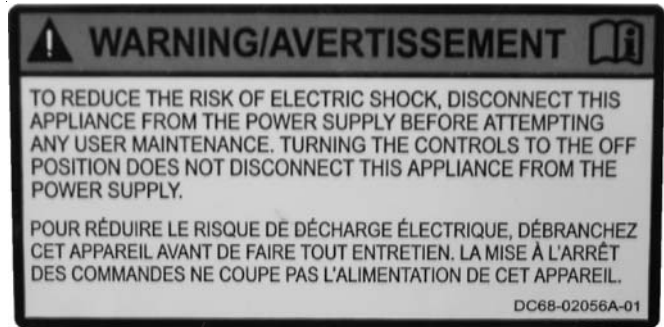

# Important Safety Information



**⚠ CAUTION/ATTENTION** 

- KEEP CLEAR ROTATING BELTS AND PULLEYS
- RESTEZ ÉLOIGNÉ DES COURROIES ET DES POULIES EN ROTATION

DC68-02004A-01



**⚠ WARNING/AVERTISSEMENT**

▶ THIS CONTROL BOARD IS INTENTIONALLY NOT GROUNDED AND MAY PRESENT A RISK OF ELECTRIC SHOCK ONLY DURING SERVICING. SERVICE PERSONNEL — DO NOT CONTACT THIS PART WHILE APPLIANCE IS ENERGIZED.

**DRAIN HOSE INSTALLATION / INSTALLATION DU TUYAU D'ÉVACUATION :** MAYTAG

▶ If the standpipe is less than 36" high, the drain hose must be routed through clip on the cabinet back to raise hose to proper height.

▶ Si la hauteur de la conduite verticale est inférieure à 36 po, il faut passer le tuyau d'évacuation dans l'attache à l'arrière de l'appareil.



CLIP/  
ATTACHE

▶ If an airtight connection between the drain hose and standpipe is demanded, an anti-siphon valve is needed.

▶ Si une connexion étanche est exigée entre le tuyau d'évacuation et la conduite verticale, il est alors nécessaire d'installer une soupape anti-siphonnement.

**WARNING**

**ELECTRICAL GROUNDING INSTRUCTIONS**

THIS APPLIANCE IS EQUIPPED WITH A THREE-PRONG (GROUNDING) PLUG FOR YOUR PROTECTION AGAINST SHOCK HAZARD AND SHOULD BE PLUGGED DIRECTLY INTO A PROPERLY GROUNDED THREE-PRONG RECEPTACLE. DO NOT CUT OR REMOVE THE GROUNDING PRONG FROM THIS PLUG.

DC68-02004A-01



**⚠ WARNING**

**⚠ NEVER** ...reach into the washer until the tub has completely stopped spinning.

**⚠ NEVER** ...wash articles containing flammable fumes or materials like petroleum and cleaning products, cooking oils etc.

**⚠ NEVER** ...allow children to operate or play in, with or around the washer

# General Information

## Model Identification

Complete registration card and promptly return. If registration card is missing:

- For Maytag product call 1-800-688-9900 or visit the Web Site at [www.maytag.com](http://www.maytag.com)
- For product in Canada call 1-866-587-2002 or visit the Web Site at [www.maytag.com](http://www.maytag.com).

When contacting provide product information located on rating label. Record the following:

Model Number: \_\_\_\_\_  
Manufacturing Number: \_\_\_\_\_  
Serial or S/N Number: \_\_\_\_\_  
Date of purchase: \_\_\_\_\_  
Dealer's name and address: \_\_\_\_\_



Serial Label is located on the back of the unit and the front behind the door.



## Service

Keep a copy of sales receipt for future reference or in case warranty service is required. To locate an authorized technician:

- For Maytag call 1-800-462-9824 or visit the Web Site at [www.maytag.com](http://www.maytag.com).
- For product in Canada call 1-866-587-2002 or visit the Web Site at [www.maytag.com](http://www.maytag.com).

Warranty service must be performed by an authorized technician. We also recommend contacting an authorized technician, if service is required after warranty expires.

## Parts and Accessories

Purchase replacement parts and accessories over the phone. To order accessories for your product call:

- For Maytag product call 1-800-462-9824 or visit the Web Site at [www.maytag.com](http://www.maytag.com).
- For product in Canada call 1-866-587-2002 or visit the Web Site at [www.maytag.com](http://www.maytag.com).

## Extended Service Plan

We offer long-term service protection for this new washer.

- Dependability Plus™ Extended Service Plan is specially designed to supplement Maytag's strong warranty. This plan covers parts, labor, and travel charges.  
Call 1-800-925-2020 for information.





# General Information

## Washer Nomenclature

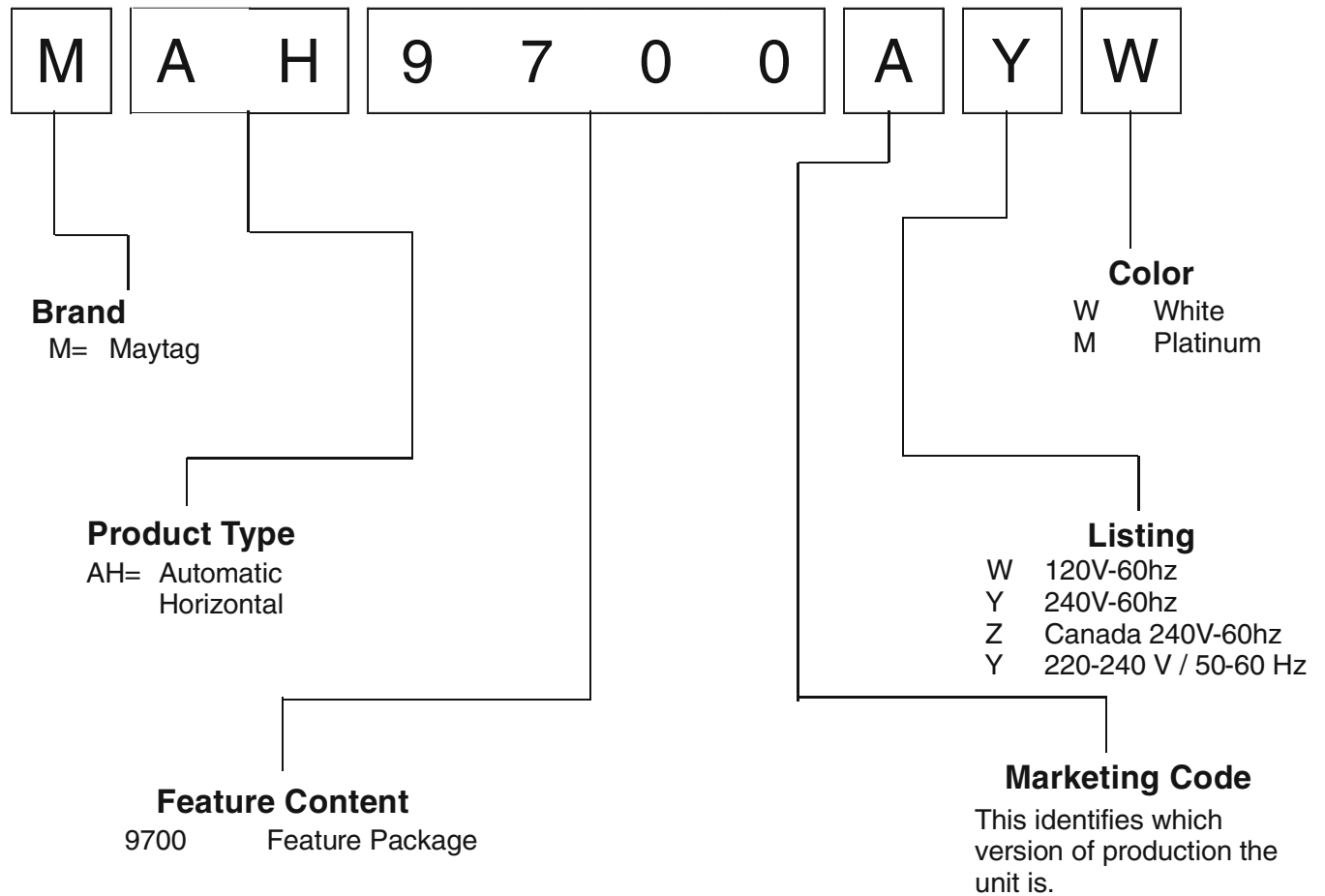

**Trouble Shooting and Diagnostic Guide is located behind the unit taped to the back.**



# Troubleshooting Procedures



## WARNING

To avoid risk of electrical shock, personal injury or death, disconnect power to unit before servicing, unless testing requires power.

Place washer into **Service Mode** and check for diagnostic codes. See **Technical Data Sheet** taped to rear panel.

### Will Not Start

- Plug cord into live electrical outlet. Check for proper voltage.
- Check fuse or reset circuit breaker.
- Push any key to turn on the clothes washer. Push the rotary selector knob to start the washer.
- Close door and push the rotary selector knob to start the clothes washer.
- Check to see if the washer is in a pause or soak period in the cycle. Wait briefly for machine to start. (If washer is in suds period, "SUDS" will display instead of remaining time.)
- Check for restricted drain system. During an electrical drain problem, "nd" error will occur after 15 minutes.
- Check water supply is working.
- Check water valve connections are good.
- Check the line filter and water valve filter.
- Check the machine control board terminal connections CN5, CN6 for good connections.
- Replace console control board.

CN9 pins 1 & 3 = 11.6ohms  $\pm 7\%$ ,  
Pins 1 & 2 = 11.6ohms  $\pm 7\%$ ,  
Pins 2 & 3 = 11.6 ohms  $\pm 7\%$

- Faulty Main Control Board.
- Faulty motor.

### Will Not Spin

- Check to make sure the door is fully closed.
- Check for water left inside the washer. If present, see **Will Not Drain**.
- Perform **Board Output Test** or **Quick Spin Test**. (Before test, make sure that the tumbler is empty.) If it doesn't tumble after the test above, check unbalanced load scenario, Main Control Board, and motor.
- Check for loose connections at Machine Control Board, Pressure Switch, Motor, Tach Harness and Motor Control. (CN8, CN9, CN3) Refer to the component testing procedure.
- Check motor winding resistance  
CN9 pins 1 & 3=11.6ohms  $\pm 7\%$ ,  
Pins 1 & 2=11.6ohms  $\pm 7\%$ ,  
Pins 2 & 3=11.6ohms.  $\pm 7\%$ .

### Leaking

- Check dispenser hose to outer tub for obstructions or restrictions.
- Make sure inlet hose connections are not leaking. Check for rubber gasket damage due to over-tightening of faucet couplers.
- Check standpipe for leak. Wrap a dry rag around the standpipe opening. If rag becomes wet, leak is fault of home plumbing. Be sure the standpipe is capable of accepting the incoming flow of water from the washer.
- Make sure end of drain hose is correctly inserted and secured to drain standpipe.
- Check internal hose connections (fill, drain systems, dispenser hoses & clamps).
- Check rubber boot. Remove, reposition and reinstall, if necessary.
- Check for possible kinked dispenser to outer tub hose. Hot water pressurization may force door open.

### No Water Fill

- Test water fill. Perform **Board Output Test**.
- Check to make sure water supply is turned on fully.
- Check electrical circuit and connections at the Water Valve, and Pressure Switch.
- Check for kinks in inlet hoses.
- Check for clogged inlet screens.
- Visually check hot, cold, bleach and softener water valves separately for fill.
- Check for low water pressure. May be dependent on pressure entering home. Variations may occur due to usage in the home at the time machine is used.
- Check for frozen pipes and hoses.
- Check resistance of Water Valve coils. (Normal 1.18Kohms; Check resistance of water valve coils. Check Pin #1 of CN5 and Pin # 1,2,3,4 of CN10.
- Check for loose connections at the Pressure Switch or on the Machine Control Board, CN3. (Refer to the component Testing procedure).

### No Tumble

- Start normal cycle with an empty machine and allow a fill to check tumble.
- Perform **Board Output Test**, or Quick Spin Test (Before test, make sure that the tumbler is empty.)
- Check for loose connections at Machine Control Board, Pressure Switch, Motor, Tach Harness and Motor Control. (Refer to the component testing procedure)
- Check motor windings resistance.

### Tub Full of Suds

- Check for restricted drain system. See **Will Not Drain** and **Will Not Spin**.
- Check for loose wire connections at Control

# Troubleshooting Procedures



## WARNING

To avoid risk of electrical shock, personal injury or death, disconnect power to unit before servicing, unless testing requires power.

Board and pump.

- Perform **Board Output Test**.
- Use high efficiency or low sudsing detergent specially formulated for front load washers.
- Reduce detergent amount for that specific load size and soil level. Towel loads have a minimal amount of soil present and typically create more suds.
- Run the clothes washer through another complete cycle using the coldest water, tablespoon of salt and no detergent.

### Wet Clothes

- Very small clothes loads can cause unbalanced loads. Add additional towels.
- Excessive suds may have been present, due to not using High-Efficiency detergent. Reduce amount of detergent usage.
- See **Will Not Spin**.
- Low Spin Speed or Drain Only was selected.

### Will Not Lock

- Door not all the way closed or not properly aligned. Possible laundry load is too large to close door.
- Place washer into **Service Mode** and check for diagnostic codes 4,18 & 22.
- Perform **Board Output Test**. Check door lock system. Check the output voltage of Door Lock Coil. If normal, change door Lock switch, If not normal, change Main Control Board. (Refer to the Component Testing procedure.)
- Check electrical connections at lock switch assembly and machine control board (CN5 and CN9). (Refer to the Component Testing procedure.)

### Will Not Unlock

- Push door closed to make sure nothing from inside is pressing against it, which may keep it from unlocking.
- Door locked from water level too high. Opening door will result in water draining from door opening.
- Check for water remaining in the tub. Check the temperature inside the drum is higher than 50°C/122°F. If water is present inside drum, refer to "**Will not drain**", If there is no problem with temperature, check wiring of Main Control Board and Door Lock Switch.
- Drain manually by removing drain hose clamp.
- Display shows **LO**. Press power **Off** Key to turn off the washer and unplug and reconnect washer. Press any key to turn on the washer.

If **LO** is displayed, Main Control Board and Door Lock Switch should be checked.

- Place washer into **Service Mode** and check for diagnostic codes 4,18 & 22.
- Check electrical connections at lock switch assembly and Machine Control Board (CN10). (Refer to the component Testing procedure.)
- Perform **Board Output Test**. Check door lock system for loose connections.
- Perform **Board Output Test**. Check door lock system. Check the output voltage of Door Lock Coil If 120V present change door Lock switch, If not present, change Main Control Board. (Refer to the component Testing procedure.)

### Will Not Drain

- Check for restricted drain system.
- In cold climates check for frozen drain hose.
- Check for 120 VAC at the pump when a spin cycle is selected.
- Check pump motor winding resistance. (14.2 ±7% ohms)
- Check that the machine control correctly senses the water level in the washer. See **Board Input Test**.
- Go to **Board Output Test** and perform Pump Out Test.
- Check the Machine Control Board connections at CN10 (Pin 6) for the pump. Should see 110-120VAC.(Refer to the component testing procedure).
- Check tub to pump hose for twist in hose.

### Wrong Water Temperature

- Check that both faucets are turned on fully.
- Make sure water heater is set to deliver a minimum of 120°F (49°C) hot water at the tap. Also check water heater capacity and recovery rate.
- If the water heater is located a long distance from washer, the water line may need to be purged prior to starting wash cycle.
- Too Hot/Too Cold: This washer uses a reduced amount of water, while the control board meters the incoming flow to regulate the actual temperature of the water in the tub. This may appear to be significantly warmer/cooler than expected.
- Make sure the temperature selection is correct.

# Troubleshooting Procedures



## WARNING

To avoid risk of electrical shock, personal injury or death, disconnect power to unit before servicing, unless testing requires power.

- Disconnect inlet hoses from the Water Valve and clean the valve screens of any debris.

### Noisy and/or Vibration/Walking

- Check if the washer was properly leveled and the locking nuts are securely tightened up against the base frame of the washer.
- Check and determine all four of the shipping bolts and spacers have been fully removed from the rear panel of the washer.
- Check for proper load size and distribution. If clothes load is too small, add a few towels to balance the clothes load better.
- Check the tightness of the rear pulley bolt. Tighten if necessary.
- Clean floor and bottom side of washer feet. Check clearance. Refer to the back of machine and Installation Instruction.

### Rubber Feet Leaving Marks on Floor

- Use a pencil eraser to remove mark.
- Walk washer into location, do not drag.

### Additive Cups Full of Water

- Small amount of water in bottom of additive cups is normal.
- Remove and wash Dispenser Tray, removable Cup, and Rinse Cap.
- Level washer.

### Buttons do not Respond

- Option and Function buttons respond differently according to each cycle.
- Child Lock feature has been selected. To disable feature press and hold **Wash/Rinse Temp** and **Spin Speed** simultaneously until a beep is heard.
- When display shows "**End**", only the **Power Off** button will function. Press **Power Off** and make new cycle selections.

### Consumer Information Codes

If the consumer observes codes on display, see table below.

LED Display	Description	Diagnostic code
nd	The water level fails to drop below the Low Water level reset within 15 minutes, before a spin begins.	1
LO	Door failed to unlock after 3 attempts.	2
nF	Continuous fill of 12minutes. Total fill of 14minutes.	3
FL	Door failed to lock after 3 attempts.	4
LE	Water sensor level fault.	8
OE	A fault is detected in the water level sensor. Data (frequency) shows the water level is at or above the overflow level.	E
E2	Detected a key pressed more than 30seconds, the key will be assumed to be stuck.	15
dc	Never exceeded 400rpm due to an unbalanced load.	10
od	The door has not been opened after two complete wash cycles. Door switch was not seen open since the last two final spins.	17

# Troubleshooting Procedures



## WARNING

To avoid risk of electrical shock, personal injury or death, disconnect power to unit before servicing, unless testing requires power.

LED Display	Description	Diagnostic code
dL	Open door lock switch with motor running.	18
dS	Door switch is read as open and the door locked switch is read as locked.	22
bE	Motor tach signal exists without motor running.	25
tE	Abnormal high/low temp or ohm resistance seen.	29
E3	Machine control is attempting to drive the motor but is not seeing any tach response. Visual check shows motor is not moving. (Locked, Hall Sensor fault)	2E
Sr	System Relay failure.	34
Hr	Heater Relay failure.	36
3E	Over Current is detected. Motor won't turn.	3E
2E	Voltage for motor control bus is over specified limit.	91
2E	Voltage for motor control bus is under specified limit.	92

### Service Mode

Service Mode enables service personnel to verify the operation of the washing machine and diagnose problems. Service Mode can be entered in the middle

of any wash cycle without interrupting the cycle. While in Service Mode, the technician can cancel the current cycle, set a continuous running mode, start a variety of special service tests and view diagnostic displays.

### Enter / Exit Service Mode

To enter Service Mode press the **Chime** and **Extra Rinse** keys for three seconds or until the control beeps.

**NOTE:** The washer must be on before Service Mode can be entered.



The motor speed will be displayed when started (motor not running display will be 0). The present state of the machine will not be changed (i.e., the current cycle in progress will not be interrupted and only the display will change). All LED's will be turned off except the "Door Lock" LED. It will continue to display the condition of the door lock.

To exit:

- 1) Press **Chime** and **Extra Rinse** keys for 3 seconds again, or
- 2) Press **Off**, or
- 3) Unplug the machine. Pressing the **Rotary Selector** knob while running a test will pause the individual test, while remaining in Service Mode.

The following table summarizes special tests and features available in Service Mode, along with methods of activation and cancellation.

### Access Service Tests and Diagnostic Features while in Service Mode.







Test or Display	Press LED to Start	Press LED to Cancel
 <b>Quick Spin Test</b>	Press <b>Delay Start</b> and <b>Rinse&amp;Spin</b>	Press <b>Delay start</b> and <b>Rinse&amp;Spin</b> Press <b>Off</b> (exits Service Mode)
 <b>Hold Quick Spin Step</b> (holds predefined RPM)	Press <b>Rotary Selector</b> (during test)	Press <b>Rotary Selector</b> (cancels hold & resumes next step)

# Troubleshooting Procedures



## WARNING

To avoid risk of electrical shock, personal injury or death, disconnect power to unit before servicing, unless testing requires power.

Test or Display	Press LED to Start	Press LED to Cancel
 <b>Fast Time-Down / Advance to Next Step</b>	Press <b>Temperature</b> to start test. Press <b>Temperature</b> during cycle to advance.	Press <b>Power Off</b>
 <b>Quick Service Cycle</b>	Press <b>Temperature</b> and <b>Soil Level</b>	Press <b>Off</b> (also exits Service Mode)
<b>Hold Quick Service Cycle Step</b>	Press <b>Rinse&amp;Spin</b> and <b>Spin Only</b> together	Press <b>Rinse&amp;Spin</b> and <b>Spin Only</b> to resume
 <b>LED/Switch Test</b>	Press <b>Delay</b> for 3 seconds (then individual buttons to test) Rotate Cycle Selector clockwise, the LED's around it will be toggled. Rotate counterclockwise, the 7-segment LED's toggle. Press Rotary Cycle Selector, all of the LED's around the Rotary Cycle Selector will be toggled.	Press <b>Off</b> twice after starting test
 <b>Board Input Test</b>	Press <b>Spin Only</b>	Press <b>Spin Only</b>
 <b>Board Output Test / System Check</b>	Press <b>Spin Speed</b>	Press <b>Off</b>
 <b>Diagnostic Code Display (Initial)</b>	Press <b>Rinse&amp;Spin</b> – displays "d"	Press <b>Rinse&amp;Spin</b> again

Test or Display	Press LED to Start	Press LED to Cancel
<b>All Diagnostic Codes</b>	Rotate <b>Cycle Selector</b> either direction	N/A
<b>Cycle Count No. for Diagnostic Code</b>	Press and hold <b>Rotary Selector</b> , while diagnostic code is displayed	Release <b>Rotary Selector</b> (returns to diagnostic code display)
<b>Clear All Diagnostic Codes</b>	Press <b>Delay</b> and <b>Chime</b> together while displaying diagnostic codes	
<b>Display Software Version</b>	Press <b>Soil Level</b> . Press 2 times for displays with only 2 character positions.	Press <b>Soil Level</b> a 3 <sup>rd</sup> time
<b>Cycle Count</b>	Press <b>Chime</b>	

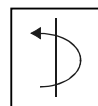

### Quick Spin Test

While in Service Mode, press **Delay** and **Rinse&Spin** keys to start a Quick Spin Test. Quick Spin test steps are as follows:

- Start spinning and after reaching a maximum spin speed.
- stay at maximum spin speed for 2 minutes and stop Quick Spin Test.



### Hold Quick Spin Step

If the Rotary Selector key is pressed during the Quick Spin test, the machine will hold at the next highest index speed for up to 10 minutes. At the end of 10 minutes, the machine will resume and finish the Quick Spin test. To cancel the Hold and allow the Spin Test to continue, press the **Delay** and **Rinse&Spin** keys.

# Troubleshooting Procedures



## WARNING

To avoid risk of electrical shock, personal injury or death, disconnect power to unit before servicing, unless testing requires power.



### Fast Time Down Test

While any test or cycle is running in Service Mode, pressing the *Temperature* key will advance the program to the next cycle stage.

Cycle stages are located at key locations in the machine operation. As the program is advanced it will index as follows: The end of each fill (the same as the beginning of a tumble session for Wash, or Rinse); at the beginning of a drain session; at the beginning of a spin session (at this position, check the water level, if over reset level, drain first before entering the spin function); at the beginning of a fill session; at the beginning of Bleach fill; at the beginning of Fabric Softener fill; and every 3 minutes during the tumble sessions (Wash, and Rinses).



### Quick Service Cycle

While in Service Mode, pressing the *Temperature* and *Soil Level* key for 3seconds will start a Quick Service Cycle.

This will be a quick check of all systems. If display shows **od** then open and close door. Pressing *Spin Speed* will advance to the next cycle. The following steps are performed: Display shows **“SC”**.

1. Hot water for 5 seconds and then turn off.
2. Cold water for 5 seconds and then turn off.
3. Bleach valve for 5 seconds and then turn off.
4. Dispenser softener using cold water and bleach water for 5 seconds and then turn off.
5. Turn on Cold valves until the control detects proper water level. During this time, tumble at 45 rpm for 5seconds in a clockwise direction, pause for 2seconds, tumble at 45 rpm for 5 seconds in a counterclockwise direction, pause for 2 seconds. Continue pattern until the water level is detected. Minimum time for this segment to be 5 seconds. After water height is achieved, continue tumble pattern for another 14 seconds. If the washer is equipped, turn on heater for first 5 seconds of this tumble pattern. Advance the washer to next step if water is not connected to machine.
6. Drain and spin to maximum speed. Machine will achieve maximum speed using the safest, fastest method.
7. Display a **“PA”** (Passed) continuously for 5 seconds I no diagnostic codes were logged during the test. Washer will return to the normal Service Mode at the end of the 10 second period.

The **“SC”** in the display will blink as an indication of failure, and continue blinking until the quick service cycle test has reached the end. Any diagnostic code logged during this test will result in failure of the test, but will not necessarily stop the test. During the Quick Service Cycle, pressing the *Spin Speed* key will

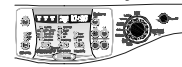

advance to the next step. Pressing the *Rinse&Spin* and *Spin Only* keys will suspend the machine at

the current step for up to 10 minutes or until *Delay Start* and *Chime* are pressed again. All LED's should flash on and off while the system is suspended or on hold.

### LED/Switch Test

While in Service Mode, press the *Delay* key to start a LED/Switch check. All the LED's can be toggled or slewed by pressing the key associated with the LED or set of LED's. All keys (including the **OFF** button) must be pressed within 5 minutes for this test to pass. **“PA”** will be displayed for five (5) seconds once all keys have been pressed and the test is completed. Following 20seconds of inactivity at any point, this test will exit without any display. The *Power Off* switch pad must be pressed twice within 30 seconds to cancel this test.

Switch	Action
Delay Start	Press once
Chime	Press 3 times
Extra Rinse	Press once
Soil Level	Press 4 times
Spin Speed	Press 5 times
Temperature	Press 5 times
Rinse&Spin	Press once
Spin Only	Press once
Prewash	Press once
Extended Spin	Press once
Selector Knob	Rotate 1 full revolution clockwise
Selector Knob	1 position counterclockwise
Start Pause	Press once
Selector Knob	Press once
Power Off	Press once

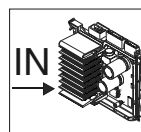

### Board Input Test

- While in Service Mode, pressing the *Spin Only* key will begin the **Board Input Test**. This test turns on a specified output after a key press. Pressing the *Spin Only* key again cancels the test.(Display shows

# Troubleshooting Procedures



## WARNING

To avoid risk of electrical shock, personal injury or death, disconnect power to unit before servicing, unless testing requires power.

in). While in Service Mode follow chart to check respective function.

- When the “Rotary Cycle Selector” is set to “**Super Wash**” and the “**Rotary Cycle Selector**” is pressed, the door position will be displayed: “**OP**” if open, “**CL**” if closed.
- When the “Rotary Cycle Selector” is set to “**Normal**” and the “**Rotary Cycle Selector**” is pressed, the Lock position will be displayed: “**UL**” if unlocked, “**LO**” if locked.
- When the “Rotary Cycle Selector” is set to “**Whites**” and the “**Rotary Cycle Selector**” is pressed, the High water level will be displayed: “**0**” if below level, “**1**” if above level. The High water level is defined as the over flow water level.
- When the “Rotary Cycle Selector” is set to “**Wrinkle Control**” and the “**Rotary Cycle Selector**” is pressed, the Medium water level will be displayed: “**0**” if below level, “**1**” if above level. The Medium water level is defined as the minimum water level needed to turn the heater on.
- When the “Rotary Cycle Selector” is set to “**Colors**” and the “**Rotary Cycle Selector**” is pressed, the Low water level will be displayed: “**0**” if below level, “**1**” if above level. The Low water level is defined as the reset water level.
- When the “Rotary Cycle Selector” is set to “**Hand Wash**” and the “**Rotary Cycle Selector**” is pressed, the level of Tub unbalance will be displayed: “**UC**” if balanced, “**UO**” if unbalanced. “**UO**” will be displayed during the time when the machine is correcting for the unbalance; e.g. slowing down to redistribute the load or to get to a lower spin speed. Once the situation has been corrected (i.e. the load has begun tumbling or the lower speed has resulted in an acceptable amount of balance); “**UC**” will once again be displayed.
- When the “**Delay**” switch pad is pressed, the water temperature will be displayed in Degrees F.
- When the “Rotary Cycle Selector” is set to “**Delicates**” and the “**Rotary Cycle Selector**” is pressed, the water temperature will be displayed in degrees C (Celsius).

While in Service Mode follow chart to check respective function.

Selection	Function	Display
Rotary cycle selector set to Super Wash. Press Rotary Selector Knob.	Door position	“ <b>OP</b> ” or “ <b>CL</b> ”
Rotary cycle selector set to Normal. Press Rotary Selector Knob.	Lock state	“ <b>UL</b> ” or “ <b>LO</b> ”
Rotary cycle selector set to Whites. Press Rotary Selector Knob.	High water level	“ <b>0</b> ” if below level. “ <b>1</b> ” if above level.
Rotary cycle selector set to Wrinkle Control. Press Rotary Selector Knob.	Medium water level	“ <b>0</b> ” if below level. “ <b>1</b> ” if above level.
Rotary cycle selector set to Colors. Press Rotary Selector Knob.	Low water level	“ <b>0</b> ” if below level. “ <b>1</b> ” if above level.
Rotary cycle selector set to Hand Wash. Press Rotary Selector Knob.	Tub balance	“ <b>UC</b> ” Balanced “ <b>UO</b> ” Unbalanced
Press Delay switch pad.	Water temperature	Degrees F
Rotary cycle selector set to Delicates. Press Rotary Selector Knob.	Water temperature	Degrees C

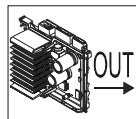

### Board Output Test

While in Service Mode, pressing the **Spin Speed** key will begin the Board Output Test. This test turns on a specified output after a

key press. Pressing the **Spin Speed** key again cancels the test. Only one output can be “on” at any time. All outputs will be turned off after five (5) minutes of inactivity.

While in Service Mode follow to check respective function.

- When the “Rotary Cycle Selector” is set to “**Super Wash**” and the “**Rotary Cycle**



# Troubleshooting Procedures



## WARNING

To avoid risk of electrical shock, personal injury or death, disconnect power to unit before servicing, unless testing requires power.

- **Select** button is pressed, the Main relay will be toggled (either from “on” to “off” or from “off” to “on”).
- When the “Rotary Cycle Selector” is set to **Normal** and the **Rotary Cycle Selector** button is pressed, the hot water valve will be turned on. This output will remain on until the **Rotary Cycle Selector** button is pressed again to turn off the output. The control will not allow the machine to fill past the High water level.
- When the “Rotary Cycle Selector” is set to **Wrinkle Control** and the **Rotary Cycle Selector** button is pressed, the cold water valve will be turned on. This output will remain on until the **Rotary Cycle Selector** button is pressed again to turn off the output. The control will not allow the machine to fill past the High water level.
- When the “Rotary Cycle Selector” is set to **Delicates** and the **Rotary Cycle Selector** button is pressed, the bleach valve will be turned on. This output will remain on until the **Rotary Cycle Selector** button is pressed again to turn off the output. The control will not allow the machine to fill past the High water level.
- When the “Rotary Cycle Selector” is set to **Hand Wash** and the **Rotary Cycle Selector** button is pressed, the pre wash valve will be turned on. This output will remain on until the **Rotary Cycle Selector** button is pressed again to turn off the output. The control will not allow the machine to fill past the High water level.
- When the “Rotary Cycle Selector” is set to **Quick Wash** and the **Rotary Cycle Selector** button is pressed, the drain pump will be turned on. This output will remain on until the **Rotary Cycle Selector** button is pressed again to turn off the output.
- Pressing the **Delay** switch pad will turn on the motor and the “Delay” LED. This output and the LED will remain on until the **Delay** switch pad is pressed again to turn off the output. When activated, the machine will tumble for 5 seconds in the CW direction, pause for 2seconds, tumble in the CCW direction for 5 seconds, pause for 2 seconds; repeating this pattern until **Delay** button is pressed again to turn off the tumbling. Note that all tumble speeds are assumed to be 45 rpm.
- Pressing the **Chime** switch pad will unlock the door and turn on the all the LED’s above the “Chime” button. This output will attempt to unlock one time, if safe to do so.
- Pressing the **Temperature** switch pad will lock the door and all the Temperature LED’s will turn ON. Pressing the **Chime** button will unlock the door and the all the Chime LED’s will turn ON.
- When the “Rotary Cycle Selector” is set to **Colors** and the **Rotary Cycle Selector** is pressed, the bleach valve and the cold water valve will be turned on to check the fabric softener fill. This output will remain on until the **Rotary Cycle Selector** button is pressed again to turn off the output. The control will not allow the machine to fill past the High water level.
- When the **Rinse & Spin** keypad is pressed, the Heater will be turned on if the water level is above the Heater Safety Level. If the water level is below the Heater Safety Level, a warning beep will be given and the heater will not be turned on. The Heater output will remain on until the **Rinse & Spin** keypad is pressed again to turn off the output.

Selection	Component	Function
Rotary cycle selector set to Super Wash. Press Rotary Selector Knob.	Main Relay	On to Off or Off to On
Rotary cycle selector set to Normal. Press Rotary Selector Knob.	Hot Water Valve	1 <sup>st</sup> press valve on. 2 <sup>nd</sup> press valve off.
Rotary cycle selector set to Wrinkle Control. Press Rotary Selector Knob.	Cold Water Valve	1 <sup>st</sup> press valve on. 2 <sup>nd</sup> press valve off.
Rotary cycle selector set to Delicates. Press Rotary Selector Knob.	Bleach Valve	1 <sup>st</sup> press valve on. 2 <sup>nd</sup> press valve off.
Rotary cycle selector set to Hand Wash. Press Rotary Selector Knob.	Pre Wash Valve	1 <sup>st</sup> press valve on. 2 <sup>nd</sup> press valve off.

# Troubleshooting Procedures



## WARNING

To avoid risk of electrical shock, personal injury or death, disconnect power to unit before servicing, unless testing requires power.

Selection	Component	Function
Rotary cycle selector set to Quick Wash. Press Rotary Selector Knob.	Drain Pump	1 <sup>st</sup> press Drain Pump on. 2 <sup>nd</sup> press Drain Pump off.
Press Delay switch pad	Motor	1 <sup>st</sup> press Motor on. 2 <sup>nd</sup> press Motor off.
Press Chime switch pad	Door Lock	1 Attempt to unlock
Press Temperature switch pad	Door Lock	Lock Door
Rotary cycle selector set to Colors. Press Rotary Selector Knob.	Bleach Valve and Cold Water Valve	1 <sup>st</sup> press Fabric Softener fill. 2 <sup>nd</sup> press valves off
Press Rinse & Spin switch pad	Heater	1 <sup>st</sup> press heater on. 2 <sup>nd</sup> press heater off.

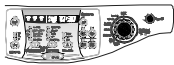

### Display Diagnostic Codes

The diagnostic code display can be toggled on and off from Service Mode by pressing the **Rinse & Spin** key and rotating the cycle select knob. The display will show a "d". Rotating the Cycle Selector knob in either direction will cycle through the list of codes one code at a time with no wrap. Once an initial direction is selected by the user (either Clockwise or Counterclockwise), subsequent movements of the knob in the same direction will show older codes. If the user changes direction and turns the knob in the opposite direction, the more recent code will be displayed. If rotation is continued to the limits of the list, the display will remain at the top or the end of the list. A pair of dashes "- -" will be displayed at the end of the list of codes, when the control reaches the top, it will again show "d". A code generated during the current cycle will be displayed with the Spin Indicator LED turned "ON". If no cycle is currently running, a code generated during the previous cycle will be displayed with the Spin Indicator LED turned "ON".

Access Other Features While a diagnostic code is displayed, if the Rotary Selector is pressed and held, the machine will display the number of cycles since the diagnostic code occurred. To clear the diagnostic list press the Delay and Chime keys for 3 seconds while viewing the list.

A code generated during the current cycle will be displayed with the Spin Indicator LED turned "ON". If no cycle is currently running, a code generated during the previous cycle will be displayed with the Spin Indicator LED turned "ON".

### Cycle Count Since A Diagnostic Code Occured/Clearing Diagnostic Codes

While a diagnostic code is displayed, if the **Rotary Selector** is pressed and held, the machine will display the number of cycles since the diagnostic code occurred. To clear the diagnostic list press the **Delay** and **Chime** keys for 3 seconds while viewing the list.

### Diagnostic Codes

Diag. Code	Description	Trigger	Action to be taken
1	No Drain	The water level fails to drop below the Low Water level reset within 15 minutes, before a spin begins.	Displays "nd" Go to "Will Not Drain" Troubleshooting Section
2	The door fails to unlock	Door failed to unlock after 3 attempts	Displays "LO" Go to "Will Not Unlock" Troubleshooting Section
3	No Fill	Continuous fill of 12 minutes. Total fill of 14 minutes.	Displays "nF" Go to "No Water Fill" Troubleshooting Section
4	The door fails to lock	Door failed to lock after 3 attempts	Displays "FL" Go to "Will not lock" Troubleshooting Section.
5-7	Not Used		

# Troubleshooting Procedures



## WARNING

To avoid risk of electrical shock, personal injury or death, disconnect power to unit before servicing, unless testing requires power.

Diag. Code	Description	Trigger	Action to be taken
8	Water level sensor fault.	Input signal from water level Sensor is out of range, Washer will beep and pause the wash cycle.	Displays " <b>LE</b> " Go to "No water fill Troubleshooting".
9	Not Used		
10	Unbalance detected during final spin, which prevented the spinner from exceeding 400 rpm	Never exceeded 400rpm due to an unbalance load.	LED – Will display " <b>dc</b> " Go to "Wet Clothes Troubleshooting Section"
E	Water sensor level fault.	Water level in the machine is believed to be above the overflow level. When this condition is detected, the machine will automatically begin pumping water out of the machine until it falls below the overflow level.	First check to see that water valve is not stuck. If water valve is OK, check water level sensor
11	Will not remember machine settings	Difficulty in reading memory	Go to " <b>Clear diagnostic codes</b> " Disconnect and reconnect the washer power cord at power supply outlet. If condition still exists, replace machine control board.
12-14	Not Used		

Diag. Code	Description	Trigger	Action to be taken
15	Stuck Key	A key is sensed to be pressed more than 30 seconds, the key will be assumed to be stuck	Display " <b>E2</b> ". Go to " <b>Membrane Pad Check</b> " Check connection of keypad to control board. Replace LED Board if necessary.
17	Door switch was not seen open since the last three final spins	The door has not been opened after two complete wash cycles. Door switch was not seen open since the last two final spins	Will display " <b>od</b> " If door open sensing, will cleared.
18	Detected door lock switch open during cycle when not expected.	Open door lock switch with motor running.	Check for loose wire connections Clear the diagnostic code and recheck; if reoccurs, perform Diagnostic Motor/Machine Control Board test Check for faulty motor relay on the machine control board.
19-21	Not Used		
22	Door switch detected open during cycle (when not paused).	Door switch is detected open and the door locked switch is read as locked.	Go to " <b>Door Lock Test</b> " Troubleshooting Section
23-24	Not Used		

# Troubleshooting Procedures



## WARNING

To avoid risk of electrical shock, personal injury or death, disconnect power to unit before servicing, unless testing requires power.

Diag. Code	Description	Trigger	Action to be taken
25	Motor tach signal exists without motor running.	Tach signal exists without torque command or when not expected (Abnormal condition only).	Displays " <b>bE</b> ". Replace Machine Control Board.
26-28	Not Used		
29	Sump thermistor failure (Optional)	Abnormal high/low temp or ohm resistance seen	Displays " <b>tE</b> ". - Loose or pinched wires - Bad sump thermistor
30-33	Not Used		
2E	Motor Drive failure (Locked, Hall sensor fault)	Machine control is attempting to drive the motor but is not seeing any tach response. Visual check shows motor is not moving.	Display " <b>E3</b> " Evaluate wire harness for loose or unhooked connections. If machine has separate motor control, perform self diagnostic motor test. See " <b>Board Output Test</b> "
34	System Relay failure	Machine control does not see relay open when it should.	Display " <b>Sr</b> ". Replace machine control board.
35	Not Used		

Diag. Code	Description	Trigger	Action to be taken
36	Heater relay failure.	Heater Relay Check signal not sensed.	Display " <b>Hr</b> ". Replace Machine Control Board.
3E	Motor failure (Over current)	Over Current is detected. Motor won't turn.	Displays " <b>3E</b> ". Check the motor windings, the speed sensor, wiring connections, or Control Board.
40-49	Not Used		
91	Voltage for motor control bus is over specified limit	Voltage for motor control bus is over limit	Display " <b>2E</b> ". Replace Machine Control Board.
92	Voltage for motor control specified limit	Voltage for motor control bus is under specified limit	Display " <b>2E</b> ". Replace Machine Control Board.

### Exit Service Mode

To exit:





- 1) Press **Chime** and **Extra Rinse** keys for 3seconds again, or
- 2) Press Off, or
- 3) Unplug the machine. After five (5) minutes of inactivity (user key presses) in Service Mode, the machine will exit the Service Mode and resume normal operations. Pressing the **Off** key will completely exit Service Mode. If a cycle is running, cancel the cycle. Pressing the **Rotary Selector** knob while running a test will pause the individual test, while remaining in Service Mode. A power loss during Service Mode will cancel this mode.

# Component Testing Information

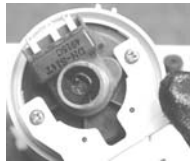

## WARNING

To avoid risk of electrical shock, personal injury or death, disconnect power to unit before servicing, unless testing requires power.

Illustration	Component	Test Procedure	Results
	Thermistor	Unplug harness connector and test from wire insertion side. Pin #6 and Pin #3 of CN3	13000 ohms @ 70F (2.5V DC)
	Door Switch	Unplug harness connector and test from wire insertion side.  Pin #7 of CN5 and Pin #3 of CN9 Pin #8 of CN5 and Pin #3 of CN9	60 ohms 60 ohms
	Water Sensor	Check voltage at Pin #6 and Pin #7 of CN3.  Check voltage at Pin #6 and Pin #8 of CN3.	Reset water level = 2.5V DC, 25.8 KHz  Reset water level = 2.5V DC, 25.8 KHz
	Sump Sensor	Check voltage at Pin #4 and Pin #2 of CN8.  Check voltage at Pin #4 and Pin #3 of CN8.	0V DC or 3.75V  0V DC or 3.75V
	Motor	Unplug harness connector and test from wire insertion side.  Pin #1 and Pin #2 of CN9 Pin #1 and Pin #3 of CN9 Pin #2 and Pin #3 of CN9	11.6 ohms 11.6 ohms 11.6 ohms
	Drain Pump	During drain check voltage at Pin #1 of CN5 and Pin #6 of CN10	120V AC
	Water Valves	Unplug harness connector and test from wire insertion side.  (Hot valve) Pin #2 of CN5 and Pin #2 of CN6 (Pre valve) Pin #3 of CN5 and Pin #2 of CN6 (Bleach valve) Pin #4 of CN5 and Pin #2 of CN6 (Main valve) Pin #1 of CN5 and Pin #2 of CN6	1100 ohms 1100 ohms 1100 ohms 1100 ohms
	Heater Relay	During water heat check voltage at Pin #1 of CN5 and Pin #2 of RY9	120V AC
	AC Power	Check voltage at Pin #1 and Pin #3 of CN5  Check voltage at Pin #1 of CN5 and Pin #1 of CN6	120V AC  120V AC
	Reactor	Unplug harness connector and test from wire insertion side.	Less than 1 ohm

# Component Testing Information

## **WARNING**

To avoid risk of electrical shock, personal injury or death, disconnect power to unit before servicing, unless testing requires power.

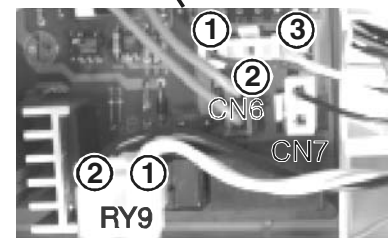
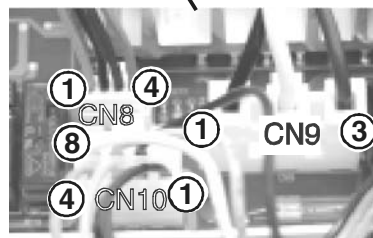
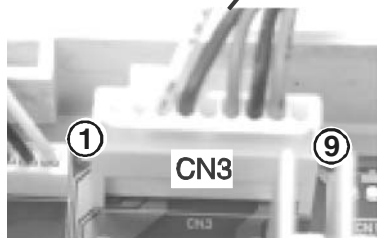
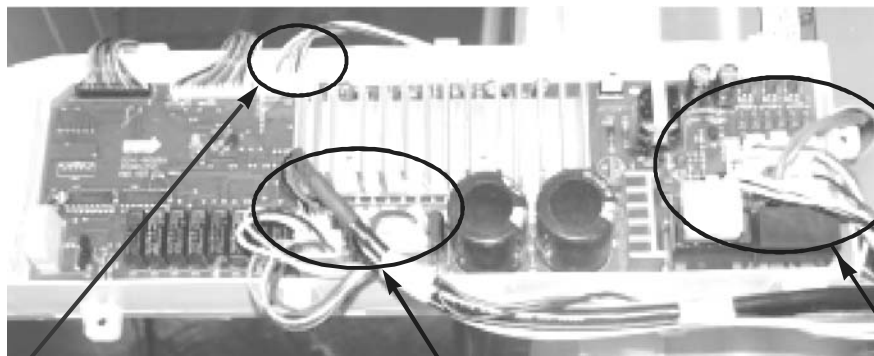
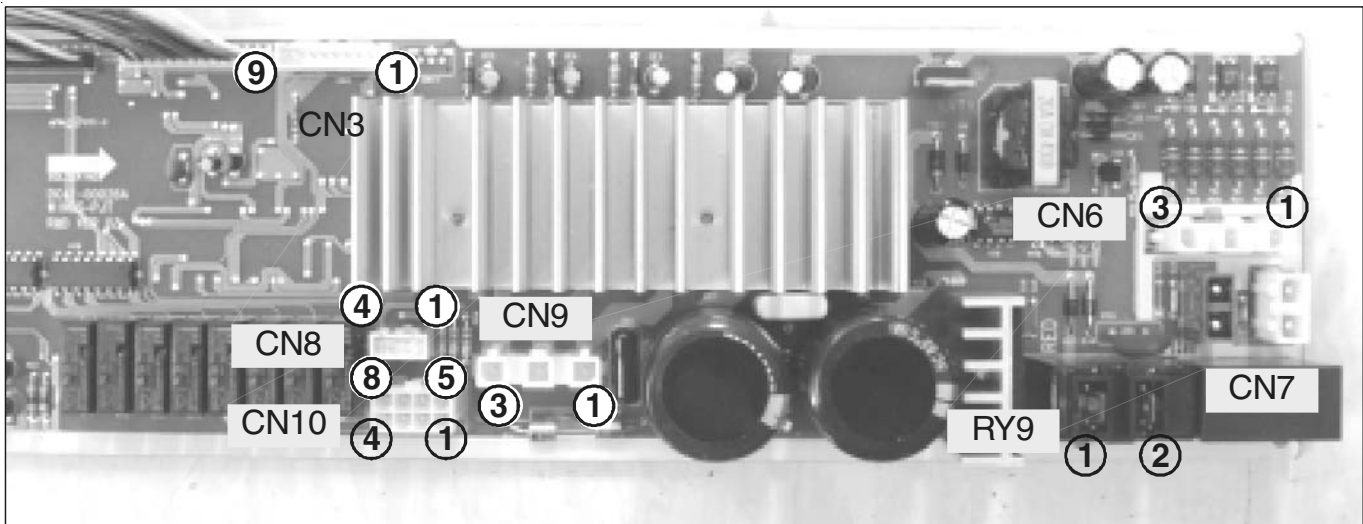

### **ATC Control**

When ATC cold wash is selected, the Heater turns on if the water temperature in the tub is below 60 degrees F. The heater turns off when the water temperature is above 70 degrees F or time has expired for the wash cycle. The cycle time will **not** be extended to reach the desired temperature.

When ATC warm wash is selected, the heater turns on if the water temperature in the tub is below 95 degrees F. The heater will turn off when the water temperature is above 105 degrees F or time has expired for the wash cycle. The cycle time will **not** be extended to reach the desired temperature.

When hot wash is selected, the heater will turn on if the water temperature in the tub is below 120 degrees F. The heater turns off when the water temperature is above 130 degrees F. or or time has expired for the wash cycle. The cycle time will **not** be extended to reach the desired temperature.

When the Sanitary Cycle is selected, the heater turns on if the water temperature in the tub is below 141 degrees F. The heater turns off when the water temperature is above 151 degrees F. The wash cycle will be extended to achieve the temperature of 151 degrees F.

# Component Testing Information

Note: The heater will not turn on more than once in a

wash cycle (no reheating).



**WARNING**

To avoid risk of electrical shock, personal injury or death, disconnect power to unit before servicing, unless testing requires power.

## Water flow through dispenser during Wash fill

WASH					
DRAIN	FILL / Rotation of Spinner	(HEATING)	WASHING	COOLING / DISENTANGLE	SUB TOTAL

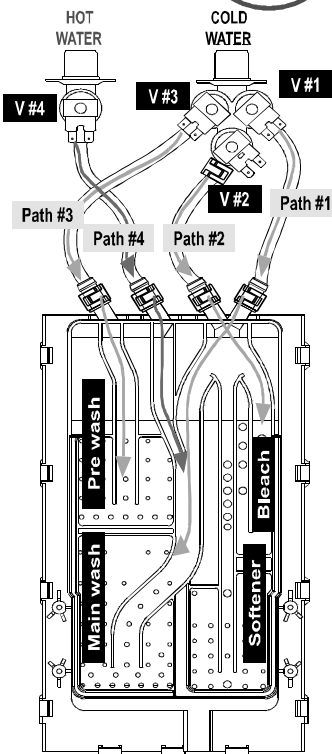

First minute of fill with no water in tub (*Reset Level – 25.6 kHz*).  
Valve #3 opens and cold water flows through path #3 to detergent compartment (Pre wash).

Specified Water Level (Final Water Level) for each cycle

1. If ATC (warm or cold) is selected,  
valves #1 and #4 open as needed to achieve specified water temperature. Cold water flows through path #1 and hot water through path #4 to the detergent compartment
2. If NON-ATC is applied,  
If "HOT wash" is selected, valve #4 opens and water flows through path #4.  
If "COLD wash" is selected, Valve #1 opens and cold water flows through path #1.

Cold wash and rinse, Non ATC: water temperature will be tap cold  
Cold wash, ATC: water temperature =  $65\text{ }^{\circ}\text{F} \pm 10^{\circ}\text{F}$   
Warm wash, ATC: water temperature =  $105\text{ }^{\circ}\text{F} \pm 10^{\circ}\text{F}$   
Warm Rinse, ATC: water temperature =  $80\text{ }^{\circ}\text{F} \pm 10^{\circ}\text{F}$   
for final rinse only, all other rinses will be "tap cold"  
Hot Wash, Non ATC: water temperature will be tap hot

# Component Testing Information



## WARNING

To avoid risk of electrical shock, personal injury or death, disconnect power to unit before servicing, unless testing requires power.

## Water flow through dispenser during Rinse 1 fill

RINSE 1					
DRAIN	MIDTERM SPIN	FILL / Rotation of Spinner	RINSE	DISENTANGLE / FILLING TO REMOVE SUDS	SUB TOTAL

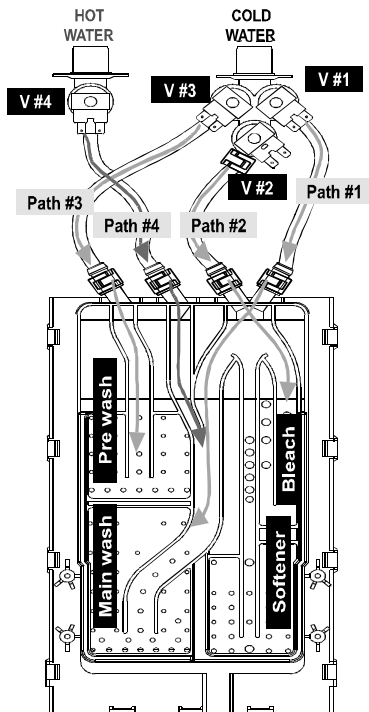

From NO water level (Reset Level) to the specified (final) water level.

Valves #2 and #3 open, and cold water flows through paths 2 and 3, to the detergent compartment.

In order to fill “Bleach”, Valve #2 opens and cold water flows through path #2 to the Bleach compartment.



# Component Testing Information



## WARNING

To avoid risk of electrical shock, personal injury or death, disconnect power to unit before servicing, unless testing requires power.

## Water flow through dispenser during Rinse 2 fill

RINSE 2					
DRAIN	MIDTERM SPIN	FILL / Rotation of Spinner	RINSE	DISENTANGLE / FILLING TO REMOVE SUDS	SUB TOTAL

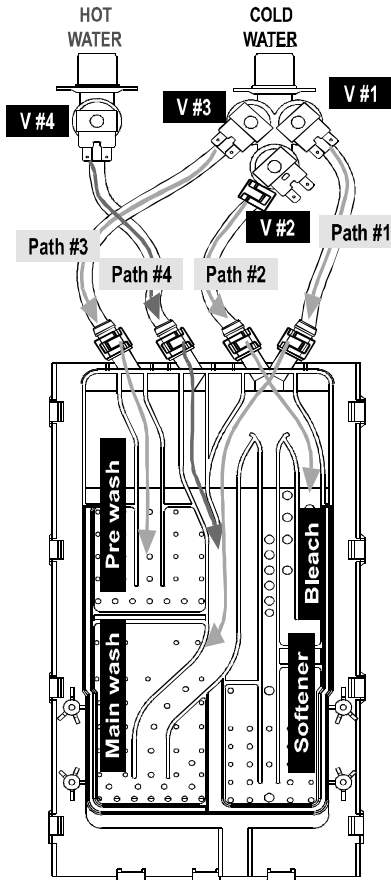

From no water level (Reset Level) to 1<sup>st</sup> sensing level (25.1kHz):

Valves #1 & #2 open at the same time. Cold water from valves #1 & #2 mix and fill Main wash/Softener/Bleach compartments.

Valve #1 & #2 are opened for 1<sup>st</sup> 9 seconds and closed for 15 seconds, After that, they are opened again to 1<sup>st</sup> sensing water level.

From 1<sup>st</sup> sensing level to specified water level for each cycle:

In order to meet the ATC temperature specification, the hot water valve & cold water valve #1 are opened as needed.

Finally, in order to remove the remaining water in the Bleach tray, Cold water valve #2 is opened for 8 seconds.

### 1<sup>st</sup> Water Sensing Level

- Wrinkle Control & Quick Wash – 24.9 kHz
- Others – 25.1 kHz

# Disassembly Procedures



**WARNING**

To avoid risk of electrical shock, personal injury or death; disconnect power to unit before servicing.

## Top Removal

1. Disconnect power supply to unit.
2. Remove 2 10mm screws from washer back.



3. Slide Top Cover towards the rear to clear the screw head from flange on the bottom side of the Top Cover.

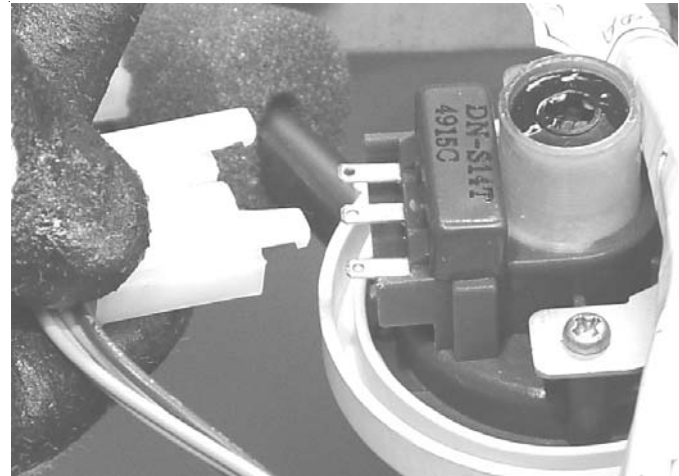
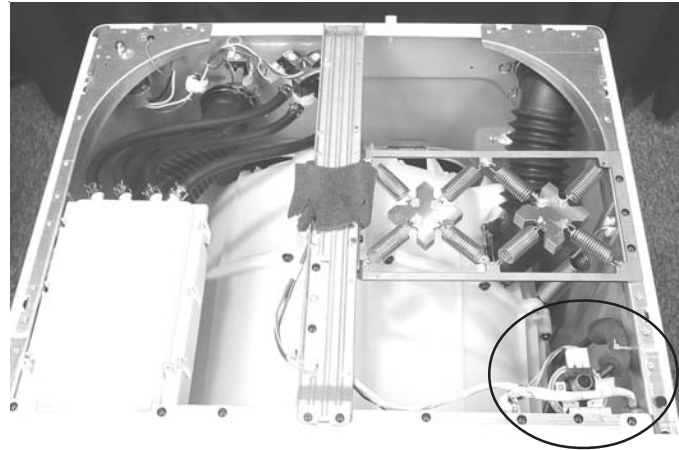

## Water Level Sensor Removal

1. Disconnect power supply to unit.
2. Remove Top Cover.
3. Remove harness plug.
4. Remove Pressure Hose.
5. Remove single attachment screw.

# Disassembly Procedures

 **WARNING**

To avoid risk of electrical shock, personal injury or death; disconnect power to unit before servicing.



**NOTE:** The reactor coil is wired in series with line 1 internally in the Control Board. An open coil or loose electrical connection would result in a “dead” board complaint. A resistance check across the coil leads should indicate less than 1 ohm.

## Reactor Removal

1. Disconnect power supply to unit.
2. Remove Top Cover.
3. Remove single attachment screw on cross brace.
4. Twist Reactor counterclockwise to remove.

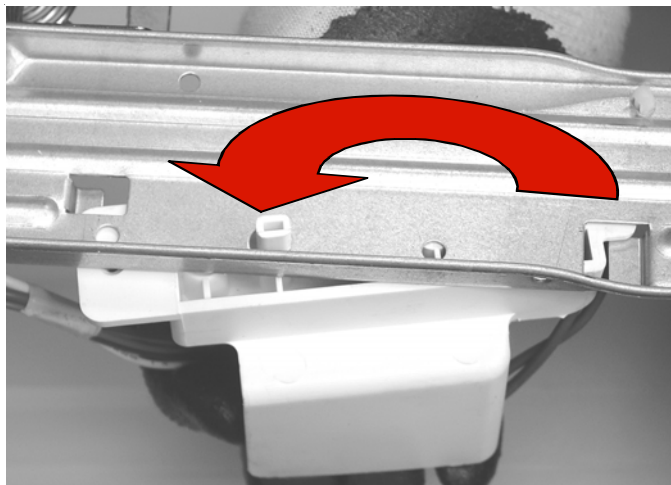

## EMI Filter Removal

1. Disconnect power supply to unit.
2. Remove Top Cover.
3. Loosen 13mm acorn nut and slide EMI Filter out of bracket.

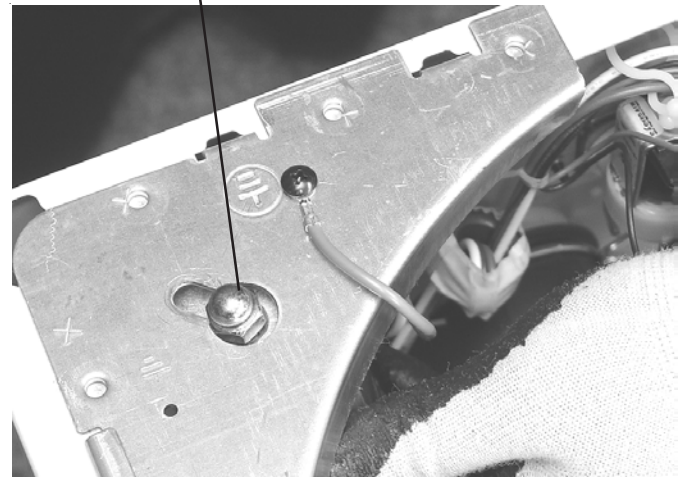
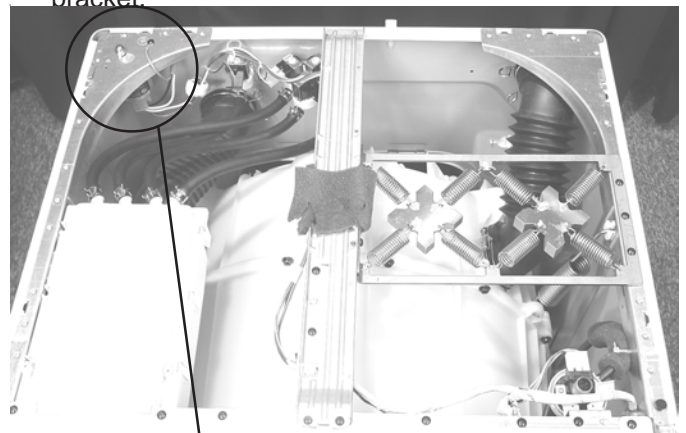

**NOTE:** Mark the wire locations on the EMI before removing the terminals.

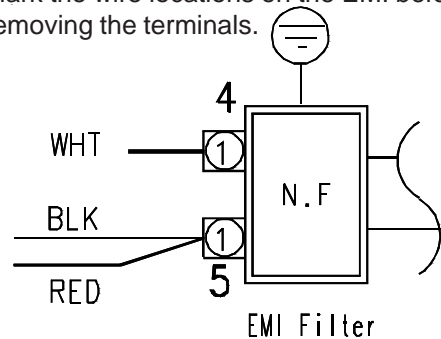

# Disassembly Procedures



**WARNING**

To avoid risk of electrical shock, personal injury or death; disconnect power to unit before servicing.

## Water Valve Removal

1. Disconnect power supply to unit.
2. Remove Top Cover.
3. Remove two screws each hot and 3 valve combo cold valve.



4. Remove hose clamps and hoses.



**NOTE:** The hose circuitry is marked on the Dispenser top.

## Dispenser Removal

1. Disconnect power supply to unit.
2. Depress the release tab and slide drawer from washer.

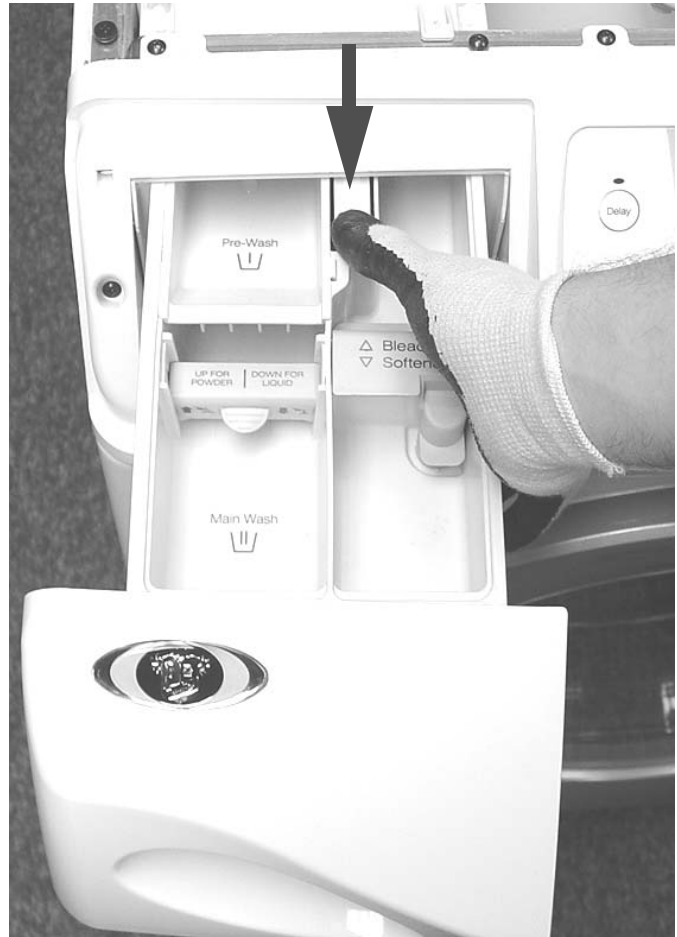

3. Remove Top Cover.
4. Remove clamps and hoses from dispenser.

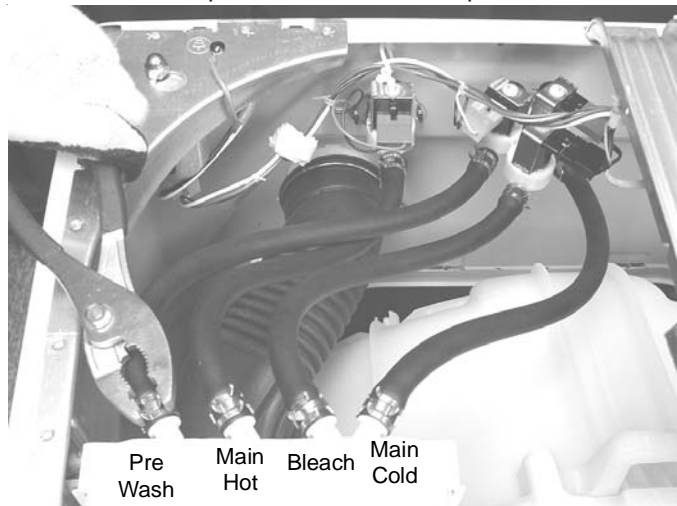

**NOTE:** The hose circuitry is marked on the Dispenser top.

5. Remove attachment screws and lift dipenser to expose fill hose.

# Disassembly Procedures

 **WARNING**

To avoid risk of electrical shock, personal injury or death; disconnect power to unit before servicing.

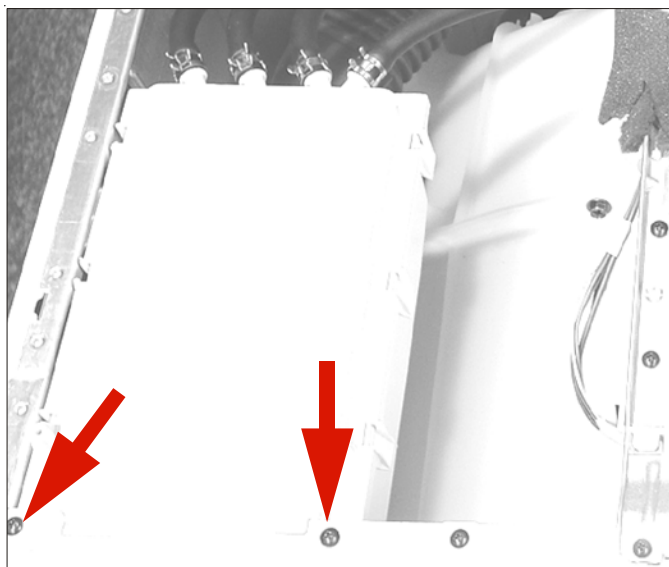

6. Remove fill hose clamp and hose.



## Console Removal

1. Disconnect power supply to unit.
2. Remove Top Cover.
3. Remove Dispenser Drawer.
4. Remove five screws attaching Console.



5. Roll Console down and lift away from washer.
6. Remove Reactor wire harness from wire clip.

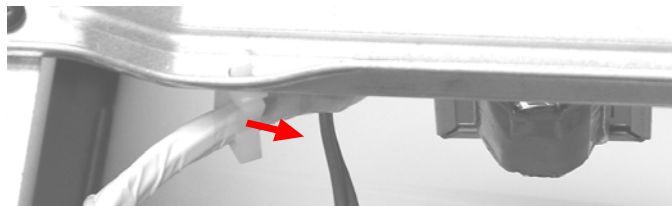

7. Remove Reactor wire harness connector from the PCB Board.
8. Remove five screws from PCB Housing to access the LED Circuit Board.

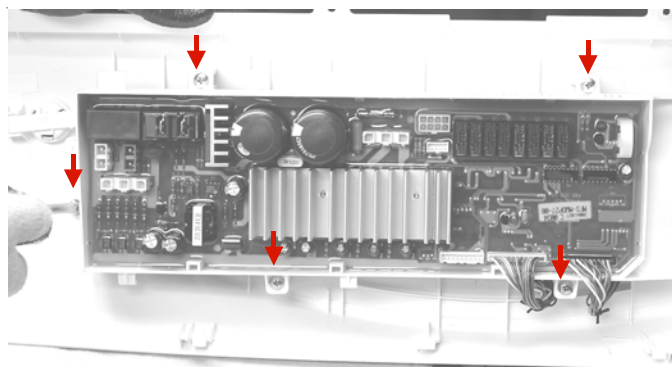

## Door Removal

1. Disconnect power supply to unit.
2. Remove four screws to remove door from Front Panel.

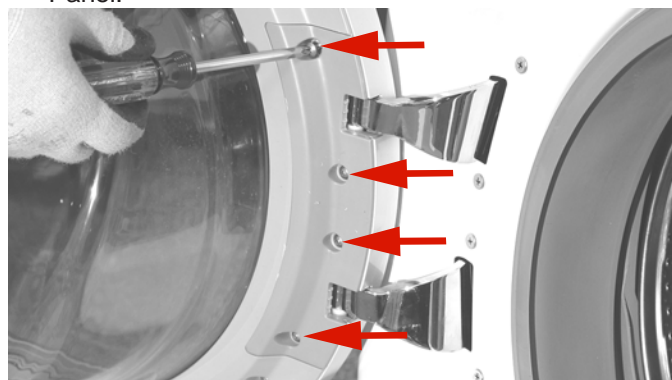

# Disassembly Procedures



To avoid risk of electrical shock, personal injury or death; disconnect power to unit before servicing.

3. Remove hinge retainer plate.

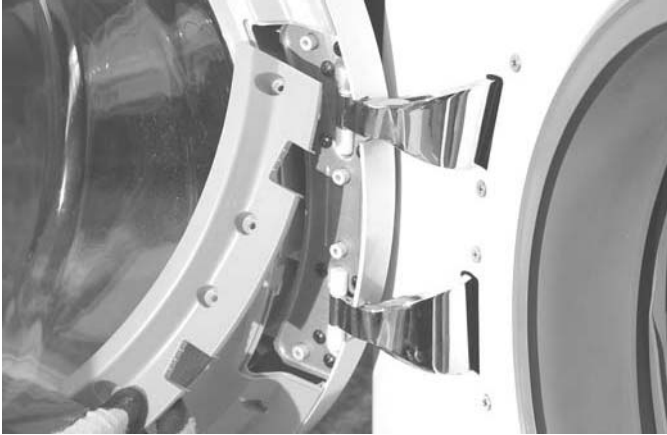

4. Remove door from hinge posts.



5. Remove Screws around the perimeter of the glass retainer.



6. Remove the glass retainer.



7. Remove glass.



8. Remove external viewing window.



# Disassembly Procedures



## WARNING

To avoid risk of electrical shock, personal injury or death; disconnect power to unit before servicing.

### Front Panel Removal

1. Disconnect power supply to unit.
2. Remove Top Cover.
3. Remove Console.
4. Open door and remove Boot Retainer Clamp. Expand the Boot Clamp Spring located at the 6 o'clock position.



5. Pull the boot from the lip formed into the front opening.

6. Remove four screws attaching the front to the cabinet.



7. Disconnect the wire connectors to the Door Lock.



# Disassembly Procedures

## **WARNING**

To avoid risk of electrical shock, personal injury or death; disconnect power to unit before servicing.

8. Lift Front Panel from bottom brackets.



**NOTE:** When installing the boot align the index tabs on the boot with the screws on either side of the Fill Tube.

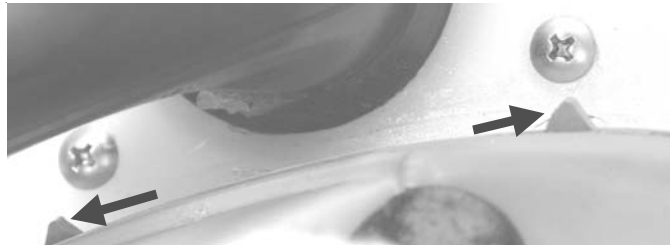

### Heater Removal

1. Disconnect power supply to unit.
2. Remove Top Cover.
3. Remove Console.
4. Remove Front Panel.
5. Remove Thermistor and Heater wiring connectors.

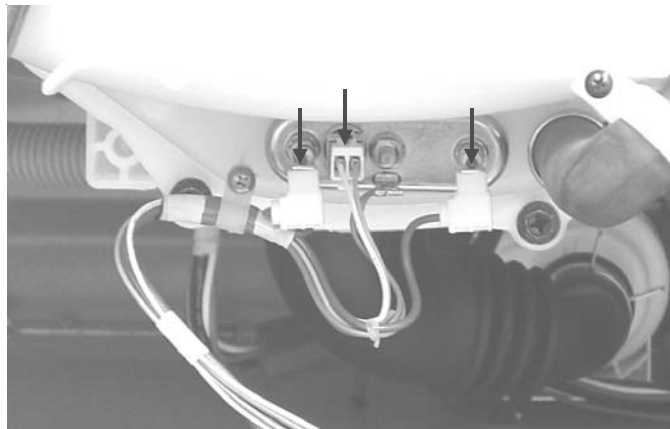

### Boot Removal

1. Disconnect power supply to unit.
2. Remove Top Cover.
3. Remove Console.
4. Remove Front Panel.
5. Loosen boot clamp at the 12 o'clock position.

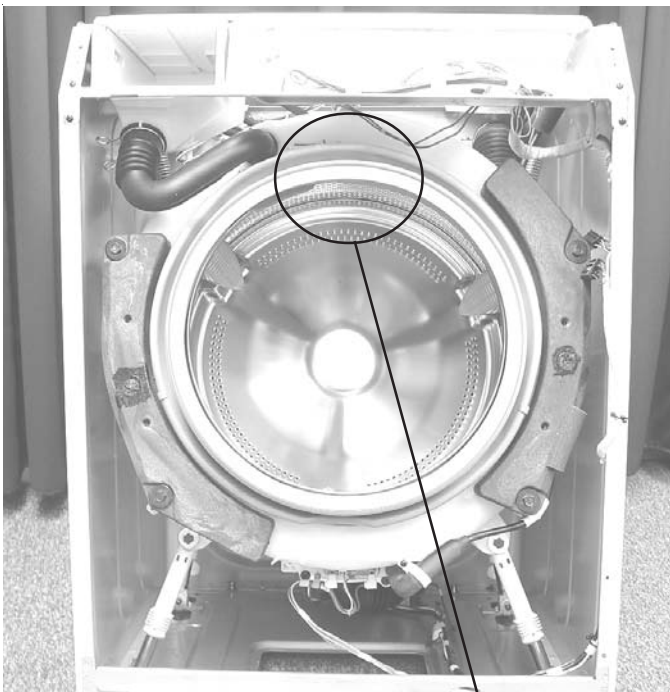

6. Loosen 10mm nut on Heater and remove Heater Element.



**NOTE:** Install Heater Element on top of metal bracket.





# Disassembly Procedures



**WARNING**

To avoid risk of electrical shock, personal injury or death; disconnect power to unit before servicing.

## Motor Removal

1. Disconnect power supply to unit.
2. Remove two screws attaching Back Cover and slide cover up and lift bottom edge out of retaining slots.

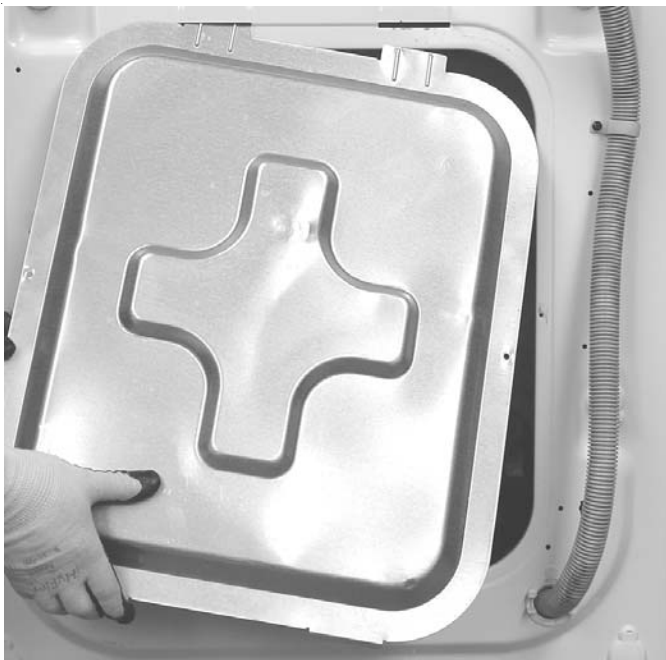
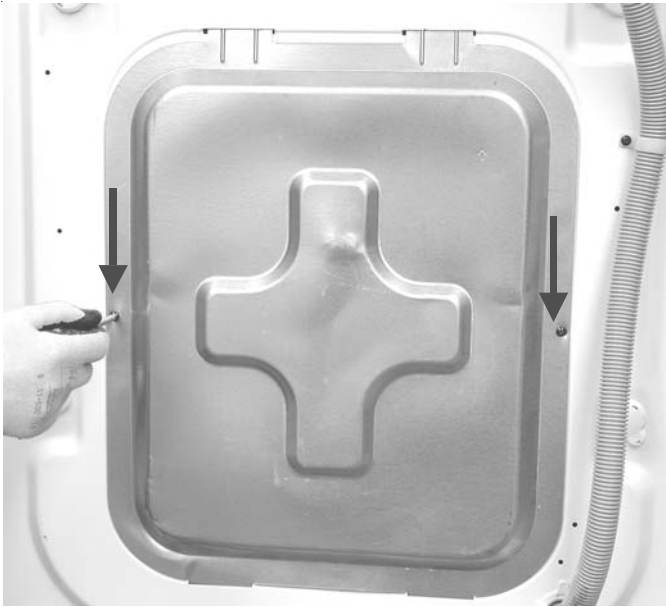

3. Remove either vent tube from the outer Tub.



4. Rotate the Spinner to locate a slot. Insert a rubber handled tool or equivalent object to lock the Spinner while removing the Motor nut.



# Disassembly Procedures

## **WARNING**

To avoid risk of electrical shock, personal injury or death; disconnect power to unit before servicing.

5. Remove 19mm nut .



**NOTE:** When reinstalling Motor torque nut to 32-47 ft. lbs.

6. Grasp the Rotor at 3 and 9 o'clock while pulling Rotor from shaft.

**CAUTION:** The rotor contains powerful magnets. Use caution during handling and installation. **DO NOT** place fingers between rotor and windings during installation.

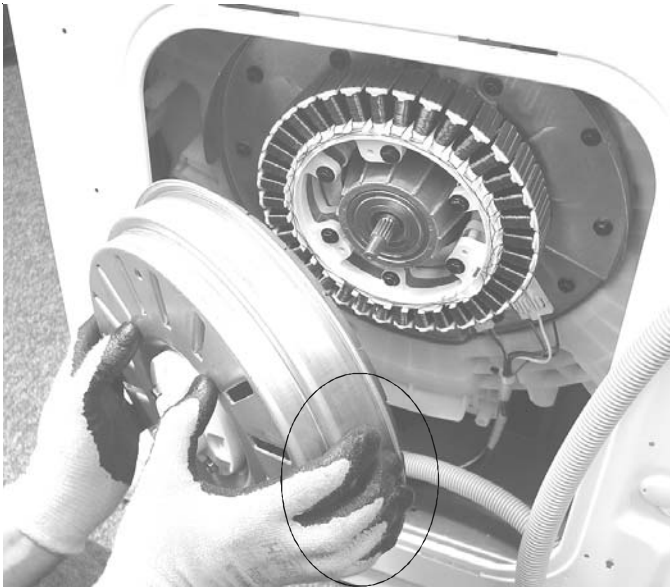

7. Depress and release latch to remove motor wiring connectors.

7. Depress and release latch to remove motor wiring connectors.

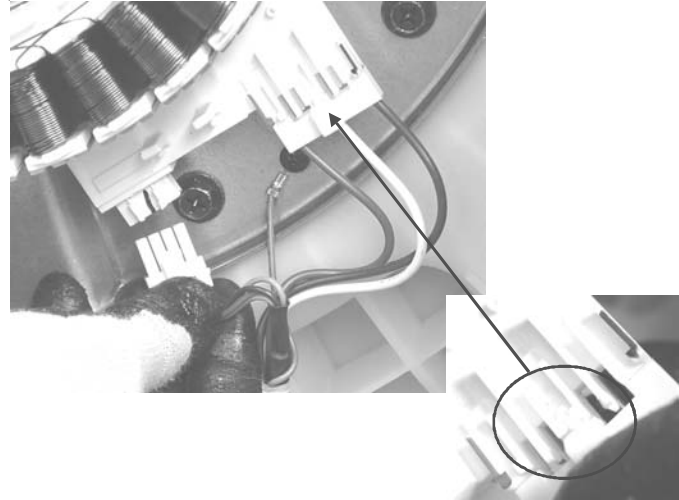

8. Remove the six 10mm bolts securing stator coil to the tub.

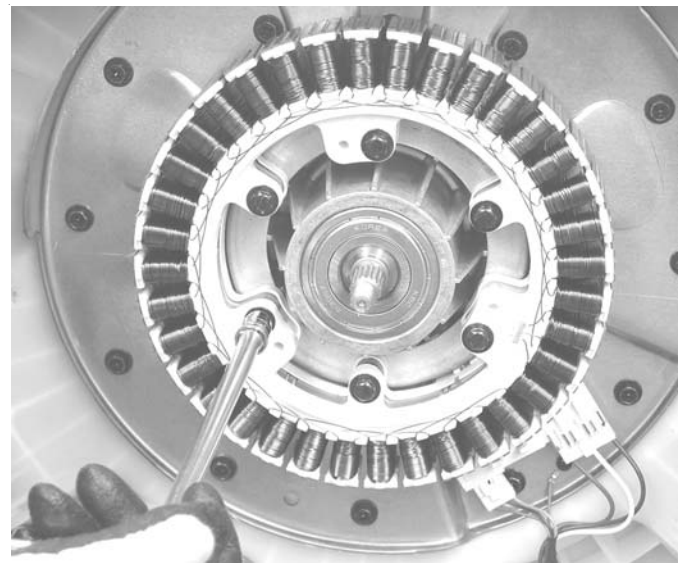

**NOTE:** There are alignment pins for the Stator reinstallation. Use caution during removal and installation, the stator will not hang from the alignment pins. Start a screw while supporting the Stator with the other hand.

# Disassembly Procedures

 **WARNING**

To avoid risk of electrical shock, personal injury or death; disconnect power to unit before servicing.

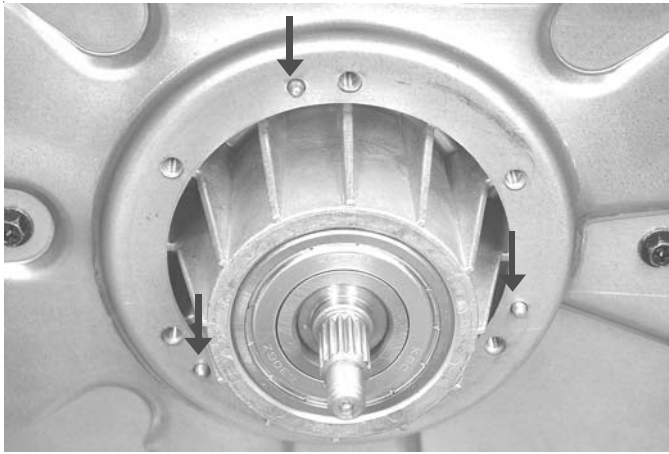

## Drain Pump Removal

1. Disconnect power supply to unit.
2. Remove Back Cover.
3. Remove clamp and Drain Hose.
4. Remove clamp and Pump Hose.



5. Remove wiring connector.

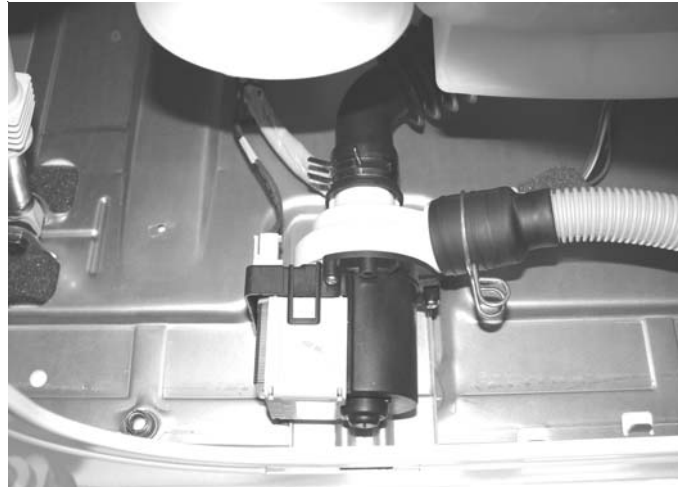

6. Remove three 13mm bolts securing Drain Pump to base.



7. Remove screw securing Drain Pump to bracket. Twist Drain Pump clockwise to remove.

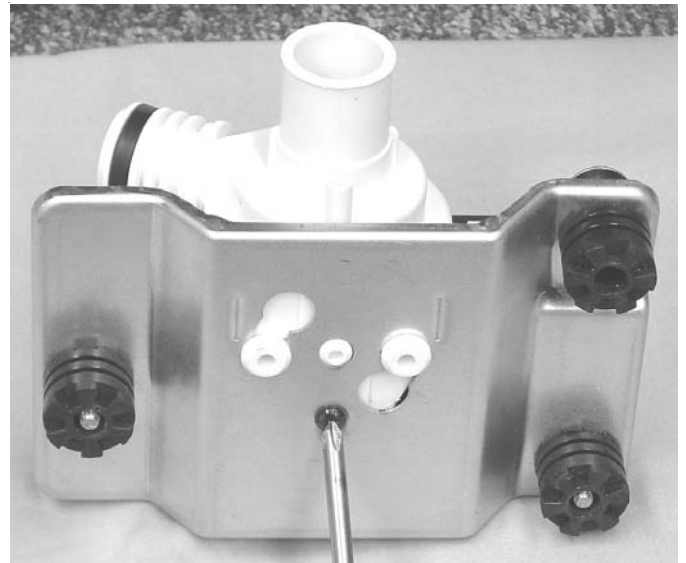

# Disassembly Procedures

## **WARNING**

To avoid risk of electrical shock, personal injury or death; disconnect power to unit before servicing.

### Outer Tub and Spinner Removal

1. Disconnect power supply to unit.
2. Remove Top Cover.
3. Remove Console.
4. Remove Front Panel.
5. Remove Back Cover.
6. Remove Pump Hose.
7. Remove the Drain Hose
8. Remove the two 13mm bolts securing the Rear Struts to the base.

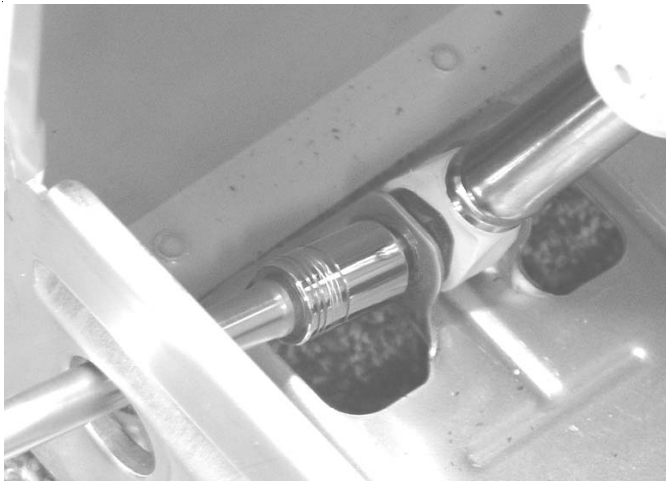

**NOTE:** Torque bolts to 11-22 ft lbs. during installtion.

11. Remove wire harness connectors for the heater, Themistor and ground.
12. Remove two 13mm bolts securing the Front Struts to base and rotate up against the bottom of the tub.
13. Insert a board or boards across the bottom of the washer frame to use as a support when removing the tub assembly.

9. Rotate the struts up against the bottom of the tub to ease removal of the tub assembly.

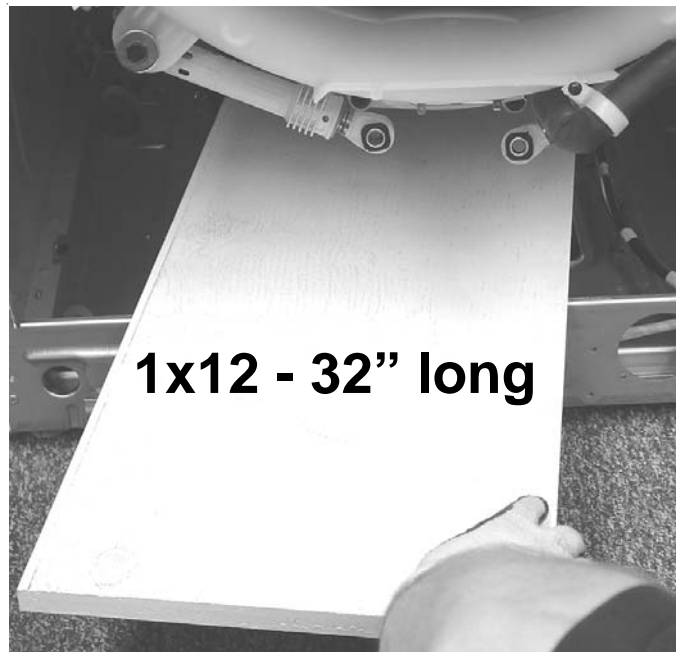
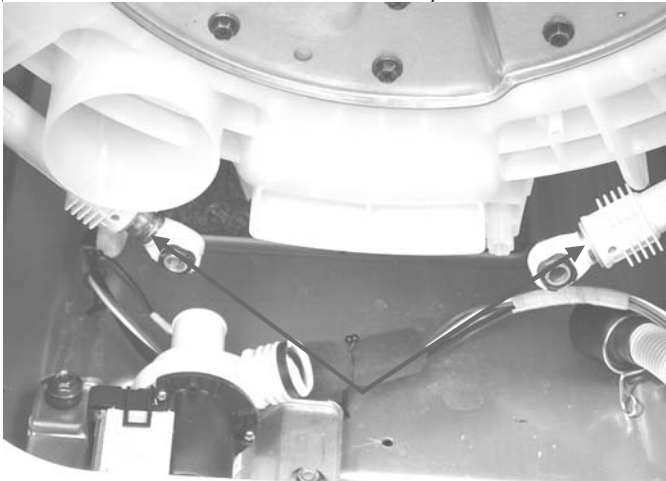

**1x12 - 32" long**

**NOTE:** The rear struts can be identified by the green sleeve.

10. Remove two each side 13mm bolts securing Counter Weights.

# Disassembly Procedures

 **WARNING**

To avoid risk of electrical shock, personal injury or death; disconnect power to unit before servicing.



14. Remove fill hose.

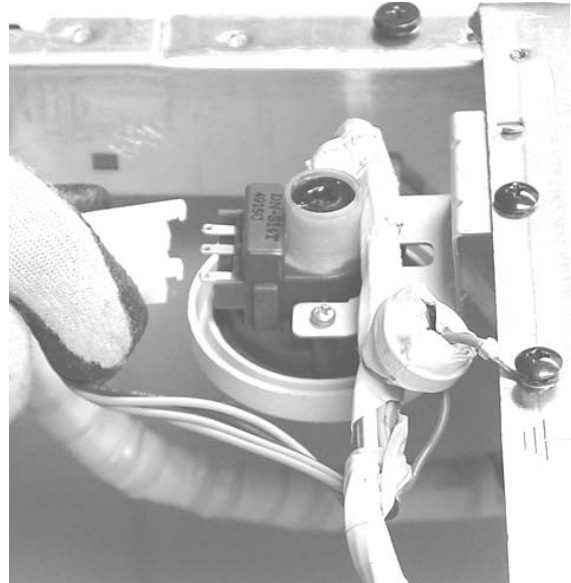

16. Remove the Pressure Hose.



15. Remove Pressure Switch harness connector.



17. Remove ground wire.



## Disassembly Procedures



To avoid risk of electrical shock, personal injury or death; disconnect power to unit before servicing.

18. Remove left and right Vent Hoses.

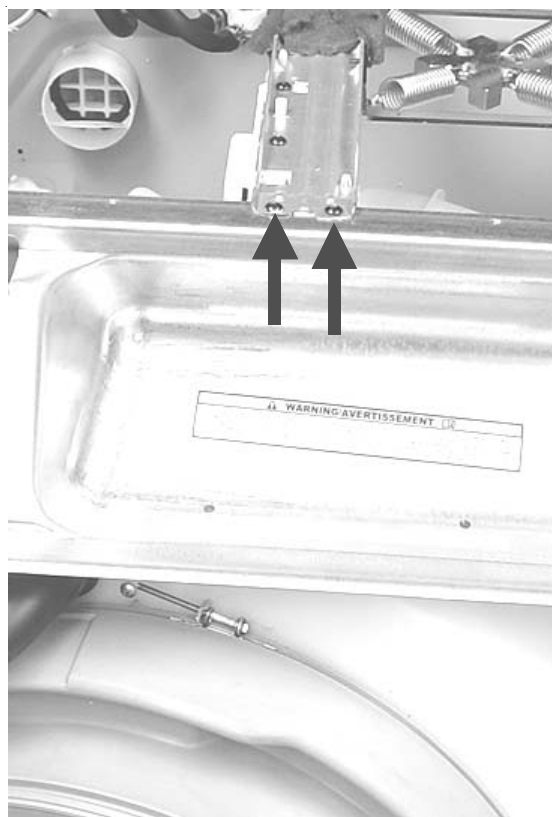

19. Lift Suspension Spring from keeper in cabinet.  
Repeat for the opposite side and let Outer Tub rest on support board.



21. Remove remaining screws securing Back Guard to cabinet.



20. Remove two screws securing Center Brace to Back Guard.

22. Grasp the front and rear of the tub and slide out. Use a blanket or rug to protect the floor

## Disassembly Procedures



**WARNING**

To avoid risk of electrical shock, personal injury or death; disconnect power to unit before servicing.



23. Set the tub on the floor. Position 4" wood blocks or equivalent around the spinner shaft. Roll the tub to the upright position and rest it on the blocks.

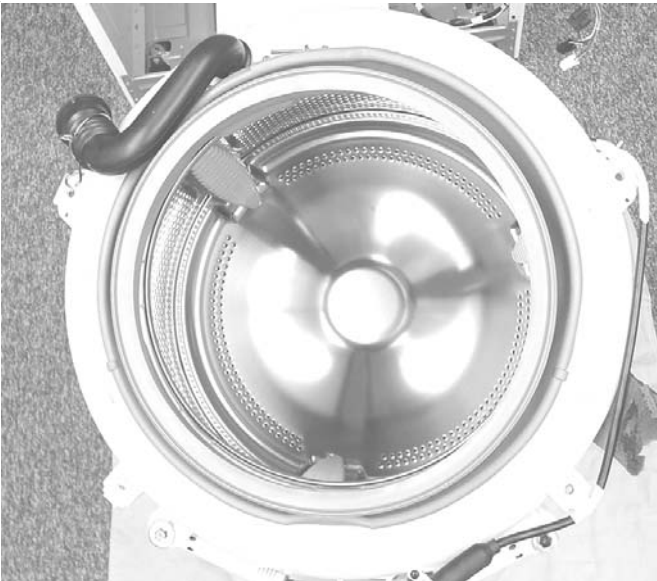

24. Remove the 10mm screws around the perimeter of the tub.



**NOTE:** Torque tub bolts to 6-11 ft. lbs.

25. Separate the front and rear halves of the Outer Tub.



26. Tub Gasket can be replaced after tub halves are split.

## Disassembly Procedures

 **WARNING**

To avoid risk of electrical shock, personal injury or death; disconnect power to unit before servicing.

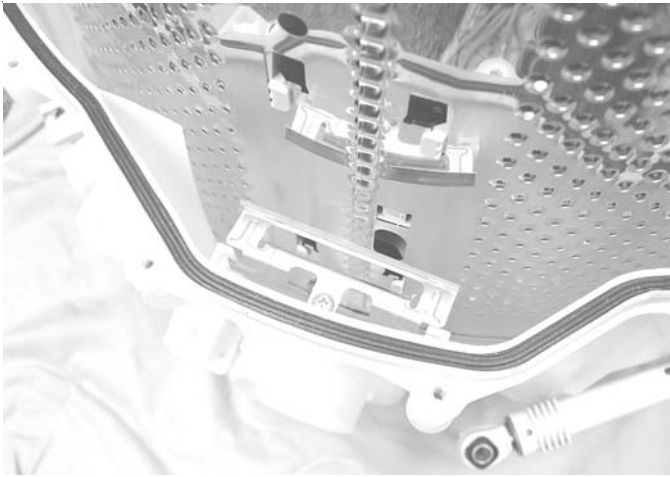

27. Lift Spinner to access Wave Washer.

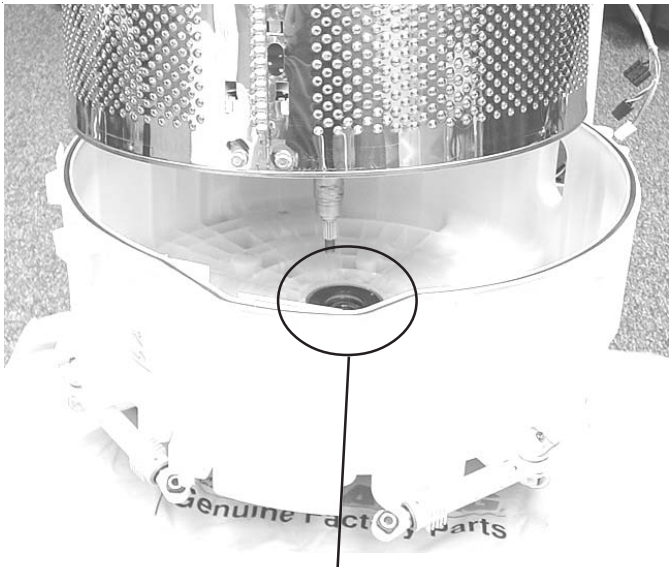

28. Remove screw and release tab to remove Baffles

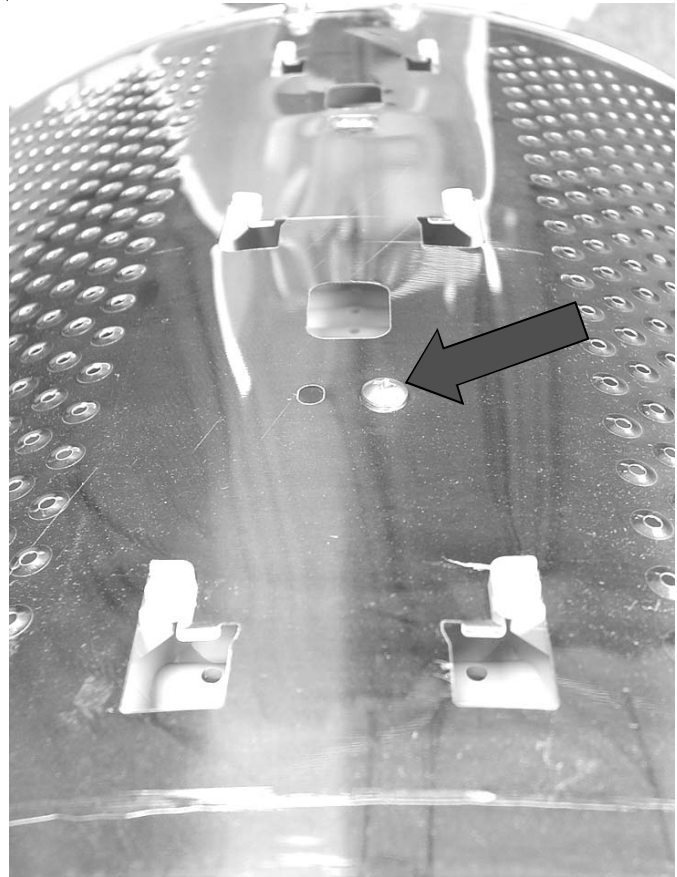



# Appendix A

# HIGH-EFFICIENCY WASHER INSTALLATION INSTRUCTIONS

MACHINE À LAVER HAUTE EFFICACITÉ  
GUIDE DE MISE EN SERVICE

INSTRUCCIONES PARA LA INSTALACIÓN  
DE LA LAVADORA DE ALTA EFICIENCIA

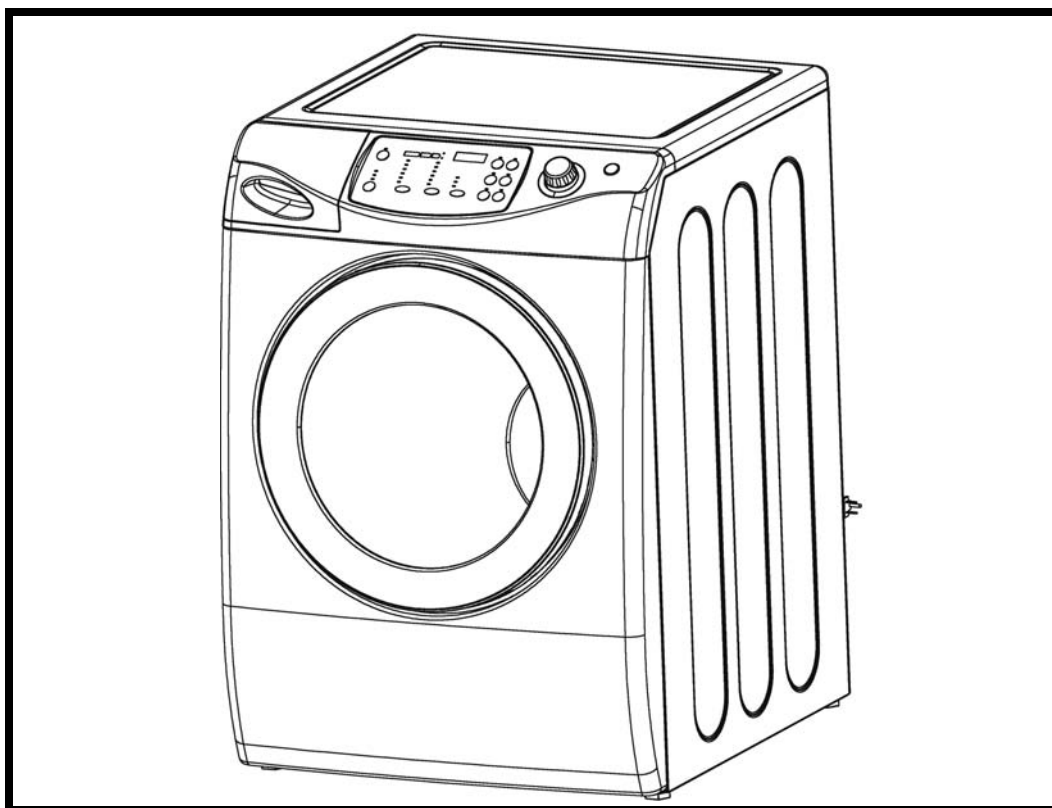

LEAVE THESE INSTRUCTIONS WITH THE OWNER

LAISSER CE GUIDE DE MISE EN SERVICE AU PROPRIÉTAIRE

DEJAR ESTAS INSTRUCCIONES CON EL PROPIETARIO

DC68-02032B  
101504

# READ THIS BEFORE YOU START ...

Tools needed for installation:

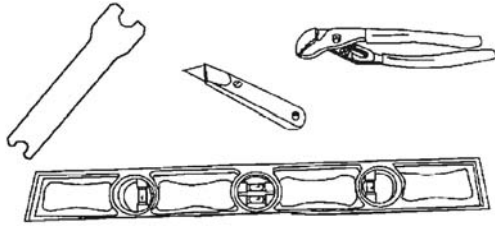

- Multi wrench
- Utility knife
- Channel lock
- Level

PARTS supplied for installation:

Cable tie to secure drain hose to standpipe, inlet hose or laundry tub



**Bolt hole covers**



**Hose guide**



**Wrench**

## ELECTRICAL

Refer to serial plate for specific electrical requirements. For more detailed information refer to section on Electrical Requirements.

## WATER

Washer needs two standard 3/4 inch water supply faucets with a pressure between 20–120 pounds per square inch. For more detailed information refer to section on Water Requirements.

## CABINET DIMENSIONS

WASHER DIMENSIONS		INCH (CM)
A.	Height-Overall	38" (96.5)
B.	Width	27" (68.6)
C.	Depth-With Washer Door Open 90 Degrees	50-7/8" (129.2)
D.	Depth	30-3/4" (78.1)

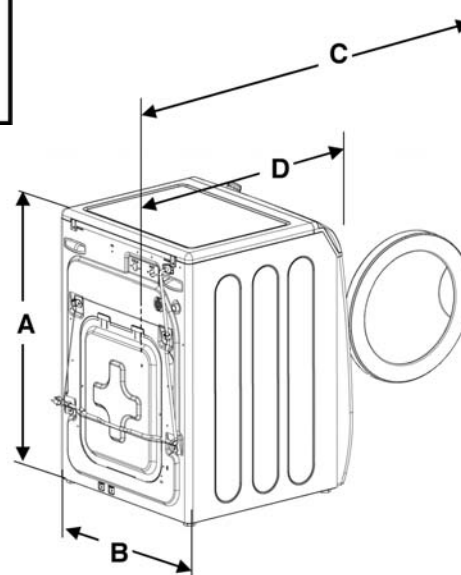

Note:

The height of the washer from top to floor is 38" this includes the leveling leg screwed all the way in. The customer can unscrew the leg out an additional 7\8" for a total overall height of 38 7\8".

# BASIC LOCATION REQUIREMENTS :

## ELECTRICAL

- 120 Volt 60 Hz 15 AMP Fuse or Circuit Breaker
- Individual branch circuit serving only the washer is recommended.
- The washer is equipped with a power cord.  
NEVER USE AN EXTENSION CORD.

## GROUNDING

ELECTRICAL GROUND IS REQUIRED ON THIS APPLIANCE.

Appliance is equipped with a power cord having a 3-prong grounding plug for use in a properly installed and grounded outlet.



- Improper connection of the equipment-grounding conductor can result in a risk of electrical shock. Check with a qualified electrician or serviceman if you are in doubt as to whether the appliance is properly grounded. Do not modify the plug provided with the appliance – if it will not fit the outlet, have a proper outlet installed by a qualified electrician.

### IMPORTANT SAFETY PRECAUTIONS

- To prevent unnecessary risk of fire, electrical shock or personal injury, all wiring and grounding must be done in accordance with the National Electrical Code ANSI/FNPA, No. 70-Latest Revision and local codes and ordinances. It is the personal responsibility and obligation of the appliance owner to provide adequate electrical service for this appliance.

## ADDITIONAL GROUNDING CONNECTIONS

A grounding kit (Part No. 12001875) is available. It contains the ground wire, clamp, ground screw and washer. Connect the ground wire to back of unit with the cabinet ground screw and washer. Secure the other end of ground wire to a grounded COLD metal water pipe.

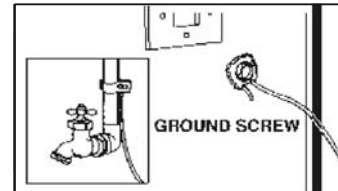

NEVER CONNECT GROUND WIRE TO PLASTIC PLUMBING LINES, GAS LINES OR HOT WATER PIPES.

## WATER

To correctly fill the washer in the proper amount of time, Water pressure of 20 to 120 p.s.i. is required. Water pressure less than 20 psi may cause a failure in the water valve and may not allow the water valve to shut off completely. Or may extend the fill time beyond what the washer controls will normally allow and result in the washer turning off. A time limit is built into the controls in the event of an internal hose becoming loose and avoids a flooded home.

The water valve Hot and Cold water faucets must be within 4 feet of the back of the washer for inlet hoses provided with the washer. NOTE: Accessory inlet hoses are available in various lengths up to 10 feet for faucets more than 4 feet from the back of the washer.

#### To Avoid The Possibility Of Water Damage:

- Have Water Faucets Easily Accessible
- Turn Off Faucets When Washer Is Not In Use.

## DRAIN FACILITY

Recommended height of the standpipe is 18". The drain hose must be routed through the drain hose clip to the standpipe. Standpipe must be large enough to accept the outside diameter of the drain hose. The drain hose is attached at the factory.

## FLOORING

For best performance the washer must be installed on a solidly constructed floor. Wood floors may need to be reinforced to minimize vibration and/or unbalanced load situations. Carpeting and soft tile surfaces are contributing factors in vibration and/or tendency for a washer to move slightly during the spin cycle. Never install the washer on a platform or weakly supported structure.

## LOCATION CONSIDERATIONS

It is recommended the washer never be installed in areas where water may freeze since the washer will always maintain some water in the water valve, pump and hose areas. This can cause damage to belts, pump, hoses and other components. Operating temperature should be above 60°F.

## ALCOVE OR CLOSET INSTALLATION

MINIMUM CLEARANCES FOR CLOSET AND ALCOVE INSTALLATIONS:

Sides – 0 in / 0 mm    Rear – 0 in / 0 mm

Top – 0 in / 0 mm    Closet Front – 0 in / 0 mm

The closet front must have a total unobstructed air opening of 72 in<sup>2</sup> / 465 cm<sup>2</sup> minimum, if both washer and dryer are installed together. A louvered door with equivalent air opening is acceptable. Washer alone does not require specific air opening.

## ADDITIONAL INFORMATION

### 50-HERTZ OPERATION

This Maytag appliance is manufactured for operation on 60 Hz AC approved electrical service. This model is not designed for use on 50 Hz AC electrical services and conversion of the product from 60 to 50 Hz operations is not recommended. For additional information on 50 Hz products, write:

MAYTAG INTERNATIONAL, INC.  
1475 East Woodfield Road  
Schaumburg, Illinois 60173  
Phone: 847-273-3100

### FOR TECHNICAL ASSISTANCE, REPLACEMENT PARTS AND ACCESSORIES

For technical assistance or if your washer requires replacement parts or accessories, contact Maytag Customer Service, toll-free 1-888-4-Maytag for information on the nearest authorized Maytag Parts Distributor.

Proper installation is the responsibility of the owner; Service Calls Performed As A Result Of Improper Set-up, Adjustment And/Or Connection Are The Responsibility Of The Installer.

## UNPACKING THE WASHING MACHINE

Unpack your washing machine and inspect it for shipping damage and have you have received all of the items shown on page 2. If the washing machine was damaged during shipping or you do not have all of the items, contact your Maytag dealer immediately.

# IMPORTANT TO INSTALLER

Please Read The Following Instructions Carefully Before Installing The Washing Machine.

These Instructions Should Be Retained For Future Reference.

Remove The Door From All Discarded Appliances To Avoid The Danger Of A Child Suffocating.

## STEP 1

### PREPARE WASHER

#### Removing The Shipping Bolts

Before using the washing machine, you must remove the four shipping bolts from the back of the unit.

1. Loosen all bolts with the supplied wrench before removing them.
2. Slide the bolt and spacer up and remove the bolt with spacer through the hole in the rear wall of the washer. Repeat for each bolt.
3. Fill the holes with the supplied plastic covers.
4. Keep the shipping bolts and spacers for future use.

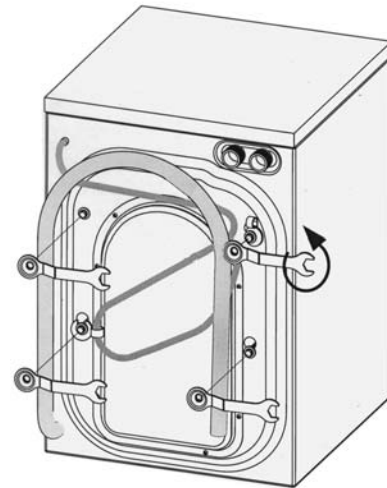

## STEP 2

### INSTALLING THE WASHING MACHINE

#### Selecting a location

Before you install the washing machine, select a location with the following characteristics:

- A hard, level surface (if the surface is uneven, see "Adjusting the leveling feet," below)
- Locate away from direct sunlight.
- Adequate ventilation
- Room temperature that will not fall below 32°F or 0°C.
- Away from sources of heat such as coal or gas
- Make sure that the washing machine does not stand on its power cord.
- Carpeting must not obstruct ventilation openings when the washing machine is installed on a carpeted floor.

NOTE: Keep the leg extension at a minimum to prevent excessive vibration. The farther out the legs are extended the more the washer will vibrate and possibly walk.

## FINAL INSTALLATION CHECKLIST

- o Instruction and Installation Kit have been removed from tub.
- o Shipping bolts and spacers have been removed.
- o Washer is plugged into electrical outlet and is properly grounded.
- o Water hoses are connected to the faucets with inlet screens and washers.
- o Water is turned on and checked for leaks at faucet and water valve connections on back of washer.
- o Drain hose is properly located into drain facility and is not collapsed or damaged.
- o Washer has been properly leveled. All legs should be firmly on the floor and leveling leg lock nuts tightened up against the bottom of the washer base frame.
- o Washer fills properly on all temperature selections.
- o Test for proper operation by running the washer through a complete cycle.

## COLD WEATHER STORAGE

The following precautions should be taken if a washer is to be stored, after use, where it would be subject to freezing conditions.

1. Turn off the water supply, then remove the inlet hoses from the faucets.
2. Place the end of the inlet hoses into a bucket or container. Select a fill cycle and energize the water valve by selecting a warm water setting. A few seconds of fill is sufficient to empty the inlet hoses.
3. Disconnect from electrical supply.
4. Lower the drain hose to floor level and tilt washer backwards to remove water from the drain hose and pump.



# Appendix B



# MAYTAG NEPTUNE<sup>®</sup> WASHER

# USE & CARE

## G U I D E

### TABLE OF CONTENTS

Safety Instructions .....	1-2
Operating Instructions .....	3
Using the Controls .....	4-8
Water Use .....	8
Detergent Use .....	9
Features .....	9-10
Care and Cleaning .....	11
Storing the Washer .....	12
Troubleshooting .....	12-14
Warranty .....	15
Guide d'utilisation et d'entretien .....	16
Guía de Uso y Cuidado .....	32

## WELCOME

Welcome and congratulations on your purchase of a Maytag Neptune® washer! Your complete satisfaction is very important to us. For best results, we suggest reading this material to help acquaint you with proper operating and maintenance procedures.

Should you need assistance in the future, it is helpful to:

- 1) Have complete model and serial number identification of your washer.

Date of Purchase \_\_\_\_\_

Model Number \_\_\_\_\_

Serial Number \_\_\_\_\_

- 2) **IMPORTANT: Keep this guide and the sales receipt in a safe place for future reference. Proof of original purchase date is needed for warranty service.**

If you have questions, call:

Maytag Customer Assistance  
1-800-688-9900 USA  
1-800-688-2002 CANADA  
(Mon.–Fri., 8am–8pm Eastern Time)  
Internet: <http://www.maytag.com>

U.S.A. customers using TTY for deaf, hearing impaired or speech impaired, call 1-800-688-2080.

**NOTE: In our continuing effort to improve the quality of our appliances, it may be necessary to make changes to the appliance without revising this guide.**

**For service and warranty information, see page 15.**

## IMPORTANT SAFETY INSTRUCTIONS

read before operating your washer

### WHAT YOU NEED TO KNOW ABOUT SAFETY INSTRUCTIONS

Warning and Important Safety Instructions appearing in this manual are not meant to cover all possible conditions and situations that may occur. Common sense, caution, and care must be exercised when installing, maintaining or operating appliance.

Always contact your manufacturer about problems or conditions you do not understand.

### RECOGNIZE SAFETY SYMBOLS, WORDS, LABELS

#### **WARNING**

**WARNING** – Hazards or unsafe practices which **COULD** result in severe personal injury or death.

#### **CAUTION**

**CAUTION** – Hazards or unsafe practices which **COULD** result in minor personal injury or property damage.

## SAVE THESE INSTRUCTIONS

## IMPORTANT SAFETY INSTRUCTIONS

### WARNING

To reduce the risk of fire, electric shock or injury to persons when using the appliance, follow basic precautions, including the following:

1. Read all instructions before using the appliance.
2. As with any equipment using electricity and having moving parts, there are potential hazards. To use this appliance safely, the operator should become familiar with the instructions for operation of the appliance and always exercise care when using it.
3. Do not install or store this appliance where it will be exposed to the weather.
4. Install and level the clothes washer on a floor that can support the weight.
5. This appliance must be properly grounded. Never plug the appliance cord into a receptacle which is not grounded adequately and in accordance with local and national codes. See installation instructions for grounding this appliance.
6. To avoid the possibility of fire or explosion:
  - Do not wash items that have been previously cleaned in, washed in, soaked in, or spotted with gasoline, dry-cleaning solvents, or other flammable or explosive substances as they give off vapors that could ignite or explode. Hand wash and line dry any items containing these substances.

Any material on which you have used a cleaning solvent, or which is saturated with flammable liquids or solids, should not be placed in the clothes washer until all traces of these liquids or solids and their fumes have been removed.

These items include acetone, denatured alcohol, gasoline, kerosene, some liquid household cleaners, some spot removers, turpentine, waxes and wax removers.
  - Do not add gasoline, dry-cleaning solvents, or other flammable or explosive substances to the wash water. These substances give off vapors that could ignite or explode.
  - Under certain conditions, hydrogen gas may be produced in a hot water system that has not been used for 2 weeks or more. **HYDROGEN GAS IS EXPLOSIVE.** If the hot water system has not been used for such a period, before using a washing machine or combination washer-dryer, turn on all hot water faucets and let the water flow from each for several minutes. This will release any accumulated hydrogen gas. As the gas is flammable, do not smoke or use an open flame during this time.
7. Unplug power supply cord before attempting to service your clothes washer.
8. Do not reach into the appliance if the tumbler is moving.
9. Do not allow children to play on or in the appliance. Close supervision of children is necessary when the appliance is used near children.
10. Do not tamper with controls.
11. Do not repair or replace any part of the appliance or attempt any servicing unless specifically recommended in published user-repair instructions that you understand and have the skills to carry out.
12. Store laundry aids and other material in a cool, dry place where children cannot reach them.
13. Do not wash or dry items that are soiled with vegetable or cooking oil. These items may contain some oil after laundering. Due to the remaining oil, the fabric may smoke or catch fire by itself.
14. Do not use chlorine bleach and ammonia or acids (such as vinegar or rust remover) in the same wash. Hazardous fumes can form.
15. Do not machine wash fiberglass materials. Small particles can stick to fabrics washed in following loads and cause skin irritation.
16. Before the appliance is removed from service or discarded, remove the door to the washing compartment.
17. Do not sit on top of the clothes washer.
18. Inlet hoses are subject to damage and deterioration over time. Check the hoses periodically for bulges, kinks, cuts, wear or leaks and replace them every five years.

## OPERATING INSTRUCTIONS

For detailed information on sorting, pretreating stains, etc., see the enclosed **Laundering Tips** booklet.

### LOAD THE CLOTHES WASHER

- The tub can be loaded completely full with dry, unfolded clothes. However, **DO NOT** pack the tub tightly.
- Overloading may reduce washing efficiency, cause excess wear and possibly cause creasing or wrinkling of the load.
- Wash delicate items such as bras, hosiery and other lingerie in the Delicates or Hand Wash (select models) cycle with similar lightweight items.
- When washing big bulky items or a couple of small items that do not fill the tub completely, such as a rug, a few towels should be added for improved tumbling and spin performance.
- When washing smaller, bulky items that do not fill the tub completely such as a rug, one pillow, stuffed toys or one or two sweaters, a few towels should be added for improved tumbling and spin performance.
- When washing heavily soiled loads, it is very important to avoid overloading the washer to assure good cleaning results.
- To add a forgotten item in the Super Wash, Normal, Whites (select models), Colors (select models), Wrinkle Control or Quick Wash cycles, press the **Cycle Selector** dial, wait for the Door Lock light to go out (5 seconds), add the item, close the door and press the **Cycle Selector** dial. After a pause of one to two minutes, the cycle will resume.
- Close door carefully to avoid slamming.

**NOTE:** To ensure that your additional items get clean, do not wait more than five minutes after the cycle has started to add the item.

### GETTING STARTED

1. Load the washer loosely – **DO NOT** overload.
2. Close the door.
3. Add detergent and additives to the dispenser (see pages 9-10).
4. Select the appropriate cycle and options for the load, (see pages 4-7).
5. Press the **Cycle Selector** dial.
6. The Wash Indicator light will illuminate.
7. The estimated cycle time will appear in the display. The time may fluctuate to better indicate the wash time remaining in the cycle.
8. Before the washer starts to fill, it will make a series of clicking noises to check the door lock and do a quick drain.

#### NOTES:

- When the cycle is complete, the Door Lock light will go out and "End" or "00" (select models) will appear in the display.
- **DO NOT** attempt to open the door until the Door Lock light is off. To add a forgotten item, see "Load the Clothes Washer" section.
- When the washer is restarted after a pause, there will be a delay of up to 15 seconds before the cycle will continue.
- Pressing **Power Off** cancels the cycle and stops the washer.
- The Wash, Rinse and Spin indicator lights will illuminate during those portions of the cycle.

## USING THE CONTROLS

### Step 1

#### SELECT CYCLE

Control features vary by model.

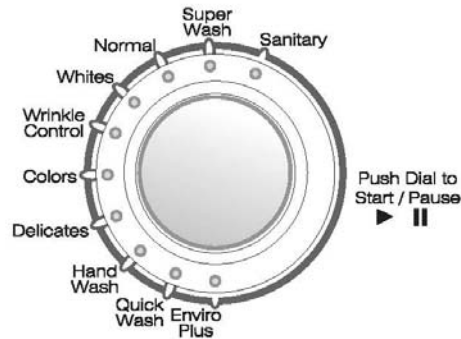

Select the appropriate cycle for the type of load.  
This will determine the tumble pattern and spin speed for the cycle.

**NOTE:** To minimize wrinkling of loads, select the Wrinkle Control cycle.

**Sanitary** (select models) – For heavily soiled, colorfast garments.  
This cycle heats the water to 150°F to eliminate bacteria.

**NOTE:** If Pause is selected during the heating portion of the Sanitary Cycle, the washer door will remain locked for your safety.

**Super Wash** – For sturdy, colorfast fabrics and heavily soiled garments.

**Normal** – For most fabrics including cottons, linens and normally soiled garments.

**Whites** (select models) – For white fabrics with or without bleach.

**Wrinkle Control** – For “wash and wear” and synthetic fabrics and lightly to normally soiled garments.

**Colors** (select models) – For bright fabrics or fabrics that may bleed.

**Delicates** – For sheer fabrics, bras and lingerie.

**Hand Wash** – For wool, silk and other hand-wash-only fabrics.  
For best results, use liquid detergent.

**Quick Wash** – For lightly soiled or wrinkled garments needed quickly.

**Enviro Plus** (select models) – For geographic areas where energy and water conservation is needed.

## USING THE CONTROLS

### Step 2

#### SELECT WASH/RINSE WATER TEMPERATURES

Press the arrow pad to select the wash and rinse water temperatures. Follow the garment care label and chart below for best results.

**Sanitary/Cold** (select models) – Heavily soiled, colorfast items. Only available with the Sanitary cycle.

**Hot/Cold** – Whites and heavily soiled color-fast items.

**ATC Warm/Warm** – Color-fast items. When warm rinse is selected, only the final rinse will be warm. The other rinses will be cold to conserve energy.

**ATC Warm/Cold** – Moderately soiled, color-fast items; most wrinkle free items.

**ATC Cold/Cold** – Brightly colored, lightly soiled items.

**Cold/Cold** – Brightly colored, very lightly soiled items; washable woolsens.

**IMPORTANT:** The washer features an automatic temperature control (ATC) to provide a warm wash of approximately 105° F, a cold wash of approximately 65° F and a warm rinse of approximately 80° F in the final rinse only on the ATC temperature selections.

**REMEMBER:** In wash water temperatures below 65° F, detergents do not dissolve well or clean well.

Control features vary by model.

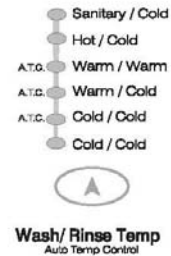

### Step 3

#### SELECT SPIN SPEED

Press the arrow pad to select the spin speed.

**Max Extract or Max Extract Plus** (select models) – Use for heavy loads such as towels and bedding. Removes more water from loads during spin.

**FABRICS NOTE:** To minimize wrinkling of wrinkle free and no-iron fabrics, do not use the Max Extract or Max Extract Plus spin option for these loads. Also, DO NOT overload the washer.

**High** (select models) – Use for underwear, t-shirts, jeans and sturdy cottons.

**Medium** – Use for jeans, wrinkle free or "wash-and-wear" items and synthetics.

**Gentle** – Use for items that will be hung up or laid flat to dry.

**Low** – Use for delicate items needing a slow spin speed because of fabric and construction.

**Drain Only** (select models) – Drains the washer without spinning. Use for extremely delicate items that cannot tolerate any spin.

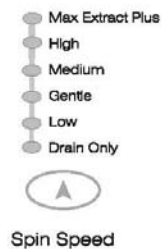

## USING THE CONTROLS

### Step 4

#### SELECT SOIL LEVEL

Press the arrow pad to select the Soil Level/washing time.

**Heavy** – Use for cleaning heavily soiled loads.

**Medium** – Use for cleaning moderately soiled loads. This setting will be appropriate for most loads.

**Light** – Use for cleaning lightly soiled loads.

Control features vary by model.

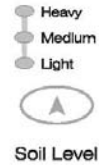

### Step 5

#### SELECT CYCLE OPTIONS

Press the appropriate pad(s) to select one or more options. The indicator light above the pad will illuminate when the option is selected.

**Delay** – Any cycle can be delayed for up to 9, 12 or 19 hours (select models) in one hour increments.

1. Make the appropriate selections for your load.
2. Press the **Delay** pad until the desired delay time appears in the display.
3. Press the **Cycle Selector** dial. The delay time will start counting down.
4. To cancel a delay, press the **Power Off** pad and restart.

**Chime** – Press the **Chime** pad to increase or decrease the end of cycle signal volume or turn the signal off.

**Control Lock** – The washer controls can be locked to prevent unwanted use by children.

1. Press the **Wash/Rinse Temp** and **Spin Speed** pads at the same time for three seconds.
2. The Control Lock light will illuminate.
3. To unlock, press the **Wash/Rinse Temp** and **Spin Speed** pads at the same time for three seconds. The Control Lock light will go out.

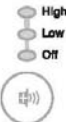

cont.



## USING THE CONTROLS

Control features vary by model.

### SELECT CYCLE OPTIONS, CONT.

Press the appropriate pad(s) to select one or more options. The indicator light above the pad will illuminate when the option is selected.

**Prewash** (select models) – Can be selected with any cycle. Add detergent to the pre-wash section of the detergent compartment. Washer fills with cold water and detergent, tumbles for 25 minutes, then drains and advances to the selected cycle.

**Stain Treat** (select models) – Adds 5 minutes to the wash for better stain removal.

**Extra Rinse** – Adds an additional rinse at the end of the cycle to more thoroughly remove laundry additives and perfumes.

**Extended Spin** (select models) – Adds additional time to the spin to remove more water from the load.

**Rinse and Spin** – Use for loads that need rinsing only or to add rinse-added fabric softener to a load.

**Spin Only** – Provides a spin to remove more water from the load.



## Step 6

### START THE WASHER

To start the washer, press the **Cycle Selector** dial. Before the washer starts to fill, it will make a series of clicking noises to check the door lock and do a quick drain.

#### Changing a Cycle

If an incorrect cycle has been accidentally selected:

1. Press the **Cycle Selector** dial.
2. Turn the **Cycle Selector** dial to the desired cycle.
3. Set the desired options for the cycle.
4. Press the **Cycle Selector** dial. The Wash indicator lights stop flashing and the new cycle starts.

#### Canceling a Cycle

To cancel a cycle:

1. Press the **Power Off** pad.
2. Select the **Rinse and Spin** or **Spin Only** option pad.
3. Press the **Cycle Selector** dial. The Spin light illuminates and the washer starts the rinse or spin.

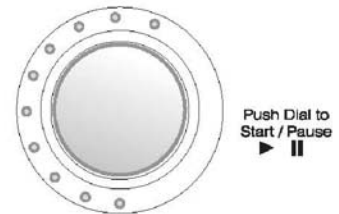

## USING THE CONTROLS

### ESTIMATED TIME DISPLAY (SELECT MODELS)

After setting the cycle and pressing **Cycle Selector** dial, the display will show the estimated minutes remaining in the cycle. The estimated time remaining may fluctuate to better indicate the wash time left in the cycle.



*Control features vary by model.*

### INDICATOR LIGHTS

**Door Lock** – lights whenever the door of the clothes washer is locked. The door can be unlocked by pressing the **Cycle Selector** dial to pause the washer.

**Control Lock** – The washer controls can be locked to prevent unwanted use by children.

1. Press the **Wash/Rinse Temp** and **Spin Speed** pads at the same time for three seconds.
2. The Control Lock light will illuminate.
3. To unlock, press the **Wash/Rinse Temp** and **Spin Speed** pads at the same time for three seconds. The Control Lock light will go out.



**Cycle Indicator Lights** – The Wash, Rinse and Spin lights at the top of the control panel will illuminate progressively to indicate when the washer is in those portions of the cycle. These lights will flash when the cycle has been paused.

**Pad Indicator Lights** – The indicator lights above the pads will illuminate when the pad is selected.

**Cycle Setting Indicator Lights** – Indicator lights by the cycle settings will illuminate when the selection is made.



## WATER USE

### INTELLIFILL™ WATER LEVEL CONTROL

The amount of water used will vary with each load. The Maytag Neptune® clothes washer will automatically provide the appropriate amount of water for efficient cleaning performance and conservation of water and energy. Fill time will vary depending on water pressure.

## DETERGENT USE

Your Maytag Neptune® washer is designed to use high efficiency (HE) detergents.



- For best cleaning results, use a high efficiency detergent such as Tide HE, Wisk HE, Cheer HE or Gain HE®. High efficiency detergents contain suds suppressors which reduce or eliminate suds. When less suds are produced, the load tumbles more efficiently and cleaning results are maximized.

If HE detergent is not available, regular detergent may be used.

- If using regular detergent formulated for top-loading washers, it is important to pay close attention to the soil level of the load, load size, and water hardness\*\*. **To avoid over-sudsing, which interferes with tumbling, rinsing and spinning and causes extended cycle times, reduce the amount of detergent used with soft water or with small or lightly soiled loads.**

**NOTE:** Reducing the amount of detergent may reduce cleaning. It is important to pretreat stains, sort carefully by color and soil level and avoid overloading.

\* Brand names are trademarks of the respective manufacturers.

\*\* To determine water hardness in your area, contact your local water utility or State University Extension office in your area.

## FEATURES

### AUTOMATIC DISPENSER

The washer has separate compartments for dispensing detergent and color-safe bleach, chlorine bleach and fabric softener. All laundry additives are added to their respective compartments before starting the washer.

**The Automatic Dispenser MUST ALWAYS be in place before starting the washer. DO NOT open the Automatic Dispenser when the washer is running.**

**To use:**

1. Pull out the dispenser drawer on the left side of the control panel.
2. Fill appropriate compartments with laundry additives, being careful not to overfill or spill additives.
3. Slide the dispenser drawer carefully and completely back into the compartment.

### DETERGENT COMPARTMENT

1. Pour the recommended amount of laundry detergent directly into the detergent compartment before starting the washer.
2. If color-safe bleach is to be used, it should be added with detergent to the detergent compartment.
  - When adding color-safe bleach with detergent, it is best if both laundry products are in the same form; granular or liquid.

**NOTE:** If using liquid detergent, lower the Detergent Selector and add the detergent to the Detergent Compartment.

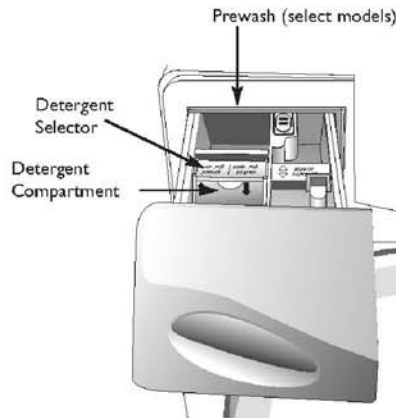

### PREWASH COMPARTMENT (SELECT MODELS)

When using the Prewash option (select models), detergent should be added to both the Prewash Compartment and the Detergent Compartment. The detergent will be automatically dispensed during prewash.

- If high efficiency (HE) detergent is used, add 1/3 of the recommended amount to the Prewash Compartment and 2/3 of the recommended amount to the Detergent Compartment.
- If regular detergent is used, add 1/6 of the recommended amount to the Prewash Compartment and 1/3 of the recommended amount to the Detergent Compartment.

## FEATURES

### BLEACH COMPARTMENT

(Liquid Chlorine Bleach Only)

1. Add chlorine bleach to the Bleach Compartment. **DO NOT** exceed the MAX FILL line.
2. Avoid splashing or over-filling the compartment.
3. The washer automatically dispenses bleach into the tub at the appropriate time.
4. The dispenser automatically dilutes liquid chlorine bleach before it reaches the wash load.

#### NOTES:

- **Never pour undiluted liquid chlorine bleach directly onto the load or into the tub.** It is a powerful chemical and can cause fabric damage, such as weakening of the fibers or color loss, if not used properly.
- If you prefer to use color-safe, non-chlorine bleach, add it to the appropriate detergent compartment. **DO NOT pour color-safe bleach into the chlorine bleach dispenser.**

### FABRIC SOFTENER COMPARTMENT

1. Pour the recommended amount of liquid fabric softener into the softener compartment. For smaller loads, use less than one cap full.
2. Fabric softener should be diluted with warm water until it reaches MAX FILL in the compartment.
3. The dispenser automatically releases liquid fabric softener at the proper time during the rinse cycle.

#### NOTES:

- Use the softener compartment **ONLY** for liquid fabric softeners.
- **DO NOT** use the Downy Ball<sup>®</sup> with this washer. It will not add fabric softener at the appropriate time. Use the automatic dispenser.

\* Brand names are trademarks of the respective manufacturers.

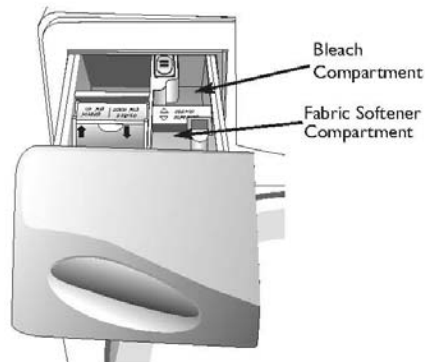

## CARE AND CLEANING

**Turn off the water faucets after finishing the day's washing.** This will shut off the water supply to the clothes washer and prevent the unlikely possibility of damage from escaping water. Leave the door open to allow the inside of the washer to dry out.

Use a soft cloth to wipe up all detergent, bleach or other spills as they occur.

Clean the following as recommended:

**Control Panel** – Clean with a soft, damp cloth. Do not use abrasive powders or cleaning pads. Do not spray cleaners directly on the panel.

**Cabinet** – Clean with soap and water.

### CLEANING THE INTERIOR

Clean the interior of the washer periodically to remove any dirt, soil, odor, mold, mildew or bacteria residue that may remain in the washer as a result of washing clothes. We recommend taking the following steps every 60 to 120 days to clean and freshen your washer interior. The frequency with which the washer should be cleaned and freshened depends on factors such as usage, the amount of dirt, soil or bacteria being run through your washer, or the use of cold water. Failure to follow these instructions may result in unsatisfactory conditions, including unpleasant odor and/or permanent stains on the washer or washload.

#### To clean and freshen the washer interior:

1. Make a solution of one cup chlorine bleach and two cups warm water. Be careful not to spill or splash the bleach solution.
2. Wipe the door seal with bleach solution and a soft cloth.
3. Fill bleach dispenser with chlorine bleach.
4. Run the washer through a complete cycle using hot water.
5. Repeat the wash cycle if necessary.

Hard water deposits may be removed, if needed. Use a recommended cleaner labeled clothes washer safe.

### CLEANING THE DISPENSERS

The Automatic Dispenser may need to be cleaned periodically due to laundry additive buildup.

1. Press the release lever on the inside of the dispenser and pull out.



2. Remove the cups from the fabric softener and bleach compartments.
3. Wash all of the parts under running water.
4. Clean the dispenser recess with a soft brush.
5. Reinsert the cups, pushing them firmly into place.
6. Push the dispenser back into place.
7. Run a Rinse & Spin cycle without any load in the washer.

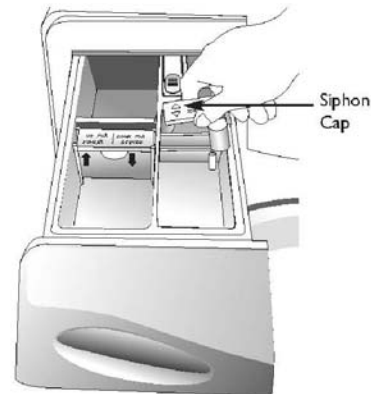

## STORING THE CLOTHES WASHER

Washers can be damaged if water is not removed from hoses and internal components before storage. Prepare the washer for storage as follows:

- Select the **Quick Wash** cycle and add bleach to the automatic dispenser. Run the washer through the cycle without a load.
- Turn the water faucets off and disconnect the inlet hoses.

- Disconnect the clothes washer from the electrical supply and leave the washer door open to let air circulate inside the tumbler.
- If the washer has been stored in below-freezing temperatures, allow time for any water left over in the washer to thaw out before use.

For information on long-term storage or storage of your washer during extreme cold temperatures, call Maytag Customer Service toll-free at 1-800-688-9900 USA or 1-800-688-2002 Canada. U.S. customers using TTY for deaf, hearing impaired or speech impaired, call 1-800-688-2080.

## TROUBLESHOOTING

For problem laundry solutions (i.e. fabric damage, residue, tangling) and special laundry care procedures, see the enclosed **Laundrying Tips** booklet.

### CHECK THESE POINTS IF YOUR MAYTAG NEPTUNE® WASHER...

<b>Freshening your washer</b>	<ul style="list-style-type: none"> <li>• See Cleaning the Interior, page 11.</li> </ul>
<b>The washer will not start</b>	<ul style="list-style-type: none"> <li>• Make sure door is firmly closed.</li> <li>• Make sure the washer is plugged in.</li> <li>• Make sure the water source faucets are turned on.</li> <li>• Make sure to press the <b>Cycle Selector</b> dial to start the washer.</li> <li>• Make sure the Control Lock is not activated, see page 6.</li> <li>• Before the washer starts to fill, it will make a series of clicking noises to check the door lock and do a quick drain.</li> </ul>
<b>No water or insufficient water supply</b>	<ul style="list-style-type: none"> <li>• Turn both faucets on fully.</li> <li>• Make sure the door is tightly closed.</li> <li>• Make sure the washer is plugged in.</li> <li>• Check fuse or reset circuit breaker.</li> <li>• Press the <b>Cycle Selector</b> dial to start the washer.</li> <li>• Straighten water inlet hoses.</li> <li>• Disconnect hoses and clean screens. Hose filter screens may be plugged.</li> <li>• Open and close the door, then press the <b>Cycle Selector</b> dial.</li> </ul>
<b>Detergent remains in the automatic dispenser after the wash cycle is complete</b>	<ul style="list-style-type: none"> <li>• Make sure the washer is running with sufficient water pressure. See Installation Instructions.</li> <li>• Make sure the Detergent Selector is in the upper position when using granular detergent.</li> </ul>
<b>Washer vibrates or is too noisy</b>	<ul style="list-style-type: none"> <li>• Make sure the washer is set on a level surface. If the surface is not level, adjust the washer feet to level the appliance. See Installation Instructions.</li> <li>• Make sure that the shipping bolts are removed. See Installation Instructions.</li> <li>• Make sure the washer is not touching any other object.</li> <li>• Make sure the laundry load is balanced.</li> </ul>

CONT.

# CLOTHES WASHER WARRANTY

## Neptune® Washer Warranty

### Full One-Year Warranty

For one (1) year from the date of original retail purchase, any part with fails in normal home use will be repaired or replaced free of charge.

### Limited Warranty

After the first year from the date of original retail purchase, through the time periods listed below, the parts designated below which fail in normal home use will be repaired or replaced free of charge for the part itself, with the owner paying all other costs including labor, mileage, transportation, trip charge and diagnostic charge, if required.

**Second Year** – All parts.

**Third Through Fifth Year** – Drive motor.

**Third Through Lifetime** – Stainless steel inner wash basket.

**Additional Limited Warranty Against Rust-Through** Should an exterior cabinet, including the top and door, rust through during the one year period starting from the date of retail purchase, repair or replacement will be made free of charge. After the first, and through the fifth year, repair or replacement will be made free of charge for the part itself, with the owner paying all other costs, including labor, mileage, transportation, trip charge and diagnostic charge, if required.

**Please Note:** This full warranty and the limited warranty apply when the washer is located in the United States or Canada. Washers located elsewhere are covered by the limited warranty only, including parts which fail during the first two years.

### Canadian Residents

This warranty covers only those appliances installed in Canada that have been listed with the Canadian Standards Association unless the appliances are brought into Canada due to transfer of residence from the United States to Canada.

The specific warranties expressed above are the **ONLY** warranties provided by the manufacturer. This warranty gives you specific legal rights, and you may also have other rights that vary from state to state.

Use & Care Guides, service manuals and parts information are available from Maytag Services™, Maytag Customer Assistance.

## What is Not Covered By These Warranties:

1. Conditions and damages resulting from any of the following:
  - a. Improper installation, delivery or maintenance.
  - b. Any repair, modification, alteration, or adjustment not authorized by the manufacturer or an authorized servicer.
  - c. Misuse, abuse, accidents or unreasonable use.
  - d. Incorrect electric current, voltage or supply.
  - e. Improper setting of any control.
2. Warranties are void if the original serial numbers have been removed, altered or cannot be readily determined.
3. Light Bulbs
4. Products purchased for commercial or industrial use.
5. The cost of service or service call to:
  - a. Correct installation errors.
  - b. Instruct the user on the proper use of the product.
  - c. Transport the appliance to the servicer.
6. Consequential or incidental damages sustained by any person as a result of any breach of these warranties.

Some states do not allow the exclusion or limitation of consequential or incidental damages, so the above exclusion may not apply.

## To Obtain Warranty Service

To locate an authorized service company in your area, contact the dealer from whom your appliance was purchased; or call Maytag Services™, Maytag Customer Assistance. Should you not receive satisfactory warranty service, please call or write:

Maytag Services™  
Attn: CAIR® Center  
P.O. Box 2370  
Cleveland, TN 37320-2370  
**U.S. 1-800-688-9900**  
**Canada 1-800-688-2002**  
**U.S. Customers using TTY for deaf, hearing impaired or speech impaired, call 1-800-688-2080.**

## NOTE:

When contacting Maytag Services™, Maytag Customer Assistance about a service problem, please include the following:

- a. Your name, address and telephone number;
- b. Model number and serial number of your appliance;
- c. Name and address of your dealer and the date the appliance was purchased;
- d. A clear description of the problem you are having;
- e. Proof of purchase.

Maytag • 403 West Fourth Street North • P. O. Box 39 • Newton, Iowa 50208

# TROUBLESHOOTING

## INFORMATION CODES

Information codes may be displayed to help you better understand what is occurring with the washer.

Code Symbol	Meaning	Solution
dc	Unbalanced load prevented the washer from spinning.	Redistribute the load, press the Cycle Selector dial.
dl	Door is unlocked when washer is running.	Press Power Off pad then restart the cycle. If the code reappears, call for service, see below.
ds	Door is open when washer is running.	Close the door tightly and restart the cycle. If the code reappears, call for service, see below.
fl	The washer failed to lock the door.	Close the door tightly and restart the cycle. If the code reappears, call for service, see below.
ht	Water temperature control problem (Heater Control problem)	Call for service, see below.
le	The washer has tried to fill but has not reached the proper water level.	Call for service, see below.
lo	The door will not unlock.	Make sure the door is firmly closed. Push the Power Off pad to turn off the washer, and then turn it on using any pad. If the code reappears, call for service, see below.
e3	Motor not running properly.	Restart the cycle pressing the Cycle Selector dial. If the code reappears, call for service, see below.
nd	The washer is not draining.	See Troubleshooting "The washer does not drain and/or spin", page 13. If problem continues, call for service, see below.
nf	The washer has tried to fill but was unsuccessful.	Make sure the water faucets are open all the way. Check for kinked hoses. Check inlet screens on fill hoses.
sr	Problem with control.	Call for service, see below.
pf	Electric service was lost when washer was running.	Restart the cycle by pressing the Cycle Selector dial.

For any codes not listed above, call Maytag Customer Service at 1-800-688-9900 USA or 1-800-688-2002 Canada.



# CLOTHES WASHER WARRANTY

## Neptune® Washer Warranty

### Full One-Year Warranty

For one (1) year from the date of original retail purchase, any part with fails in normal home use will be repaired or replaced free of charge.

### Limited Warranty

After the first year from the date of original retail purchase, through the time periods listed below, the parts designated below which fail in normal home use will be repaired or replaced free of charge for the part itself, with the owner paying all other costs including labor, mileage, transportation, trip charge and diagnostic charge, if required.

**Second Year** – All parts.

**Third Through Fifth Year** – Drive motor.

**Third Through Lifetime** – Stainless steel inner wash basket.

**Additional Limited Warranty Against Rust-Through** Should an exterior cabinet, including the top and door, rust through during the one year period starting from the date of retail purchase, repair or replacement will be made free of charge. After the first, and through the fifth year, repair or replacement will be made free of charge for the part itself, with the owner paying all other costs, including labor, mileage, transportation, trip charge and diagnostic charge, if required.

**Please Note:** This full warranty and the limited warranty apply when the washer is located in the United States or Canada. Washers located elsewhere are covered by the limited warranty only, including parts which fail during the first two years.

### Canadian Residents

This warranty covers only those appliances installed in Canada that have been listed with the Canadian Standards Association unless the appliances are brought into Canada due to transfer of residence from the United States to Canada.

The specific warranties expressed above are the ONLY warranties provided by the manufacturer. This warranty gives you specific legal rights, and you may also have other rights that vary from state to state.

Use & Care Guides, service manuals and parts information are available from Maytag Services<sup>SM</sup>, Maytag Customer Assistance.

## What is Not Covered By These Warranties:

1. Conditions and damages resulting from any of the following:
  - a. Improper installation, delivery or maintenance.
  - b. Any repair, modification, alteration, or adjustment not authorized by the manufacturer or an authorized servicer.
  - c. Misuse, abuse, accidents or unreasonable use.
  - d. Incorrect electric current, voltage or supply.
  - e. Improper setting of any control.
2. Warranties are void if the original serial numbers have been removed, altered or cannot be readily determined.
3. Light Bulbs
4. Products purchased for commercial or industrial use.
5. The cost of service or service call to:
  - a. Correct installation errors.
  - b. Instruct the user on the proper use of the product.
  - c. Transport the appliance to the servicer.
6. Consequential or incidental damages sustained by any person as a result of any breach of these warranties.

Some states do not allow the exclusion or limitation of consequential or incidental damages, so the above exclusion may not apply.

## To Obtain Warranty Service

To locate an authorized service company in your area, contact the dealer from whom your appliance was purchased; or call Maytag Services<sup>SM</sup>, Maytag Customer Assistance. Should you not receive satisfactory warranty service, please call or write:

Maytag Services<sup>SM</sup>  
Attn: CAIR® Center  
P.O. Box 2370  
Cleveland, TN 37320-2370  
**U.S. 1-800-688-9900**  
**Canada 1-800-688-2002**  
**U.S. Customers using TTY for deaf, hearing impaired or speech impaired, call 1-800-688-2080.**

### NOTE:

When contacting Maytag Services<sup>SM</sup>, Maytag Customer Assistance about a service problem, please include the following:

- a. Your name, address and telephone number;
- b. Model number and serial number of your appliance;
- c. Name and address of your dealer and the date the appliance was purchased;
- d. A clear description of the problem you are having;
- e. Proof of purchase.

Maytag • 403 West Fourth Street North • P. O. Box 39 • Newton, Iowa 50208