

Manual No: 26110701



Developmental Resources



MODEL NUMBERS:

110.42822200 110.42832200
110.42824200 110.42826200
110.42834200 110.42836200
110.42922200 110.42932200
110.42924200 110.42934200
110.42926200 110.42936200



HE³ HE^{3t}

Front-Loading Automatic Washer

FIELD COURSE 9373

TABLE OF CONTENTS

SAFETY FIRST	III
MODEL/SERIAL NUMBER PLATE	IV
INSTALLATION CONSIDERATIONS	1-1
Installation Requirements	1-1
Installation Instructions (Washer)	1-3
Installation Instructions (Pedestal)	1-6
THEORY OF OPERATIONS	2-1
COMPONENT ACCESS	3-1
Component Location	3-1
Component Access	3-2
COMPONENT TESTING	4-1
Central Control Unit	4-1
Component Checks	4-2
Motor Control Unit	4-4
Line Filter	4-5
Dispenser	4-5
Pressure Switch	4-6
Heating Element and Temperature Sensor	4-6
DIAGNOSIS AND TROUBLESHOOTING	5-1
Suds Detection	5-1
Door Locking and Unlocking	5-2
Unbalance Detection Routine	5-3
Error Codes	5-4
Diagnostic Test	5-8
Troubleshooting Chart	5-10
Cycle Charts	5-12
WIRING DIAGRAM	6-1
TECH TIPS	7-1

A companion videotape presentation, Part Number 26110701V,
is available for this Service Manual.

Your safety and the safety of others are very important.

We have provided many important safety messages in this manual and on the appliance. Always read and obey all safety messages.



This is the safety alert symbol.

This symbol alerts you to potential hazards that can kill or hurt you and others.

All safety messages will follow the safety alert symbol and either the word "DANGER" or "WARNING." These words mean:

! DANGER

You can be killed or seriously injured if you don't immediately follow instructions.

! WARNING

You can be killed or seriously injured if you don't follow instructions.

All safety messages will tell you what the potential hazard is, tell you how to reduce the chance of injury, and tell you what you can happen if the instructions are not followed.

! WARNING



ELECTRICAL SHOCK HAZARD

Disconnect power before servicing.

Replace all panels before operating.

Failure to do so can result in death or electrical shock.

! WARNING



ELECTRICAL SHOCK HAZARD

Plug into a grounded 3 prong outlet.

Do not remove ground prong.

Do not use adapter.

Do not use an extension cord.

Failure to follow these instructions can result in death, fire, or electrical shock.

MODEL/SERIAL NUMBER PLATE

SERIAL NUMBER DESIGNATOR

SERIAL NUMBER	CS	L	36	50001
MANUFACTURING SITE	CS = Shorndorf, Germany			
YEAR OF MANUFACTURE	L = 2001			
WEEK OF MANUFACTURE				
PRODUCT SEQUENCE NUMBER				

Model/Serial
Number Plate
(Left side of
Door Opening)



KENMORE MODEL NUMBER DESIGNATOR

MODEL NUMBER	110	42	82	2	2	0	0
SOURCE CODE							
PRODUCT	42 = Front-Loading Washer						
FEATURE LEVEL							
COLOR CODE	2 = White/White 4 = Bisque/Bisque 6 = Graphite/Graphite						
YEAR OF INTRODUCTION	2 = 2001						
DECADE	0 = 2000						
ENGINEERING CHANGE	0 = Basic Release; 1 = First Revision; 2 = Second Revision						

Section One

INSTALLATION CONSIDERATIONS

INSTALLATION REQUIREMENTS

Tools and Parts

Assemble the necessary tools and supplies before beginning the washer installation. The parts supplied are in the washer drum.

Tools needed for connecting the water inlet hoses

- Pliers (that open to 1 9/16 in. [39.5 mm])
- Flashlight (optional)

Tools needed for installation

- Open end wrench 5/8 in. (17 mm) and 1/2 in. (13 mm)
- Level
- Wood block (2" x 4")
- Ruler or measuring tape

Parts supplied:



Beaded strap



Transport bolt hole plug
(4)

Alternate Parts You May Need

Parts listed are available from your local Sears store or Sears Service Center.

If You Have	If You Have You Will Need to Buy
Laundry tub or standpipe taller than 96 in. (2.4 m)	Sump pump system (if not already available)
Overhead sewer	Standard 20 gal. (76 L), 30 in. (76.2 cm) tall drain tub or utility sink and sump pump (available from local plumbing suppliers)
Floor drain	Siphon break, Part Number 285834; additional drain hose Part Number 8318155; and connector kit, Part Number 285835
Drain hose too short	Drain hose extension kit, Part Number 285863
Water faucets beyond reach of fill hoses	2 longer water fill hoses: 6 ft. (1.8 m) Part Number 76314, 10 ft. (3.0 m) Part Number 350008

Optional Pedestal

A pedestal may be purchased separately for this washer. This pedestal will add about 14 inches to the height of your unit for a total vertical height of approximately 52 inches (132 cm).

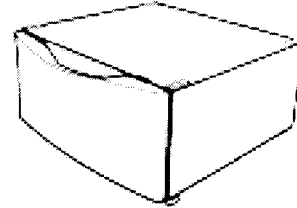

Optional Pedestal

This pedestal is available in three colors:

- White** - Part Number 4282
- Bisque** - Part Number 4284
- Graphite** - Part Number 4286

To order, call your local Sears store or Sears Service Center.

Location Requirements

Selecting the proper location for your washer improves performance and minimizes noise and possible washer "walk."

Your washer can be installed under a custom counter, or in a basement, laundry room, closet, or recessed area. (See "Drain System.")

Companion appliance location requirements should also be considered. Proper installation is your responsibility.

You will need

- A water heater set to deliver 120°F (49°C) water to the washer.
- A grounded electrical outlet located within 5 ft. (1.5 m) of where the power cord is attached to the back of the washer. (See "Electrical Requirements.")
- Hot and cold water faucets located within 4 ft. (1.2 m) of the hot and cold water fill valves, and water pressure of 20-100 psi (137.9-689.6 kPa).
- A level floor with a maximum slope of 1 in. (2.5 cm) under entire washer. Installing the washer on carpeting is not recommended.
- A sturdy and solid floor to support the washer with a total weight (water and load) of 400 lbs. (180 kg).

Do not operate your washer in temperatures below 32°F (0°C). Some water can remain in the washer and can cause damage in low temperatures.

Washer Dimensions

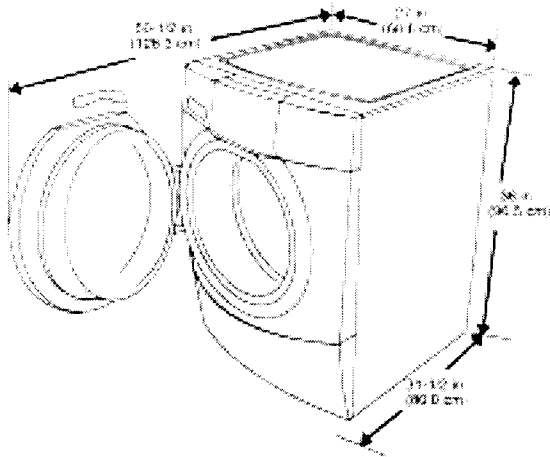

Custom undercounter installation

The dimensions shown are for the minimum spacing allowed.

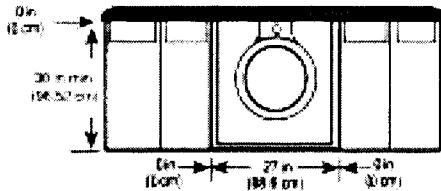

Recessed area or closet installation

The dimensions shown are for the minimum spacing allowed

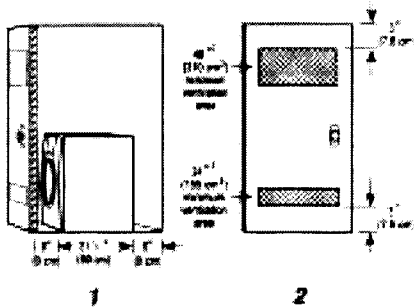

1. Side view - closet or confined area
2. Closet door with vents

- Additional spacing should be considered for ease of installation and servicing.
- Additional clearances might be required for wall, door and floor moldings.
- Additional spacing of 1 in. (2.5 cm) on all sides of the washer is recommended to reduce noise transfer.
- For closet installation, with a door, the minimum ventilation openings in the top and bottom of the door are required (view 2). Louvered doors with equivalent ventilation openings in the top and bottom are acceptable.

Drain System

The washer can be installed using the standpipe drain system (floor or wall), the laundry tub drain system, or the floor drain system. Select the drain hose installation method you need. (See "Alternate Parts You May Need.")

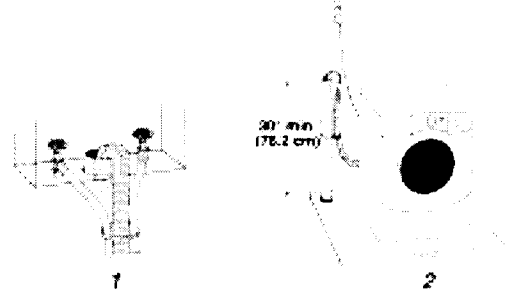

Standpipe drain system - wall or floor (view 1 & 2)

The standpipe drain requires a minimum diameter standpipe of 2 in. (5 cm). The minimum carry-away capacity can be no less than 17 gal (64 L) per minute.

The top of the standpipe must be at least 30 in. (76.2 cm) high and no higher than 96 in. (2.4 m) from the bottom of the washer.

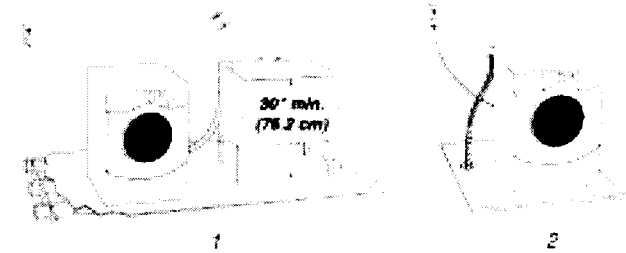

The laundry tub needs a minimum 20 gal. (76 L) capacity. The top of the laundry tub must be at least 30 in. (76.2 cm) above the floor.

Floor drain system (view 2)

The floor drain system requires a siphon break that may be purchased separately. (See "Alternate Parts You May Need.")

The siphon break must be a minimum of 28 in. (71 cm) from the bottom of the washer. Additional hoses might be needed.

Electrical Requirements

! WARNING



ELECTRICAL SHOCK HAZARD

Plug into a grounded 3 prong outlet.

Do not remove ground plug.

Do not use an adapter.

Do not use an extension cord.

Failure to follow these instructions can result in death or electrical shock.

- A 120-volt, 60-Hz., AC-only, 15- or 20-ampere, fused electrical supply is required. Time-delay fuse or circuit breaker is recommended. It is recommended that a separate circuit serving only this appliance be provided.
- This washer is equipped with a power supply cord having a 3 prong ground plug.
- To minimize possible shock hazard, the cord must be plugged into a mating, 3 prong, ground-type outlet, grounded in accordance with local codes and ordinances. If a mating outlet is not available, it is the personal responsibility and obligation of the customer to have the properly grounded outlet installed by a qualified electrician.
- If codes permit and a separate ground wire is used, it is recommended that a qualified electrician determine that the ground path is adequate.
- Do not ground to a gas pipe.
- Check with a qualified electrician if you are not sure the washer is properly grounded.
- Do not have a fuse in the neutral or ground circuit.

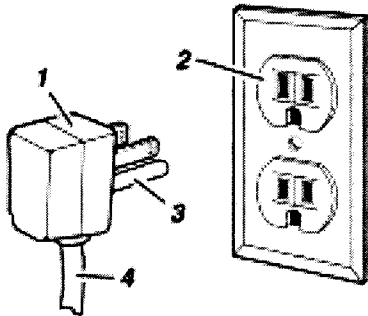

1. 3 prong grounding plug
2. 3 prong grounding-type wall receptacle
3. Grounding prong
4. Power supply cord

GROUNDING INSTRUCTIONS

For a grounded, cord-connected washer:

This washer must be grounded. In the event of a malfunction or breakdown, grounding will reduce the risk of electrical shock by providing a path of least resistance for electric current. This washer is equipped with a cord having an equipment-grounding conductor and a grounding plug. The plug must be plugged into an appropriate outlet that is properly installed and grounded in accordance with all local codes and ordinances.

WARNING: Improper connection of the equipment-grounding conductor can result in a risk of electric shock. Check with a qualified electrician or serviceman if you are in doubt as to whether the appliance is properly grounded.

Do not modify the plug provided with the appliance – if it will not fit the outlet, have a proper outlet installed by a qualified electrician.

For a permanently connected washer:

This washer must be connected to a grounded metal, permanent wiring system, or an equipment grounding conductor must be run with the circuit conductors and connected to the equipment-grounding terminal or lead on the appliance.

INSTALLATION INSTRUCTIONS

Remove Transport System

! WARNING

Excessive Weight Hazard

Use two or more people to move and install washer.

Failure to do so can result in back or other injury.

IMPORTANT: Position the washer so that the rear of the unit is within approximately 3 feet (90 cm) of the final location.

There are 4 bolts in the rear panel of the washer that support the suspension system during transportation.

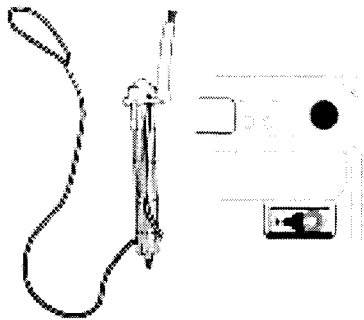

1. Using a ½ in. (13 mm) wrench, loosen each of the bolts.
2. Once the bolt is loose, move it to the center of the hole and completely pull out the bolt, including the plastic spacer covering the bolt and the cable attached to the bolt. The power cord will be attached to all 4 bolts.

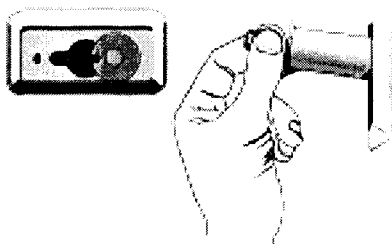

3. Once all 4 bolts are removed, remove the power cord from each bolt holder, and discard bolts, plastic spacers, and cables.
4. Close the holes with the transport bolt hole plugs.

Route the Drain Hose

Proper routing of the drain hose protects your floors from damage due to water leakage. Carefully read and follow these instructions.

The drain hose is connected to your washer.

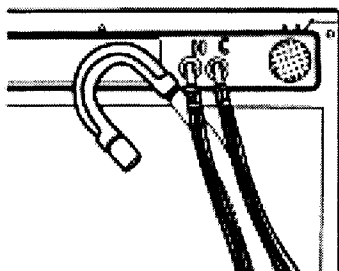

To prevent drain water from going back into the washer:

- Do not straighten the drain hose, and do not force excess drain hose into standpipe. Hose should be secure, but loose enough to provide a gap for air.
- Do not lay excess hose on the bottom of the laundry tub.

Floor drain

You may need additional parts. (See Floor Drain under "Alternate Parts You May Need.")

Connect the Inlet Hoses

Connect the inlet hoses to the water faucets

Make sure the washer drum is empty.

1. Attach the hose with the red color indicator to the hot water faucet. Screw on coupling by hand until it is seated on the washer.
2. Attach the hose with the blue color indicator to the cold water faucet. Screw on coupling by hand until it is seated on the washer.
3. Using pliers, tighten the couplings with an additional two-thirds turn.

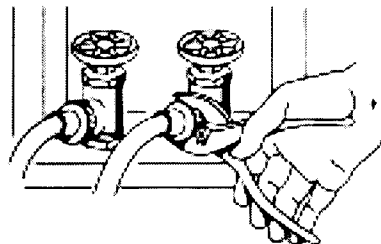

NOTE: Do not overtighten. Damage to the coupling can result.

4. Turn on the water faucets and check for leaks.
NOTE: Replace inlet hoses after 5 years of use to reduce the risk of hose failure. Record hose installation or replacement dates on the hoses for future reference.

Periodically inspect and replace hoses if bulges, kinks, cuts, wear, or leaks are found.

Secure the Drain Hose

1. Drape the power cord over the washer top.
2. Secure the drain hose to the laundry tub leg or standpipe with the beaded strap provided. (See illustration.)

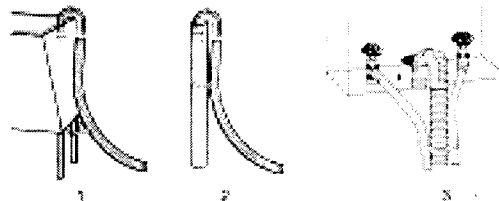

If the washer faucets and the drain standpipe are recessed, put the hooked end of the drain hose in the standpipe. Tightly wrap the beaded strap around the water inlet hoses and the drain hose.

Do not force excess drain hose into the standpipe.

Level the Washer

Properly leveling your washer prevents excessive noise and vibration.

1. Check the levelness of the washer by placing a level on the top edge of the washer, first side-to-side, then front-to-back.



If the washer is against a wall, move the washer out slightly before tipping back. If the washer is not level, first prop the front with a wood block (2" x 4") and adjust the feet as necessary; then prop the back and adjust feet as necessary. Repeat this step until washer is level.

2. After the washer is level, use a 5/8 in. (17 mm) open-end wrench to turn the nuts on the feet tightly against the washer cabinet. All 4 feet must be tightened. If the nuts are not tight against the washer cabinet, the washer may vibrate.
3. Slide the washer to its final location.
4. Confirm the levelness of the washer.

Complete Installation

1. Check the electrical requirements. Be sure that you have the correct electrical supply and the recommended grounding method. (See "Electrical Requirements.")
2. Check to be sure all parts are now installed. If there is an extra part, go back through the steps to see which step was skipped.

! WARNING



ELECTRICAL SHOCK HAZARD

Plug into a grounded 3 prong outlet.

Do not remove ground plug.

Do not use an adapter.

Do not use an extension cord.

Failure to follow these instructions can result in death or electrical shock.

3. Check to be sure you have all of your tools.
4. Dispose/recycle all packaging materials.
5. Check to be sure the water faucets are on.
6. Check for leaks around faucets and inlet hoses.
7. Plug into a grounded 3 prong outlet.
8. Read "Washer Use."

To test and to clean your washer, measure ½ the normal recommended amount of powdered or liquid High Efficiency (HE) detergent or ¼ the normal recommended amount of regular powdered or liquid detergent. Pour the detergent into the detergent dispenser. Select NORMAL/CASUAL, and then select START. Allow the washer to complete one whole cycle.

INSTALLATION INSTRUCTIONS

Pedestal

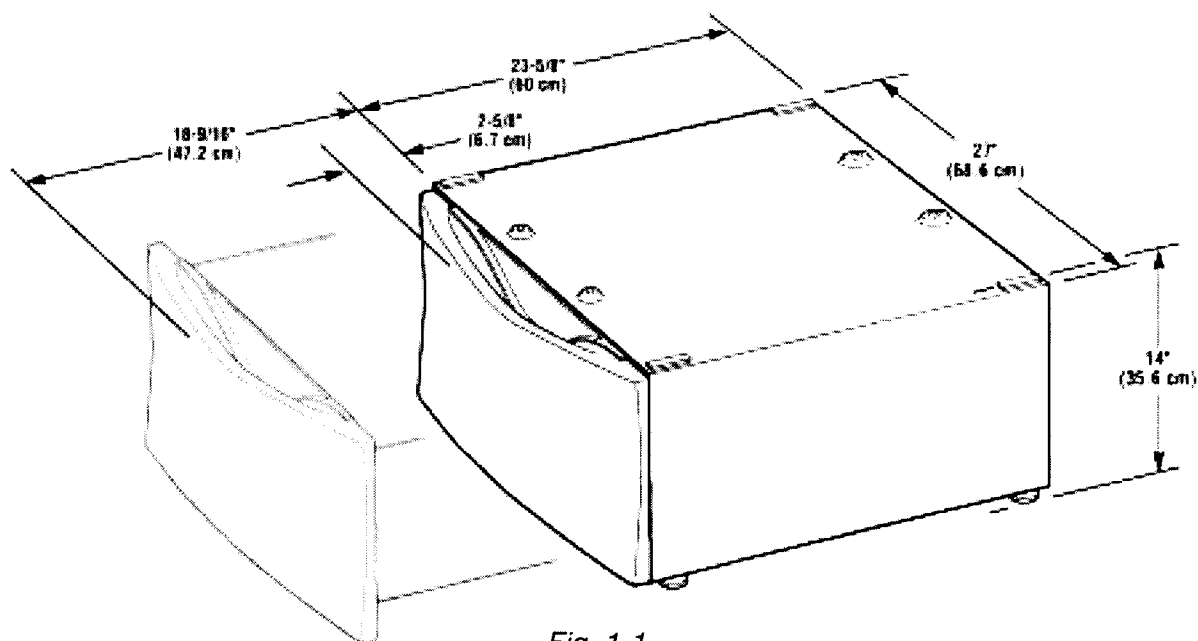

Fig. 1-1

! WARNING

EXCESSIVE WEIGHT HAZARD

Use two or more people to move washer and dryer.

Failure to do so can result in back or other injury.

Before you start...

Important: If the washer is already installed, it must be uninstalled.

See installation instructions that came with the washer for tools required.

Uninstalling the Washer

1. Turn off the hot and cold water faucets.
2. Briefly start the wash cycle to release any pressure in the fill hoses.
3. Unplug the power supply cord.

4. Remove the "HOT" and "COLD" fill hoses from the back of the washer.
5. Disconnect the drain hose from the washer and drain any water in the hose into a bucket.
6. Pull the washer away from the wall so it can be tipped on its back.
7. Protect the floor with a large piece of cardboard cut from the pedestal carton. Lay the washer on its back so that the cardboard is under the entire lower back edge of the washer. (Fig. 1-2) Go to "Installing the Pedestal".

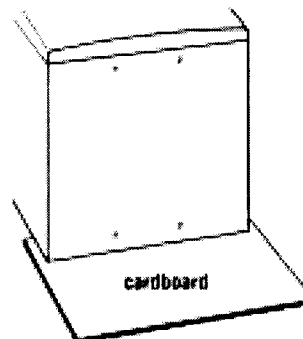

Fig. 1-2

Installing the Pedestal

1. Open the pedestal drawer. Remove the envelope taped inside the drawer. This envelope contains four (4) #12 x 5/8" (1.6 cm) hex head sheet metal screws that will be used in Steps 4 and 5.
2. Remove the Phillips head screw from both drawer sides and set the aside. (Fig. 1-3) Remove the drawer and set it aside. Push the slides back into the pedestal.

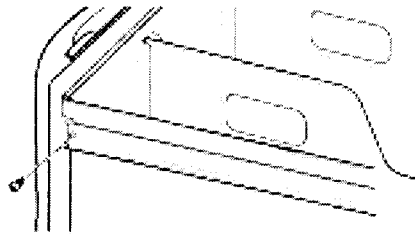

Fig. 1-3

3. If the washer has feet installed, remove them. DO NOT install the feet that came with a new washer.
4. Partially install the two (2) lower #12 x 5/8" (1.6 cm) hex head sheet metal screws leaving a space of about 3/8" (2 cm) between the screw head and the bottom of the washer. (Fig. 1-4)

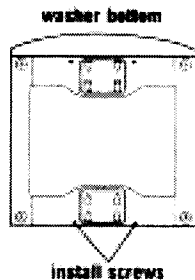

Fig. 1-4

5. Move the pedestal against the washer bottom. Slide the pedestal's keyhole slots over the lower two (2) partially installed screws. (Fig. 1-5)

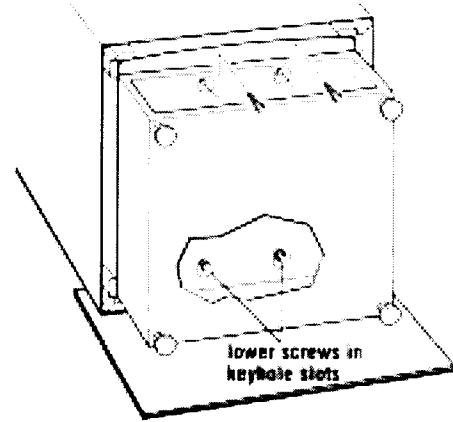

Fig. 1-5

Lift the pedestal toward the front of the washer and install the two (2) remaining hex head sheet metal screws. **Do not tighten completely.**

6. Tip the washer and pedestal assembly back to an upright position. Remove protective cardboard.
7. Slide the washer close to its final location.

Helpful Tip: to make sliding the washer to its final location easier, spray the floor behind the washer with window cleaner.

If the washer is still in its packaging, follow the instructions on the packaging and remove it.

8. Follow the Installation Instructions that came with the washer to finish installing or reinstalling. (i.e., hoses, vents, etc.)
9. Level the washer from side to side and front to back.

Place a level on the top. Locate the 1/4" (6.4 mm) hex nut on the top of each pedestal foot. Reach inside the pedestal and use a 1/4" (6.4 mm) hex head ratchet or open-end wrench to adjust the feet up or down as needed to level the washer. (Fig. 1-6)

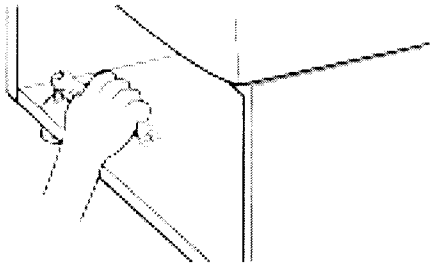

Fig. 1-6

10. When the washer is level, use a 9/16" (14.3 mm) open-end wrench to securely tighten all four (4) feet locknuts against the pedestal. (Fig. 1-7) **The locknuts must be tightened.**

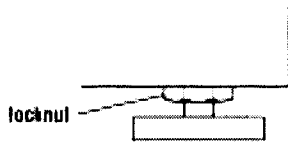

Fig. 1-7

11. Pull both drawer slides out and reassemble the drawer to the drawer slides with the two (2) Phillips head screws. (Fig. 1-8) Use of the two (2) dividers is optional. Close the drawer.

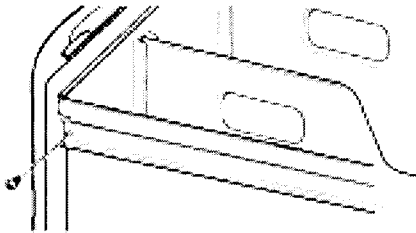

Fig. 1-8

SECTION 2

THEORY OF OPERATION

INTRODUCTION

The **HE³** and **HE^{3t}** Front-Loading Automatic Washers present a number of new features and operating characteristics quite different from previous models. In addition to the introduction of front-loading operation, the **HE³** and **HE^{3t}** contain a number of unique operating features designed to increase clothes cleaning ability while offering very high water and energy conservation.

Water System

The **HE³** and **HE^{3t}** water system consists of the hot and cold water inlet valves, a water temperature sensor, a water flowmeter and control and the dispenser distribution system along with a traditional pressure switch.

Water Inlet Valves -

The hot and cold water inlet valves are located at the back of the washer. These valves receive a control signal from the Central Control Unit to manage the temperature of incoming water. The temperatures are determined by the specific wash cycle selected and a temperature sensor located in the wash tub. To improve cleaning of heavily soiled clothing and to provide a sanitizing feature, the water temperature can be increased through the use of a heating element located in the bottom of the tub, (**HE^t** model only).

Flowmeter

Water flow, or the quantity of water introduced throughout any cycle is monitored by a flowmeter and Central Control Unit. When the flowmeter registers a maximum of 10.5 gal. (40 L), and the Central Control Unit has not detected the pressure switch trip, the water valves will be shut off and an error code will show in the digital display.

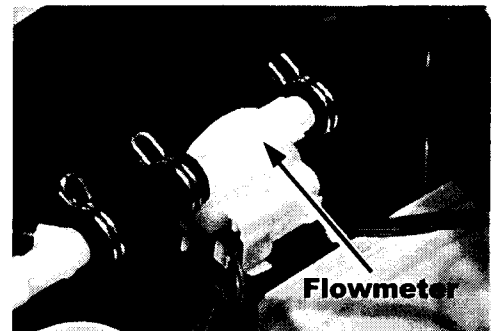

Fig. 2-1

Dispenser Distribution System

All wash and rinse water is introduced into the wash tub through a Dispenser Distribution System located in the top left corner of the washer. The system consists of a motor that turns a cam gear. The cam follower will divert the incoming water to one or more of the follow water inlet modes:

- Detergent Dispensing
- Bleach Dispensing
- Fabric Softener Dispensing
- Rinse Dispensing (no additives)

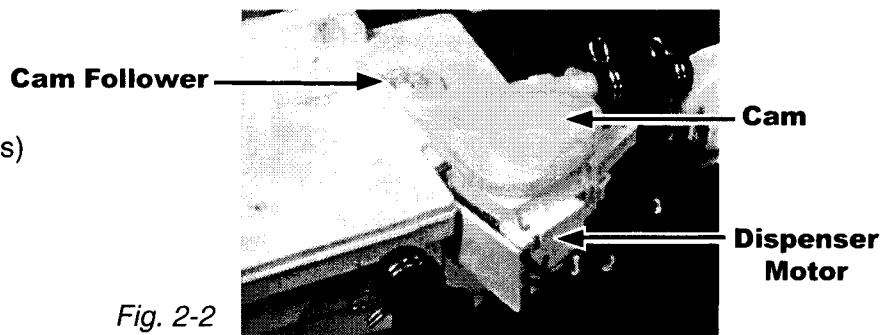

Fig. 2-2

The dispenser drawer has four separate compartments for adding laundry products to the wash load. These compartments are:

1. Prewash Detergent Compartment
2. Main Wash Detergent Compartment
3. Bleach Compartment
4. Fabric Softener Compartment

Laundry products are diluted and dispensed automatically at the proper time during the wash cycle.

The separator between the Prewash and Main Wash Detergent Compartments can be moved to accommodate either liquid or powdered detergents. (Fig. 2-4)

The drawer release lever (shown here is the normal position) can be installed in alternate position (A) to accommodate stacking a matching dryer on top of the washer. (Fig. 2-4)

Refer to Use and Care Guide for the Front-Loading Automatic washer (PN 4619 7020 3971) for proper use of laundry products.

There are two routes for the water to enter the wash tub. Most of the water flows through the dispenser assembly. A small portion of the water flow around the dispensers and is used to wash the door window.

1. Main Inlet Tube (Fig. 2-5, A)
2. Window Washer Inlet Tube (Fig. 2-5, B)

Air Vent System

As a safety feature, the washer is designed to allow fresh air to circulate through the tub. An inlet vent at the front of the washer console brings air into the tub through the dispenser assembly. (Fig. 2-6A) The air is vented out the back of the washer. (Fig. 2-6B)

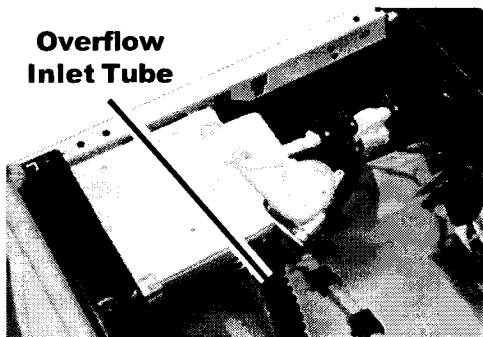

Fig. 2-6A

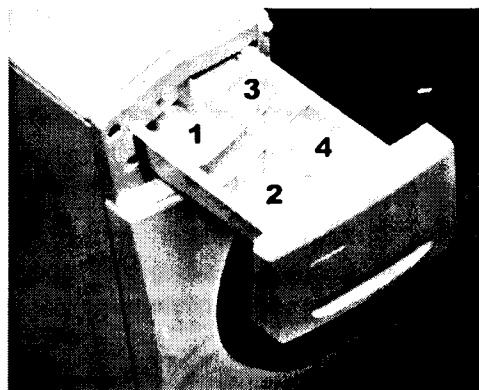

Fig. 2-3

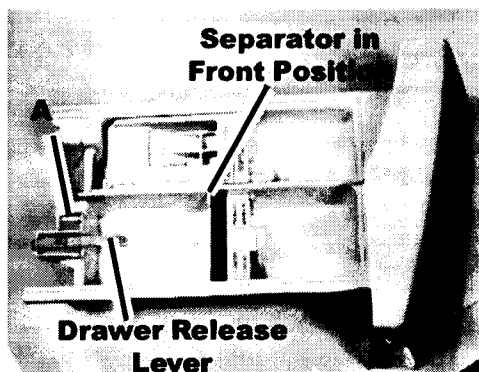

Fig. 2-4

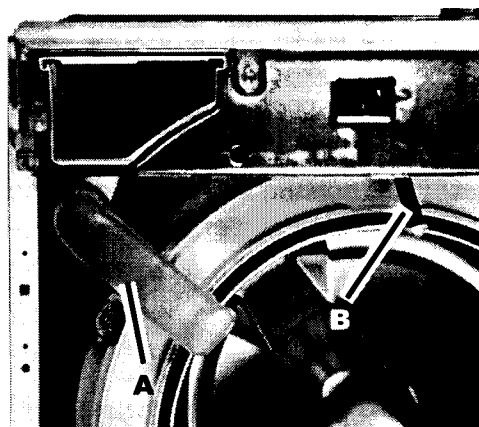

Fig. 2-5

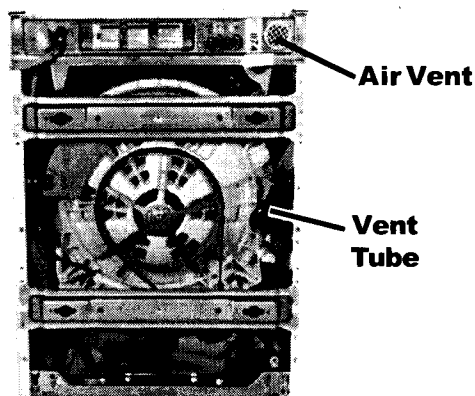

Fig. 2-6B

Pressure Switch

The pressure switch is located in the top right rear corner of the washer. (Fig. 2-7) This switch senses water level in the wash tub. The control signal from the pressure switch is sent to the Central Control Unit and is used to determine the amount of water introduced into the wash tub during the wash cycle.

The pressure switch also senses the suds level in the wash tub. If excessive sudsing occurs, the washer starts an automatic suds routine. The display will show the word SUDS. The automatic suds routine adds additional rinse and drain operations until the suds level is reduced.

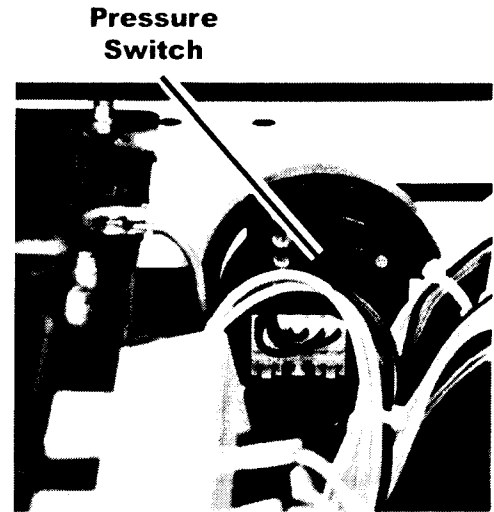

Fig. 2-7

Customer Interface and Cycle Selection

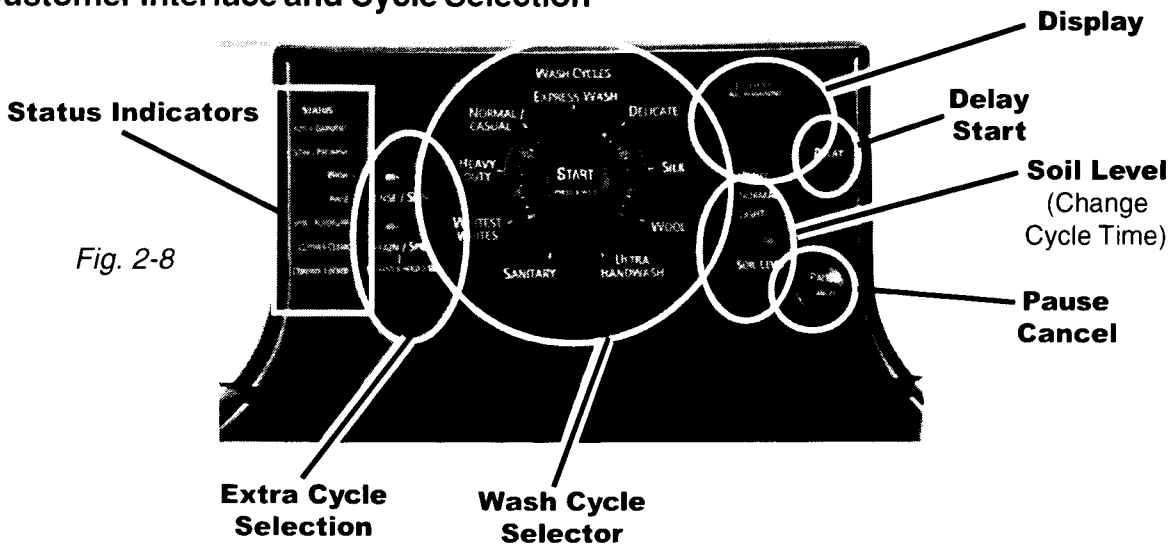

Fig. 2-8

Status Indicators - These lights show which portion of the cycle the washer is operating. They also indicate when additional items can be added to the wash cycle and when the controls are locked.

Extra Cycle Selection - The Rinse/Spin selection operates a rinse and spin cycle only. This cycle combines fast speed tumbling and extra high speed spin. The spin speed can be reduced by selecting a speed from the SPIN SPEED modifier.

Wash Cycle Selector - Choose a Wash Cycle by selecting the button next to the desired cycle. Each cycle is designed for different types of fabric and soil levels. (See Table 2-1, Page 2-4)

Display - The display provides such information as time remaining for selected wash cycle and error codes.

Delay Start - To start the washer at a later time, press the DELAY button until the desired delay start time (in hours) shows in the Display, then select START. The countdown to the start time will show in the display.

Soil Level - Pressing this button will change the length of the wash cycle. Heavy will add time to a normal wash cycle, light will shorten a normal wash cycle.

Pause/Cancel - Pressing this button will allow changing any option or changing a wash cycle after the wash cycle has begun. Press the PAUSE/CANCEL button, select the desired Option, press and hold the START button for one (1) second. To cancel a cycle and select a new one, press the PAUSE/CANCEL button, select the new cycle, select the desired options, press and hold the START button for one (1) second.

Option Selection

D = Default, X = Available, - = Not Available

Kenmore High

CYCLE NAMES	OPTIONS				SOIL LEVEL MODIFIERS				WATER TEMPERATURES				SPIN SPEEDS							SPIN PROFILE			
	Stain Treat	Prewash	Ex-Rinse	Extended Spin	Soak	More	Norm	Less	Tap C/C	W/C	W/W	H/C	Super H/C	Ech 1200	H 1000	M 800	L 600	Ex L 300	No Spn	Normal	Gentle	Ex-Gentle	
Main Cycles	X	X	X	X	X	X	X	X	X	X	X	X	X	X	X	X	X	X	X	X	X	X	X
Sanitary	X	X	X	X	X	X	X	X	X	X	X	X	X	X	X	X	X	X	X	X	X	X	X
Whitest Whites	X	X	X	X	X	X	X	X	X	X	X	X	X	X	X	X	X	X	X	X	X	X	X
Heavy Duty	X	X	X	X	X	X	X	X	X	X	X	X	X	X	X	X	X	X	X	X	X	X	X
Normal/Casual	X	X	X	X	X	X	X	X	X	X	X	X	X	X	X	X	X	X	X	X	X	X	X
Express Wash	X	X	X	X	X	X	X	X	X	X	X	X	X	X	X	X	X	X	X	X	X	X	X
Delicate	X	X	X	X	X	X	X	X	X	X	X	X	X	X	X	X	X	X	X	X	X	X	X
Silk	X	X	X	X	X	X	X	X	X	X	X	X	X	X	X	X	X	X	X	X	X	X	X
Wool	X	X	X	X	X	X	X	X	X	X	X	X	X	X	X	X	X	X	X	X	X	X	X
Ultra Hand Wash	X	X	X	X	X	X	X	X	X	X	X	X	X	X	X	X	X	X	X	X	X	X	X
Mini Cycles	X	X	X	X	X	X	X	X	X	X	X	X	X	X	X	X	X	X	X	X	X	X	X
Rinse/Spin	X	X	X	X	X	X	X	X	X	X	X	X	X	X	X	X	X	X	X	X	X	X	X
Drain / Spin	X	X	X	X	X	X	X	X	X	X	X	X	X	X	X	X	X	X	X	X	X	X	X
Auto Soak	X	X	X	X	X	X	X	X	X	X	X	X	X	X	X	X	X	X	X	X	X	X	X

Table 2-1

Kenmore Mid

CYCLE NAMES	SOIL LEVEL MODIFIERS				WATER TEMPERATURES				SPIN SPEEDS							SPIN PROFILE							
	Manual Prewash	Ex-Rinse	Spin	Extended Spin	More	Norm	Less	C/C	W/C	W/W	H/C	H 1000	M 800	L 600	Ex L 300	No Spn	Normal	Gentle	Ex-Gentle				
Main Cycles	X	X	X	X	X	X	X	X	X	X	X	X	X	X	X	X	X	X	X	X	X	X	
Whitest Whites	X	X	X	X	X	X	X	X	X	X	X	X	X	X	X	X	X	X	X	X	X	X	X
Heavy Duty	X	X	X	X	X	X	X	X	X	X	X	X	X	X	X	X	X	X	X	X	X	X	X
Normal/Casual	X	X	X	X	X	X	X	X	X	X	X	X	X	X	X	X	X	X	X	X	X	X	X
Delicate	X	X	X	X	X	X	X	X	X	X	X	X	X	X	X	X	X	X	X	X	X	X	X
Ultra Hand Wash	X	X	X	X	X	X	X	X	X	X	X	X	X	X	X	X	X	X	X	X	X	X	X
Mini Cycles	X	X	X	X	X	X	X	X	X	X	X	X	X	X	X	X	X	X	X	X	X	X	X
Rinse/Spin	X	X	X	X	X	X	X	X	X	X	X	X	X	X	X	X	X	X	X	X	X	X	X
Drain / Spin	X	X	X	X	X	X	X	X	X	X	X	X	X	X	X	X	X	X	X	X	X	X	X

Table 2-1

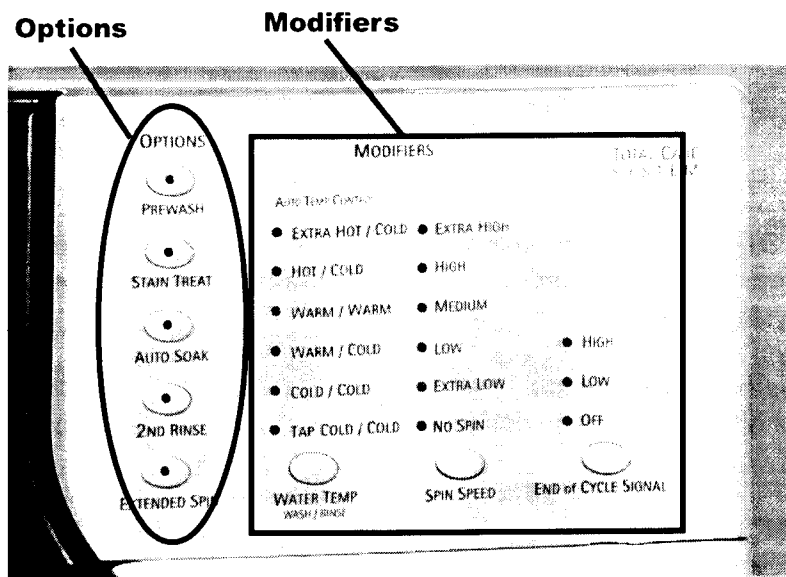

Fig. 2-9

Options

You can customize your wash by adding OPTIONS to your cycle selections. You can add or change an option after starting a cycle anytime before the selected option begins.

- See the “Laundry Guide” for an overview of possible options for each Wash Cycle selection.
- You can select more than one option for a cycle. Some options cannot be added to some cycles, for example, Stain Treat cannot be added to the Express Wash cycle.
- If an option is available with a selected cycle, the light for that option will glow when selected.
- If an option is unavailable with a selected cycle, there will be a short tone and the light for that option will **not** glow when selected.

Prewash

Use this option for heavily soiled loads that need pretreatment. This option adds a 15 minute prewash and drain to the main wash cycle.

- Add detergent to the Prewash and Main Wash compartments of the Dispenser Drawer.
- When using Prewash, do not use liquid detergent in the Main Wash compartment. Use powdered detergent for the main wash cycle.

NOTE: The Prewash and Auto Soak options cannot be selected in the same cycle.

Stain Treat

Use this option for heavily soiled loads that need improved stain treatment. When Stain Treat is selected, the water temperature of the selected wash cycle is automatically set to warm. The water will then be heated to a hot water temperature to aid in stain removal. This option will provide optimal removal of organic stains such as blood.

NOTE: If Stain Treat is selected with the Sanitary cycle, the water will be heated to a very hot temperature.

Auto Soak

Use the Auto Soak option for loads of heavily soiled cotton, linen, polyester or nylon with set-in stains. During Auto Soak, water will be added to the drum and the laundry will be equally distributed by a short tumbling phase. Laundry will then be soaked by phases without drum movement. After soaking, the washer drains without spinning.

Added to a Wash Cycle: A 30 minute soak time is added to the main wash cycle to improve removal of set-in stains.

1. Add detergent to both the Prewash and Main Wash compartments of the Dispenser Drawer.

NOTE: The Auto Soak and Prewash options cannot be selected in the same cycle. Use powdered detergent for the main wash cycle because liquid detergent will seep into the washer during Auto Soak.

2. Select a Wash Cycle.
3. Select AUTO SOAK.

NOTE: For cycles with hot wash temperatures, the soak temperature will be set to warm; otherwise, the soak temperature will be the same as the wash temperature.

4. Select and hold START (approximately 1 second). After soaking, the washer drains and the wash cycle starts.

Without a Wash Cycle: Provides a soak time with warm or cold water followed by drain.

1. Add detergent only to the Prewash compartment of the Dispenser Drawer.
2. Select DRAIN/SPIN or RINSE/SPIN first, then AUTO SOAK.
3. Choose the desired soak temperature.
4. Select and hold START (approximately 1 second).

2nd Rinse

A second rinse can be used to ensure the removal of detergent or bleach residue from garments. This option provides an additional rinse with the same water temperature as the first rinse.

Extended Spin

Use this option to add an additional spin to any cycle to improve the “fluff” of your laundry, to reduce drying time, and to save energy.

Modifiers

Preset cycle settings of Water Temperature, Wash/Rinse, and Spin Speed can be changed. You can change a modifier after starting a cycle anytime before the selected modifier begins.

Touch Pad/LED Assembly

Touchpad/LED Assembly

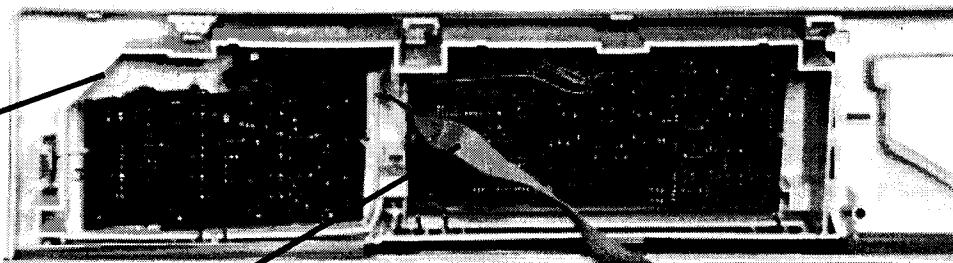

Ribbon Cable

Fig. 2-10

The Touch Pad/LED Assembly, (Fig. 2-10), is a single assembly and is connected to the Central Control Unit by a ribbon cable. This assembly contains all of the buttons, LEDs and ribbon cable and printed circuit boards for the user to operate the washer. The interfaces the consumer inputs to the Central Control Unit.

- To change the water temperature, select the WATER TEMP button until the desired setting glows.
- To change the spin speed, select the SPIN SPEED button until the desired setting glows.
- To change the loudness of the End of Cycle Signal, select END of CYCLE SIGNAL.

Wash/Rinse Temp

Select a water temperature based on the type of load you are washing. Use the warmest water safe for fabrics. Follow garment label instructions.

Warm rinses leave the loads dryer than cold rinses. Warm rinses increase wrinkling. In cold climates, a warm rinse makes the load more comfortable to handle. Cold rinses save energy.

Auto Temp Control

ATC (Auto Temp Control) electronically senses and maintains a uniform water temperature. ATC regulates incoming hot and cold water. The ATC is automatically turned ON when a cycle is selected.

- ATC ensures consistent cleaning.
- ATC works for the wash temperature with Extra Hot/Cold, Hot/Cold, Warm/Warm, Warm/Cold, and Cold/Cold settings.
- The Cold rinse temperatures depend on the cold water at the tap.
- For the Tap Cold/Cold setting, both wash and rinse temperatures depend on the cold water at the tap.
- The Warm rinse setting regulates the water temperature at approximately 104°F (40°C).

Central Control Unit (CCU)

The Central Control Unit is located at the top rear of the washer and is enclosed in a control box. (Fig. 2-11) There are no serviceable parts inside the control box. If diagnostic tests indicate any component of the CCU is defective, the entire control box must be replaced.

The CCU receives input from the touchpad/LED assembly and directly controls the dispenser, drain pump, water inlet valves, door locking and unlocking solenoids, and heating element relay. The CCU monitors the pressure switch, flow-meter, temperature sensor and door lock switches.

The CCU sends the customer selection input to the Motor Control Unit for proper motor operation.

Motor Control Unit (MCU)

The Motor Control Unit is located inside a plastic control box located in the lower front corner of the washer cabinet. (Fig. 2-12) The control box is shown with the access door open.

The MCU operates the drive motor at varying speeds and direction based on inputs received by the CCU to complete the cycle selected. The MCU also monitors a tachometer on the motor to confirm that the drive motor is operating at the proper speed and direction.

Drive Motor

The drive motor is a three-phase asynchronous induction type that operates at various speeds and direction based on input voltages and frequencies. A tachometer on the motor shaft sends a feedback signal to the Motor Control Unit indicating the rotation speed and direction.

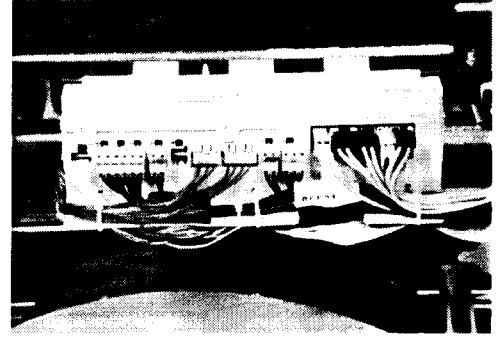

Fig. 2-11



Fig. 2-12

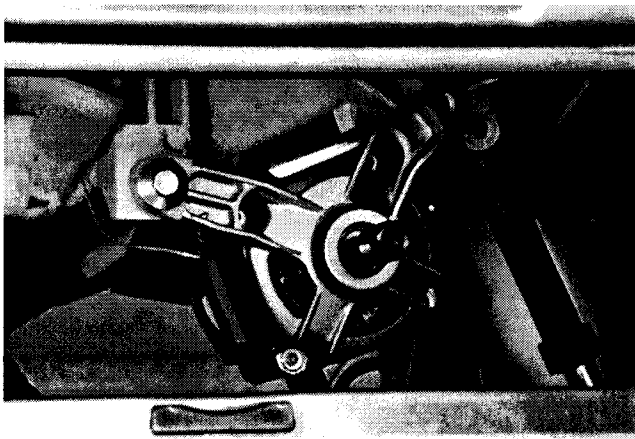

Fig. 2-13

Pump Motor

A separate pump/pump motor is used to drain the wash tub. (Fig. 2-14) The pump motor is 120 VAC and is attached directly to the pump. The pump has a clean-out filter located at the front that allows for the removal of large objects that may have passed from the drum. (Fig. 2-15)

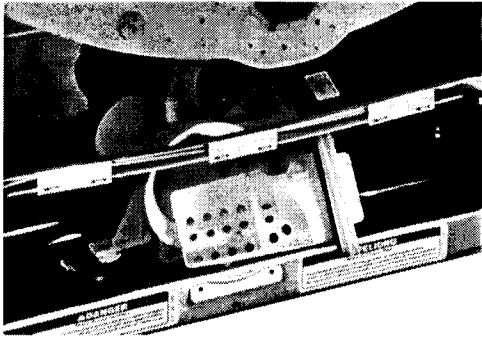

Fig. 2-15

Eco Valve

The washer has a specially designed valve that closes during the wash portion of the cycle so that 100% of the water and detergent mixture is used on the wash load. The Eco Valve insures that no water or detergent is wasted. (Fig. 2-14 & 2-16)

Suspension System

The wash tub is held in its horizontal position with four pneumatic shock absorbers attached to the bottom four corners of the tub assembly. In addition, the wash tub is suspended from the top frame of the washer with two springs attached to the sides of the unit.

Stability for this suspension system is provided by three concrete counter weights. Two are located at the front of the wash tub. One is positioned at the back of the tub. These counter weights eliminate the need for the traditional balance ring. (Fig. 2-17)

Drain Pump

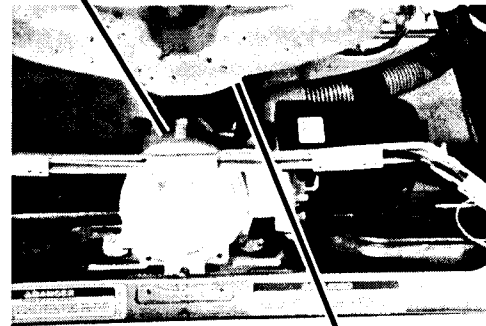

Fig. 2-14

Eco Valve

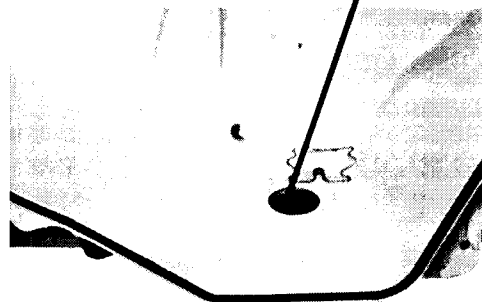

Fig. 2-16

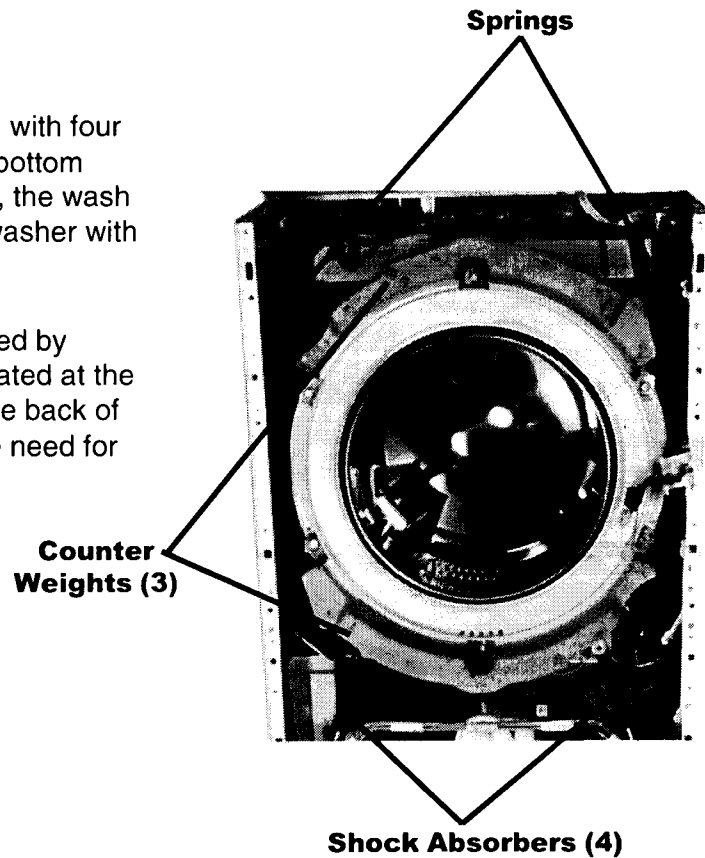

Fig. 2-17

Heating Element and Temperature Sensor

Model *HEst* provides a heating element to increase the water temperature during certain wash cycles. The temperature sensor is used with the heater to monitor water temperature in the tub. (Fig. 2-18)

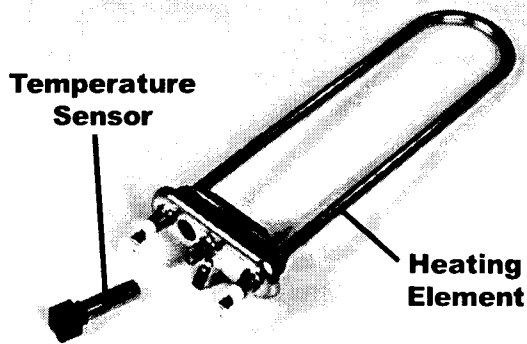

Fig. 2-18

Door Lock/Switch Assembly

The Door lock/Switch Assembly is located on the right side of the door opening. (Fig. 2-19 & 2-20) The assembly contains a latching mechanism that will electrically lock the door during certain operations in a wash cycle.

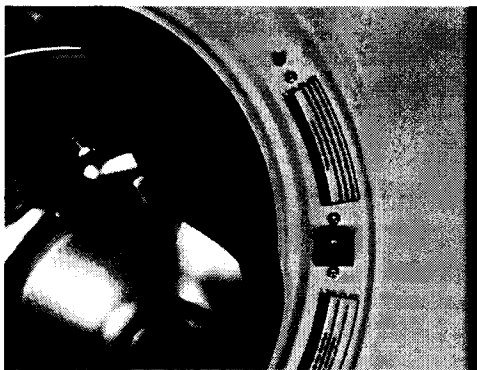

Fig. 2-19

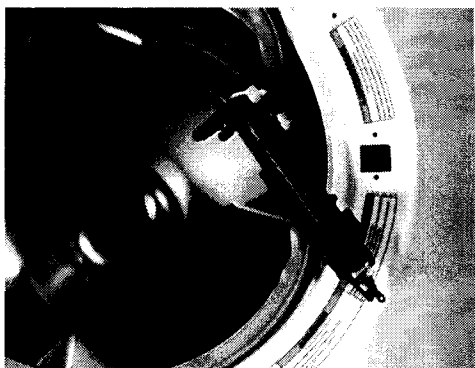

Fig. 2-20

Heating Element Relay

A relay is used to turn the heating element on and off. The heating element relay is located in the lower right-hand side of the washer cabinet. (Fig. 2-21) The CCU operates a solenoid to close the main relay contacts, providing 120 VAC to the heating element.

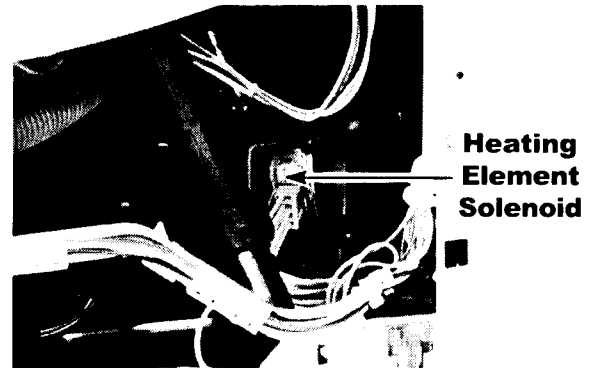

Fig. 2-21

Panel Interlock Switches

The front and rear interlock switches (Fig. 2-22) are located immediately behind the toe and rear panels of the washer. The switches provide a grounding circuit to the drive motor and heating element, when either panel is removed for servicing.

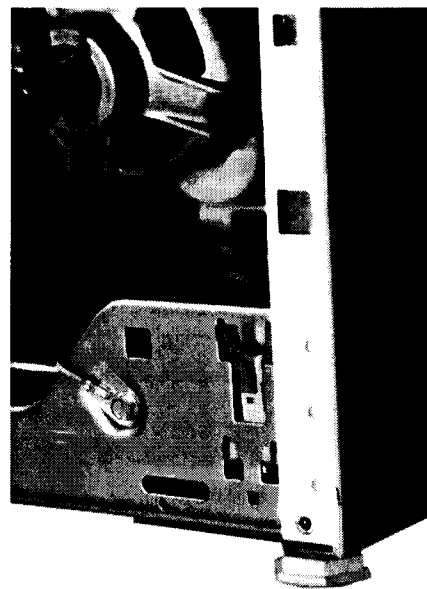
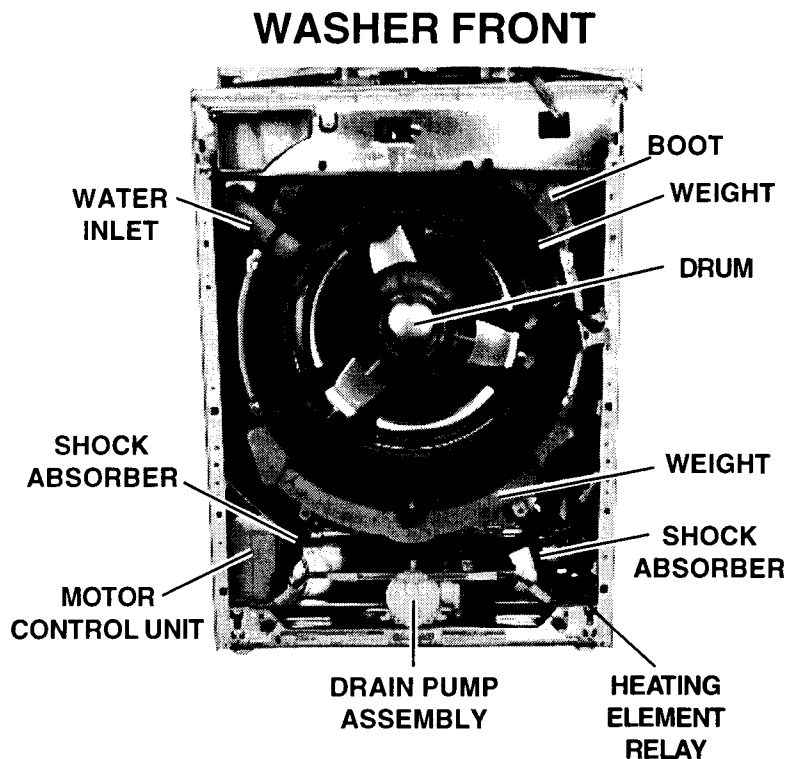
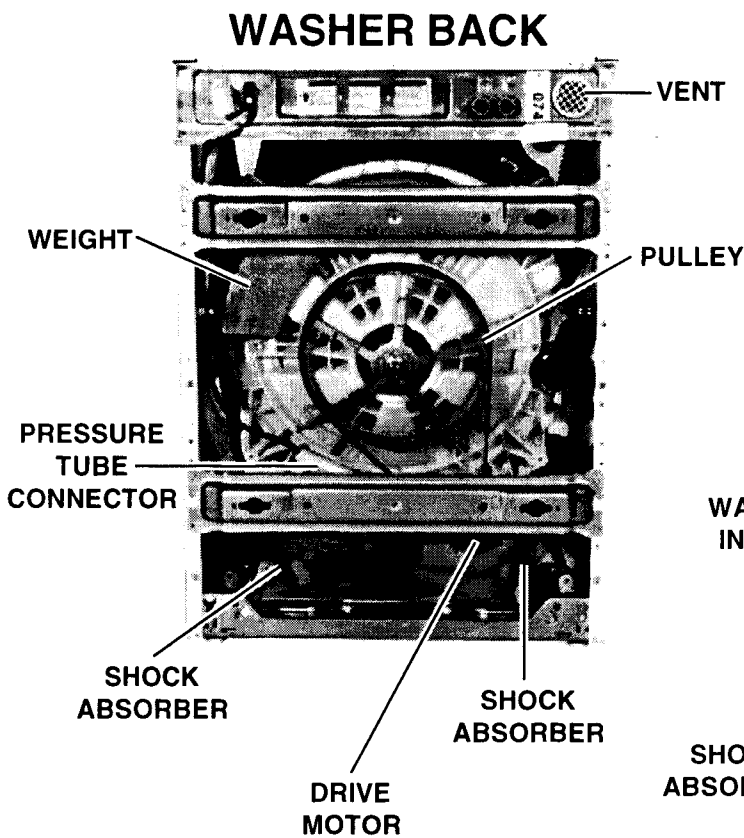
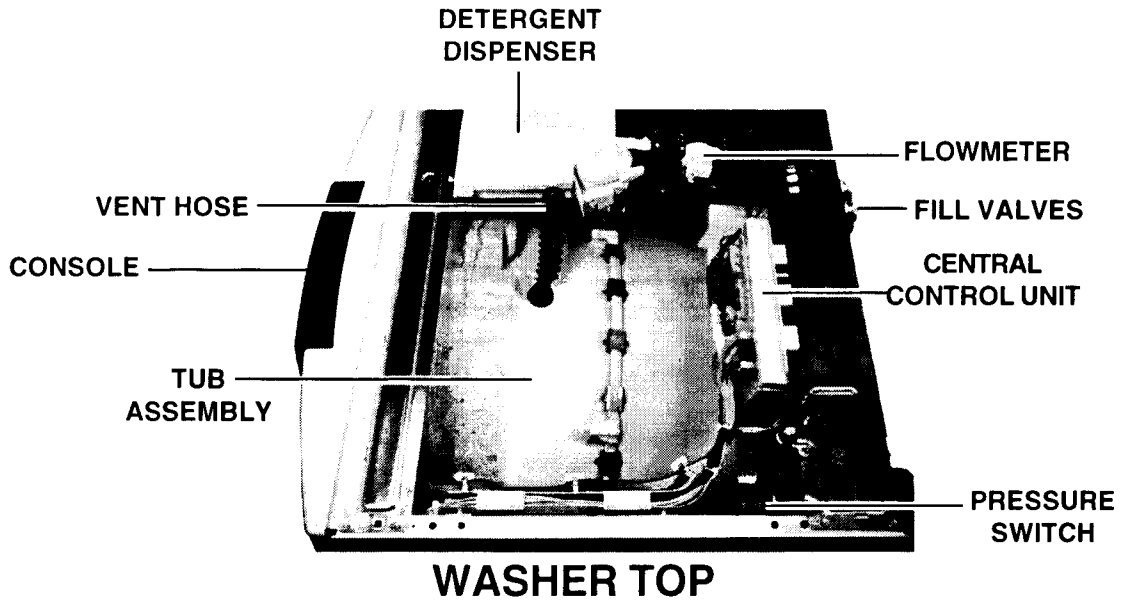

Fig. 2-22

Section Three

COMPONENT ACCESS

COMPONENT LOCATION



COMPONENT ACCESS

Required Tools

The Source 110 Front Loading Washer requires the use of Metric Socket Wrenches of various sizes, Torx T-15, T-20 and T-25 Drivers, a Crescent Wrench, a flat bladed screwdriver and a hammer.

ACCESSING COMPONENTS IN THE CONSOLE

Components accessible in the Console include the Console Cover and the Touch Pad/LED Assembly. Access to these components requires that the top of the washer be removed.

Removing the Washer Top

Three screws secure the washer top at the back of the washer. Remove the three screws and lift the top from the washer. (Fig. 3-4)



Fig. 3-4

Removing the Console from the Cabinet

Disconnect the Touch Pad/LED Assembly ribbon connector from the left side of the Central Control Unit (Fig. 3-5) and release it from the wiring harness brackets on the right side of the washer top.

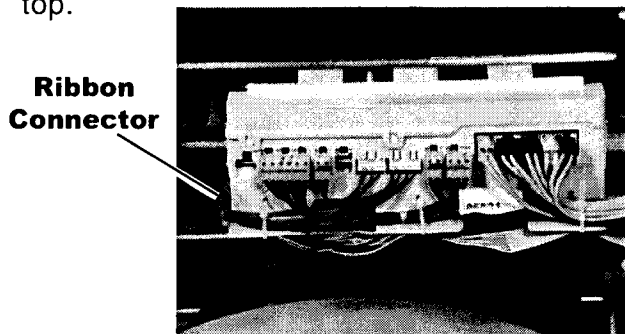

Fig. 3-5

Remove the detergent dispenser drawer by pressing down on the release tab at the back of the drawer (Fig. 3-6) and pulling it completely out of the washer.

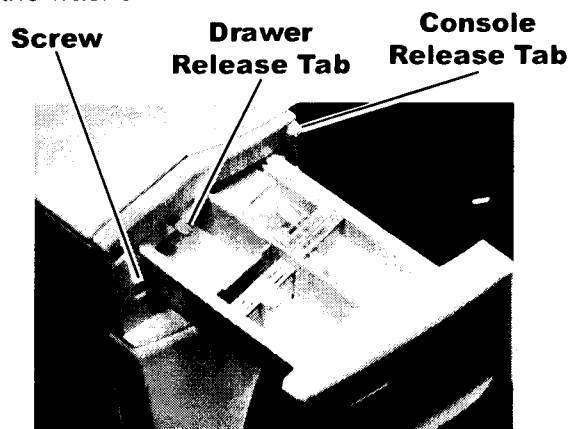

Fig. 3-6

Once the drawer is removed, remove the screw in the recessed hole next to the drawer opening. Release the tab securing the right side of the console to the washer and remove the console. Be sure the ribbon cable clears the cabinet frame.

Removing the Touch Pad/LED Assembly from the Console

The Touch Pad/LED Assembly is a single unit and contains the Push Buttons, LEDs, cable, etc. Replace the entire assembly if any components are defective.

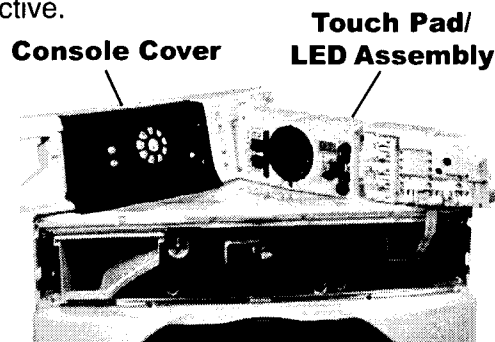

Fig. 3-7

There are nine tabs securing the Touch Pad/LED Assembly to the console. (Fig. 3-9) A flat bladed screwdriver will be helpful in releasing these tabs.

Typical Release Tab

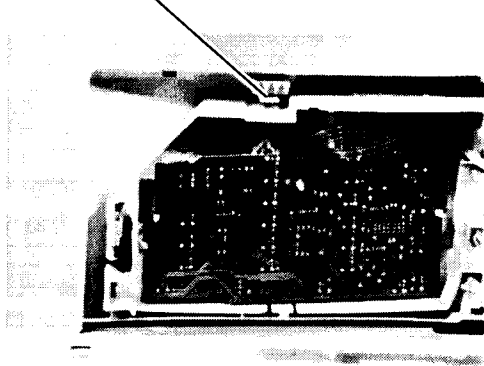

Fig. 3-8

Release these tabs in sequence from left to right around the Touch Pad/LED Assembly until all of the tabs are free and the Assembly can be lifted from the console. (Fig. 3-9)

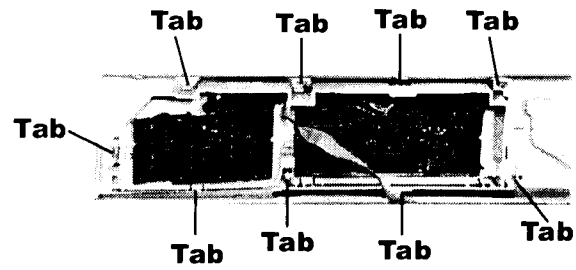

Fig. 3-9

REMOVING THE WASHER DOOR AND DOOR SWITCH

The washer door can be removed by removing the two screws securing the door hinge to the washer front and lifting upward.

Screws

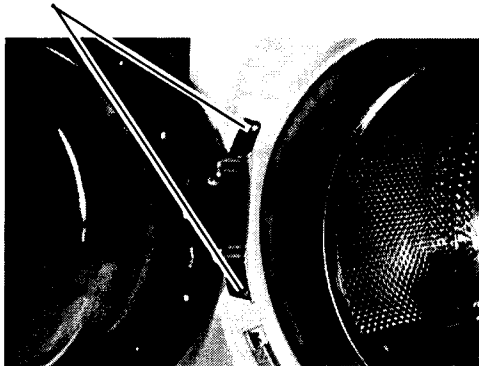

Fig. 3-10

Ease the edge of the boot off of the lip of the washer front near the door switch. (Fig. 3-12) Remove enough of the boot to gain access to the door switch behind the washer front panel.

Boot Pulled Back

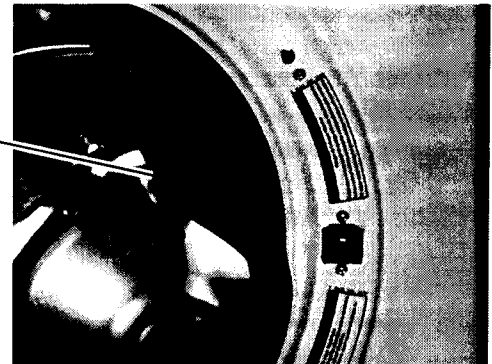
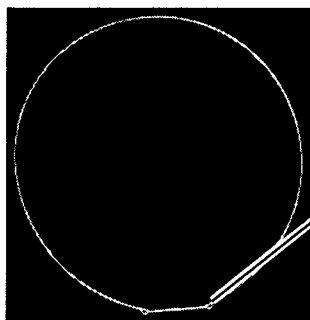

Fig. 3-12

Access to the door switch requires that the water seal boot be removed from the front of the washer. (Fig. 3-11) Use a flat bladed screwdriver at the location of the retainer spring and pull the retainer forward and then off the perimeter of the boot.



Retainer Spring

Fig. 3-11

The door switch is secured to the washer front panel with three screws. Once these screws are removed, the door switch will remain in place until it is lifted slightly and pulled back from the washer front panel.

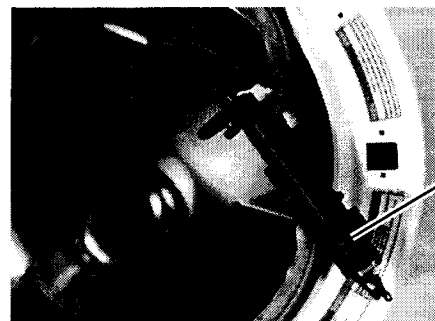

Door Switch Assembly

Fig. 3-13

REMOVING THE WASHER FRONT PANEL

Removing the washer front panel will require that the door switch be removed and the boot be separated completely from the front panel opening. The console must also be removed.

Next, remove the three screws securing the toe panel to the front of the washer (Fig. 3-14) and remove the toe panel by lifting slightly and pulling forward.

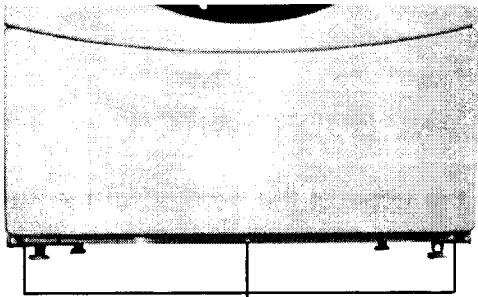

Screws
Fig. 3-14

Remove the two screws securing the bottom of the front panel to the washer, and the two screws securing the top of the front panel to the washer. The front panel can now be removed from the washer. (Fig. 3-15)

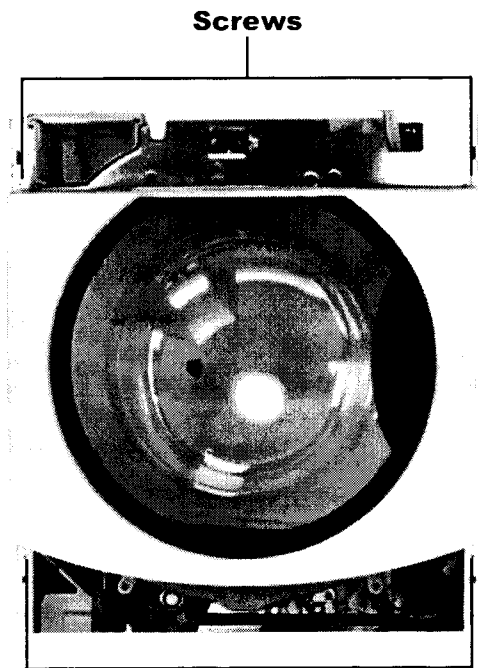

Screws
Fig. 3-15

REMOVING THE BOOT FROM THE TUB ASSEMBLY

The boot can be completely removed from the outer rim of the tub assembly.

Carefully pull the boot from around the water inlet and window washer tubes. Remove the boot retainer clamp by loosening the clamp screw located at the upper right of the tub opening. The boot can now be removed from the tub.

REPLACING THE BOOT AND DOOR SWITCH

When replacing the boot and washer front panel, special care must be taken to assure a proper water seal and operation.

Carefully pull the nozzle from the window washer tube. Separate the plastic gasket ring from the nozzle. Insert the nozzle through the hole in the boot and slide the plastic gasket ring down the shaft of the nozzle so that the boot is securely trapped between the gasket ring and the nozzle ridge. Insert the nozzle shaft into the window washer inlet tube and insert the end of the water inlet tube into the boot.

Fit the boot around the front lip of the tub so it rests smoothly and evenly. Fit the boot clamp around the front lip of the tub and tighten the screw. Be careful not to over tighten this screw. Damage to the boot clamp or the boot could occur.

When reinstalling the door switch, be sure to insert the two tabs on the right side of the switch assembly into the slots in the plastic wiring harness guide. Failure to do this will result in unwanted noise while the machine operates.

REMOVING THE DETERGENT DISPENSER ASSEMBLY

The Detergent Dispenser Assembly is located under the washer top. Begin by removing the washer top, console and front panel.

Separate the water inlet and window washer tube from the boot.

Pull the water inlet tube from the outlet connector of the detergent dispenser. (Fig. 3-16)

NOTE: When reinstalling the water inlet tube, wet the water inlet gasket on the detergent dispenser with water only. Do not use any other lubricant. Align the locator nib on the water inlet tube with the indentation on the dispenser connector and slide the tube onto the detergent dispenser assembly.

Remove the screw securing the front of the detergent dispenser assembly to the top front frame member. (Fig. 3-16)

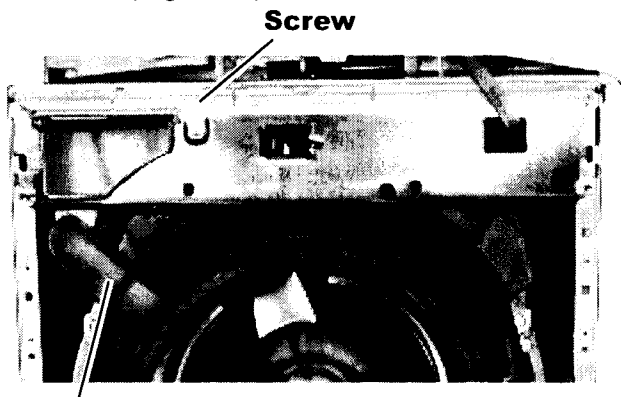

Water Inlet Tube

Fig. 3-16

Disconnect the overflow hose from the detergent dispenser assembly. (Fig. 3-17)

Remove the screw securing the detergent dispenser assembly to the top left frame member. (Fig. 3-17) Slide the assembly back slightly and lift the assembly out.

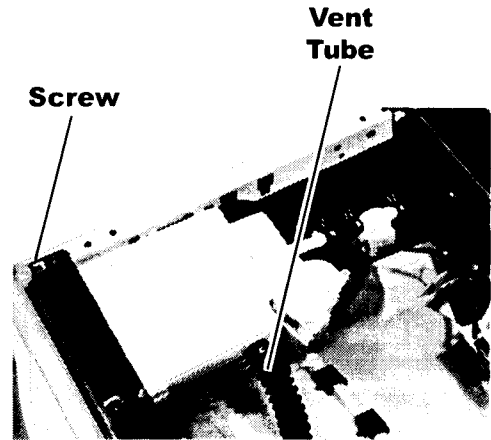

Fig. 3-17

To remove the detergent dispenser motor assembly, lift the cam follower from the diverter cam and rotate the diverter cam clockwise to access the motor mounting screws.

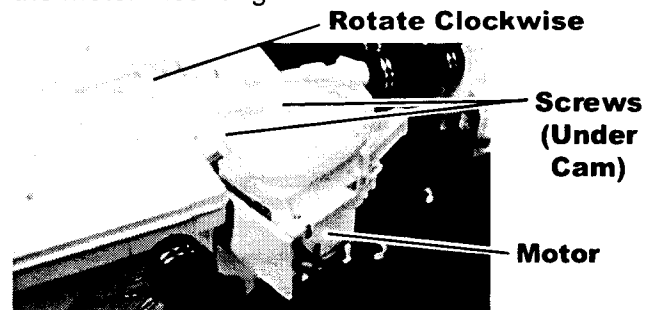

Fig. 3-18

REMOVING THE MAIN CONTROL BOX AND PRESSURE SWITCH

The main control box is a single assembly and does not contain any serviceable parts. It can be removed by lifting the top plastic tabs securing it to the back cabinet frame and sliding it towards the front of the washer. (Fig. 3-19)

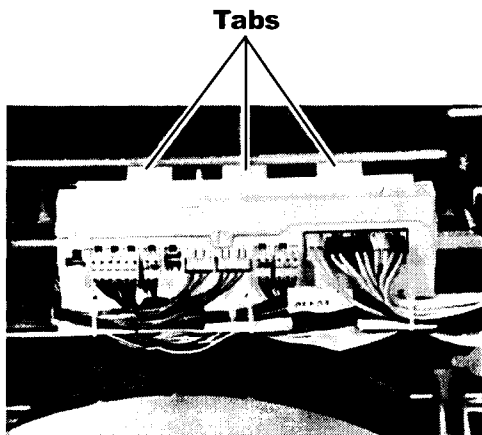
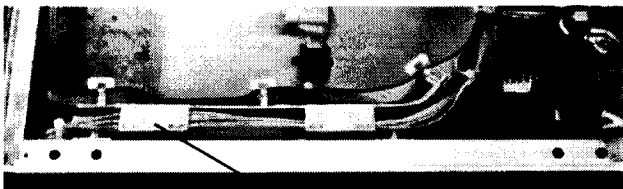

Fig. 3-19

To remove the pressure switch, first remove the wiring harness retainer from the side of the cabinet. (Fig. 3-20)



Wiring Harness Retainer

Fig. 3-20

Then disconnect the wiring harness connectors and the pressure hose and turn the pressure switch counterclockwise to release it from the cabinet. (Fig. 3-21)

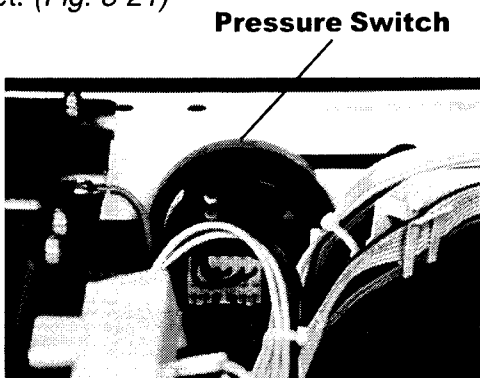

Fig. 3-21

REMOVING THE DRIVE MOTOR

The drive motor can be removed once the back panel has been removed.

Twelve screws secure the back panel to the washer. Remove the 12 screws and remove the back panel. Remove the Drive Belt.

Disconnect the wiring harness connectors and ground wires from the drive motor terminals. Push the wiring harness tie from the motor mounting bracket.

Remove the mounting bolt securing the motor to the tub. (Fig. 3-22)

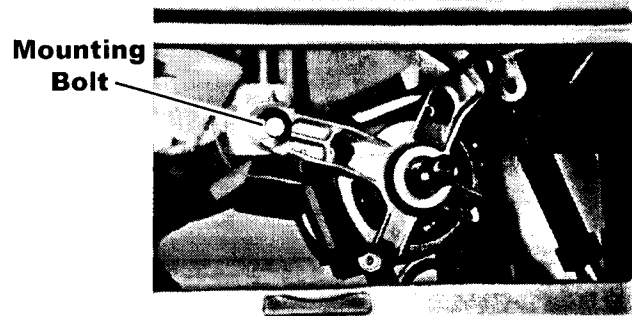

Fig. 3-22

REMOVING THE PUMP ASSEMBLY

The pump assembly can be accessed once the toe panel has been removed.

To clean out the large item filter, turn the large knob counterclockwise and pull it out. (Fig. 3-23)

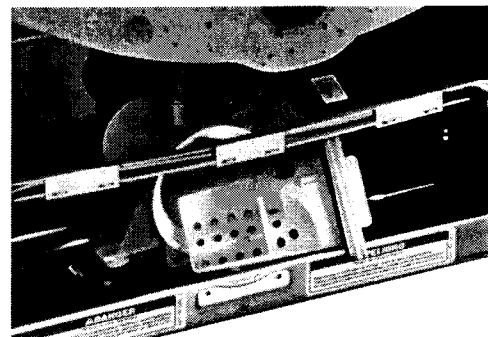

Fig. 3-23

To remove the pump assembly, begin by opening the door covering the wiring harness connector and disconnect the wiring harness from the pump motor terminals. Remove the screw securing the pump assembly to the washer frame. (Fig. 3-24) Once the pump is removed the drain hose and tube outlet hose can be removed.

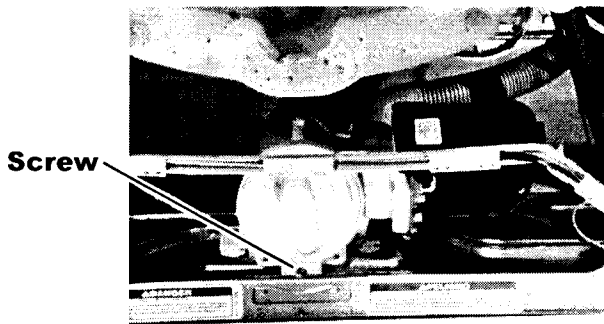
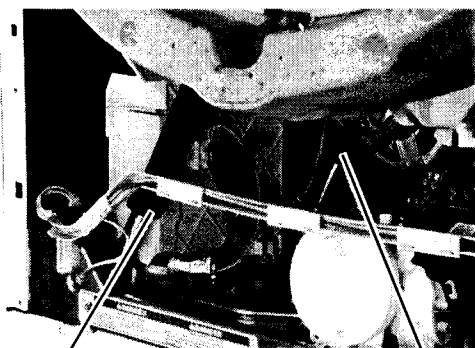

Fig. 3-24

REMOVING THE SHOCK ABSORBERS

The tub is held in position by four shock absorbers, two in front (Fig. 3-25) and two at the back. Each shock absorber can be disconnected from the tub by turning the top of the shock mount counter clockwise, 90°. The shock can be removed from the washer by turning the bottom shock mount counterclockwise, 90°.



Front Shock Absorbers

Rear Shock Absorbers

Fig. 3-25

ACCESSING THE MOTOR CONTROL UNIT

Access to the Motor Control Unit may require removing the left front shock absorber. Using a flat bladed screwdriver, lift up on the plastic tab under the front right corner of the motor controller box. (Fig. 3-26 - INSET)

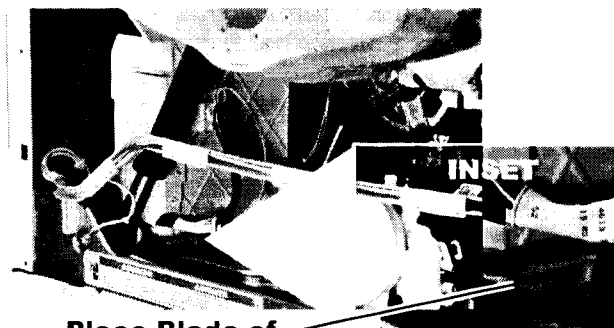

Place Blade of Screwdriver Here

Fig. 3-26

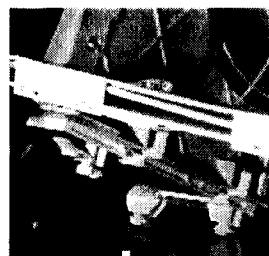

Slide the box forward to release the two tabs at the back of the box from the bottom panel of the washer. (Fig. 3-27)

Fig. 3-27

Open the door on the control box to access to the test points of the Motor Control Unit. (Fig. 3-28)

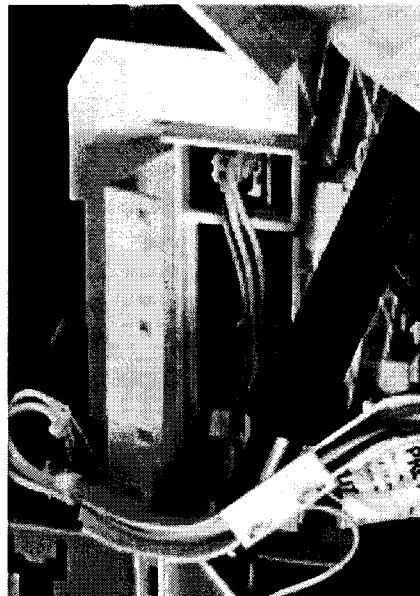
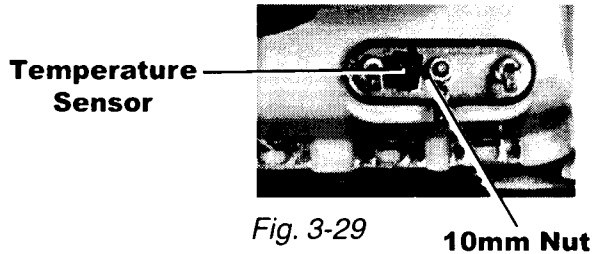

Fig. 3-28

REMOVING THE HEATING ELEMENT AND TEMPERATURE SENSOR

Disconnect the wiring harness connectors from the heating element terminals and loosen but do not remove the 10-millimeter nut between the heating element terminals. (Fig. 3-29) Then slide the heating element from the tub. Slide the temperature sensor from the heating element bracket.



REMOVING THE TUB AND DRUM ASSEMBLY

There are three concrete weights attached to the tub assembly. All three must be removed for safe removal of the tub assembly.

Access to the weight on the top front of the tub requires removing the six screws securing the top front frame member from the washer and removing the frame member. (Fig. 3-30A)

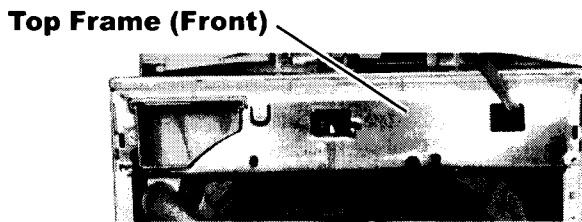

Access to the weight on the top back of the tub requires removing the two screws securing the top frame member to the washer and removing the frame member. (Fig. 3-30B)

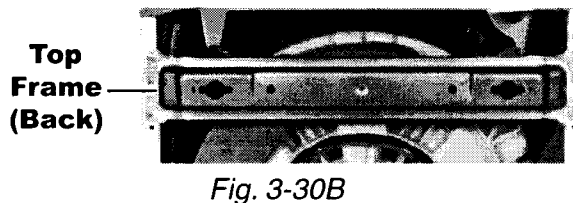

Each weight is secured to the tub by three 13-millimeter bolts. (Fig. 3-31) Remove the three bolts and lift the weight from the tub.

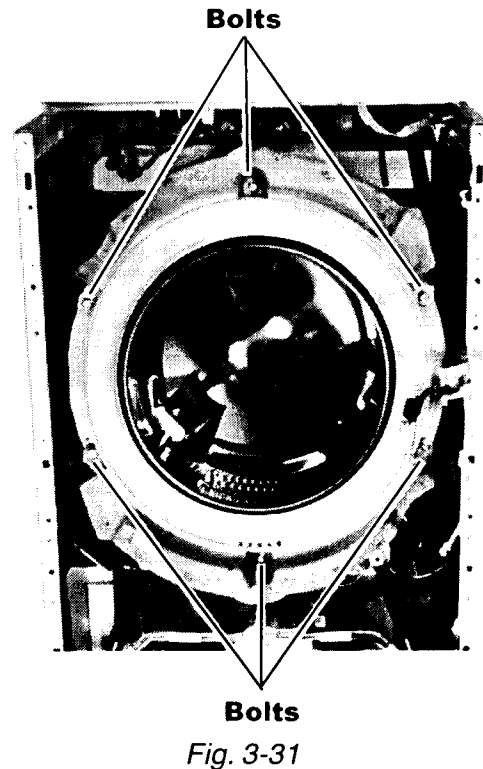

Remove the flat nuts from the tub for safekeeping. (Fig. 3-32)

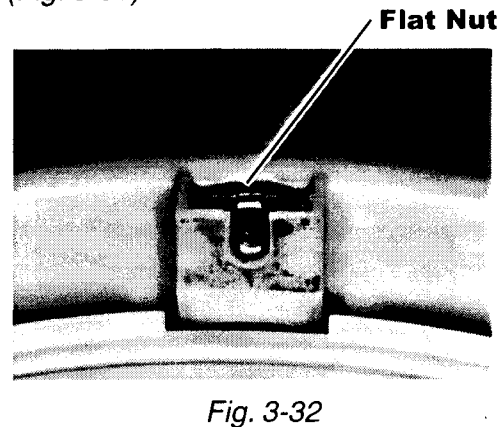

The tub is held in position by four shock absorbers, two in front (Fig. 3-33) and two at the back. (Fig. 3-34) Each shock absorber can be disconnected from the tub by turning the top of the shock mount counter clockwise, 90°. The shock can be removed from the washer by turning the bottom shock mount counterclockwise, 90°.

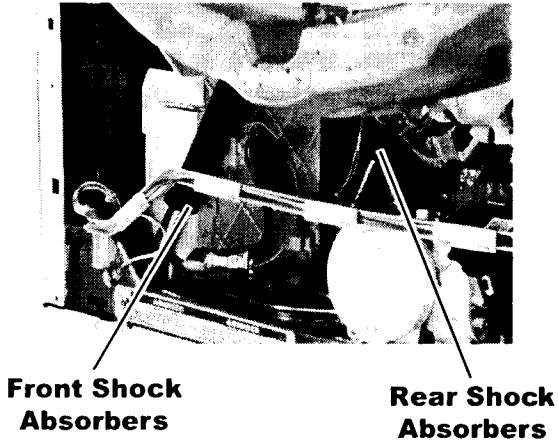

Fig. 3-33

At the back of the tub assembly, remove the belt from the drum and motor pulleys. (Fig. 3-34 -1)

To remove the pulley from the drum, place the handle of a crescent wrench through the pulley and into the steel bearing hub to keep the pulley from turning. (Fig. 3-34 -2)

Use a 21-millimeter socket wrench to remove the nut securing the pulley to the drum. (Fig. 3-34 -3)

Disconnect the ground wire from the bearing hub with a T-25 Torx driver. (Fig. 3-34 -4)

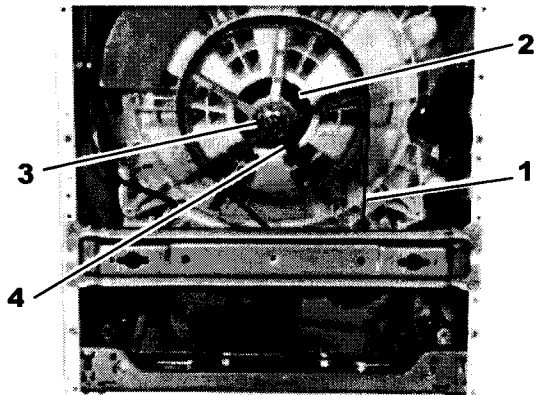
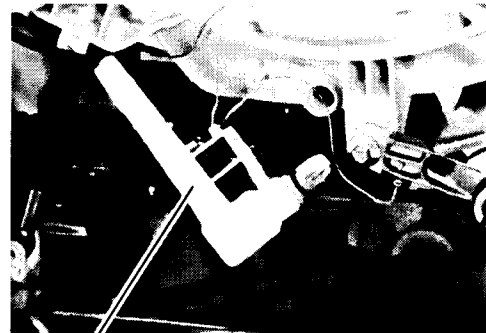

Fig. 3-34

Remove the screw securing the left end of the pressure tube connector to the tub. Then, press down on the plastic tab securing the right end of the pressure tube connector and pull it from the tub. (Fig. 3-35)



Pressure Tube Connector Removed

Fig. 3-35

Disconnect the vent hose and outlet hose from the tub.

Remove the top end of the suspension springs from the hanger slot in the top cabinet frame. To release the spring at the right side of the cabinet, it may be necessary to remove the wiring harness retainer from the cabinet.

Once the final spring is released the tub is free to be removed from the washer cabinet. (Fig. 3-36)

NOTE: Take care not to let the tub drop free inside the cabinet. This could result in damage to components in the cabinet or damage to the tub assembly.

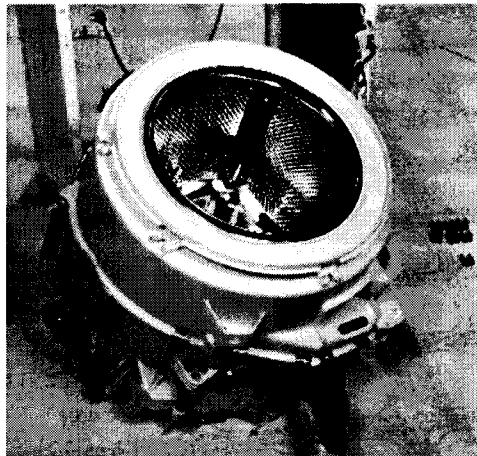

Fig. 3-36

The two piece tub is held together with a number of metal clamps which can be removed by prying them off with a flat bladed screwdriver. (Fig. 3-37)

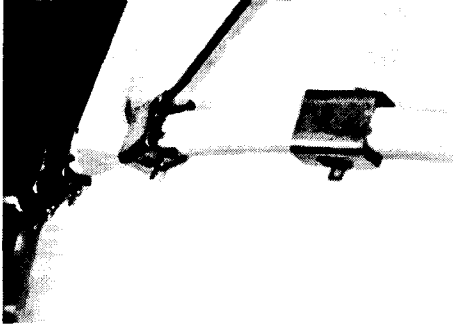

Fig. 3-37

The tub can now be separated and the drum can be pulled from the back half of the tub. (Fig. 3-38)

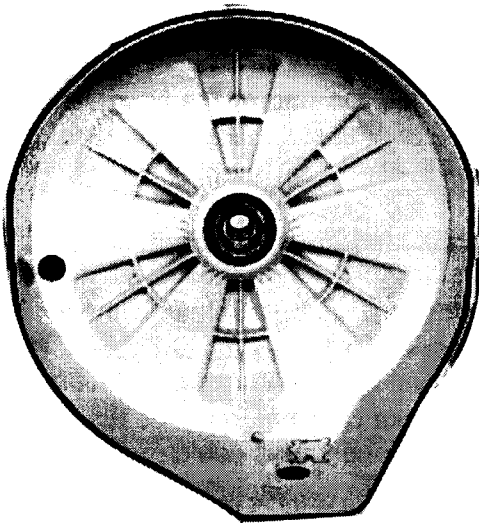

Fig. 3-38

REASSEMBLING AND REINSTALLING THE TUB ASSEMBLY

When reassembling and reinstalling the tub assembly, take note of these special procedures.

1. When reassembling the tub, be sure to install all the metal clips all around the tub. A hammer may be necessary to do this.
2. When reinstalling the heater element, be sure it is inserted properly in the retainer inside the tub. (Fig. 3-39)

Heater Clip

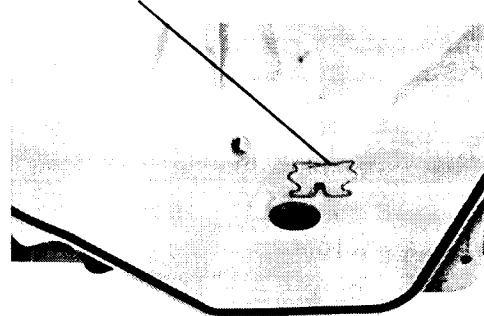

Fig. 3-39

3. When reinstalling the tub, be sure to hook the springs into the holes towards the front of the tub.
4. A small piece of duct tape may be necessary to hold the flat nut in place when replacing the front bottom concrete weight. (Fig. 3-40)

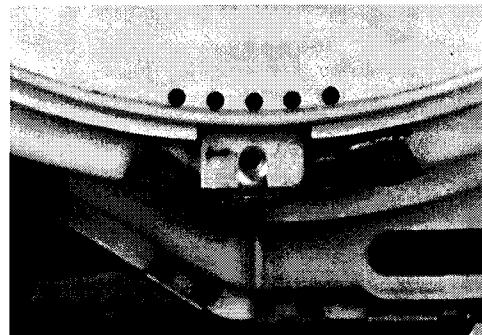
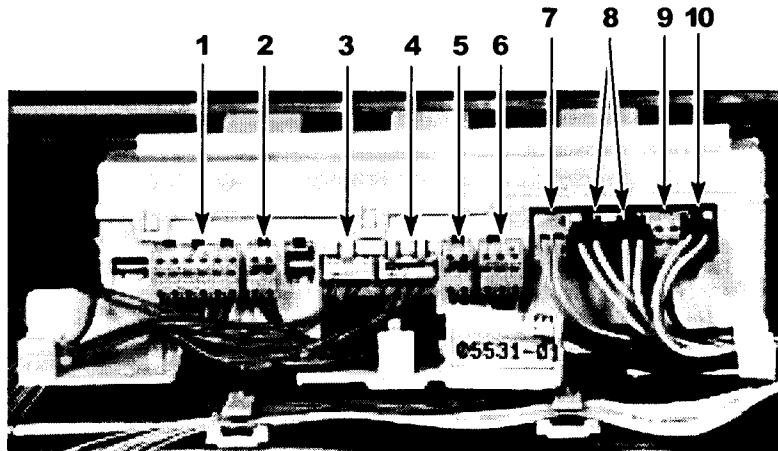

Fig. 3-40

Section Four COMPONENT TESTING

CENTRAL CONTROL UNIT

Connector Location



- | | |
|---------------------------|-----------------------------|
| 1. Pressure Switch | 6. Door Lock Solenoids |
| 2. Temperature Sensor | 7. Motor Control Unit Power |
| 3. Dispenser Switch/Motor | 8. Door Lock Main Switches |
| 4. Inlet Valves | 9. Heating Element Relay |
| 5. Drain Pump | 10. Line Filter |

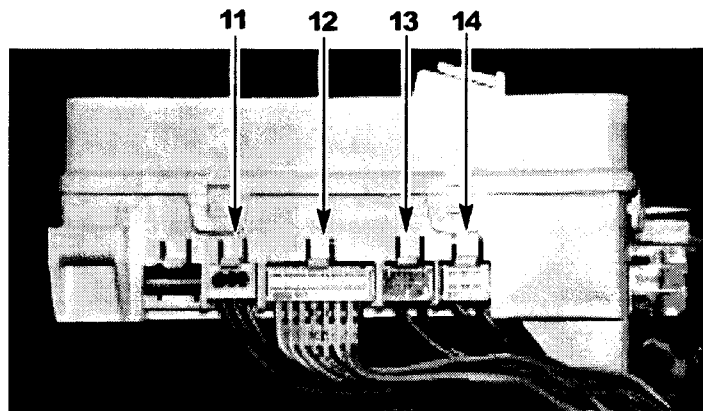

- 11. Serial Comm Link
- 12. Touchpad/LED Ribbon Cable
- 13. Door Switch
- 14. Flowmeter

! WARNING



ELECTRICAL SHOCK HAZARD

Disconnect power before servicing.

Replace all panels before operating.

Failure to do so can result in death or electrical shock.

COMPONENT CHECKS

Continuity checks can be made on various components of the washer from the connectors on the Central Control Unit. Before performing any of these tests, disconnect the washer from the wall outlet. In addition, disconnect the wiring harness connector from the Central Control Unit before making any continuity tests.

Pressure Switch

The pressure switch can be checked at various water levels. Disconnect the pressure switch connector from the control box.

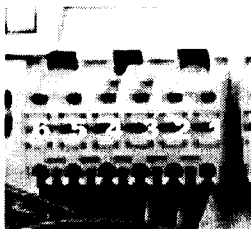

Water Level

Empty
Suds Detect
L1
Overflow

Test Points

4 to 6
1 to 2
4 to 5
3 to 4

Reading

0 ohms
0 ohms
0 ohms
0 ohms

Temperature Sensor



Temperature	Results
32° F (0° C)	35.9K Ω
86 ° F (30° C)	9.7K Ω
104° F (40° C)	6.6K Ω
122° F (50° C)	4.6K Ω
140° F (60° C)	3.2K Ω
158° F (70° C)	2.3K Ω
203° F (95° C)	1K Ω

Dispenser Switch and Motor



	Test Points	Reading
Switch	6 to 5	0 ohms
Motor	3 to 1	1400 ohms

Water Inlet Solenoids



Hot Water Solenoid
Cold Water Solenoid

Test Points

7 to 5
3 to 1

Reading

800 ohms
800 ohms

Drain Pump Motor



Test Points

2 to 1

Reading

15 ohms

Door Lock/Unlock Solenoids

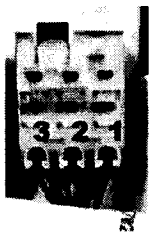

Unlock Solenoid
Lock Solenoid

Test Points

3 to 2
3 to 1

Reading

60 ohms
60 ohms

Door Lock Main Switches

To check the door lock main switches, the door must be locked. Begin by selecting a cycle and press START. You will hear the door lock solenoid engage. Unplug the washer from the wall outlet and check for continuity at the following points.

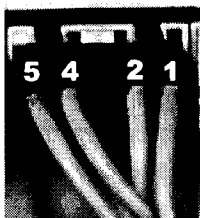

Main Switch 1
Main Switch 2

Test Points

5 to 4
2 to 1

Reading

0 ohms
0 ohms

Heating Element Relay Solenoid



Test Points
2 to 1

Reading
15 ohms

Door Switch



Door Closed
Door Open

Test Points
2 to 1
2 to 1

Reading
0 ohms
Infinity

MOTOR CONTROL UNIT

Connector Location

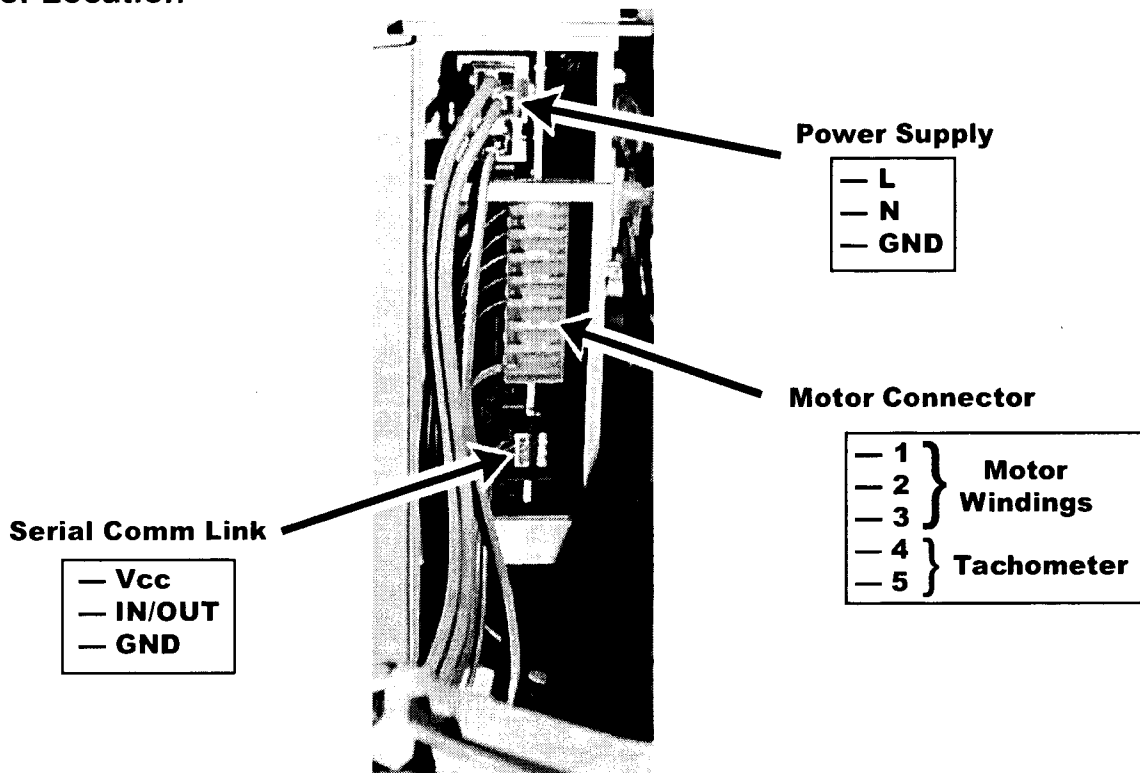

LINE FILTER

Test Points

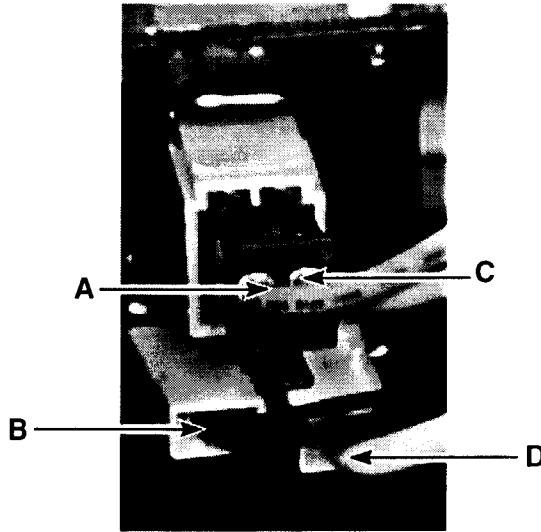

A to B = 0 ohms
C to D = 0 ohms

DISPENSER

Connector Location

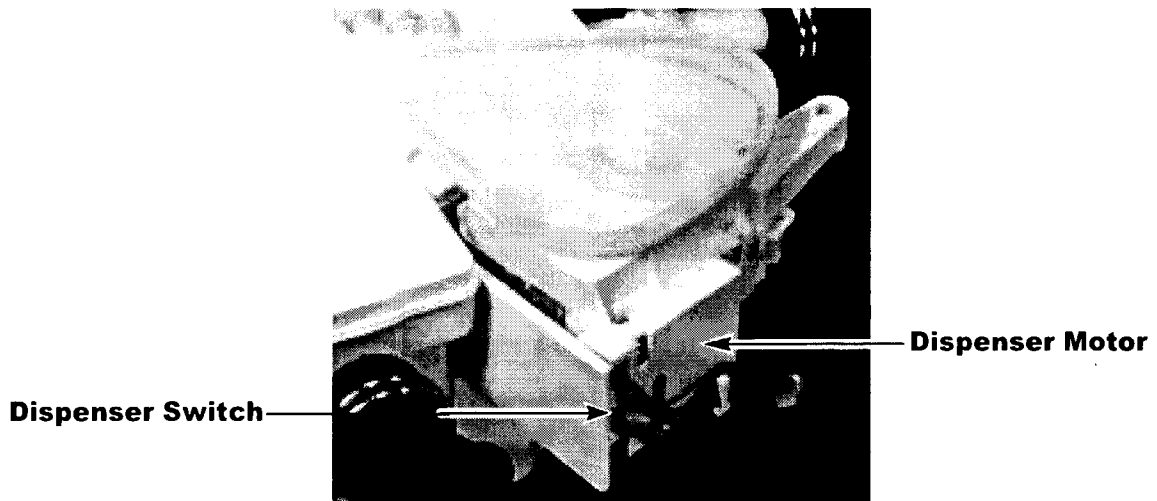

Dispenser Motor Continuity Check - 1400 Ω

PRESSURE SWITCH

Connector Location

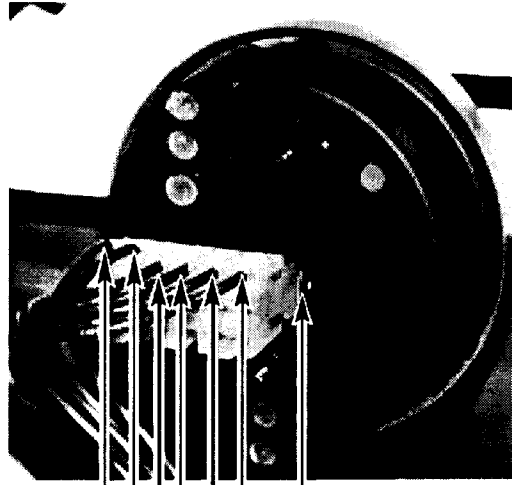

22 24 21 26 11 14 Blank

Water Level

- Empty
- Suds Detect
- Level 1
- Overflow

Contacts Made

- 21 to 22
- 11 to 14
- 21 to 24
- 21 to 26

HEATING ELEMENT and TEMPERATURE SENSOR

Connector Location

Heating Element Terminals

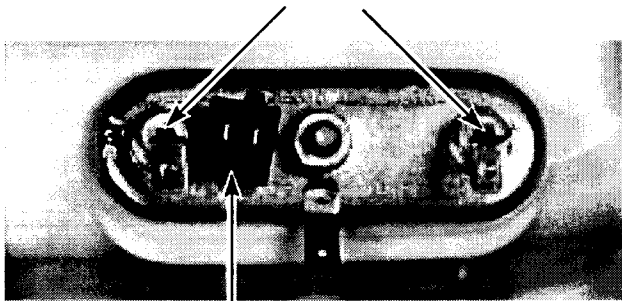

Temperature Sensor Terminals

Heating Element

Test Points	Reading
Between Terminals	15 ohms

Temperature Sensor

Temperature	Results
32° F (0° C)	35.9K Ω
86° F (30° C)	9.7K Ω
104° F (40° C)	6.6K Ω
122° F (50° C)	4.6K Ω
140° F (60° C)	3.2K Ω
158° F (70° C)	2.3K Ω
203° F (95° C)	1K Ω

HEATING ELEMENT RELAY SOLENOID

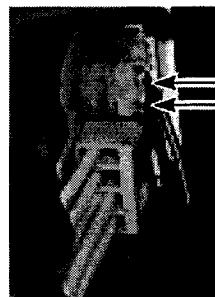

A to B = 15 ohms

Section Five

DIAGNOSIS AND TROUBLESHOOTING

SUDS DETECTION

During Drain Routine

During the Drain Routine, the water level is checked continuously. Normal drain will occur until the pressure switch senses no water in the wash tub and there is no foam (suds). The drain pump will operate an additional 15 seconds after the pressure switch reports no water or foam.

If the drain routine operates for four (4) minutes and the pressure switch senses any foam (suds) in the wash tub, the Central Control Unit will start the "Kill-Foam" Routine. (See description of this Routine below.) After the Kill-foam Routine is concluded, the Drain Routine will restart. If, after four (4) minutes the pressure switch still senses foam in the wash tub, the Central Control Unit will go into Failure Mode. The digital display will show, F02.

During Spin (Extract) Routine

During the Spin/Extract Routine the water level is checked continuously. If, during this routine, pressure switch senses the presence of foam (suds) in the wash tub, the Central Control Unit will stop the drive motor and the basket will stop spinning. The electronic control will count the number of spin repetitions that are attempted due to foam (suds). There are a maximum of three (3) attempts for each Spin/Extract Routine.

If count is equal to 0 - the Kill-Foam Routine is performed

If count is greater than 0 - the Central Control Unit will wait until the pressure switch does not sense foam in the wash tub and restart the Spin/Extract Routine.

Kill-Foam Routine

1. The Remaining Time counter is stopped.
2. The digital display shows Sud.
3. The Drain Pump is turned OFF.
4. The Central Control Unit will fill the wash tub with 1 gal. (4 L) of cold water.
5. While the tub is filling the basket will tumble 1 sec. ON/15 sec. OFF.
6. Once the tub is filled, the drive motor will turn OFF and the basket will rest without any movement for five (5) minutes.
7. After the five (5) minute rest, the remaining time counter will restart and the digital display will show the remaining time left in the routine.

NOTE: If the Kill-Foam routine was initiated during a Spin/Extract Routine, the tumbling action will be reduced to a cycle of 3 sec. ON/13 sec. OFF. If, at the end of either the Drain or Spin/Extract Routines, a suds condition still remains, the digital display will show Sud.

DOOR LOCKING AND UNLOCKING

Locking

The Door Locking Routine will only start if the door is securely closed and the Door Switch Contact is CLOSED.

1. The Door Lock Relay is energized whenever a wash cycle is started. The relay is operated for 40 milliseconds.
2. During the next three (3) seconds, the contacts on the door lock are checked by the central control unit
 - a. If the contacts are CLOSED, this routine is finished.
 - b. If the contacts are still open after 3 seconds, the Central Control Unit energizes the Door Lock Relay for 40 ms and then checks the door lock contacts for 3 seconds. This will occur a maximum of 6 times. If the door is not locked after 6 trials, the Central Control Unit will enter a failure mode and the digital display will show FdL.

Unlocking

Unlocking will occur only under the following conditions:

1. The drive motor speed equals 0 or the time since the drive motor STOP command has been sent to the Motor Control Unit is greater than 180 seconds.
2. The time since the inlet valve was CLOSED is greater than five (5) seconds.
3. If the temperature of the water is greater than 122° F (50° C), the water will be drained before unlocking will occur.
4. If the water level is higher than the wash level in the Delicate, Wool or Handwash cycles, the water will be drained before unlocking will occur.

The Unlocking Routine is:

1. The Door Unlock Relay is energized for 40 ms.
2. During the next three (3) seconds, the contacts of the Door Lock are checked. If the contacts are OPEN, the Unlocking Routine is finished.
3. If the contacts are still CLOSED after three (3) seconds, the Central Control Unit energizes the Door Unlock Relay for 40 ms. and then check the door lock contacts for three (3) seconds. If the door is not unlocked after 6 trials, the Central Control Unit will enter a failure mode and the digital display will show FdU.

Child Security Routine

The Child Security Routine is initiated at the start of a wash cycle.

1. The Door is Locked.
2. The tub fills with Cold water for three (3) seconds.
3. The door is Unlocked for five (5) seconds.
4. The door is Locked and the wash cycle begins.

Unbalance Detection Routine

There are three (3) Unbalance checks prior to the washer going into high speed spin.

Check 1 -

This check occurs during the distribution ramp (while basket spin is accelerating from 40 to 100 rpm).

- a. If the Motor Control Unit does not sense an unbalanced condition, the ramp will continue.
- b. If the Motor Control Unit senses an unbalanced condition, the drive motor is stopped. If the repetition counter for low speed spin is equal to 0, the Central Control Unit will advance to the next spin routine. If the repetition counter is greater than 0, the Central Control Unit will restart the current spin routine.

Check 2 -

This check occurs at the end of the distribution ramp (while basket spin is a constant 100 rpm).

ERROR CODES

DISPLAY	EXPLANATION AND RECOMMENDED PROCEDURE
F/H	<p>No water detected entering machine or Pressure switch trip not detected.</p> <p>If after 30 seconds the control does not detect water entering machine and then valves will be turned off and the error code will be displayed.</p> <p>Or</p> <p>If the control has turned the water valves on and after 8 minutes the flow meter has detected 10.5 gallons of water passing through it, but has not detected the pressure switch trip, the valves will be turned off and the error code will flash.</p> <p>Press PAUSE/CANCEL twice to clear the display.</p> <p>Potential Causes</p> <ul style="list-style-type: none"> • If there is no water in the unit: <ul style="list-style-type: none"> • Make sure that both valves at the water source(s) are turned on all the way. • Check for plugged or kinked inlet hoses or plugged screens in the inlet valves • Verify inlet valve operation • If there is water in the unit: <ul style="list-style-type: none"> • Verify Drain pump operation • Pressure Switch Hose is in good condition and properly connected to Tub and Pressure switch • Verify there is not a siphon problem • Verify wire harness connections to; Inlet Valves, Pressure Switch, Drain Pump, Flow Meter, and Central Control Unit (CCU) • Check all hoses for possible leaks • Verify pressure switch operation • Verify flow meter operation • Verify CCU operation
F/02	<p>Long Drain</p> <p>If the drain time exceeds 8 minutes, the water valves are turned off and "F/02" is flashed.</p> <p>Press PAUSE/CANCEL twice to clear the display.</p> <p>NOTE: After 4 minutes the "Sud" error will be displayed, then 4 minutes later the F/02 error code will be displayed.</p> <p>Potential Causes</p> <ul style="list-style-type: none"> • Check the drain hose and make sure it is not plugged or kinked • Check the electrical connections at the pump and make sure the pump is running. • Check the drain pump filter for foreign objects • If the above does not correct the problem replace the pump
F/05	<p>Water Temperature Sensor Error</p> <p>If during the water heating step in the wash cycle, the water temperature sensor (NTC) value is out of range, the "F/05" error code will be displayed.</p> <p>Potential Causes</p> <ul style="list-style-type: none"> • Check the Water Temperature Sensor • Check connections to the Water Temperature Sensor

ERROR CODES

DISPLAY	EXPLANATION AND RECOMMENDED PROCEDURE
F/06	<p>Drive Motor Tachometer Error</p> <p>The control is unable to properly detect motor speed and the machine will shut down. If a failure occurs during high-speed spin the door will be unlocked after 3 minutes.</p> <p>Potential Causes</p> <ul style="list-style-type: none"> • Check wire harness connections between the Drive Motor and the Motor Control Unit (MCU), and between the MCU and the Central Control Unit (CCU) • Replace the Drive Motor • Replace the MCU • Replace the Wire Harness
F/07	<p>Motor Control Unit Error</p> <p>The Central Control Unit has detected a short in the motor control unit. If a failure occurs during high-speed spin the door will be unlocked after 3 minutes.</p> <p>Potential Causes</p> <ul style="list-style-type: none"> • Check wire harness connections between the Drive Motor and the Motor Control Unit (MCU), and between the MCU and the Central Control Unit (CCU) • Replace the MCU • Replace the Drive Motor • Replace the Wire Harness
F/09	<p>Overflow Condition</p> <p>If the Overflow contact on the pressure switch is Closed for more than 60 seconds an Overflow condition will occur. In an Overflow condition, the Door will remain locked, and the Drain Pump will run constantly, even if PAUSE/CANCEL is pressed twice and the Display is cleared. Unplug the unit to service.</p> <p>Potential Causes</p> <ul style="list-style-type: none"> • Check the drain hose and make sure it is not plugged or kinked • Check Wire Harness connections to the Drain Pump, Pressure Switch, and Central Control Unit (CCU) • Check/ Clean Drain Pump Filter of foreign objects • Check for Drain Pump Failure • Check the Inlet Valve for proper shut off • Check the Pressure switch for proper operation
F/10	<p>Motor Control Unit (MCU) Heat Sink Thermal Trip</p> <p>If the thermal protector on the MCU heat sink gets too hot, it will open the thermal protector on the heat sink which will stop motor functions and an "F/10" will be displayed.</p> <p>Potential Causes</p> <ul style="list-style-type: none"> • Check for Proper Installation, verify the unit is not located near a source of heat and has proper ventilation. • Check Wire Harness connections to the MCU, the motor, and Central Control Unit (CCU) • Check the Drive system for any worn or failed components • Replace MCU • Replace Motor

ERROR CODES

DISPLAY	EXPLANATION AND RECOMMENDED PROCEDURE
F/11	<p>Serial Communication Error</p> <p>Communication between the Central Control Unit (CCU) and the Motor Control Unit (MCU) cannot be sent correctly.</p> <p>Potential Causes</p> <ul style="list-style-type: none"> • Check Wire Harness connections to the MCU, the motor, and Central Control Unit (CCU) • Check the Drive system for any worn or failed components • Replace MCU • Replace CCU • Replace Motor • Replace Wire Harness
F/13	<p>Dispenser Circuit Error</p> <p>If the dispenser motor is not able to be driven to it's proper position.</p> <p>Potential Causes</p> <ul style="list-style-type: none"> • Check mechanical linkage from dispenser motor to the top of the dispenser. • Check Wire Harness connections to the dispenser motor and Central Control Unit (CCU) • Replace Dispenser Motor
F/14	<p>EEPROM Error</p> <p>The Central Control Unit (CCU) receives it's data from an EEPROM on board the CCU. If there is an error reading this data it will cause this error.</p> <p>Potential Causes</p> <ul style="list-style-type: none"> • A power glitch may cause this error. Try unplugging the Unit for two minutes to see if that fixes the error. • Replace CCU.
F/15	<p>Motor Control Unit (MCU) Error</p> <p>If the MCU detects multiple resets or errors during a wash cycle it will go into this error mode.</p> <p>Potential Causes</p> <ul style="list-style-type: none"> • Check Wire Harness connections to the MCU, the motor, and Central Control Unit (CCU) • Check Drive belt • Replace MCU • Replace Motor • Replace Wire Harness
SuD	<p>SUDS LOCK (Overdose of Detergent detected during the Wash Cycle)</p> <p>The motor control unit senses a suds lock condition by analyzing the current draw on the drive motor. If "Sud" is displayed a potential suds lock is detected. This may signify a bad pump, an extra heavy load, excessive detergent, or excessive suds.</p>

ERROR CODES

DISPLAY	EXPLANATION AND RECOMMENDED PROCEDURE
	<p>Potential Causes</p> <ul style="list-style-type: none"> • If too much detergent was used, run the unit through a Rinse/ Spin cycle then a Normal cycle without adding any detergent. This should clear the unit of the excess detergent. • Check the drain hose and make sure it is not plugged or kinked • Check Wire Harness connections to the Drain Pump, Pressure Switch, and Central Control Unit (CCU) • Check/ Clean Drain Pump Filter of foreign objects • Check Drain Pump • Check the Pressure Switch • Check CCU
F/dL	<p>Door Lock Error</p> <p>A Door Lock Error occurs if the door cannot be locked. It will try to lock it 6 times before displaying the error.</p> <p>Potential Causes</p> <ul style="list-style-type: none"> • Door Lock Mechanism broken or removed from the Door • Check Door Lock/Switch Assembly • Check the wire harness connections to the Door Lock/Switch Assembly and Central Control Unit (CCU) • Door Lock/Switch Assembly Failure
F/dU	<p>Door Unlock Error</p> <p>A Door Unlock Error occurs if the door cannot be unlocked. It will try to unlock the door 6 times before displaying the error.</p> <p>Potential Causes</p> <ul style="list-style-type: none"> • Door Lock Mechanism broken. • Check Door Lock/Switch Assembly for foreign objects • Check Wire Harness connections to the Door Lock/Switch Assembly and Central Control Unit (CCU) • Door Lock/Switch Assembly Failure <p><i>Note:</i> The Door Lock/Switch Assembly can be manually unlocked. See Section Seven, TECH TIPS</p>

DIAGNOSTIC TEST

The control must be in the OFF state before pressing the touch-pad sequence to start the test.

Starting the test mode

Close the door.

Select the DRAIN/SPIN cycle.

Select NO SPIN by pressing the SPIN SELECT button five (5) times.

Push Prewash Option button four (4) times within five (5) seconds. C:00 will show in the display.

If the Starting procedure fails, push PAUSE/CANCEL button. Then repeat the starting sequence.

Test Program Control during Execution

To advance to the next step of the test procedure, push Prewash Option button two (2) times.

Overview Test Program

Indication	Control Action	Actuators to be Checked
C:00	Door is Locked	Door Lock System
C:01	Filling by cold water inlet valve	Flowmeter, Cold water inlet valve
C:02	Distribution system is set to Prewash position	Dispenser motor, Dispenser contact
C:03	Fill by hot water inlet valve	Hot water inlet valve
C:04	Drum rotates clockwise at wash speed	Motor, CIM control
C:05	Heater is switched ON. Drum rotates clockwise with wash speed. If there is not enough water in the tub, the water inlet valve will be switched ON to fill-in the minimum water quantity.	Heater, NTC
C:06	Drain Pump is ON	Drain Pump
C:07	Drum rotates counterclockwise from 35 to 90 rpm within 15 seconds	Motor, CIM control
C:08	Drum rotates counterclockwise with max. speed Drum speed > 1100 rpm	Motor, CIM control

Motor Continuity Test

Disconnect the wire harness from the motor and measure the resistance of the motor windings.

Motor Connector	Results
Pin 1 to Pin 2	Normal = approximately 6 Ω Abnormal = infinity
Pin 2 to Pin 3	Normal = approximately 6 Ω Abnormal = infinity
Pin 1 to Pin 3	Normal = approximately 6 Ω Abnormal = infinity

Water Temperature Sensor

Disconnect the wire harness from the water temperature sensor and measure the resistance of the sensor.

Temperature	Results
32° F (0° C)	35.9K Ω
86 ° F (30° C)	9.7K Ω
104° F (40° C)	6.6K Ω
122° F (50° C)	4.6K Ω
140° F (60° C)	3.2K Ω
158° F (70° C)	2.3K Ω
203° F (95° C)	1K Ω

TROUBLESHOOTING GUIDE

PROBLEM	POSSIBLE CAUSE/TEST
<p>Note: Possible Cause/Tests MUST be performed in the sequence shown for each problem.</p>	
WON'T POWER UP. (Touch-pads do not respond when pressed)	<ol style="list-style-type: none"> 1. Check the line voltage and for blown fuses. 2. Check for voltage going to Central Control Unit (CCU) by listening for a click in the CCU when unit is plugged in. If no click replace CCU. 3. Unplug the unit before continuing. 4. Check continuity of line cord and line filter. 5. Check harness connections to CCU. 6. Check touch-pad/LED assembly.
WON'T START CYCLE	<ol style="list-style-type: none"> 1. Open and close the door. The door has to be opened between consecutive wash cycles. 2. Check the door switch/lock unit using the diagnostics. 3. If Door is Locked, Drain the Unit. 4. Check the wire harness connections. 5. Check the touch-pad/LED assembly.
WON'T SHUT OFF	<ol style="list-style-type: none"> 1. Check for a Fault/Error Code on the display. 2. Press PAUSE/CANCEL button on the touch-pad twice. 3. Check the touch-pad/LED assembly 4. Check that the Drain hose and Drain Pump Filter is clear of foreign objects and not plugged. 5. Check Drain Pump. 6. Check the CCU.
CONTROL WON'T ACCEPT SELECTIONS	<ol style="list-style-type: none"> 1. Press PAUSE/CANCEL button on the touch-pad twice. 2. Drain the unit, then check that the Drain hose and Drain Pump Filter is clear of foreign objects. 3. Check/ Replace Touch-pad/LED assembly. 4. Check harness connections. 5. Check the CCU.
WON'T DISPENSE	<ol style="list-style-type: none"> 1. Verify the unit is level. 2. Verify Dispenser Drawer is not clogged with detergent. 3. Check water connections to the unit and within the unit. Check for plugged screen in water source. 4. Check Dispense motor. 5. Check harness connections. 6. Check CCU.
WON'T FILL	<ol style="list-style-type: none"> 1. Check installation. 2. Check inlet valves. 3. Check water connections to the unit and within the unit. Check for plugged screen in water source. 4. Check Operating Pressure Switch. 5. Check the CCU. 6. Check under problem "WON'T DISPENSE"

PROBLEM	POSSIBLE CAUSE/TEST Note: Possible Cause/Tests MUST be performed in the sequence shown for each problem.
OVER FILLS	<ol style="list-style-type: none"> 1. Verify the unit is level. 2. Check pump drain system – this could indicate a failure to drain. 3. Check Operating Pressure Switch. 4. Check Pressure Switch hose. 5. Check Flow Meter operation. 6. Check the CCU.
DRUM WON'T ROTATE	<ol style="list-style-type: none"> 1. Check Drive belt. 2. Check Drive motor. 3. Check Wire Harness connections. 4. Check Motor Control Unit.
MOTOR OVERHEATS	<ol style="list-style-type: none"> 1. Check Drive motor. 2. Check Wire Harness connections. 3. Check Drive belt. 4. Check Motor Control Unit.
WON'T DRAIN	<ol style="list-style-type: none"> 1. Check Wire Harness connections. 2. Check Drain pump. 3. Check Drain pump motor. 4. Check that the Drain hose and Drain Pump Filter is clear of foreign objects. 5. Check the CCU.
MACHINE VIBRATES	<ol style="list-style-type: none"> 1. Remove Shipping system. 2. Check installation. 3. Check leveling feet.
INCORRECT WATER TEMPERATURE	<ol style="list-style-type: none"> 1. Check that the Inlet Hoses are connected properly. 2. Check the Water Heater and Wire Harness connections to it. 3. Check Water Temperature Sensor for an abnormal condition. 4. Check the CCU.

READING THE CYCLE CHARTS

Sample Cycle Chart

		handwash																				
		wash phase				mainwash				rinse				additional rinse				rinse soft				extract
movement	speed [rpm]	0	31	31	0	0	0	31	0	0	0	31	0	0	31	0	0	31	0	600		
	reversing on=x sec / off=y sec	0	1.5/30.5	1.5/30.5	0	0	0	1.5/31.5	0	0	0	1.5/31.5	0	0	0	1.5/31.5	0	0	1.5/31.5	0		
	spin cycle																				LS3	
level		L1																				
dispenser box		mw				mw				mw				mw				soft				
temp	fill	tap cold				tap cold				tap cold				tap cold				warm				
	heating																					
	time	variable	90 sec	6.9 min	var	var	3 min	var							var	2.3 min	var			3 min		
door		closed				closed				closed				closed				closed				
pump (Lf + 15s)		off				on				off				on				on				
options																						
	2nd rinse									2.3 min												

Movement

- **Speed (rpm)** - Revolutions per minute of basket spin.
- **Reversing** - In this example the basket will rotate counterclockwise for 1.5 seconds, stop for 30.5 seconds, then rotate clockwise for 1.5 seconds, stop for 30.5 seconds and then repeat the sequence throughout the wash and rinse portions of the cycle.
- **Spin Cycle** - The spin cycle is described in the charts on pages 5-20 through 5-22. In this example the Hand Washable cycle will use the LS3 spin profile.

Level

- The pressure switch can detect three levels of water in the tub. L1 indicates the operating water level. In this example the water level allowed through out the cycle is level 2. In other cycles the water level can vary from L1 to L3. The pressure switch will fill to the L1 level, then the flowmeter will allow an additional 50% for L2 and an additional 150%, (from L1), to the L3 level.

Dispenser Box

- This line describes which portion of the dispenser box will be used during the cycle. In this example only the Main Wash (mw) and Fabric Softener (soft) are used. Other portions of the dispenser box are; Prewash (pw) and Bleach (bleach).

Temp

- **Fill** - The water temperature is variable based on consumer input and what is allowable by the cycle.
- **Heating** - This depends on whether the unit is equipped with a heating element and whether the cycle calls for heating. In this example the heater is not used

Time

- This line describes the length of time each portion of the cycle will take. The time for each fill portion is based on input from the pressure switch.

Door

- The door is locked throughout the cycle except for the Child Security Routine.

Pump

- **Lf +15s** - The pump will turn on and drain the tub to lowest fill level, (Suds Detect), and then run for an additional 15 seconds.

Options

- **2nd rinse** - If this option is selected by the consumer, this line indicates when it will occur during the main cycle and it's duration.

KENMORE HIGH RANGE

Models: 110.4282200, 110.42824200, 110.42826200, 110.42834200, 110.42836200

whitest whites

wash phase	soak		prewash	mainwash		cool down to 127°F		rinse bleach		additional rinse		rinse soft		extract			
	speed [rpm]	time		speed	temp	speed	temp	speed	temp	speed	temp	speed	temp	speed	temp		
reversing	40	35	40	40	800	40	800	40	35	800	40	35	250	600	800	1200	35
on-x sec. / off/y sec.	10/6	2/30	10/6	13/3	10/6	13/3	10/6	13/3	10/6	13/3	10/6	13/3	10/6				8/8
spin cycle					LS 1		LS 1			LS 1			LS 4	LS 4	LS 2	ES	
dispenser box																	
fill																	
heating																	
time																	
door																	
pump (L1 + 15s)																	
soak																	
prewash																	
2nd rinse																	
extended spin																	
fill																	
heating																	
time																	
options																	

heavy duty

wash phase	soak		prewash	mainwash		cool down to 127°F		rinse bleach		additional rinse		rinse soft		extract			
	speed [rpm]	time		speed	temp	speed	temp	speed	temp	speed	temp	speed	temp	speed	temp		
reversing	40	35	40	40	800	40	800	40	35	800	40	35	250	600	800	1200	35
on-x sec. / off/y sec.	10/6	2/30	10/6	13/3	10/6	13/3	10/6	13/3	10/6	13/3	10/6	13/3	10/6				8/8
spin cycle					LS 1		LS 1			LS 1			LS 4	LS 4	LS 2	ES	
dispenser box																	
fill																	
heating																	
time																	
door																	
pump (L1 + 15s)																	
soak																	
prewash																	
2nd rinse																	
extended spin																	
fill																	
heating																	
time																	
options																	

KENMORE HIGH RANGE
Models: 110.4282200, 110.42832200, 110.42824200, 110.42826200, 110.42834200, 110.42836200

sanitary

drum movement	wash phase speed [rpm]	soak	prewash	mainwash	cool down to 127°F	rinse bleach	additional rinse	rinse soft	extract
	reversing on=x sec / off=y sec spin cycle	40 35 40 10/6 2/30 10/6	40 35 40 13/3 10/6	40 35 40 13/3	40 35 40 10/6	40 35 800 13/3 10/6	40 35 800 13/3 10/6	40 35 250 10/6	600 800 1200 35
water level	L1								LS 4 LS 2 ES
temp	dispenser box fill	pw warm	pw warm	mw hot	mw tap cold	mw bleach tap cold	mw tap cold	mw soft tap cold warm	
	heating time	up to 153°F	8 min	up to 153°F	7.11 min	4 min	4 min	3.4 min	150 s
options	door	closed	closed	closed	closed	closed	closed	closed	closed
	pump (L1 + 15s)	off	on	off	on	off	on	off	on
	soak	off	on	off	on	off	on	off	on
	prewash								
	2nd rinse						3min		
	extended spin								10 min
	fill	warm	warm	warm					
	heating time	up to 153°F		up to 153°F	4.8 min				

Casual/Normal

drum movement	wash phase speed [rpm]	soak	prewash	mainwash	cool down to 90°F	rinse bleach	additional rinse	rinse soft	extract
	reversing on=x sec / off=y sec spin cycle	40 35 40 10/6 2/30 10/6	40 35 40 13/3 10/6	40 35 40 10/6	40 35 40 10/6	40 35 600 10/6	40 35 600 10/6	40 35 250 10/6	600 800 1200 35
water level	L1								LS 4 LS 2 ES
temp	dispenser box fill	pw tap cold warm	pw tap cold warm	mw tap cold hot	mw tap cold	mw bleach tap cold	mw tap cold	mw soft tap cold warm	
	heating time	up to 153°F	8 min	up to 153°F	9.25 min	4.5 min	3 min	3.5 min	110 s
options	door	closed	closed	closed	closed	closed	closed	closed	closed
	pump (L1 + 15s)	off	on	off	on	off	on	off	on
	soak	off	on	off	on	off	on	off	on
	prewash								
	2nd rinse						3.5 min		
	extended spin								12 min
	fill	warm	warm	warm					
	heating time	up to 120°F		up to 120°F	35.42 min				

KENMORE HIGH RANGE
Models: 110.4282200, 110.42824200, 110.42826200, 110.42834200, 110.42836200

wash phase	cool down to 127°F		mainwash		rinse bleach		additional rinse		rinse soft		extract	
	speed [rpm]	40	35	40	35	40	35	800	40	35	800	35
reversing	10/6	2/30	13/3	10/6	13/3	10/6	13/3	10/6	13/3	10/6	LS 4	LS 2
spin cycle				LS 4				LS 1			LS 4	ES
drum movement												
water level												
temp												
options												

wash phase	cool down to 90°F		mainwash		rinse bleach		additional rinse		rinse soft		extract	
	speed [rpm]	40	40	40	35	0	40	35	0	40	35	0
reversing	10/6	6/10	10/6	6/10	6/10	0	6/10	0	6/10	0	6/10	0
spin cycle												
drum movement												
water level												
temp												
options												

KENMORE HIGH RANGE
Models: 110.4282200, 110.4283200, 110.42824200, 110.42826200, 110.42834200, 110.42836200

wool = silk (without extract)

	wash phase		mainwash		rinse		additional rinse		rinse soft		extract	
	speed [rpm]	reversing	0	31	0	31	0	31	0	31		0
drum movement	0	1,5/30,5	0	1,5/30,5	0	1,5/31,5	0	1,5/31,5	0	1,5/31,5	0	
water level												LS3
temp	dispenser box	mw	tap cold..warm		mw	tap cold		mw	soft	mw	soft	
	fill						tap cold			tap cold..warm		
	heating											
	time	90 sec	6..9 min	var	3 min	var	closed	closed	2..3 min	var	closed	3 min
	door		closed		closed				closed			closed
	pump (Lf + 15s)		off	on	off	on	off	on	off	on	on	on
options	2nd rinse						2..3 min					

handwash

	wash phase		mainwash		rinse		additional rinse		rinse soft		extract	
	speed [rpm]	reversing	0	31	0	31	0	31	0	31		0
drum movement	0	1,5/30,5	0	1,5/30,5	0	1,5/31,5	0	1,5/31,5	0	1,5/31,5	0	
water level												LS3
temp	dispenser box	mw	tap cold..warm		mw	tap cold		mw	soft	mw	soft	
	fill						tap cold			tap cold..warm		
	heating											
	time	90 sec	6..9 min	var	3 min	var	closed	closed	2..3 min	var	closed	3 min
	door		closed		closed				closed			closed
	pump (Lf + 15s)		off	on	off	on	off	on	off	on	on	on
options	2nd rinse						2..3 min					

KENMORE MID RANGE
Models: 110.42922200, 110.42924200, 110.42934200, 110.42926200, 110.42936200

whitest whites

wash phase	prewash		mainwash to 127°F		rinse bleach		additional rinse		rinse soft		extract	
	speed [rpm]	35 40	800	40	35	800	40	35	800	40	35	250
reversing	40											
on=x sec / off=y sec	13/3		13/3	10/6	13/3	10/6	13/3	10/6	13/3	10/6	13/3	10/6
spin cycle			LS 1		LS 1		LS 1		LS 4		LS 4	LS 2 ES
drum												
water level												
temperature												
fill												
time												
door												
options												

heavy duty

wash phase	prewash		mainwash to 127°F		rinse bleach		additional rinse		rinse soft		extract	
	speed [rpm]	35 40	800	40	35	800	40	35	800	40	35	250
reversing	40											
on=x sec / off=y sec	13/3		13/3	10/6	13/3	10/6	13/3	10/6	13/3	10/6	13/3	10/6
spin cycle			LS 1		LS 1		LS 1		LS 4		LS 4	LS 2 ES
drum												
water level												
temperature												
fill												
time												
door												
options												

KENMORE MID RANGE
Models: 110.42922200, 110.42924200, 110.42934200, 110.42926200, 110.42936200

Casual/Normal

wash phase speed [rpm] reversing on=x sec / off=y sec spin cycle	prewash 40 13/3	mainwash		cool down to 90°F		rinse bleach		additional rinse		rinse soft		extract				
		40	10/6	35	250	600	40	35	600	40	35	250	600	800	900	35
water drum movement																
water level																
temperature																
options																

delicate

wash phase speed [rpm] reversing on=x sec / off=y sec spin cycle	prewash 40 10/6	mainwash		cool down to 90°F		rinse bleach		additional rinse		rinse soft		extract	
		40	10/6	0	40	35	0	40	35	0	250	800	35
water drum movement													
water level													
temperature													
options													

KENMORE MID RANGE

Models: 110.4292200, 110.42932200, 110.42924200, 110.42934200,
110.42926200, 110.42936200

handwash

wash phase		mainwash				rinse				additional rinse			rinse soft			extract		
drum movement	speed [rpm]	0	31	31	0	0	0	31	0	0	0	31	0	0	0	31	0	600
	reversing																	
	on=x sec / off=y sec	0	1,5/30,5	1,5/30,5	0	0	0	1,5/31,5	0	0	0	1,5/31,5	0	0	0	1,5/31,5	0	
	spin cycle																	LS3
water level		[Graph: Water level rising to L1 during mainwash]				[Graph: Water level rising to L1 during rinse]				[Graph: Water level rising to L1 during additional rinse]			[Graph: Water level rising to L1 during rinse soft]					
	L1																	
temperature	dispenser box	mw				mw				mw			mw soft					
	fill	cold..warm				tap cold				tap cold			tap cold..warm					
	time	var	90 sec	6..9 min	var	var	3 min	var				var	2..3 min	var	3 min			
	door	closed				closed				closed			closed			closed		
	pump (Lf + 15s)	off				on				off			on			on		
options	2nd rinse	[Shaded]				[Shaded]				2..3 min			[Shaded]					

SPIN PROFILES

Spin Cycle LS1

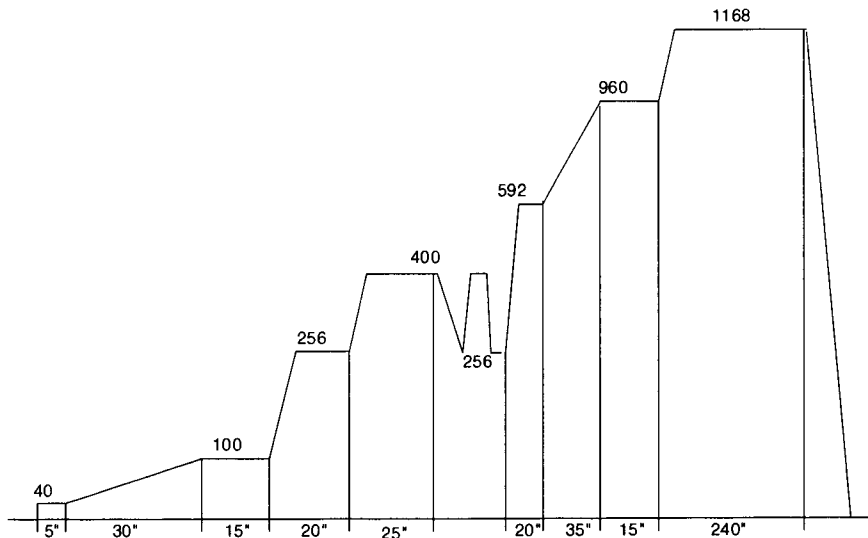

Spin Cycle LS2

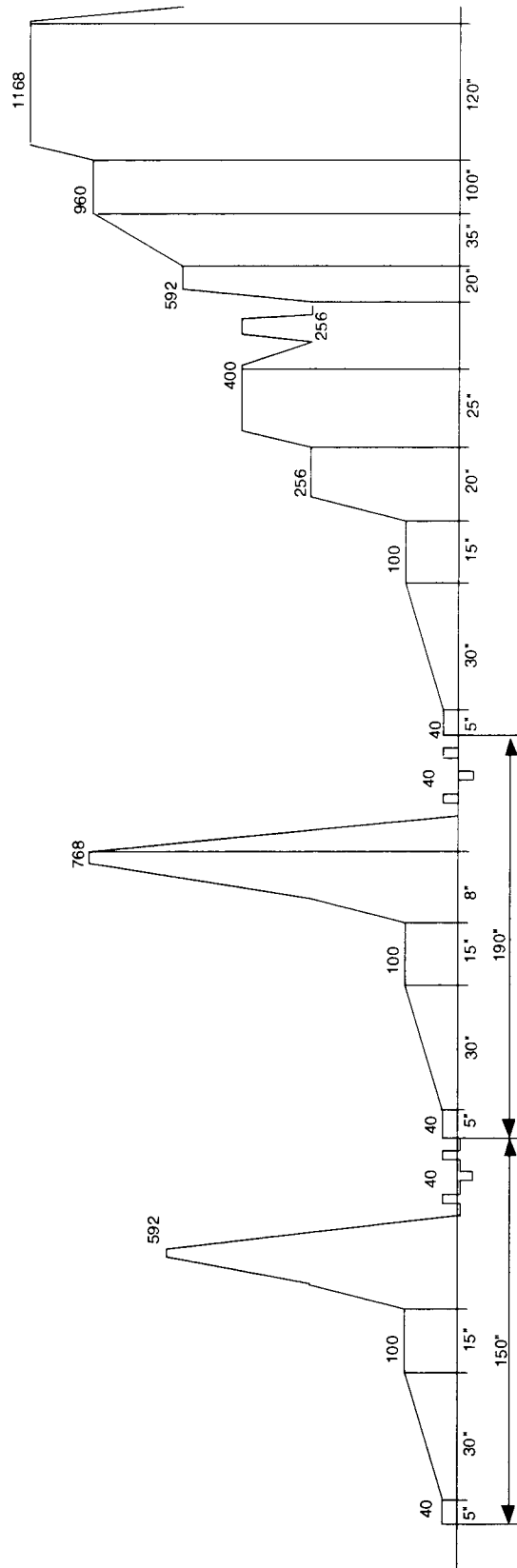

Spin Cycle LS3

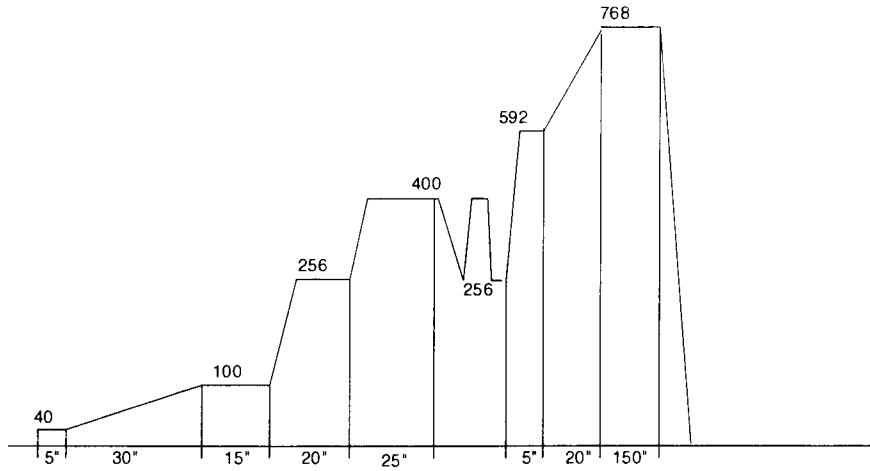

Spin Cycle LS4

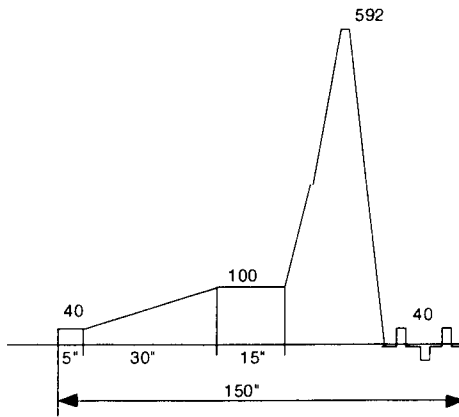

Spin Cycle ES

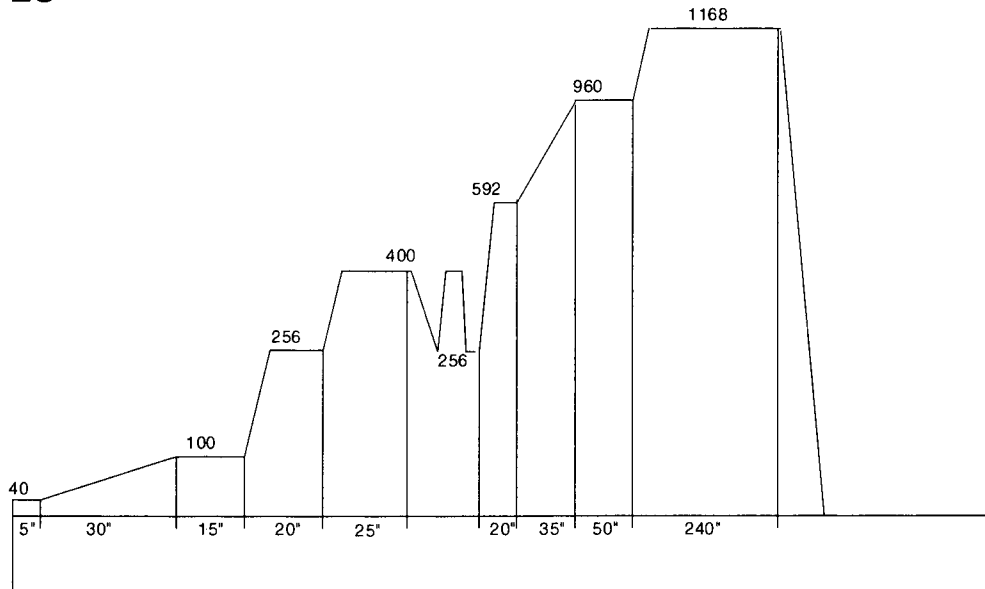

Section Six WIRING DIAGRAM

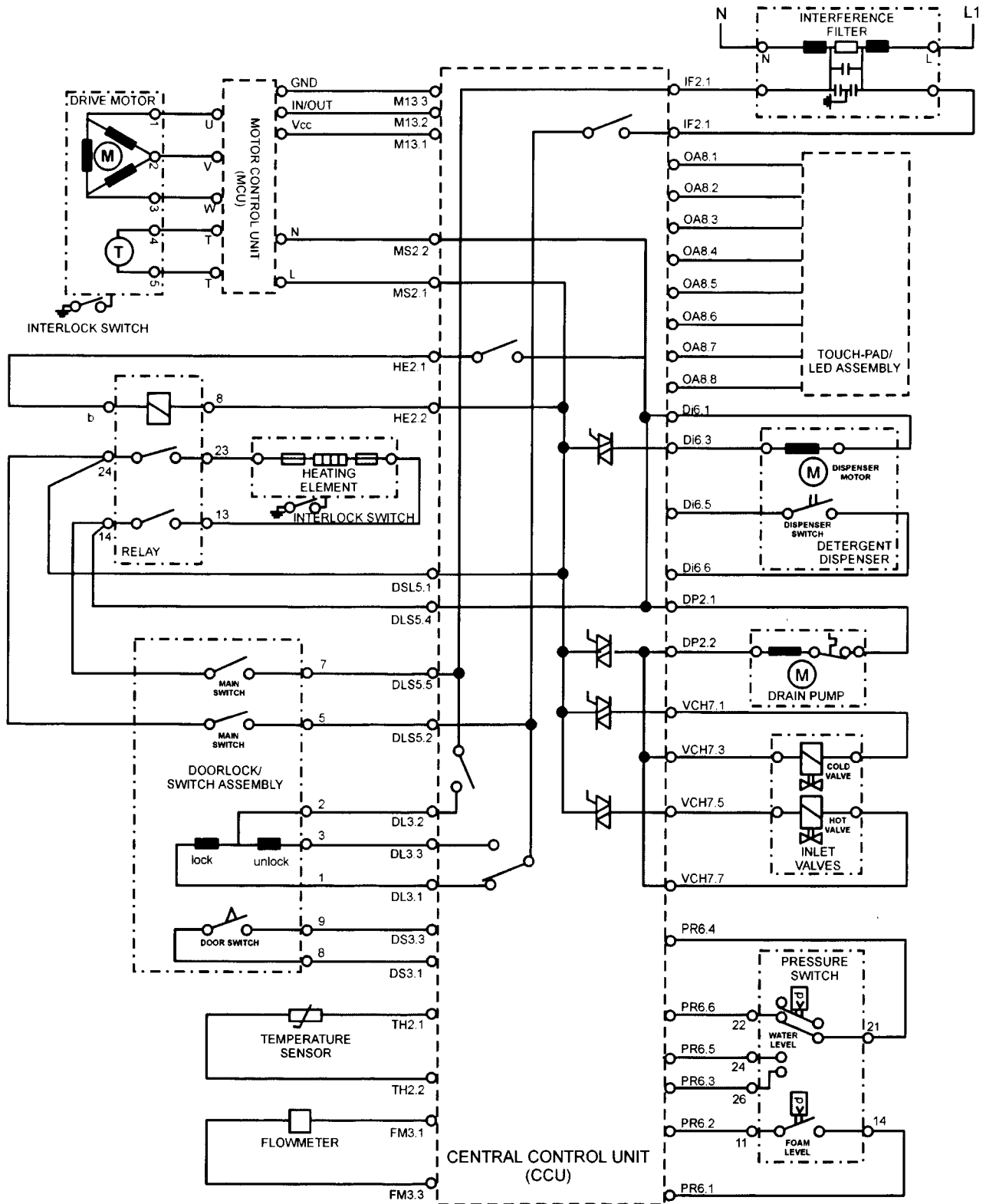

Section Seven

TECH TIPS

MANUAL DOOR LATCH

To Manually unlock the door lock system:

1. Unplug the power cord from the outlet.
2. Remove the lower toe panel.
3. Reach up along the inside of the front panel and locate the bottom of the door latch assembly.
4. Located on the bottom of the door latch assembly is a tear-drop shaped tab.
5. Gently pull the tab down about $\frac{1}{4}$ " or until a click is heard.
6. The door may now be opened.

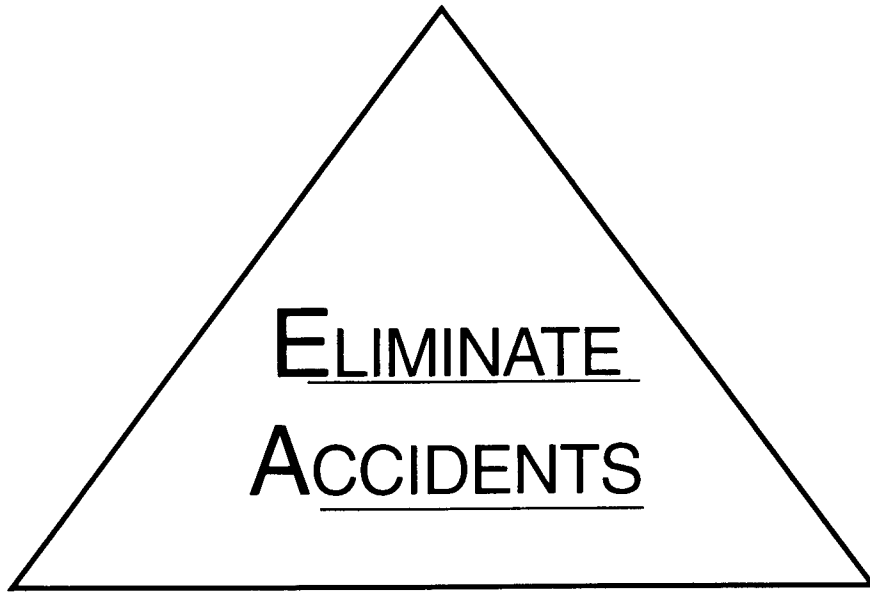

*You Can Count on me . . .
to Work Safely!*