



TITAN

aerotech™



Model OD302



Model OS302

MODELS

OD302US
OD302MUS
OD302MNZ
OD302EU

OS302US
OS302MUS
OS302MNZ
OS302EU

Manual 546596A – June 2005

Reprint: June 2005

The specifications and servicing procedures outlined in this manual are subject to change without notice.

The latest version is indicated by the reprint date and letter and replaces any earlier editions.

Fisher & Paykel Appliances Ltd
78 Springs Road, East Tamaki, PO Box 58-732,
Greenmount,
Auckland, New Zealand
Ph: 09 273 0600, Fax: 09 273 0656

Fisher & Paykel Appliances Inc
5800 Skylab Road, Huntington Beach, California,
CA92647, USA
Ph: 888 936 7872 (F&P), Ph: 888 396 2665 (DCS)

Fisher & Paykel Customer Services Pty Ltd
A.C.N. 003 3335 171, 19 Enterprise Street, Cleveland,
QLD 4163
PO Box 798, Cleveland, QLD 4163
Ph: 07 3826 9100, Fax: 07 3826 9164

Fisher & Paykel Appliances Ltd UK
Pheasant Oak Barn, Hob Lane, Balsall Common,
Warwickshire, CV7 7GX, UK
Ph: 44 1676 531 770, Fax: 44 1676 531 771

Contents

1. SERVICING REQUIREMENTS.....	7
1.1 HEALTH & SAFETY.....	7
1.1.1 Electrical Safety.....	7
1.1.2 Electrostatic Discharge.....	7
1.1.3 Good Working Practices.....	7
1.1.4 Insulation Test.....	7
1.1.5 Sheet Metal Edges.....	7
1.2 SPECIALISED TOOLS.....	8
1.2.1 Static Strap.....	8
1.2.2 Fisher & Paykel Smart Tool.....	8
2. TECHNICAL OVERVIEW.....	9
2.1 OVEN WEIGHTS.....	9
2.2 POWER RATING.....	9
2.3 OVEN CAVITY DIMENSIONS.....	9
2.4 LOCATION OF SERIAL PLATE.....	9
2.5 MODEL NUMBER.....	9
2.6 SERIAL NUMBER.....	10
2.7 OVEN CAVITY FAN (CONVECTION FAN).....	11
2.8 COOLING FAN.....	11
2.9 ACTIVE VENT FAN (EXHAUST FAN).....	12
2.10 OUTER BROIL / GRILL ELEMENT.....	12
2.11 INNER BROIL / GRILL ELEMENT.....	13
2.12 BAKE ELEMENT.....	13
2.13 FAN ELEMENT.....	13
2.14 SMOKE ELIMINATOR ELEMENT (CATALYTIC CONVERTER).....	14
2.15 THROAT ELEMENT.....	14
2.16 TEMPERATURE SENSOR.....	14
2.17 HALOGEN BULBS.....	14
2.18 MEAT PROBE & SOCKET.....	15
2.19 DOOR LOCK MOTOR.....	15
2.20 TEMPERATURE SWITCH MODULE.....	15
2.21 TEMPERATURE L.C.D MODULE.....	15
2.22 FUNCTION SWITCH MODULE.....	15
2.23 FUNCTION L.C.D MODULE.....	15
2.24 CLOCK MODULE.....	16
2.25 POWER MODULE.....	16
2.26 POWER TRANSFORMER.....	16
2.27 COOLING FAN RESISTOR.....	17
2.28 THERMAL LIMITERS.....	17
2.29 ISOLATING RELAY.....	19
2.30 XY-CAPACITOR.....	19
2.31 MICRO SWITCHES.....	19
2.32 SELF-CLEAN PYROLYTIC CYCLE.....	20
2.33 OVEN MODE ELEMENT AND FAN PROFILES.....	21
3. USE & CARE OF THE OVEN.....	22
3.1 SETTING THE CLOCK.....	22
3.2 OVEN MODE DIAL AND DISPLAY.....	22
3.3 TEMPERATURE DIAL AND DISPLAY.....	22
3.4 OVEN MODES.....	22
3.5 ACTIVE VENT AND COOLING FANS.....	23
3.6 MINUTE TIMER.....	24
3.7 SET AUTOMATIC / DELAYED TIME COOKING.....	24
3.8 SET AUTOMATIC STOP COOKING.....	25
3.9 USER SELECT MODES.....	25
3.10 SABBATH MODE.....	25
3.11 TEMPERATURE SCALE.....	26

- 3.12 SHORT ALERT26
- 3.13 TIME MODE26
- 3.14 SHOW CLOCK.....26
- 3.15 LANGUAGE27
- 3.16 OVEN RESET27
- 4. DIAGNOSTICS28**
- 4.1 ENTERING THE SALES MODE & TECHNICIAN MODE.....28
- 4.2 EXITING THE TECHNICIAN MODE.....28
- 4.3 TECHNICIAN MODE NAVIGATION28
- 4.4 ACCESSING TECHNICAL DATA LOG.....30
- 4.5 TECHNICAL DATA LOG.....30
- 5. FAULT DIAGNOSTICS.....31**
- 5.1 SYMPTOM: OVEN ELECTRICAL COMPONENTS ARE UNRESPONSIVE31
- 5.2 SYMPTOM: CONTROL BUTTONS OR CLOCK DISPLAY NOT OPERATING CORRECTLY OR UNRESPONSIVE.....32
- 5.3 SYMPTOM: TEMPERATURE OR OVEN MODE SWITCH MODULE IS JAMMED OR LOOSE32
- 5.4 SYMPTOM: INCORRECT TEMPERATURE OR OVEN MODE DISPLAY AT CORRECT SWITCH POSITION32
- 5.5 SYMPTOM: FAULTY TEMPERATURE OR OVEN MODE L.C.D. MODULES33
- 5.6 SYMPTOM: “DOORLOCK” AND “PROBE” SHOWING FOR LOWER CAVITY (DOUBLE OVEN ONLY).....33
- 5.7 SYMPTOM: OVEN UNDER COOKING.....34
- 5.8 SYMPTOM: BAKING BURNS ON THE TOP34
- 5.9 SYMPTOM: BAKING BURNS ON THE BOTTOM.....35
- 5.10 SYMPTOM: OVEN SEEMS TO BE FUNCTIONING NORMALLY BUT DOES NOT HEAT.....35
- 5.11 SYMPTOM: OVEN HEATS SLOWLY OR FAILS TO REACH PRESET TEMPERATURE.....36
- 5.12 SYMPTOM: OVEN LIGHTS DO NOT TURN ON / OFF.....36
- 5.13 SYMPTOM: FAULT CODE F1 DISPLAYED IN TECH SELECT ONLY37
- 5.14 SYMPTOM: FAULT CODE F2 DISPLAYED.....37
- 5.15 SYMPTOM: FAULT CODE F3 DISPLAYED.....37
- 5.16 SYMPTOM: FAULT CODE F4 DISPLAYED.....37
- 5.17 SYMPTOM: FAULT CODE F5 DISPLAYED.....38
- 5.18 SYMPTOM: FAULT CODE F7 DISPLAYED.....38
- 5.19 TRACING COOLING FAN FAULTS.....38
- 5.20 TRACING OVEN CAVITY FAN FAULTS.....39
- 5.21 TRACING OVEN LIGHT FAULTS39
- 5.22 TRACING ELEMENT FAULTS.....40
- 5.23 TRACING OVEN TEMPERATURE SENSOR FAULTS.....41
- 5.24 TRACING THERMAL LIMITER FAULTS41
- 5.25 TRACING OVEN DOOR SWITCH AND DOOR LOCK SWITCH FAULTS.....42
- 5.26 DETERMINING WHICH POWER MODULE IS FAULTY IN A DOUBLE OVEN (F4 OR F5 FAULT CODES)43
- 6. WIRING DIAGRAMS44**
- 6.1 DOUBLE OVEN USA WIRING SCHEMATIC.....44
- 6.2 SINGLE OVEN USA WIRING SCHEMATIC.....45
- 6.3 DOUBLE OVEN NZ / AUS WIRING SCHEMATIC46
- 6.4 SINGLE OVEN NZ / AUS WIRING SCHEMATIC47
- 6.5 DOUBLE OVEN EU WIRING SCHEMATIC.....48
- 6.6 SINGLE OVEN EU WIRING SCHEMATIC49
- 7. SERVICE PROCEDURES.....50**
- 7.1 REMOVAL FROM JOINERY CAVITY.....50
- 7.2 COMPONENTS IN CONTROL PANEL AREA50
- 7.3 COMPONENTS IN BACK PANEL AREA.....51
- 7.4 COMPONENTS IN SERVICE PANEL AREA51
- 7.5 REASSEMBLY PROCEDURE.....51
- 7.6 FUNCTION AND TEMPERATURE SWITCH MODULES.....52
- 7.7 FUNCTION AND TEMPERATURE L.C.D. MODULES AND LENSES52
- 7.8 CLOCK MODULE OR BUTTONS.....53
- 7.9 POWER MODULE.....54
- 7.10 POWER TRANSFORMER57
- 7.11 THERMAL LIMITER.....57
- 7.12 OVEN TEMPERATURE SENSOR57
- 7.13 OVEN LAMP GLASS AND BULB58
- 7.14 OVEN LAMP ASSEMBLY.....58

7.15 OVEN ELEMENTS	60
7.16 COOLING FAN	62
7.17 VENT FAN	62
7.18 OVEN CAVITY FAN	63
7.19 FAN SHROUD.....	63
7.20 RUNNERS	64
7.21 OVEN DOOR.....	64
7.22 OVEN DOOR – DISASSEMBLY	64
7.23 MEAT PROBE SOCKET.....	67
7.24 OVEN DOOR LOCK ASSEMBLY.....	68
7.25 COMPONENT LOCATION GUIDE.....	69

1. Servicing Requirements

1.1 Health & Safety

Note: When servicing the Titan Aerotech™ oven, health and safety issues must be considered at all times. Specific safety issues are listed below with their appropriate icon. These are illustrated throughout the service information to remind service people of the health and safety issues.

1.1.1 Electrical Safety



WARNING! TO AVOID ELECTRIC SHOCK!

Do not attempt to service this oven without suitable training and qualifications.

Ensure the mains power has been disconnected before servicing any part of the oven. If the power is required to be on for electrical fault finding, then **extreme** care should be taken not to make contact with electrical components other than with testing probes. Ensure the oven is turned off when removing any electrical component or connection.

1.1.2 Electrostatic Discharge

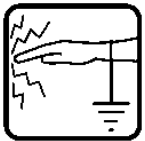

An anti-static strap is to be used as electrical static discharge (ESD) protection when servicing electronic components.

1.1.3 Good Working Practices



Ensure the work areas are kept tidy and free of hazards while servicing the oven. On completion of the servicing, ensure the oven and work areas are left clean and tidy.

1.1.4 Insulation Test



Megger test to check insulation.

Warning Short together the phase and neutral terminals to avoid damaging any electronic circuitry.

1.1.5 Sheet Metal Edges



When working around cut sheet metal edges use appropriate gloves or protection to eliminate the chance of receiving a laceration.

1.2 Specialised Tools

1.2.1 Static Strap

The static strap is to be used as E.S.D. protection when replacing or handling electronic components.

1.2.2 Fisher & Paykel Smart Tool

Handheld computer supplied in protective case with F&P diagnostics software and service information loaded:

P/N 813140 (includes light pen P/N 425930).

2. Technical Overview

2.1 Oven Weights

OS302 Weight: 190 lbs. (86 Kg)
OD302 Weight: 340 lbs. (154 Kg)

2.2 Power Rating

	Single Supply Voltage	Rating	Double Supply Voltage	Rating
USA / Can	3wire 120/240v	5.1kW	3wire 120/240v	9.2kW
USA / Can	120/208v	3.9kW	120/208v	7kW
NZ / AUS	220/240v	4.7kW	220/240v	8.5kW
EU	220/240V	4.7kW	220/240V	7.6kW

2.3 Oven Cavity Dimensions

Width	24"	(610mm)
Height	16"	(405mm)
Depth	16"	(405mm)
Cavity Volume	3.5 cu ft	(0.1 m ³)

2.4 Location of Serial Plate

The product serial plate is located on the left-hand side behind the grill, between the control panel and the oven door (top oven door on dual oven models).

2.5 Model Number

The model number contains the following information:

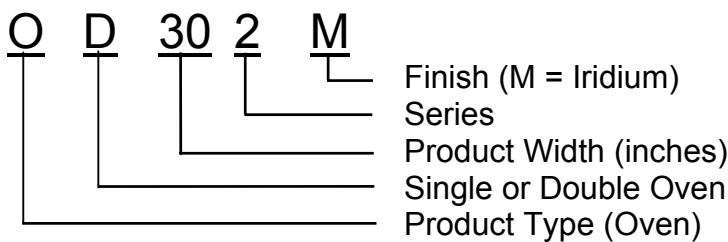

2.6 Serial Number

The serial number consists of three letters and six digits and contains the following information:

Example:

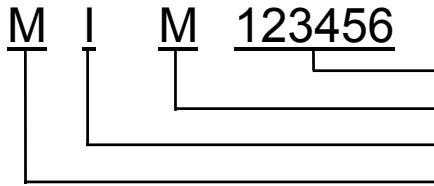

Sequential Serial Number
 Manufacturing Plant Code
 FISHERPAYKUL Code indicates month of manufacture
 CUMBERLAND Code indicates year of manufacture

Cumberland Code

Letter C	U	M	B	E	R	L	A	N	D
Year 1	2	3	4	5	6	7	8	9	0

Fisherpaykul Code

Letter F	I	S	H	E	R	P	A	Y	K	U	L
Month 1	2	3	4	5	6	7	8	9	10	11	12

Manufacturing Plant Code

A	Laundry – Australia
F	Refrigeration – New Zealand
M	Range & Dishwasher
N	Laundry – New Zealand
Q	Refrigeration - Australia

In the example above, the appliance was manufactured in the second month of the third year (2003) at the Range & Dishwasher plant.

2.7 Oven Cavity Fan (Convection Fan)

- The oven cavity fan will turn on eight seconds after a mode is selected.
- The fan should always operate when the fan element is on.

Operational Modes: True Aero
 Aero Bake
 Aero Pastry
 Aero Broil / Grill
 Roast (first 20 minutes only)
 Warm
 Bake (pre-heat assistance only)
 Pastry Bake (pre-heat assistance only)

Voltage: 240 VAC
Wattage: 35 watts
Frequency: 60 HZ

2.8 Cooling Fan

- The cooling fan will turn on as soon as the oven mode is moved from the 'OFF' position. It will turn off after eight seconds if a temperature isn't selected.
- The cooling fan will only turn off if the oven cavity has cooled below 300°F (150°C) after use.
- If the oven cavity temperature is above 550°F (290°C) the cooling fan will run at high speed.
- During the Self-Clean Cycle the cooling fan in the cavity being cleaned will run at high speed, the other cavity will run on low (in a double oven).

	<u>NZ/AUS/EU</u>	<u>U.S</u>
Voltage:	230/240 VAC	115/120 VAC
Frequency:	50/60 HZ	60 HZ
Wattage:	60 watt	56 watt

Cooling Fan Speeds*

Oven Mode	Cooling Fan Speed
Bake	Low Low
Aero Bake	Low Low
Warm	Low Low
True Aero	Low Low
Maxi Broil / Grill	Hi Low
Broil / Grill	Hi Low
Aero Broil / Grill	Hi Low
Pastry Bake	Low Low
Aero Pastry	Low Low
Roast (Aero Broil / Grill 1 st 20 min)	Hi Low
Roast (Bake for remainder)	Low Low
Self-Clean Cycle	Hi Low

***The top speed refers to single ovens or the cavity being used in a double oven.**

2.9 Active Vent Fan (Exhaust Fan)

The vent fan will operate for the first thirteen minutes of all oven modes except Warm (does not operate) and Self-Clean Cycle, Broil / Grill modes (runs continuously).

Voltage: 230/240 VAC
Frequency: 50/60 HZ
Wattage: 18 watt

2.10 Outer Broil / Grill Element

The outer broil / grill element will turn on eight seconds after a mode is selected.

Operational Modes: Bake
 Aero Bake
 Warm
 Maxi Broil / Grill
 Aero Broil / Grill
 Roast
 Self-Clean

Voltage: 230/240 VAC
Wattage: 1500 watt

2.11 Inner Broil / Grill Element

The inner broil / grill element will turn on eight seconds after a mode is selected.

Operational Modes: Broil / Grill
Maxi Broil / Grill
Aero Broil / Grill
Roast (first 20 minutes only)
Self-Clean

Voltage: 230/240 VAC
Wattage: 2900 watt

2.12 Bake Element

The bake element is concealed under the cavity base and will turn on eight seconds after a mode is selected.

Operational Modes: True Aero (pre-heat assistance only)
Bake
Aero Bake
Warm
Pastry Bake
Aero Pastry
Roast
Self-Clean

Voltage: 230/240 VAC
Wattage: 1500 watt

2.13 Fan Element

The fan element and oven fan will turn on eight seconds after a mode is selected.

Operational Modes: True Aero
Bake (pre-heat assistance only)
Aero Bake
Aero Pastry (pre-heat assistance only)
Pastry Bake (pre-heat assistance only)

Voltage: 230/240 VAC
Wattage: 2500 watt

2.14 Smoke Eliminator Element (Catalytic Converter)

(This is a non-serviceable part)

The smoke eliminator element is designed to neutralise gases produced during cooking.

Operational Modes: Broil / Grill
Aero Broil / Grill
Maxi Broil / Grill
Self clean
Bake
Aero Bake
Pastry Bake
Aero Pastry
Roast
True Aero

Voltage: 230/240 VAC
Wattage: 150 watt

2.15 Throat Element

(This is a non-serviceable part)

The throat element is designed to ensure all parts near the front of the oven cavity reach the required temperatures during the Self-Clean Cycle.

Operational Modes: Self-Clean

Voltage: 230/240 VAC
Wattage: 540 watt

2.16 Temperature Sensor

Voltage: 5 VDC
Max current: 2 mA
Max ambient temp: 1000°F (540°C)
Resistance: 1080.2 ohms +/- 5.2 ohms at 70°F (21.11°C)

2.17 Halogen Bulbs

- The oven cavity lights will come on when the door is opened or when an oven mode is selected.
- The lights will turn off when the door is closed (if no oven mode is selected) or if the programmed oven cook time has finished.
- There are three soft start halogen bulbs in each oven cavity.

Voltage: 12 VAC
Wattage: 20 watt

2.18 Meat Probe & Socket

Voltage: 5 VDC



Figure 2.18

2.19 Door Lock Motor

The door lock will only operate during the Self-Clean Cycle and is designed to stop the oven door being opened when very high temperatures and potentially dangerous fumes are produced in the oven cavity.

Voltage: 12 VDC
Duty cycle: On 2 sec Off 5 sec
Stall current: under 0.5 Amp

2.20 Temperature Switch Module

The temperature switch module controls the temperature settings of the oven. It has a data link to the clock module.

Current Draw: 72 mA



Figure 2.20

2.21 Temperature L.C.D Module

The temperature LCD module is controlled by the clock module. It displays the temperature set by the temperature switch module.

Current Draw: 72 mA

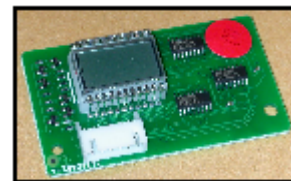

Figure 2.21

2.22 Function Switch Module

The function switch module sets the oven mode to be used. It has a data link to the clock module.

Current Draw: 72 mA



Figure 2.22

2.23 Function L.C.D Module

The function LCD module is controlled by the clock module. It displays the oven mode selected by the function switch module.

Current Draw: 72 mA

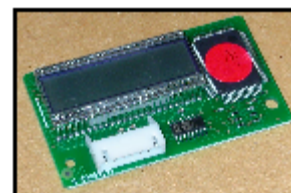

Figure 2.23

2.24 Clock Module

The clock module contains a flash micro-controller that controls all oven electrical components. Data can be accessed from the micro-controller using the Fisher & Paykel Smart Tool light pen or comms. connection.

Current Draw: 200 mA

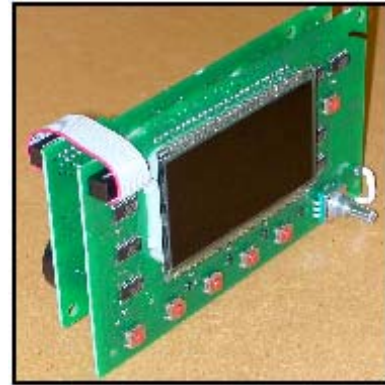

Figure 2.24

2.25 Power Module

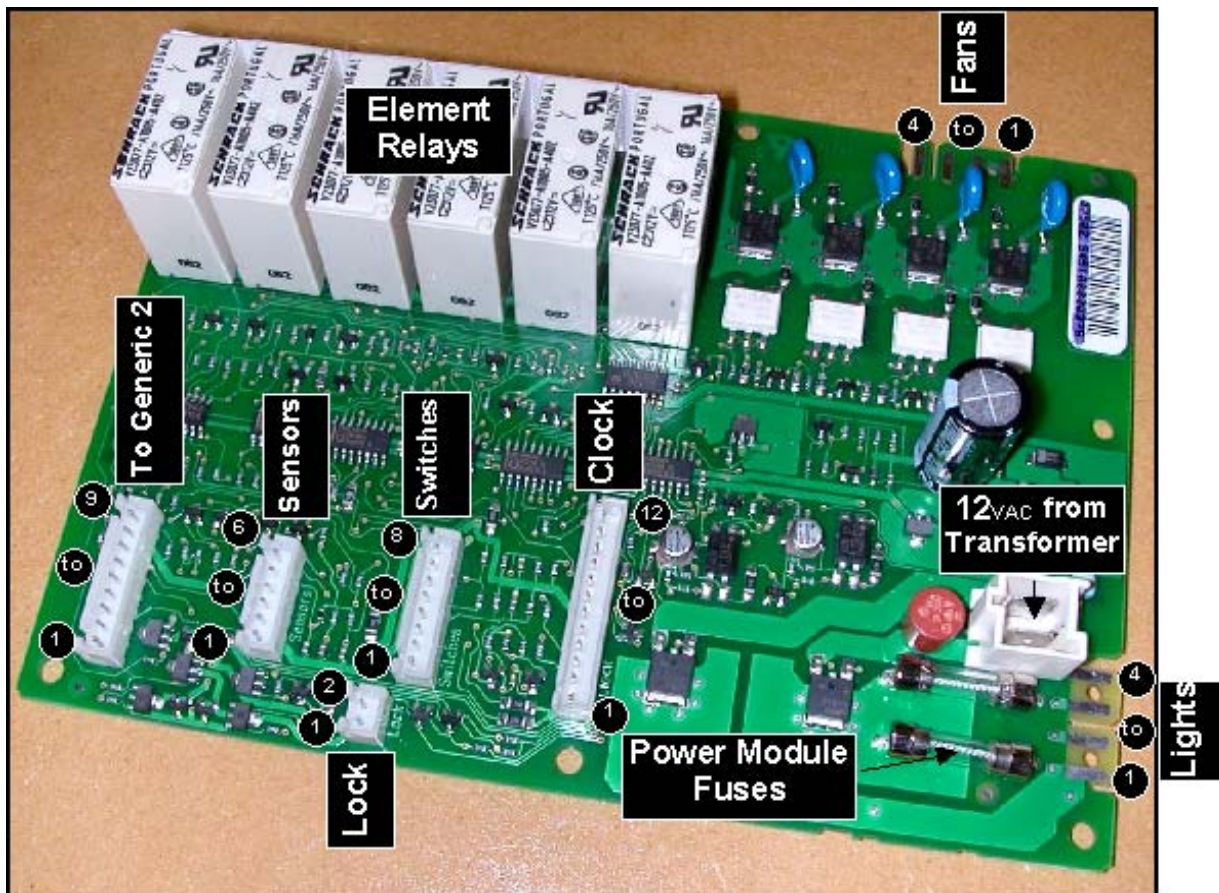

Figure 2.25

The power module is a Fisher & Paykel specific P.C.B. that drives oven lights, fans, elements and lock motors. It also monitors the sensors and micro-switches and provides power to the control panel.

Voltage: 12 VAC

2.26 Power Transformer

USA	12v/120v	60hz
NZ/AUS/EU	12v/240v	50hz

2.27 Cooling Fan Resistor

Power Rating: 50 watt
Resistance: 220 Ohms
Max Ambient Temp: 85°C (185°F)

2.28 Thermal Limiters

If a thermal limiter has tripped there will be no continuity across the contacts.

Limiter Locations for US/NZ/AUS Products

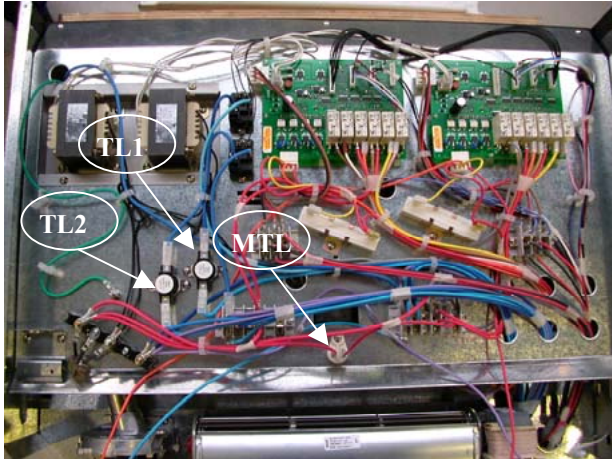

Figure 2.28a

Note: TL = Thermal Limiter
MTL = Microtemp limiter

Double ovens have thermal limiters 1,2 & 3 and a microtemp limiter.

Single ovens have thermal limiter 1 and a microtemp limiter.

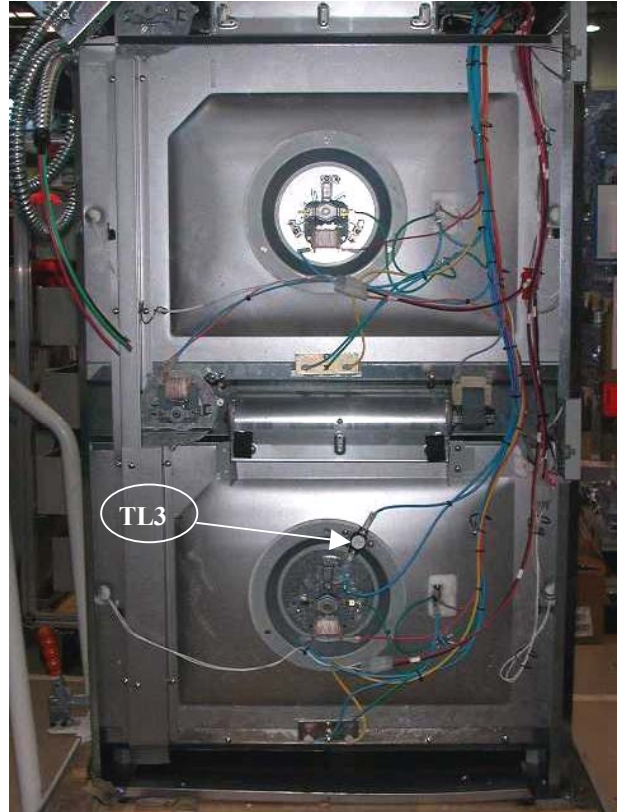

Figure 2.28b

Limiter Locations for EU Products

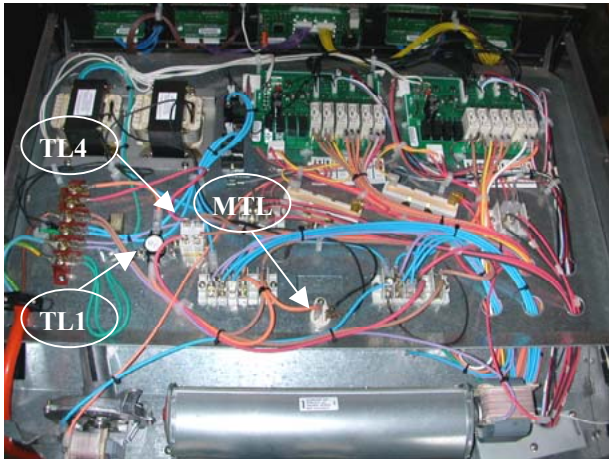

Figure 2.28c

Note: TL = Thermal Limiter
 MTL = Microtemp thermal limiter

Double ovens have thermal limiters 1, 3, 4 & 5 and a microtemp limiter.

Single ovens have thermal limiters 1 & 4 and a microtemp limiter.



Figure 2.28d

MTL (Microtemp Limiter)

This is a non-resettable thermal limiter positioned to detect electronics area over temperature caused by a cooling fan failure. It will cut power to the power transformers, disabling the oven when tripped.

Capacity Rating: 25 Amps at 240 VAC.

Trip Temperatures: 200°F (93°C)



Figure 2.28e

TL 1 & TL 2

These are non-resettable thermal limiters positioned to detect the upper cooling fan failure on a double oven. They will cut power to the oven elements when tripped.

Capacity Rating: 25 Amps at 240 VAC.

Trip Temperatures: 175°F (80°C)



Figure 2.28f

TL 3

This is a non-resettable thermal limiter positioned to detect lower cooling fan failure on a double oven. It will cut power to the oven elements when tripped.

Capacity Rating: 25 Amps at 240 VAC.

Trip Temperatures: 230°F (110°C)

TL 4 (EU Products Only)

This is a resettable thermal limiter positioned to detect the upper cooling fan failure on a double oven. It will cut power to the oven elements when tripped.

Capacity Rating: 16 Amps at 250 VAC.
Trip Temperatures: 175°F (80°C)



Figure 2.28g

TL 5 (EU Products Only)

This is a resettable thermal limiter positioned to detect lower cooling fan failure. It will cut power to the oven elements when tripped.

Capacity Rating: 16 Amps at 250 VAC.
Trip Temperatures: 230°F (110°C)

2.29 Isolating Relay

(Double Line Break Relay)

- This relay switches the elements, cavity fan and vent fan on the opposite side to the power module relay switches.
- It is only energised when an oven mode is selected.

Coil Voltage: 12 VDC
Coil Input: 1 watt



Figure 2.29

2.30 XY-Capacitor

This capacitor provides surge protection for the oven.

Voltage: 250 VAC
Class: X2Y2
Temp Range: -105 to 210°F (- 40 to 100°C)

2.31 Micro Switches

There are three micro switches in the door lock assembly.

Voltage 12 VDC

2.32 Self-Clean Pyrolytic Cycle

Duration:	3hrs
Pyro Temp:	925°F (500°C)
Heat-up time:	50 minutes approx.
Holding time:	100 minutes approx.
Cool-down time:	30 minutes

- If a Self-Clean Cycle will not start, check that there are no meat probes inserted and that the control knobs of the cavity not being cleaned (in a double oven) are in the 'OFF' position.
- The oven self-clean mode operates by heating the oven to a temperature of approximately 885°F (473°C). This burns off and breaks down soil and grease deposits. The ash residue that remains can simply be removed from the cool oven with a damp cloth or sponge. The self-clean cycle normally takes about three hours.
- **To start a Self-Clean Cycle**
 1. Turn the oven mode dial until 'Self Clean' appears in the display.
 2. Select the maximum temperature using the temperature dial.
 - '000' will appear in the temperature display. This will change to _ _ when the cycle begins.
 - 'Door Lock' and 'Clean' will show in the clock display.
- The door lock will automatically activate once the Self-Clean mode and maximum temperature have been selected.
- A countdown of minutes remaining will be shown in the clock display.
- The Broil / Grill inner element, the throat element, the smoke eliminator element and the vent fan operate during the Self-Clean Cycle. Additionally, during the first fifteen seconds of each minute the bake element is on and during the third fifteen seconds of each minute the Broil / Grill outer element is on.
- The cooling fan for the cavity being cleaned will be on high speed. The cooling fan for the other cavity will be on low speed.
- During the Self-Clean Cycle in a double oven, the cavity not being cleaned cannot be operated in any mode.
- The oven heats to its cleaning temperature of 885°F (473°C) and maintains this temperature until approximately 2½ hours into the cycle.
- The elements then turn off and the cool down period commences. When the temperature reduces to 356°F (180°C) the door will unlock and the 'Door Lock' display will disappear from the clock display.
- When the self-clean cycle has finished, 'Clean' and '00:00' will flash in the clock display until it is returned to manual operation. Press the PUSH TO CLEAR button and turn the oven mode and temperature dials to the OFF position to do this.
- At the completion of the self-clean cycle, there may be grey ash deposited on the inside of the oven. The amount of ash is dependent on the amount of soil in the oven before cleaning. To remove the ash, wait until the oven has completely cooled. The bulk of the ash is easily removed with a small brush or dry cloth, then wiped over with a damp cloth.
- The self-clean mode can be cancelled at any time by turning the oven dials to 'OFF'. 'Clean End' will appear in the oven mode display but if the oven temperature has already reached 482°F (250°C) the door lock will remain activated until the oven cools to 356°F (180°C).

2.33 Oven Mode Element and Fan Profiles

If the oven door is opened during use the oven fan and elements will turn off until it is closed again.

Oven Mode Name	Oven Fan	Cool Fan Speed	Vent Fan	Broil/Grill Outer Element	Broil/Grill Inner Element	Bake Element	Fan Element	Throat Element	Smoke Elim.
Bake	(on for pre-heat only)	Low Low	(on for first 13 mins)	ON		ON	(on for pre-heat only)		ON
Aero Bake	ON	Low Low	(on for first 13 mins)	ON		ON	ON		ON
Warm	ON	Low Low		ON		ON			
True Aero	ON	Low Low	(on for first 13 mins)			(on for pre-heat only)	ON		ON
Maxi Broil/Grill	OFF	Hi Low	ON	ON	ON				ON
Broil/Grill	OFF	Hi Low	ON		ON				ON
Aero Broil/Grill	ON	Hi Low	ON	ON	ON				ON
Pastry Bake	(on for pre-heat only)	Low Low	(on for first 13 mins)			ON	(on for pre-heat only)		ON
Aero Pastry	ON	Low Low	(on for first 13 mins)			ON	(on for pre-heat only)		ON
Roast (Aero Broil/Grill 1 st 20Min)	ON	Hi Low	(on for first 13 mins)	ON	(on for first 20 mins)				ON
Roast (Bake for remainder)	OFF	Low Low	(on for first 13 mins)	ON		ON			ON
Heating Profile for Self-Clean Pyrolytic Cycle									
Self Clean (0-15sec)	OFF	Hi Low	ON		ON	ON		ON	ON
(15-30sec)	OFF	Hi Low	ON		ON			ON	ON
(30-45sec)	OFF	Hi Low	ON	ON	ON			ON	ON
(45-60sec)	OFF	Hi Low	ON		ON			ON	ON

3. Use & Care of the oven

3.1 Setting the Clock

The clock has a default 12 hour display and a minute timer function. 'AM 12:00' will show and the colon will flash when the oven has been turned on at the wall. While the colon is flashing, rotate the PUSH TO CLEAR knob until the correct time of day is displayed. Press CLOCK or wait 8 seconds until the colon stops flashing to adopt the time that has been set.

3.2 Oven Mode Dial and Display

This is turned to select the desired oven mode. When the mode is set the lights and cooling fan will come on.

3.3 Temperature Dial and Display

This is turned to select the desired temperature.

3.4 Oven Modes

The oven has 9 cooking modes plus *Warm* and *Self Clean*. These use different combinations of elements and the oven fan as follows:



- True Aero. A concealed heating element surrounding the fan in the rear of the oven heats air, which is then blown into the oven cavity.



- Aero Bake. The oven fan circulates hot air from the upper outer and the bake elements.

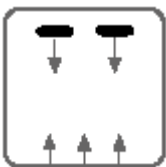

- Bake. Heat comes from the upper outer and the bake elements.



- Aero Pastry. Heat comes from the bake element and is circulated throughout the oven cavity by the oven fan.

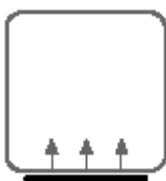

- Pastry Bake. Uses the heat from the bake element only.



- Warm. This is a constant low heat of 75 degrees C (165 degrees F) the oven fan circulates heat from the upper outer and the bake elements.

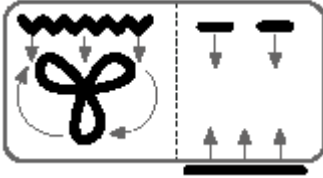

- Roast. This is a two step program where, during the first stage, the complete broil / grill element and the oven fan come on to sear the meat. The oven then automatically drops to a lower, selected temperature for the remainder of the cooking time. During this latter part of the cooking, the oven fan is off and the upper outer and the bake elements provide the heating.

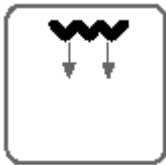

- Broil / Grill. Heat comes from the upper inner broil / grill element.

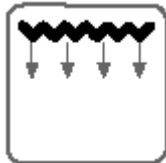

- Maxi Broil / Grill. Heat comes from both the upper inner and outer broil / grill elements.



- Aero Broil / Grill. Heat comes from both the upper inner and outer broil / grill elements and is circulated throughout the oven cavity by the oven fan.



- Self Clean. Refer to Section 2.32 for an explanation of how this function operates.

3.5 Active Vent and Cooling Fans

- The active vent fan operates in all oven modes except Warm. It extracts oven cavity air when the oven door is closed.
- The cooling fans vent air out below the oven door, they operate whenever the oven is in use. During Broil / Grill modes and Self Clean, the cooling fan runs at a higher speed to keep the oven exterior cool. (Refer to Section 2.8 for details of cooling fan speeds in various oven modes.)

3.6 *Minute Timer*

To set the timer:

1. Press TIMER. 'Timer' and the colon will flash in the clock display.
2. Rotate the PUSH TO CLEAR button to select the time needed.
3. Press TIMER or wait 8 seconds for the setting to be adopted and the timer will begin to count down.

To cancel the timer:

1. Press TIMER and PUSH TO CLEAR.
 - When the set time finishes, 'Timer' and '00:00' will flash and the timer will beep. Press TIMER or PUSH TO CLEAR to stop the beeping and clear the timer.
 - The timer does not turn the oven off.

3.7 *Set Automatic / Delayed Time Cooking*

To set Automatic/Delayed Time Cooking:

1. Check that the clock shows the correct time.
2. Select upper or lower oven cavity by pressing UPPER / LOWER (for double ovens only).
3. Press the COOK TIME button. 'Cook Time' and 'Auto' will flash and '00:00' will show in the oven display.
4. Turn the PUSH TO CLEAR knob to select the desired length of cooking time (e.g. 2 hours). The maximum cooking time that can be selected is 23 hours 59 minutes.
5. To set the time the oven is to turn off, press the STOP TIME button. 'Stop Time' and 'Auto' will flash in the oven display.
6. Set the stop time by turning the PUSH TO CLEAR button.
7. Choose the cooking mode and temperature required. These settings will automatically be adopted after 8 seconds or you can press the STOP TIME button.
 - Each of the steps in setting Automatic / Delayed Time Cooking must be started within 8 seconds of the previous step being completed, otherwise the clock display will revert to the time of day and the process will have to be started over again.
 - If there is time to wait before cooking starts, 'Delay' and 'Auto' will show in the clock display along with the current time. The oven mode and temperature displays will dim.
 - The oven mode and temperature dials will still function as in manual operation. They can be altered prior to or during cooking. The oven can be manually turned off before the set Cook Time has elapsed.
 - During cooking, 'Auto' and the remaining cook time will be shown in the clock display. When the Cook Time is finished, the oven will beep and cooking will cease. The temperature and oven mode displays will dim and 'Cook Time' and 'Auto' will flash in the clock display. If the oven mode and temperature dials are turned to OFF, the oven will revert to normal operation after 8 seconds.
 - The Automatic / Delayed Time function can be cancelled at any time by turning the temperature and oven mode dials to OFF. After 8 seconds the clock display will revert to time of day.

3.8 *Set Automatic Stop Cooking*

To set Automatic Stop Cooking:

1. Press the STOP TIME button and turn the PUSH TO CLEAR knob to display the time the oven is to switch off.
2. Choose the cooking mode and temperature. These settings will be adopted and will activate after 8 seconds.
 - 'Auto' and the remaining cooking time will show in the clock display. When the selected cooking time is finished, the oven will beep and cooking will cease. The temperature and oven mode displays will dim and 'Cook Time' and 'Auto' will flash in the clock display. If the oven mode and temperature dials are turned to OFF, the oven will revert to normal operation after 8 seconds.

3.9 *User Select Modes*

This allows the user to change some of the settings displayed on the control panel. To enter User Select mode:

1. Ensure that the oven mode and temperature dials are off and that no automatic / delayed start programs are operating.
2. Press the TIMER and then CLOCK buttons and hold down together until the oven beeps (about 2 seconds). The oven mode display (left hand one on dual ovens) will display 'User Select'.

The user select modes that can be altered are as follows:

3.10 *Sabbath Mode*

Sabbath mode is designed for religious faiths that observe a 'no work' requirement on the Sabbath. When the oven is in Sabbath mode:

- clock, temperature and oven mode displays will be disabled.
- no tones will sound.
- no error messages or temperature changes will be displayed.
- the oven cavity lights will remain in the same state (on or off) as when the Sabbath Mode is set.

To set the Sabbath mode:

1. Enter the User Select mode.
2. Turn the oven mode dial until 'Sab Mode' appears in the display.
3. Turn the PUSH TO CLEAR knob to select the length of time the oven is to be kept in Sabbath mode. The maximum is 99 hours in 1 hour steps. Turn the temperature dial to select a temperature. *Bake* is the only oven mode that can be used in Sabbath mode.
4. In double oven models, different temperatures can be selected for upper and lower cavities by using their temperature dials. The oven mode dial for the lower oven must be turned to *True Aero* to activate the oven, although it will operate in *Bake*.
5. To start Sabbath mode, press PUSH TO CLEAR. The oven mode will show 'Sab Mode' with no backlight. The temperature display will show '---'. Temperatures can be adjusted but the display will not change.
6. The oven can be turned off at any time during the Sabbath mode by turning the oven mode and temperature dials to the OFF position.
7. The oven will not revert to normal operation until the set time has elapsed. Sabbath mode can be exited at any time by pressing the PUSH TO CLEAR button for 5 seconds.

3.11 Temperature Scale

The temperatures can be displayed as either Fahrenheit or Celsius.

To change the temperature display:

1. Enter the User Select mode.
2. Turn the oven mode dial until 'Temp Scale' appears in the display.
3. Press the PUSH TO CLEAR button to select either 'C' or 'F' in the clock display.
4. Press the CLOCK button to activate.

3.12 Short Alert

By default setting, Short Alert is off and the audible beep will sound continuously at the end of cooking functions until cancelled by pressing the PUSH TO CLEAR button. When Short Alert is on, an audible beep will sound 5 times at the end of automatic cooking functions and when the timer finishes. After 5 beeps, the alert will stop, then repeat every 5 minutes until cancelled by pressing the PUSH TO CLEAR button. The clock display will flash continuously until cancelled.

To set the Short Alert:

1. Enter the User Select mode.
2. Turn the oven mode dial until 'Short Alert' appears in the display.
3. Press the PUSH TO CLEAR button to select either 'ON' or 'OFF' in the clock display.
4. Press the CLOCK button to activate.

3.13 Time Mode

The clock display can be altered to show the time in either a 12 hour or 24 hour format.

To change the clock display:

1. Enter the User Select mode.
2. Turn the oven mode dial until 'Time Mode' appears in the display.
3. Press the PUSH TO CLEAR button to select either '12H' or '24H' in the clock display.
4. Press the CLOCK button to activate.

3.14 Show Clock

This function can be used to hide the time in the clock display. All other functions, such as Timer, will continue to be shown as normal in the clock display when the time is hidden.

To hide the clock display:

1. Enter the User Select mode.
2. Turn the oven mode dial until 'Show Clock' appears in the display.
3. Press the PUSH TO CLEAR button to select either 'ON' or 'OFF' in the clock display. (Selecting 'OFF' will hide the clock display.)
4. Press the CLOCK button to activate.

3.15 Language

This can be set to display the various settings in either American English (US), English (EN), French (FR) or Spanish (SP).

To change the language setting:

1. Enter the User Select mode.
2. Turn the oven mode dial until 'Lang US' appears in the display.
3. Press the PUSH TO CLEAR button to select 'US', 'EN', 'FR' or 'SP' in the clock display.
4. Press the CLOCK button to activate.

3.16 Oven Reset

This will reset the Temperature Scale, Short Alert, Time Mode and Show Clock to the default settings. Sabbath Mode and Language settings will remain unaffected.

To reset:

1. Enter the User Select mode.
2. Turn the oven mode dial until 'Reset' appears in the display.
3. Press the PUSH TO CLEAR button to select 'OFF' in the clock display.
4. Press the CLOCK button to activate.

4. *Diagnostics*

4.1 *Entering the Sales Mode & Technician Mode*

1. Ensure all oven modes and temperature displays are set to OFF.
2. Ensure no cooking auto functions are set.
3. Enter the User Select mode by pressing and holding the TIMER button and then the CLOCK button, hold for approx. 2 seconds.
4. Turn the oven mode knob counter clockwise one position.
5. Enter Sales Mode by pressing and holding the TIMER button and then the PROBE button, hold for approx. 5 seconds.
Note: If left in Sales Mode, only the oven displays will operate.
6. Enter Technician Mode by pressing and holding the TIMER button and then the STOP TIME button. Hold for 2 seconds.
7. The Oven Mode Display will now show 'TECH SELECT'.
Note: The clock display will show the version of software installed in the product.
8. The oven is now in Technician Mode, oven diagnostics can be carried out.

4.2 *Exiting the Technician Mode*

To exit Technician Mode at any time press any button other than CLEAR or TIMER.

4.3 *Technician Mode Navigation*

1. Ensure Oven Mode Display shows 'TECH SELECT'. (Refer to Section 4.1)
2. Use the Oven Mode knob to navigate through the 19 Tech Select positions.
 - If any position from 1 to 11 is selected, then the components ON / OFF status is displayed in the oven temperature display. Push the clock twist button to turn the component ON or OFF.
 - When an element is turned ON the cavity temperature will be displayed instead of 'ON'.

Knob Position (clockwise)	Oven Mode Display		Description
	US/NZ/AUS	EU	
1	TOP INNER		Broil/Grill Element Inner.
2	TOP OUTER		Broil/Grill Element Outer.
3	FAN ELEMNT		Fan Element and Oven Fan.
4	OVEN FAN		Oven Cavity Fan.
5	THROAT ELEMNT		Throat Element.
6	LOWER ELEMNT		Bake element.
7	COOL FAN		Cooling Fan.
8	CAT ELIM		Catalytic Smoke Eliminator.
9	CAVITY LIGHT		Cavity Lights.
10	LOCK MOTOR		Lock Motor.
11	VENT FAN		Vent Fan.
12	NUM CLEAN		Number Of Pyro Cycles performed. (Number of times oven has reached 912°F (490°C))
13	CLOCK TEMP		Clock Module Temperature.
14	PWR MD TEMP		Power Module Board Temperature.
15	MAX BOARD		Maximum Temperature recorded on any Board. (Push "CLEAR" to reset value)
16	CAVITY TEMP		The Cavity Temperature measured by the sensor.
17	FAULT CODE		The two most recent Fault Codes are displayed. (Refer to Note 1)
18	NUM DAYS		Shows the number of days the product has been on.
19	DOWN LOAD		Shows that data can now be downloaded. (Press "CLEAR" to begin Smart Tool Download)

Note: When 'FAULT CODE' is selected the oven temperature display will show the two most recent fault codes in the following temperature knob positions. If 'OFF' is displayed then there are no faults logged.

Temperature Knob Position	Description
0	Most Recent Fault
1	2 nd Most Recent Fault

If the same fault occurs consecutively it will only be recorded as one fault.

If the Most Recent Fault code is cleared from the log it will then be recorded as the 2nd Most Recent Fault. The Most Recent Fault position will be left blank.

Note: To clear a fault code from the log push 'CLEAR' when it is displayed in the temperature display.

4.4 Accessing Technical Data Log

1. Enter Technician Mode. (refer to Section 4.1)
2. Choose Tech Select option 'DOWN LOAD'.
3. Hold the Fisher & Paykel "Smart Tool" up to the clock module display (top left corner) to initiate download.
4. Data can now be viewed on your PC.

4.5 Technical Data Log

The Technical Data Log has a PC interface containing several sections of information. These sections can be viewed as follows.

- **Info Section**

This section contains general identification information for the oven.

- **Current / Previous Fault Information Sections**

There are four sections displaying information on the two most recent fault codes for each oven cavity. The information contained details the oven settings, electronic board temperatures and the status of all oven outputs at the time the fault occurred.

- **Status Section**

This section details all the current user settings and the electronic software and hardware details. Also included are the following details:

- Number of times each oven cavity was self-cleaned.
- Clock module board maximum temperature.
- The day maximum temperature occurred.
- Number of days the oven has been in operation since the power-up.
- Number of times the door has been opened.

- **Function Log Section**

This section details the last ten oven modes used and the oven settings the user selected.

- **Self-Clean Log Section**

This will record the last five self-clean cycles.

The following data will be recorded when the oven cavity temperature exceeds 550°F (288°C) and a self-clean cycle is set.

- Day number the Self-Clean mode was used.
- Heat up time between 550°F (288°C) and maximum temperature.
- Maximum oven cavity temperature reached during Self-Clean.

5. *Fault Diagnostics*



5.1 *SYMPTOM: Oven electrical components are unresponsive*

POSSIBLE CAUSES:

- Clock not set after powering up
- Blown fuse
- Faulty supply wiring or connections
- Faulty power transformer
- Tripped microtemp limiter
- Faulty power module

DIAGNOSIS:

- If the clock colon: is flashing, push the clock button to set the time.
- Check the circuit breaker or fuse at the switchboard.
- Test for the correct supply voltage at the mains terminal block.
 - 120 volts in USA or 230/240 volts in NZ / AUS / EU.
- Check the power transformer by testing for 12_{VAC} on the 2-way connector into the power module (refer to Technical Overview Section 2.25). Replace if there is no 12_{VAC}.
- Check for a tripped microtemp limiter and replace if tripped. Check the other thermal limiters and trace the likely cause for tripping. (refer to Section 5.24)
- Check for a blown power module fuse by testing for 12_{VDC} between pins 1 and 6 of the 12-way clock connector on the power module. (refer to Technical Overview Section 2.25)
 - If there is no 12_{VAC} then the fuse has blown. Replace the power module. (refer to Servicing Instructions Section 7.9)

Tracing the cause of a blown power module fuse:

- Check the resistance to earth of the lamp wiring and replace if there is a short circuit. (refer to Servicing Instructions Section 7.14)
- Check the power transformer by testing for 12_{VAC} on the 2-way connector into the power module. Replace the transformer if the voltage exceeds 12_{VAC}.

5.2 SYMPTOM: Control Buttons or Clock Display not operating correctly or unresponsive

POSSIBLE CAUSES:

- Loose connection to the power module
- Faulty clock module assembly
- Lens has come loose from adhesive
- Faulty power module

DIAGNOSIS:

- If one of the clock display segments is flashing or is showing a warning then refer to the user guide for warning identification.
- If one or more buttons are unresponsive, check all buttons to ensure they are not held down or jammed by the front panel and reassemble if required.
- If a clock segment or icon appears to be staying on or not lighting, replace the clock module. (refer to Servicing Instructions Section 7.8)

5.3 SYMPTOM: Temperature or Oven Mode Switch Module is jammed or loose

POSSIBLE CAUSES:

- Assembly is incorrect
- Switch has failed

DIAGNOSIS:

- Check the switch module is assembled correctly and reassemble if required. (refer to Servicing Instructions Section 7.6)
- Replace the switch module if the fault can't be rectified. (refer to Servicing Instructions Section 7.6)

5.4 SYMPTOM: Incorrect Temperature or Oven Mode display at correct switch position

POSSIBLE CAUSES:

- Switch module is assembled incorrectly
- Switch module is faulty

DIAGNOSIS:

- Check the switch module is correctly assembled and reassemble if required. (refer to Servicing Instructions Section 7.6)
- Check all connections to the switch and clock modules.
- Replace the switch module if there are no connection faults. (refer to Servicing Instructions Section 7.6)

5.5 SYMPTOM: Faulty Temperature or Oven Mode L.C.D. Modules

POSSIBLE CAUSES:

- Loose connection to the clock module
- Faulty temperature or oven mode L.C.D. module

DIAGNOSIS:

- If the fault is that one segment of the display is always on or always off, replace the L.C.D. Module. (refer to Servicing Instructions Section 7.7)
- If the L.C.D. module is displaying incorrect information, check the connections from the L.C.D. module to the clock and switch modules. If there are no connection faults, replace the L.C.D. module.
- Replace the switch module if no other faulty components can be found. (refer to Servicing Instructions Section 7.6)

5.6 SYMPTOM: “DOORLOCK” and “PROBE” showing for lower cavity (double oven only)

POSSIBLE CAUSES:

- Lower cavity power module has no power

DIAGNOSIS:

- Check the connection between upper and lower cavity power modules.
- Test for the correct supply voltage to the lower cavity power transformer.
 - 120volts in USA or 230/240 volts in NZ / AUS / EU
- Check the connection from the power transformer to the lower cavity power module.
- Check for a blown power module fuse by testing for 12V_{DC} between pins 1 and 6 of the 12-way clock connector on the power module. (refer to Technical Overview Section 2.25)
 - If there is no 12V_{AC} then the fuse has blown. Replace the power module. (refer to Servicing Instructions Section 7.9)

Tracing the cause of a blown power module fuse:

- Check the resistance to earth of the lamp wiring and replace if there is a short circuit. (refer to Servicing Instructions Section 7.14)
- Check the power transformer by testing for 12V_{AC} on the 2-way connector into the power module. Replace the transformer if the voltage exceeds 12V_{AC}.

5.7 ***SYMPTOM: Oven Under Cooking***

POSSIBLE CAUSES:

- Incorrect oven use
- Incorrect temperature scale used
- Faulty temperature sensor
- Faulty oven element
- Faulty oven cavity fan
- Blown thermal limiter
- Faulty power module

DIAGNOSIS:

- Check that the oven is being operated correctly. (check the oven Use & Care Guide for troubleshooting tips)
- Ensure the oven door closes and seals correctly.
- Ensure the correct temperature scale has been set. (°F or °C).
- Check that the correct oven mode has been selected. (the F&P Smart tool can be used to view previous oven modes used, refer to Diagnostics Section 4.4).
- Check for temperature sensor faults. (refer to Section 5.23)
- Check for tripped thermal limiters. (refer to Section 5.24)
- Check for oven element faults. (refer to Section 5.22)
- Check for oven cavity fan faults. (refer to Section 5.20)
- Replace the power module if no other faulty components can be found. (refer to Servicing Instructions Section 7.9)

5.8 ***SYMPTOM: Baking burns on the top***

POSSIBLE CAUSES:

- Incorrect oven use
- Incorrect temperature scale used
- Faulty temperature sensor
- Faulty oven element
- Faulty oven cavity fan
- Faulty power module

DIAGNOSIS:

- Check that the oven is being operated correctly. (check the oven Use & Care Guide for troubleshooting tips)
- Ensure the correct temperature scale has been set. (°F or °C).
- Check that the correct oven mode has been selected. (the F&P Smart tool can be used to view previous oven modes used, refer Diagnostics Section 4.5)
- Check for temperature sensor faults. (refer to Section 5.23)
- Check for oven element (mainly upper elements) faults. (refer to Section 5.22)
- Check for oven cavity fan faults. (Refer to Section 5.20)
- Replace the power module if no other faulty components can be found. (refer to Servicing Instructions Section 7.9)

5.9 SYMPTOM: *Baking burns on the bottom*

POSSIBLE CAUSES:

- Incorrect oven use
- Incorrect temperature scale used
- Faulty temperature sensor
- Faulty oven element
- Faulty oven cavity fan
- Faulty power module

DIAGNOSIS:

- Check that the oven is being operated correctly. (check the oven Use & Care Guide for troubleshooting tips)
- Ensure the correct temperature scale has been set (°C or °F)
- Check that the correct oven mode has been selected. (the F&P Smart tool can be used to view previous oven modes used, refer to Diagnostics Section 4.5)
- Check for temperature sensor faults. (refer to Section 5.23)
- Check for oven element faults (mainly bake element). (refer to Section 5.22)
- Replace the power module if no other faulty components can be found. (Refer to Servicing Instructions Section 7.9)

5.10 SYMPTOM: *Oven seems to be functioning normally but does not heat*

POSSIBLE CAUSES:

- Oven is in Sales Mode (Refer to Section 4.0 Diagnostics).
- Faulty oven door switch or door not closed
- Tripped thermal limiter
- Faulty temperature sensor
- Faulty oven element
- Faulty power module

DIAGNOSIS:

- Check to see if the door switch is operating correctly. (refer to Section 5.25)
- Check for tripped thermal limiters. (refer Section 5.24)
- Check for temperature sensor faults. (refer to Section 5.23)
- Check for oven element faults. (refer to Section 5.22)
- Replace the power module if no other component faults can be found. (refer to Servicing Instructions Section 7.9)

5.11 SYMPTOM: Oven heats slowly or fails to reach preset temperature

POSSIBLE CAUSES:

- Incorrect oven use
- Faulty door switch
- Low supply voltage
- Faulty temperature sensor
- Faulty oven element / fan
- Faulty power module

DIAGNOSIS:

- Ensure the oven door closes and seals correctly.
- Check for door switch faults. (refer to Section 5.25)
- Check for temperature sensor faults. (refer to Section 5.23)
- Check for oven element faults. (refer to Section 5.22)
- Replace the power module if no other component faults can be found. (Refer to Servicing Instructions Section 7.9)

5.12 SYMPTOM: Oven Lights do not turn On / Off

POSSIBLE CAUSES:

- Blown oven light bulb/s
- Faulty oven door switch
- Faulty wiring
- Faulty power module

DIAGNOSIS:

- Replace bulb/s if faulty.
- If lights do not turn off, check for oven door switch faults. (refer to Section 5.25)
- Check for oven light faults. (refer to Section 5.21)
- Replace the power module if no other component faults can be found. (refer to Servicing Instructions Section 7.9)

5.13 SYMPTOM: Fault Code F1 displayed in Tech Select only (Refer to 4.0 Diagnostics)

CAUSE:

Maximum allowable temperature (185°F, 85°C) around electronics was exceeded.

DIAGNOSIS:

- Check for cooling fan faults or vent blockages. (refer to Section 5.19)

5.14 SYMPTOM: Fault Code F2 displayed

CAUSE:

Maximum allowable cavity temperature was exceeded during Self-Clean Cycle.

DIAGNOSIS:

- Check for temperature sensor faults. (refer to Section 5.23)
- Check for oven element faults. (refer to Section 5.22)
- Replace the power module if no other component faults can be found. (refer to Servicing Instructions Section 7.9)

5.15 SYMPTOM: Fault Code F3 displayed

CAUSE:

The oven temperature was sensed at over 600°F (315°C) during normal cooking operation.

DIAGNOSIS:

- Check for temperature sensor fault. (refer to Section 5.23)
- Check for oven element faults. (refer to Section 5.22)
- Replace the power module if no other component faults can be found. (refer to Servicing Instructions Section 7.9)

5.16 SYMPTOM: Fault Code F4 displayed

CAUSE:

A fault occurred in the power module.

PROCEDURE:

- Check all the connections to the power module and clock module.
- If the fault code re-occurs, replace the power module. (refer to Servicing Instructions Section 7.9)

5.17 SYMPTOM: Fault Code F5 displayed

CAUSE:

A communications error occurred between the clock module and the power module.

DIAGNOSIS:

- Check the connections between the power module and clock module.
- If the fault code re-occurs, replace the power module. (refer to Servicing Instructions Section 7.9)

5.18 SYMPTOM: Fault Code F7 displayed

CAUSE:

A fault occurred with the oven door lock.

DIAGNOSIS:

- Check that the oven door lock has not jammed. (refer to Servicing Instructions Section 7.24)
- Check for oven door switch and door lock switch faults. (refer to Section 5.25)
- Check for temperature sensor faults. (refer to section 5.23)
- Replace the power module if no other component faults can be found. (refer to Servicing Instructions Section 7.9)

5.19 Tracing Cooling Fan Faults

(Refer to Technical Overview Section 2.8)

PROCEDURE:**If the cooling fan will not start**

1. Enter Technician Mode diagnostics to test the cooling fan operation. (refer to Diagnostics Section 4.3)
 - The cooling fan will operate at low speed in normal operation. When the cooling fan is turned on in diagnostics it will run at high speed.
2. Test for the correct voltage across the cooling fan contacts or substitute the fan with a dummy load. Replace the fan if tests are good. (refer to Servicing Instructions Section 7.16)
3. Check the fan wiring continuity back to the power module.
 - If the wiring continuity is good then it is likely that the cooling fan is not faulty. (refer to Symptom Procedure Checklist for further component tests)

If the cooling fan will not turn off

1. Check for temperature sensor faults. (refer to Section 5.23)
 - The cooling fan will operate at low speed until the cavity temperature is below 300°F (150°C). If the cavity temperature is above 520°F (270°C) the cooling fan will operate at high speed.
2. Replace the power module if no other component faults can be found, the cooling fan triac may be faulty. (refer to Servicing Instructions Section 7.9)

5.20 Tracing oven cavity fan faults

(Refer to Technical Overview Section 2.7)

PROCEDURE:

If oven cavity fan will not operate

1. Enter Technician Mode diagnostics to test the oven cavity fan operation. (refer to Diagnostics Section 4.3)
2. If the oven cavity fan operates in diagnostics but not in normal operation. Check for door switch faults. (refer to Section 5.25)
3. Test for 230/240volts across contacts or substitute the fan with a dummy load. Replace the fan if tests are good. (refer to Servicing Instructions Section 7.18)
4. Check the continuity of the fan wiring circuit back to power module including thermal limiters and the isolating relay.

Note: The isolating relay is only energised when an oven mode is selected.

5. If the wiring continuity is good, then it is likely that the oven cavity fan is not faulty. (refer to Symptom Procedure Checklist for further component tests)

If the oven cavity fan will not turn off

1. Replace the power module if no other component faults can be found, the cooling fan triac may be faulty. (refer to Servicing Instructions Section 7.9)

5.21 Tracing oven light faults

(Refer to Technical Overview Section 2.17)

PROCEDURE:

If light bulb is faulty

1. Replace halogen bulb. (refer to Servicing Instructions Section 7.13)

If all the lights will not turn on or replacing the bulb/s did not fix the problem.

1. Check the continuity of the light wiring back to power module. (refer to Technical Overview Section 2.25 for light connector location)
 - Replace the lamp assembly if there is no continuity. (refer to Servicing Instructions Section 7.14)
2. Check power module light connector for 12_{VAC}, across pins 1&2 and 1&3. (refer to Technical Overview Section 2.25)
 - Replace the lamp assembly if 12_{VAC} is present. (refer to Servicing Instructions Section 7.14)
3. If there is not 12_{VAC} across the light connector, check for 12_{VAC} supply from the transformers and correct power supply from the switchboard.
 - Replace the power module if the transformers and supply power voltages are correct. (refer to Servicing Instructions Section 7.9)

Note: If the wiring continuity is good and 12_{VAC} is present it is likely that the oven lights are not faulty. (refer to Symptom Procedure Checklist for further component tests)

If the lights do not turn off

1. Check to see if the door switch is faulty by selecting an Aero Oven Mode and leaving the door open. If the oven cavity fan starts after eight seconds, the switch is faulty.
 - If the faulty door switch cannot be easily repaired, replace the door lock assembly. (refer to Servicing Instructions Section 7.25)

5.22 Tracing element faults

(Refer to Technical Overview Section 2.10-2.15 & 2.33)

PROCEDURE:

If the element does not turn off (element run-away)

Note: In normal operation the element will cycle (turn on & off) when the cavity temperature has reached the set point. This can be detected by listening for the switching noise of the element relay switch on the power module or using a current meter.

1. Check the temperature sensor is reading the correct temperature. (refer to Section 5.23)
2. If the correct temperature is being read, isolate the supply and check that all the elements are wired correctly and the element relay switches haven't shortcircuited.

If the element does not heat up

Note: Before testing refer to Technical Overview Sections 2.10-2.15 & 2.33 to find out which elements are used for each oven mode.

1. Check for a tripped thermal limiter. (refer to section 5.24)
2. Test the element operation in Technician Mode. (refer to Diagnostics Section 4.3)
3. If the element does not heat up in Technician Mode, test the resistance of the element. The appropriate range of resistance for each element is given in Table 5.22 below. Replace the element if its resistance is outside the given range.

Element	Min Resistance (Ω)	Max Resistance (Ω)
Upper Inner	19	23
Upper Outer	35	50
Lower	34	47
Fan	21	26
Throat	77	218
Catalytic Converter	300	600

Table 5.22

4. Check the continuity of the element wiring back to the power module, including the thermal limiters and the isolating relay.
Note: The isolating relay is only energised when an oven mode is selected.
5. If the wiring continuity is good, it is likely that the element is not faulty. (refer to Symptom Procedure Checklist for further component tests)

5.23 Tracing oven temperature sensor faults

(Refer to Technical Overview Section 2.16)

PROCEDURE:

1. Enter the Technician Mode diagnostics to view the cavity temperature reading. (refer to Diagnostics Section 4.3)
2. Record the cavity temperature reading and substitute the oven temperature sensor with a new sensor. (refer to Servicing Instructions Section 7.12)
3. Record the cavity temperature reading from the new sensor.
 - If there is a significant difference between the two temperature readings ($>10^{\circ}\text{F}$ or $>5^{\circ}\text{C}$), leave the new sensor in.
4. If the two temperature readings are similar ($\pm 10^{\circ}\text{F}$ or $\pm 5^{\circ}\text{C}$) check the temperature sensor wiring connectors and connection to the power module.
 - If the wiring is good, refit the original temperature sensor. It is likely the temperature sensor is not faulty.
5. If the fault persists, test the power module by substituting a 1000 ohm 5% resistor across pins 1&2 on the 'Sensors' connector. (refer to Technical Overview Section 2.25 for pin numbering) The temperature display should read $32^{\circ}\text{F} \pm 10^{\circ}\text{F}$ ($0^{\circ}\text{C} \pm 5^{\circ}\text{C}$).
 - Replace the power module if the displayed reading is incorrect. (refer to Servicing Instructions Section 7.9)

5.24 Tracing thermal limiter faults

(Refer to Technical Overview Section 2.28)

Note: In the event of a thermal limiter tripping, it is important that the cause be located and rectified.

PROCEDURE:

1. Do a continuity test between L2 (for US products), Neutral (for NZ/AUS products) or P2 (for EU products) and the terminal block side of the isolating relay.
 - If there is no continuity then this indicates a thermal limiter has tripped.

Note: To do a quick check for a tripped microtemp limiter test for 12V_{AC} on the 2 way connector into the power module from the transformer. (refer to Technical Overview Section 2.25)
2. To locate the tripped thermal limiter check for continuity across the limiter contacts.

Note: (EU products only) Check for continuity across both paths of the 2 pole limiter.
3. Replace the faulty thermal limiter/s with one having the same trip temperature. (refer to Servicing Instructions Section 7.11)
4. Trace the component that is most likely to have caused the thermal limiter to trip.

To trace the likely cause of tripping

1. Determine the likely faulty component.
2. Trace the component fault.

Note: Thermal limiters are positioned in specific areas to detect certain components failing. The limiter positions and the components they monitor are listed in the Technical Overview Section 2.28.

These are the most likely causes of a thermal limiter tripping:

- Faulty cooling fan (stopped running). Refer to Section 5.19
- Faulty element (element run-away). Refer to Section 5.22
- Faulty temperature sensor (incorrect reading) Refer to Section 5.23

5.25 Tracing oven door switch and door lock switch faults

(Refer to Technical Overview Section 2.31)

PROCEDURE:

Oven Door Switch

1. Push the door switch plunger in and out to ensure it is operating correctly.
2. Check to see if the door switch is faulty by holding the switch in for eight seconds. If the oven lights switch OFF then the door switch is not faulty.
3. If the oven lights do not switch ON and OFF then check the wiring continuity between the door lock assembly and the power module.
4. If the wiring continuity is good, replace the door lock assembly. (refer to Servicing Instructions Section 7.23)

Door Lock Switches

- Test to ensure the lock switch is switching properly.
1. Use a multimeter to check that the door lock switch readings back to the power module are correct. When the door is not locked, Lock Switch 1 inputs should be short circuit and Lock Switch 2 inputs should be open circuit. (The readings are vice-versa when the door is locked.)

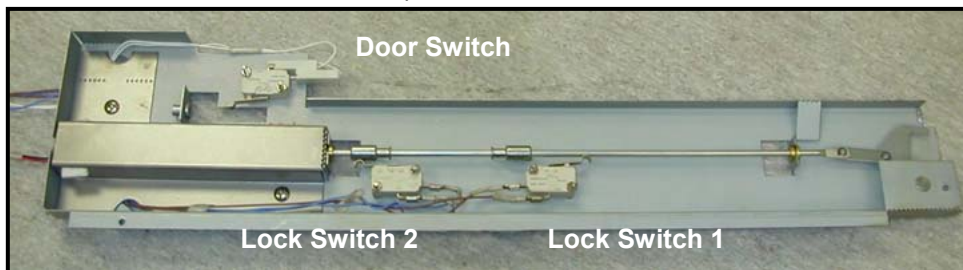

Figure 5.25

2. Check the continuity and insulation resistance of the lock switch wiring
 - Replace the door lock assembly if a wiring continuity/insulation resistance fault cannot be repaired. (refer to Servicing Instructions Section 7.23)
 - If the wiring continuity and insulation resistances are good, it is likely that these switches are not faulty. (refer to Symptom Procedure Checklist for further component tests)

5.26 Determining which power module is faulty in a double oven (F4 or F5 Fault Codes)

(Refer to Technical Overview Section 2.25)

- Set up the double oven as if it were a single oven so that the faulty power module can be eliminated.

PROCEDURE:

For Upper Cavity power module:

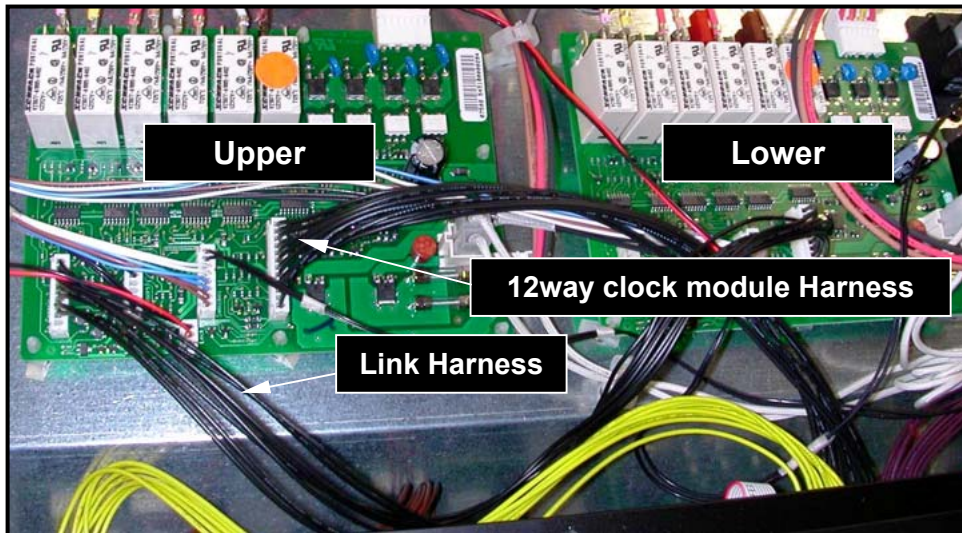

Figure 5.26

- Unplug the purple harness from the clock module.
- Remove the link harness to the lower cavity power module.
 - The clock module now assumes there is only one power module. The second power module will run in a powered but disabled mode (elements will not operate).
- Try to operate the upper cavity. If the fault code reappears then the upper cavity power module is faulty and needs to be replaced. (refer to Servicing Instructions Section 7.9)

For US products only

- If the fault code does not reappear, then the lower power module is faulty and needs to be replaced.

For NZ/AUS and EU products only

- If the fault code does not reappear, check the lower power module for faults.
- Disconnect the clock module from the upper cavity power module at the power module end of the black 12 way harness.
 - Disconnect the link harness between the upper and lower cavity power modules.
 - Plug the clock module harness into the link harness connection on the lower cavity power module.
 - Try to operate the lower cavity using the upper cavity controls.
 - If the fault code reappears then the lower cavity power module is faulty and needs to be replaced. (refer to Servicing Instructions Section 7.9)

6. Wiring Diagrams

6.1 Double Oven USA Wiring Schematic

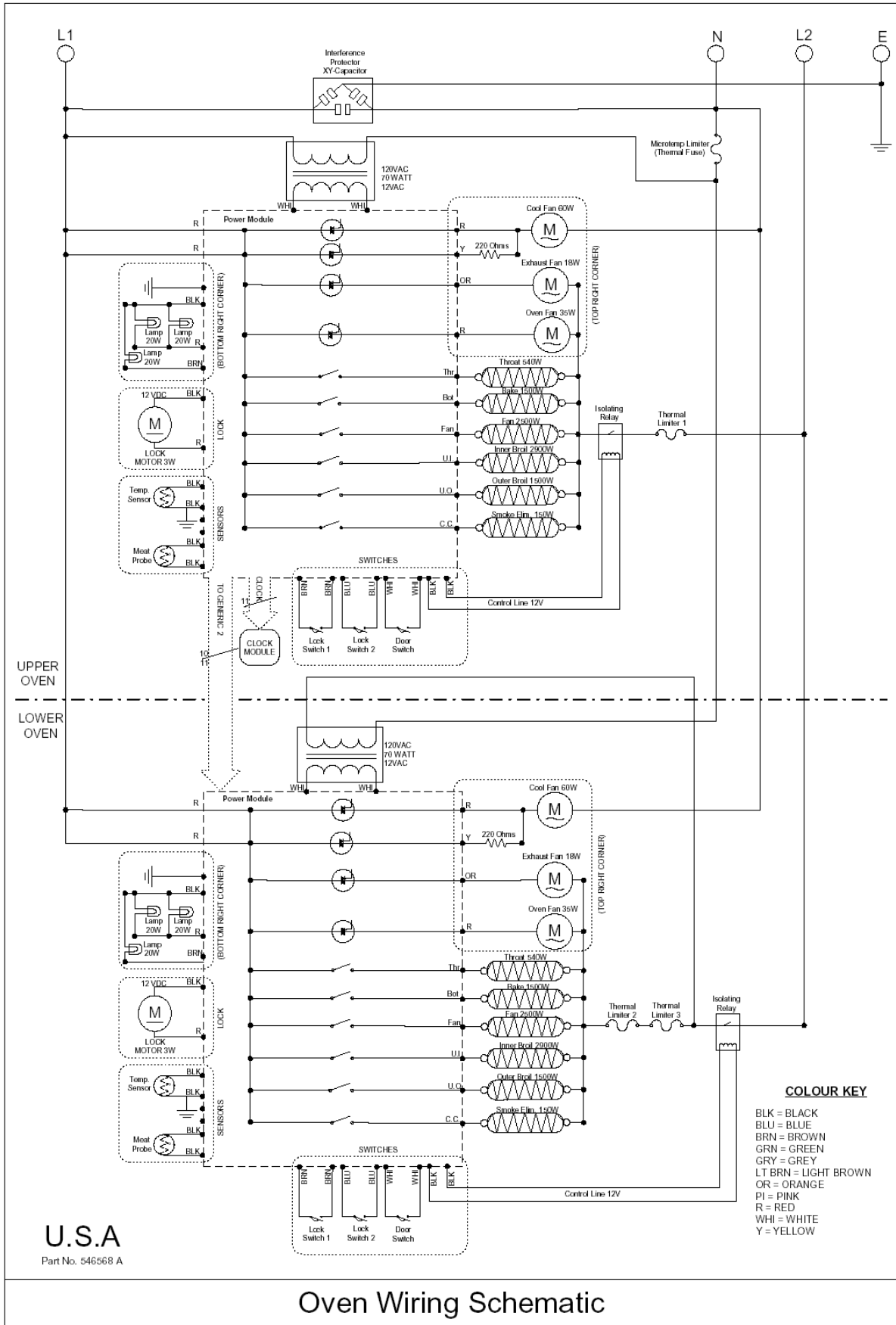

6.2 Single Oven USA Wiring Schematic

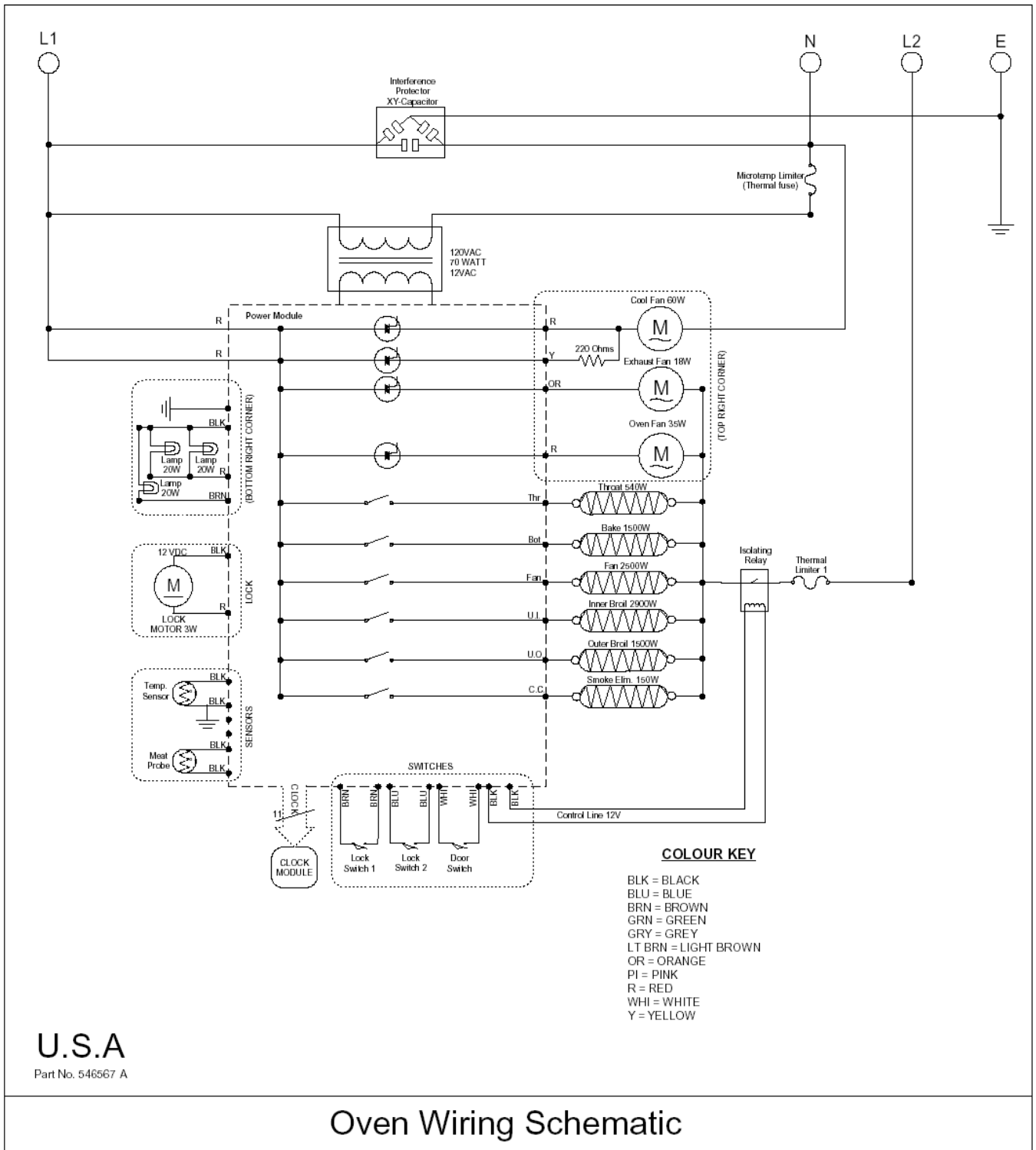

6.3 Double Oven NZ / AUS Wiring Schematic

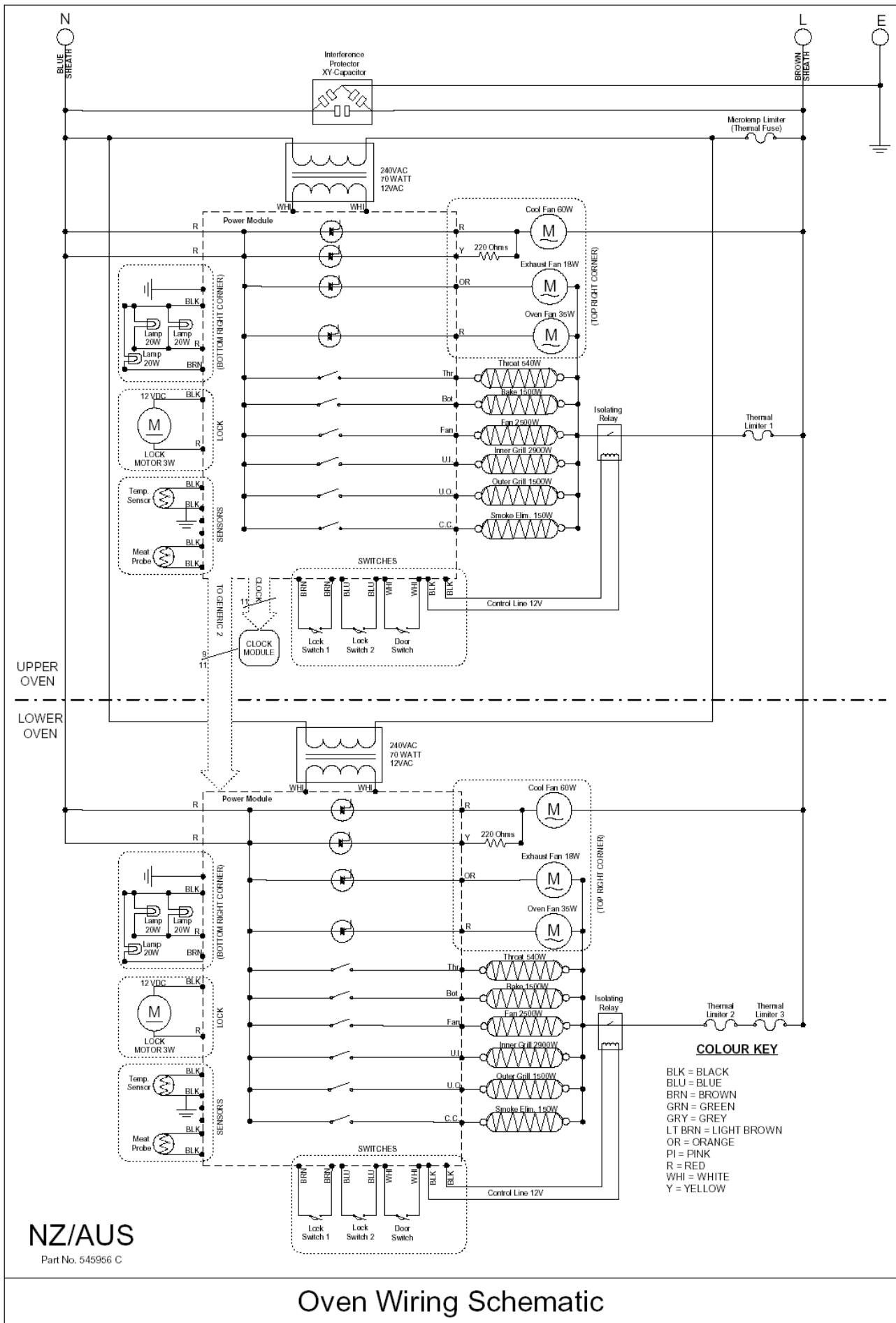

6.4 Single Oven NZ / AUS Wiring Schematic

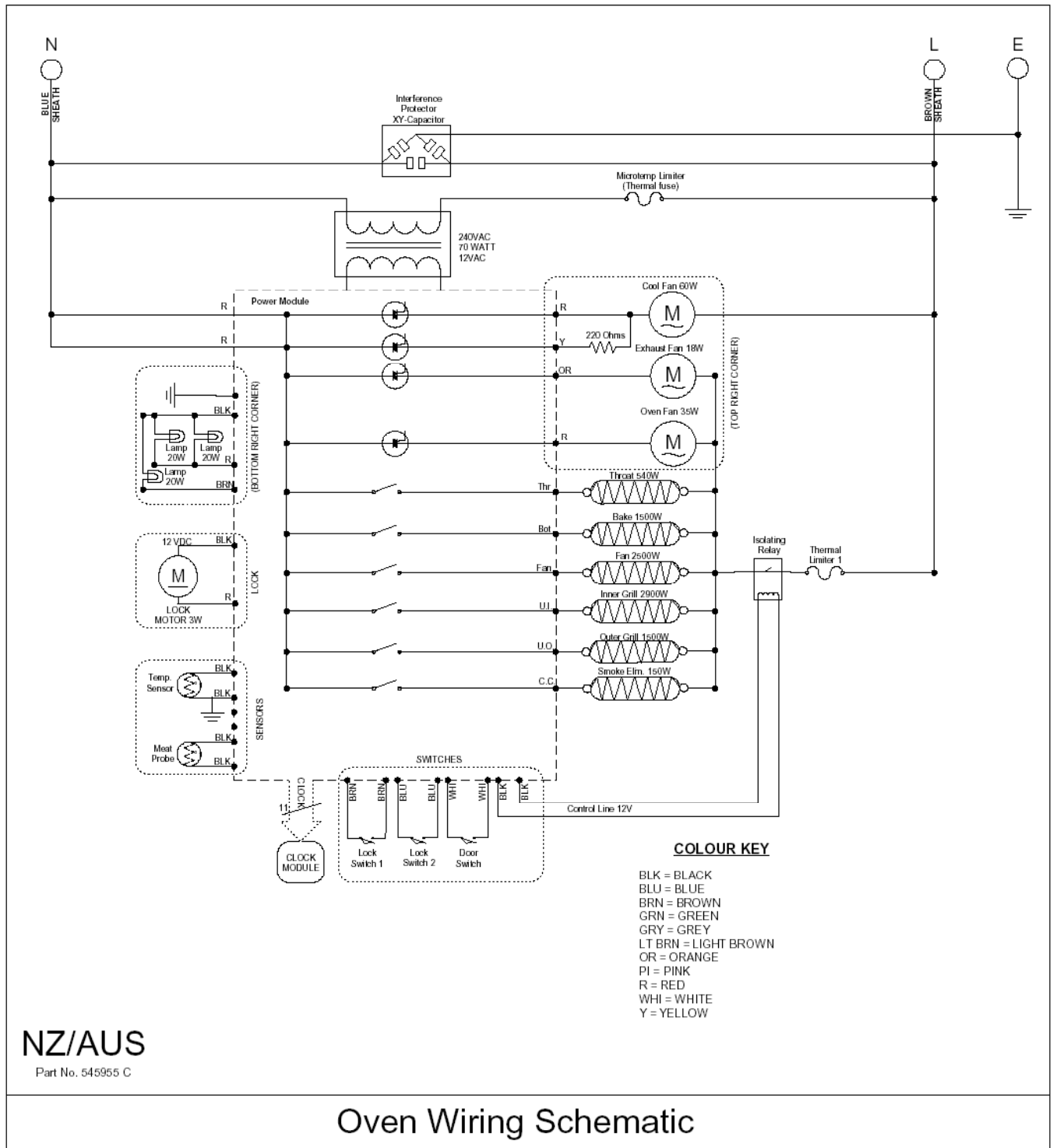

6.5 Double Oven EU Wiring Schematic

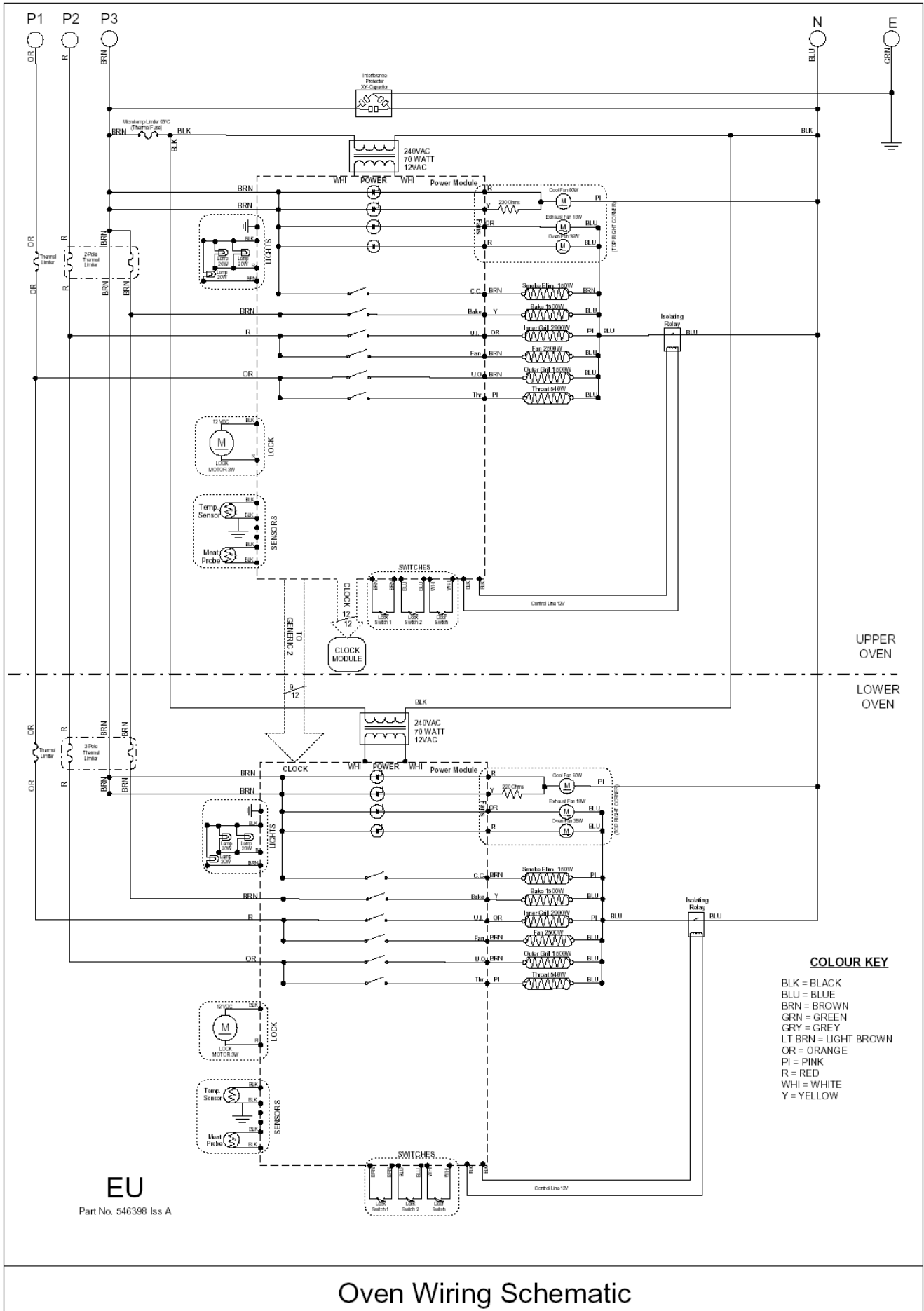

6.6 Single Oven EU Wiring Schematic

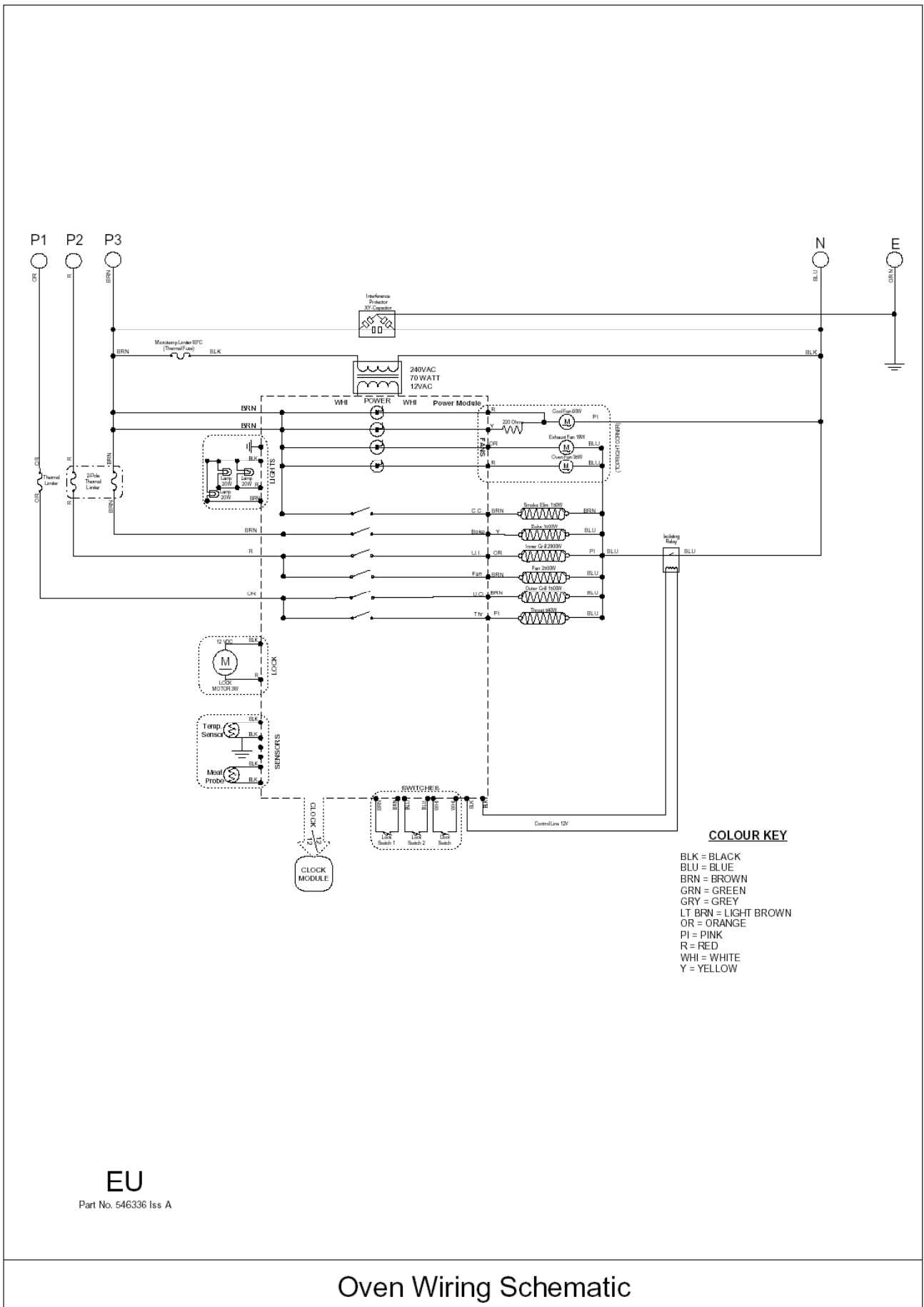

7. Service Procedures

In order to service components of the oven, certain procedures must be followed. These procedures are as follows:

- To avoid stripping screws do not over tighten when reassembling parts. If using a screw gun have the torque setting on low.
- Take extra care not to damage wire terminals on removal as some have release clips.

7.1 Removal from Joinery Cavity



1. Disconnect the unit from the power supply.
2. Remove the oven doors, shelves and utensils. (refer to Section 7.21)
3. Remove the two screws on either side of the oven frame that secure the oven to the joinery.
4. Slide the oven out of the cavity onto a suitable support.

Warning: This oven is heavy and care should be taken to use correct lifting techniques.

Reassembly

- Refit in reverse manner

7.2 Components in Control Panel Area



1. Remove the oven from the joinery cavity. (refer to Section 7.1)

Warning: To avoid the oven tipping forward, remove the shelves, utensils and doors. (refer to Section 7.21)

Note: The oven does not need to be removed completely from the joinery cavity. Sliding the oven out eight inches (200mm) will give sufficient access space.

2. Detach the control panel from the frame uprights by removing the two screws located either side of the rear of control panel.
3. Remove the wiring harness from the power module.
4. Lift the control panel off the two support brackets.
 - The function, temperature and clock modules are now accessible.

Reassembly

- Refit in reverse manner.

7.3 *Components in Back Panel Area*



1. Remove the oven from the joinery cavity. (refer to Section 7.1)
2. Remove the six rear-most screws on the top panel.
3. Remove the two screws fixing the cable connector panel to the back panel.
4. Remove the back panel screws and lift off the back panel.
 - Components at the back of the oven will now be accessible.

Reassembly

1. Refit in reverse manner.
2. Follow the reassembly procedure. (refer to Section 7.5)

7.4 *Components in Service Panel Area*



1. Remove from the joinery cavity. (refer to Section 7.1)

Warning: To avoid the oven tipping forward, remove shelves, utensils and doors. (refer to Section 7.21)

Note: The oven does not need to be removed completely from the joinery cavity. Sliding the oven out 8 inches (200mm) will give sufficient access space.

2. Remove the two screws fixing the service panel to the side panels.
3. Lift off the service panel.
 - The power module and other electronic components will now be accessible.

Reassembly

- Refit in reverse manner.
- Follow the reassembly procedure. (refer to Section 7.5)

7.5 *Reassembly Procedure*



1. After repairing or replacing components, ensure that all wiring terminals are correct and tight. Restore power and test repaired or replaced components. (refer to Diagnostics Section 4.3)
2. Disconnect the power supply and refit panels.
3. Slide the oven back into the joinery cavity and refit the four securing screws.
4. Refit the oven doors, shelves and utensils.
5. Restore the power, reset the clock and check the oven modes.

7.6 *Function and Temperature Switch Modules*



Location: Control Panel

Removal

1. Follow the general servicing instructions for components around the control panel area. (refer to Section 7.2)
2. Remove the temperature/oven mode knobs and the clock twist button.

Note: To best work on the control panel turn it face down and place blocks of polystyrene under the ends to elevate it off the working surface.

3. Disconnect the earth wire and remove the mounting panel.
4. Remove the retaining nut and washer from the faulty module.
5. Disconnect the wiring harness and transfer to the replacement module.
6. Remove the plastic mounting bracket from the faulty module and transfer it to the replacement module.

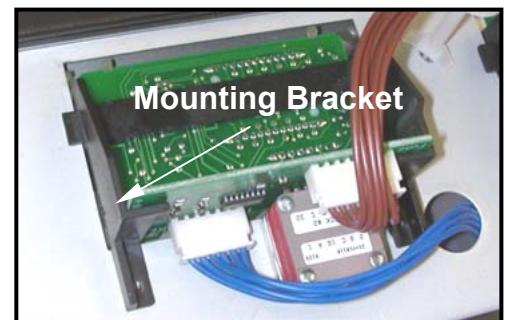

Figure 7.6

Reassembly

- Refit in reverse manner.

Note: Ensure the wiring harness wires are clear of possible crush points during reassembly.

- Follow the reassembly procedure. (refer to Section 7.5)

7.7 *Function and Temperature L.C.D. Modules and Lenses*



Location: Control Panel

L.C.D Modules:

Removal

1. Follow the general servicing instructions for components around the control panel area. (refer to Section 7.2)
2. Remove the temperature/oven mode knobs and the clock twist button.
3. Disconnect the earth wire and remove the mounting panel.
4. Unclip the faulty module from the retaining lens and lift out.
5. Disconnect the wiring harness and transfer it to the replacement module.

Note: Take care not to leave fingerprints or visible marks on any lens surface.

Reassembly

1. Remove the protective strip from the L.C.D module screen.
2. Refit in reverse manner.

Note: Ensure the wiring harness wires are clear of possible crush points when reassembling.

- Follow the reassembly procedure. (refer to Section 7.5)

L.C.D Lenses:

Removal

1. Follow the procedure for removal of L.C.D modules above to step 4.
2. Remove the damaged lens and clean the old adhesive strip area.
3. Remove the adhesive tape backing strip from the replacement lens.
4. Remove the protective strip from the replacement L.C.D lens and attach it ensuring it is fitted squarely.

Note: Take care not to leave fingerprints or visible marks on any lens surface.

Reassembly

- Refit in reverse manner.

Note: Ensure the wiring harness wires are clear of possible crush points when reassembling.

- Follow the reassembly procedure. (refer to Section 7.5)

7.8 Clock Module or Buttons



Location: Control Panel

Removal

1. Follow the general servicing instructions for components around the control panel area. (refer to Section 7.2)
2. Remove the temperature/oven mode knobs and the clock twist button.
3. Disconnect the earth wire and remove the mounting panel.
4. Disconnect the wiring harness and transfer to the replacement clock module or replace the button assembly.
5. If replacing the clock module, remove the protective strip from screen.

Note: Take care not to leave fingerprints or visible marks on any lens surface.

Reassembly

- Refit in reverse manner.

Note: Ensure the wiring harness wires are clear of possible crush points when reassembling.

- Follow reassembly procedure. (refer to Section 7.5)

7.9 Power Module



Location: Under the service panel

Removal

1. Follow the general servicing instructions for components around the service panel area. (refer to Section 7.4)
2. Remove all wires and wire harnesses and transfer them to the replacement power module. (refer to Technical Overview Section 2.25)

Note: Label the relay switch wires before removing them to ensure the correct connections are made to the replacement power module.

3. Lift the power module off the seven P.C.B stand-offs.

Note: Use a small pair of needle-nose pliers to force in the plastic barbs on the P.C.B stand-offs in order to lift the board up.

Re-assembly

- Refit in reverse manner.
- Follow the reassembly procedure. (refer to Section 7.5)



Figure 7.9g

Single/Double Upper Element Relays, NZ/AUS

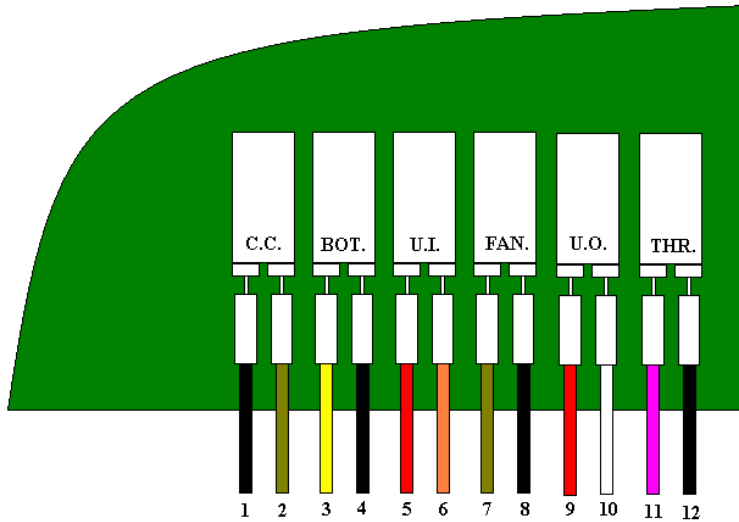

DESCRIPTION

- THR. Throat
- U.O. Upper Outer (Outer Grill)
- FAN. Convection Fan
- U.I. Upper Inner (Inner Grill)
- BOT. Bottom (Concealed Bake Element)
- C.C. Catalytic Converter (Smoke Eliminator)

WIRE COLOUR

- 1. Black
- 2. Light Brown
- 3. Yellow
- 4. Black
- 5. Red
- 6. Orange
- 7. Light Brown
- 8. Black
- 9. Red
- 10. White
- 11. Pink
- 12. Black

Figure 7.9a

Lower Element Relays, NZ/AUS

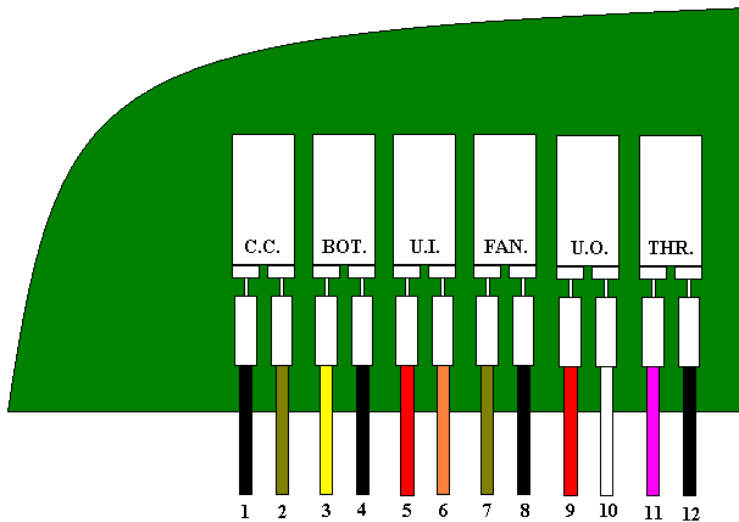

DESCRIPTION

- THR. Throat
- U.O. Upper Outer (Outer Grill)
- FAN. Convection Fan
- U.I. Upper Inner (Inner Grill)
- BOT. Bottom (Concealed Bake Element)
- C.C. Catalytic Converter (Smoke Eliminator)

WIRE COLOUR

- 1. Black
- 2. Light Brown
- 3. Yellow
- 4. Black
- 5. Red
- 6. Orange
- 7. Light Brown
- 8. Black
- 9. Red
- 10. White
- 11. Pink
- 12. Black

Figure 7.9b

Single/Double Upper Element Relays, US

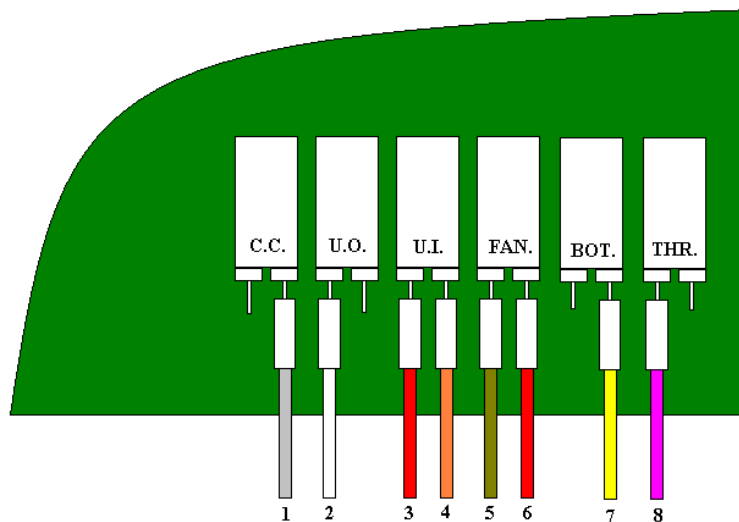

DESCRIPTION

- THR. Throat
- BOT. Bottom (Concealed Bake Element)
- FAN. Convection Fan
- U.I. Upper Inner (Inner Grill)
- U.O. Upper Outer (Outer Grill)
- C.C. Catalytic Converter (Smoke Eliminator)

WIRE COLOUR

- 1. Grey
- 2. White
- 3. Red
- 4. Orange
- 5. Light Brown
- 6. Red
- 7. Yellow
- 8. Pink

Figure 7.9c

Lower Element Relays, US

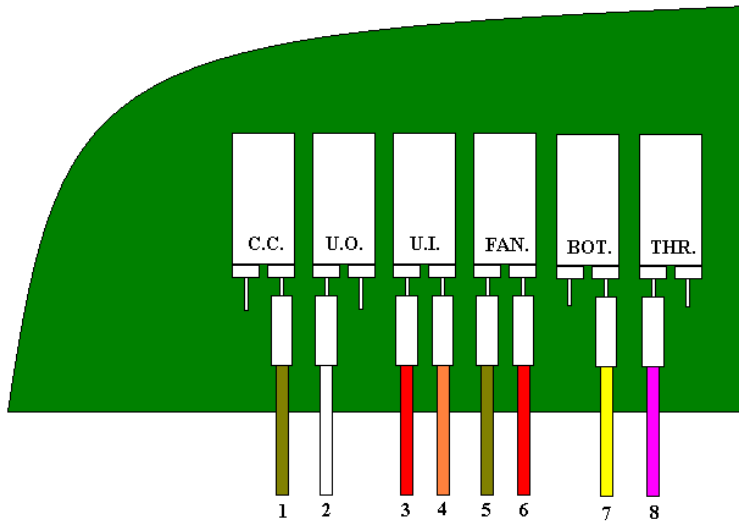

DESCRIPTION

- THR. Throat
- BOT. Bottom (Concealed Bake Element)
- FAN. Convection Fan
- U.I. Upper Inner (Inner Grill)
- U.O. Upper Outer (Outer Grill)
- C.C. Catalytic Converter (Smoke Eliminator)

WIRE COLOUR

- 1. Light Brown
- 2. White
- 3. Red
- 4. Orange
- 5. Light Brown
- 6. Red
- 7. Yellow
- 8. Pink

Figure 7.9d

Single/Double Upper Element Relays, EU

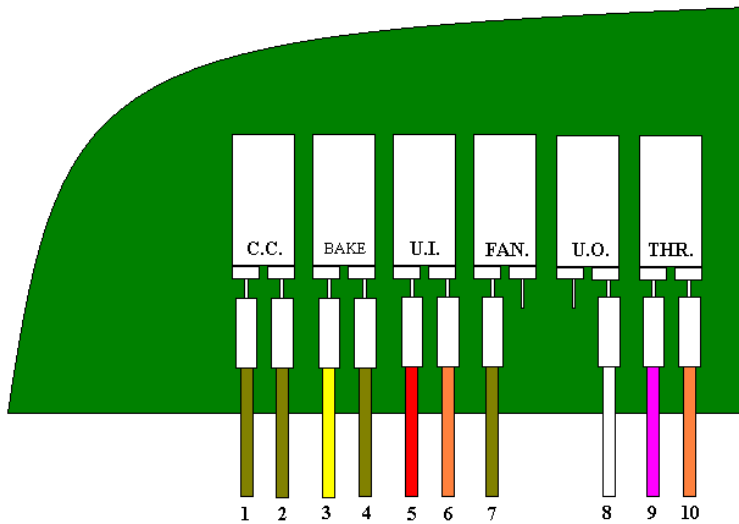

DESCRIPTION

- THR. Throat
- U.O. Upper Outer (Outer Grill)
- FAN. Convection Fan
- U.I. Upper Inner (Inner Grill)
- BAKE Bottom (Concealed Bake Element)
- C.C. Catalytic Converter (Smoke Eliminator)

WIRE COLOUR

- 1. Light Brown
- 2. Light Brown
- 3. Yellow
- 4. Light Brown
- 5. Red
- 6. Orange
- 7. Light Brown
- 8. White
- 9. Pink
- 10. Orange

Figure 7.9e

Lower Element Relays, EU

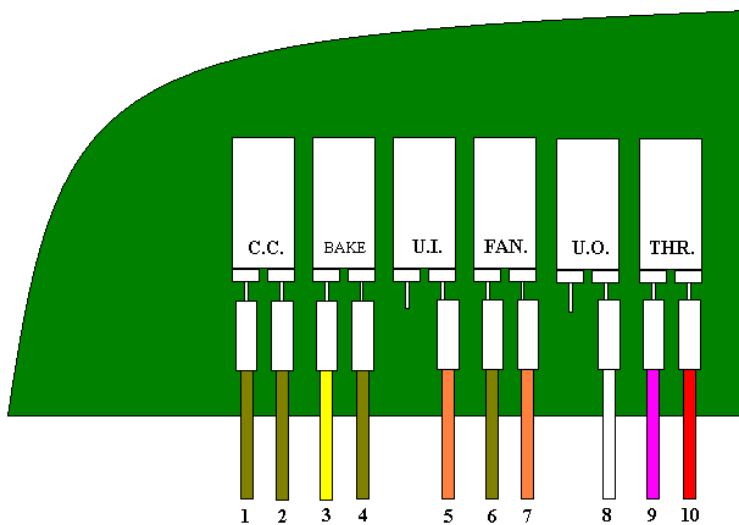

DESCRIPTION

- THR. Throat
- U.O. Upper Outer (Outer Grill)
- FAN. Convection Fan
- U.I. Upper Inner (Inner Grill)
- BAKE Concealed Bake Element
- C.C. Catalytic Converter (Smoke Eliminator)

WIRE COLOUR

- 1. Light Brown
- 2. Light Brown
- 3. Yellow
- 4. Light Brown
- 5. Orange
- 6. Light Brown
- 7. Orange
- 8. White
- 9. Pink
- 10. Red

Figure 7.9f

7.10 Power Transformer

Location: Under the service panel

Removal

1. Follow the general servicing instructions for components around the service panel area. (refer to Section 7.4)
2. Remove the top panel.
3. Remove the two wires from the power supply terminal block and the two wires from the power module. (refer to Technical Overview Section 2.25)

Note: Ensure that when removing the wires from the terminal block that they are refitted to the correct terminals.

4. Remove the four transformer retaining screws and lift out the transformer.

Note: Ensure the replacement transformer has the correct voltage and frequency.

Re-assembly

- Refit in reverse manner.
- Follow the reassembly procedure. (refer to Section 7.5)

7.11 Thermal Limiter



Location: In the back panel, top panel and service panel areas.

Removal

Note: Refer to the Technical Overview for thermal limiter locations and specifications.

1. Follow the servicing instructions for components around the back panel and service panel areas. (refer to Sections 7.3 & 7.4)
2. Remove the required panels.
3. Remove the wires from the faulty thermal limiter.
4. Remove the retaining screws and remove the limiter.

Reassembly

1. Refit in reverse manner.
2. Follow the reassembly procedure. (refer to Section 7.5)

7.12 Oven Temperature Sensor

Location: Oven cavity rear top left corner.

Removal

1. Remove the oven fan shroud. (refer to Section 7.19)
2. Remove the two screws securing the sensor to the oven cavity.
3. Pull the sensor wires through hole in the oven cavity wall until the wire connector is accessible and disconnect the faulty sensor.

Reassembly

1. Push the excess wire back through the hole in the oven cavity.
2. Refit in reverse manner.
- Follow the reassembly procedure. (refer to Section 7.5)

7.13 Oven Lamp Glass and Bulb

Location: Oven cavity back corners and top of the oven cavity opening.

Removal

1. Remove the glass cover by swivelling the retaining tab upward to clear the edge of glass.

Note: The retaining tabs are designed to be swivelled using a flat head screwdriver.

2. Remove the faulty bulb.

Caution: Do not handle halogen bulbs with bare hands. Use gloves or a cloth rag.

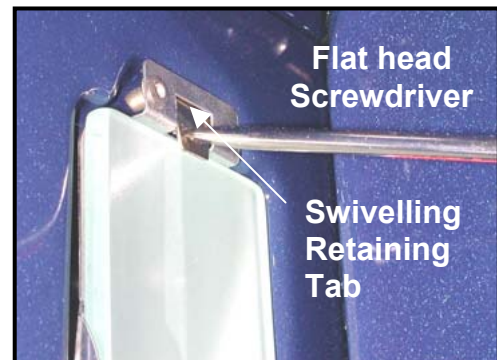

Figure 7.13

Reassembly

- Refit in reverse manner.

Note: Ensure the glossy side of the glass cover is facing the inside of the oven cavity.

7.14 Oven Lamp Assembly



Location: Rear corners and top, front of the oven cavity

For Rear Lamp Assemblies

Removal

1. Follow the general servicing instructions for components in the back panel area. (refer to Section 7.3)
2. Remove the lamp cover and bulb. (refer to Section 7.13)
3. Remove the lamp body retaining screws and the lamp holder retaining screws.
4. Disconnect the lamp assembly wires at the connectors in the back panel area.
5. Pull the lamp assembly wires out through the oven cavity.



Figure .14

Note: String can be tied on the end of the light assembly wires to aid in feeding the new wires back through the holes in the side insulation panel.

Reassembly

1. Feed the new wire connectors back through the hole in the side insulation panel.
2. Refit in reverse manner.
 - Follow the reassembly procedure. (refer to Section 7.5)

For Front Lamp Assembly

Removal

1. Follow the general servicing instructions for components in the control panel area. (refer to Section 7.2)
2. Remove the lamp cover and bulb. (refer to Section 7.13)
3. Disconnect the lamp assembly wires from the terminal block in the top panel area.
4. Remove the control panel. (refer to Section 7.2)
5. Remove the three screws along the front of the wiring panel and the two screws either side fixing the wiring panel.
6. Lift the front of the wiring panel to access the lamp assembly and wires.
7. Remove the lamp holder retaining screws.
8. Feed the wires through the hole in the wiring panel.

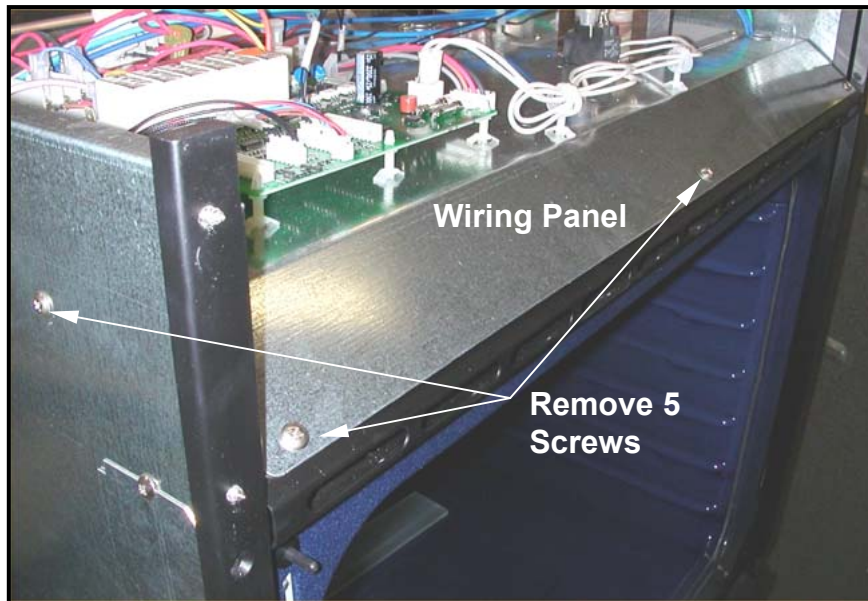

Figure 7.14b

Reassembly

1. Refit in reverse manner.
2. Follow the reassembly procedure. (refer to Section 7.5)

7.15 Oven Elements



Broil / Grill Element

Location: Top of the oven cavity

Removal

1. Remove the fan shroud. (refer to Section 7.19)
2. Remove the screws securing the Broil / Grill element to the top of the oven cavity and the support frame to the cavity roof.
3. Pull the Broil / Grill element through the hole in the oven cavity until the element terminals are accessible.

Note: Tilt the element forward so that the element terminals will clear the hole in the oven cavity.

4. Disconnect the wires and connect to the replacement element.

Reassembly

- Refit in reverse manner.
- Check the element operation. (refer to Diagnostics Section 4.3)

Fan Element



Location: Rear of the oven cavity

Removal

1. Remove the fan shroud. (refer to Section 7.19)
2. Remove the screws securing the fan element to the rear of oven.
3. Pull the element through the hole in the oven cavity until the wires are accessible.
4. Disconnect the wires and connect to the replacement element.

Reassembly

- Refit in reverse manner.
- Check the element operation. (refer to Diagnostics Section 4.3)



Bake element

Location: Under the oven cavity

Removal

1. Follow the general servicing instructions for components in the back panel area. (refer to Section 7.3)
2. Remove the two largest vent ducting sections.

For Single Ovens and Double Oven Lower Cavity

1. Remove the two screws on the bake element cover.
2. Bend the element cover down to clear the element.
3. Remove the element wires.
4. Remove the element retaining screw.
5. Pull the element out from under oven cavity.

Reassembly

- Refit in reverse manner.
- Follow the reassembly procedure. (refer to Section 7.5)

For Double Oven Upper Cavity

1. Remove the remaining section of vent ducting.
2. Disconnect the lower vent fan wires.
3. Remove the lower vent fan.
4. Remove the element wires.
5. Remove the two screws retaining the fan cover.

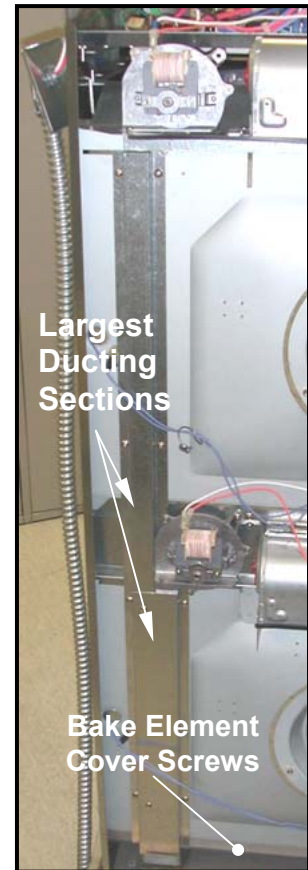

Figure 7.15a

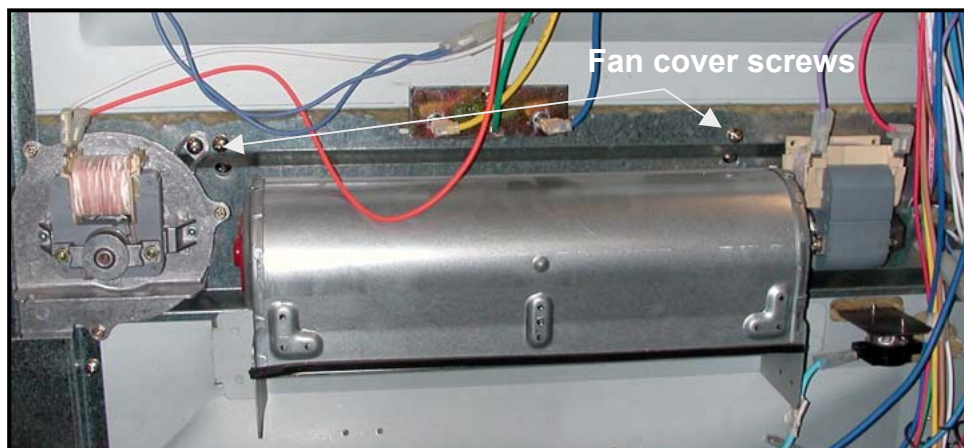

Figure 7.15b

6. Pull the fan cover with the cooling fan attached upward to clear the locating tabs.
7. Allow the fan cover to drop down to clear the element.
8. Remove the element retaining screw.
9. Pull the element out from under the oven cavity.

Reassembly

- Refit in reverse manner.

Note: When reinserting the element use a wide flat blade or similar object to lift the cavity insulation clear of the replacement element.

- Follow the reassembly procedure. (refer to Section 7.5)



7.16 Cooling Fan

Location: Back and top panel areas

Removal

- Follow the general servicing instructions for components in the back panel area. (refer to Section 7.3)

For single ovens and upper cooling fan on double ovens.

- Remove the top panel
- Remove the wires from the cooling fan motor.
- Remove the two screws on the left of the cooling fan and slide it out from the locating slot.
- Remove the four small retaining screws for the cooling fan side brackets and transfer the brackets to the replacement cooling fan.

Note: Check the replacement cooling fan is specified as in section 2.8.

For lower cooling fan on double ovens.

- Remove the back panel. (refer to Section 7.3)
- Remove the wires from the cooling fan motor.
- Remove the two screws on the right of the cooling fan and slide it out from the locating slot.
- Remove the four small retaining screws for the cooling fan side brackets and transfer the brackets to the replacement cooling fan.

Note: Check the replacement cooling fan is specified as in section 2.8.

Reassembly

- Refit in reverse manner.
- Follow the reassembly procedure. (refer to Section 7.5)

7.17 Vent Fan



Location: In the back panel area

Removal

For single ovens and upper cavity in double ovens

- Follow the general servicing instructions for components in the back panel area. (refer to Section 7.3)
- Remove the vent fan retaining screws.
- Remove the longest section of vent ducting.
- Remove the vent fan wires.
- Lift the vent fan out of the vent ducting and rotate counter-clockwise to clear surrounding parts.
- Separate the vent fan from the vent tube.

For lower cavity in double ovens

- Follow the general servicing instructions for components in the back panel area. (refer to Section 7.3)
- Remove the vent fan retaining screw.
- Remove the lower section of vent ducting.

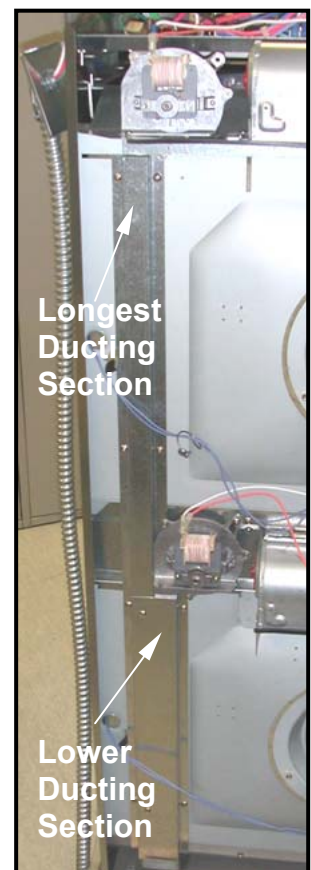

Figure 7.17

4. Remove the vent fan wires and transfer them to the replacement fan.
5. Separate the vent fan from the vent tube.

Reassembly

- Refit in reverse manner.
- Follow the reassembly procedure. (refer to Section 7.5)

7.18 Oven Cavity Fan



Location: Back panel area

Removal

1. Follow the general servicing instructions for components around the back panel area. (refer to Section 7.3)

Note: If the oven fan is not operating, check to see if the fan element is operating correctly. The element will burn out if it has no cooling air supply.

2. Disconnect the wires to the fan motor.
3. Remove the oven fan shroud. (refer to Section 7.20)
4. Remove the oven fan blade.

Note: Turn the fan blade securing nut clockwise to remove (left hand thread).

5. Remove the three fan motor mounting screws and remove the fan motor from the rear.
6. Transfer the mounting plate to the replacement fan motor.

Note: To remove the mounting plate use pliers to bend the holding tabs.

Reassembly

- Refit in reverse manner.
- Follow the reassembly procedure. (refer to Section 7.5)



Figure 7.18

7.19 Fan Shroud

Location: Rear wall of oven cavity

Removal

1. Remove the utensils, shelves and runners. (refer to section 7.20)
2. Remove the two screws securing the top of the shroud.

Note: Hold the shroud when removing screws as it will fall forward.
3. Remove the shroud from the two tongue slots at the bottom of the oven cavity.

Reassembly

- Refit in reverse manner.
- Follow the reassembly procedure. (refer to Section 7.5)

7.20 Runners

Location: Side walls of oven cavity

Removal

1. Lift the clip at the front of the runners.
2. Lift the front of the runners away from the side wall.
3. Pull the runners out of the oven to release them from the stud hangers at the rear.

Reassembly

- Refit in reverse manner.

7.21 Oven Door

Removal

1. Open the oven door to its fully open position (90° to oven).
2. Pull the hinge clips on the lower arm of the hinges forward until they lock onto the upper arm.
3. Raise the door ensuring the clips load the top arm of the hinges.
4. Lift the oven door out of the hinge slots.

Reassembly

1. Place the hinge arms into the hinge slots ensuring they lock into place.
2. Ensure the oven door is opened fully, unlock the upper arm from the hinge clips.
3. Raise the door slightly and ensure the hinge clips are released from the upper arms.
4. Check the door closes and seals correctly.

7.22 Oven Door – Disassembly



To separate door inner and door outer assemblies

1. Remove the door from the oven. (refer to Section 7.21)
2. Lay the door face down on a flat, clean working surface.
3. Remove the four hinge screws on the bottom of the door and the eight retaining screws down the sides of the door.
4. Separate the inner and outer door assemblies.

Door Inner Assembly

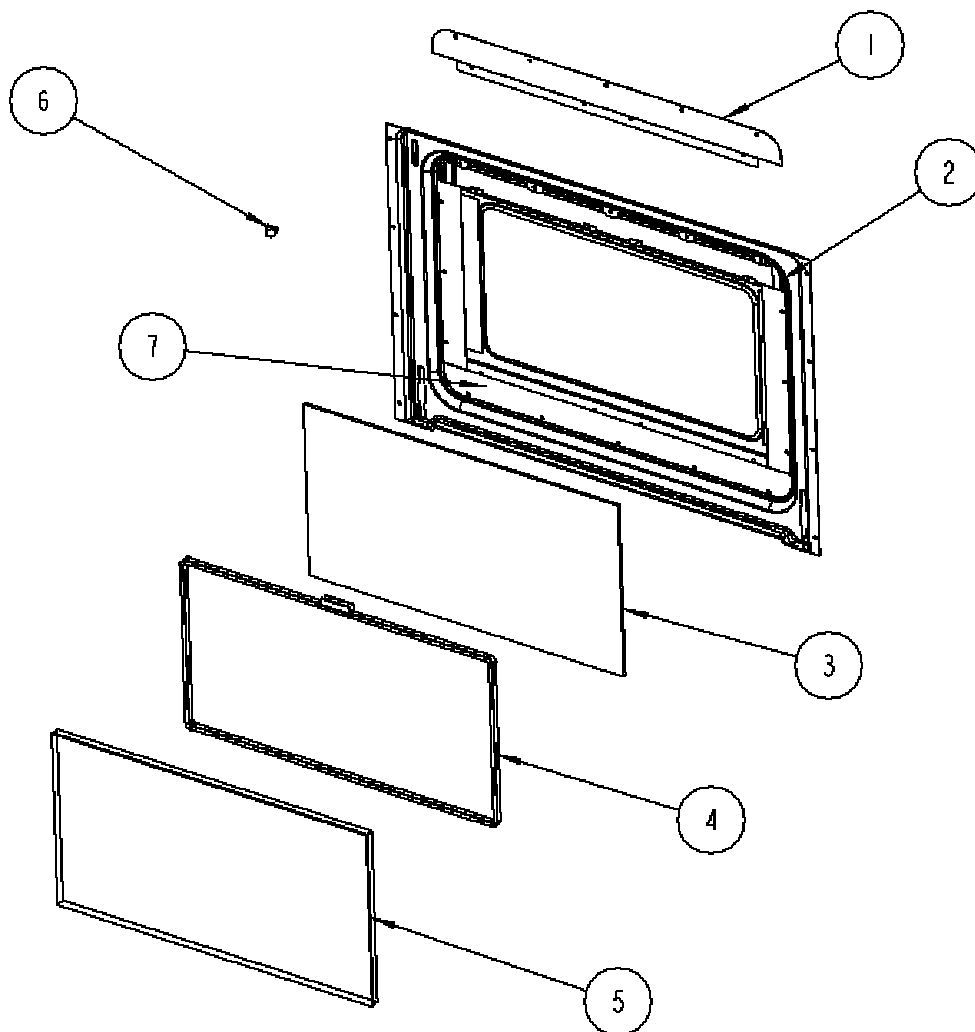

Figure 7.22a

Glass Pane removal

1. Remove the four screws securing the top retaining bracket. (no. 1)
2. Loosen the five screws on the insulation retainer panel. (no. 7)
3. Slide out the heat reflective glass pane. (no. 5)
4. Remove the inner glass pane and gasket. (no.'s 3&4)

Note: If transferring the gasket to a replacement glass pane then ensure the gasket join is located at the top of the door.

Note: **The glass pane has a reflective coating on one side only.** Ensure that the coating is facing the oven cavity when reassembled.

- To test if a glass pane has a heat reflecting coating, use an ohmmeter to test for continuity on the glass surface. If there is continuity then the glass will be coated.

Reassembly

- Refit in reverse manner.
- Ensure all glass surfaces are clean.

Door Outer Assembly

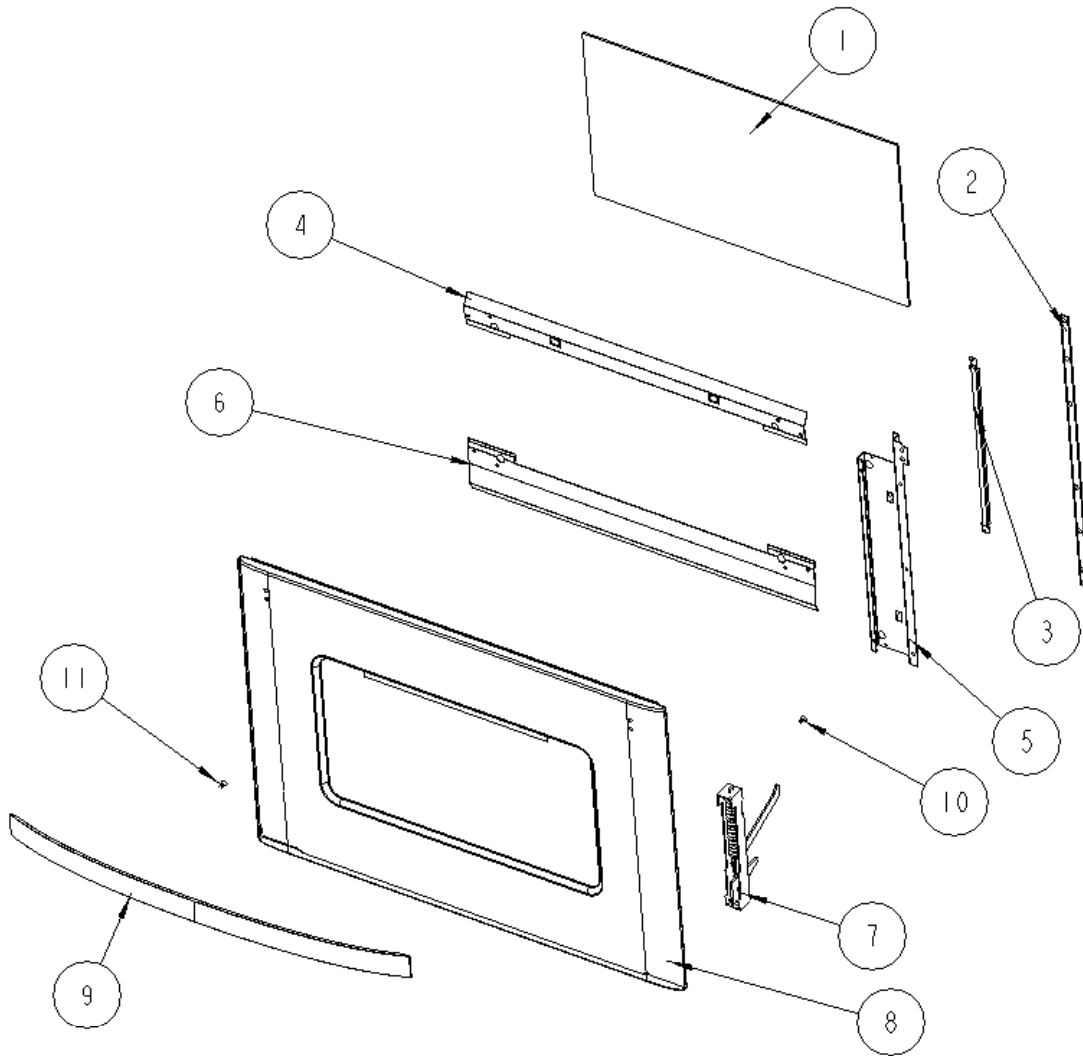

Figure 7.22b

Handle removal

1. Remove the four handle retaining screws in the top corners of the outer door assembly. (no.'s 9&11)

Reassembly

- Refit in reverse manner.

Glass Pane removal

1. Remove the four screws securing the heat shield panel. (no. 4)
2. Loosen the four screws securing the bottom flow guide panel. (no. 6)
3. Slide the heat reflective glass pane out from the bottom flow guide panel. (no. 1)

Reassembly

- Refit in reverse manner.

Door Hinge removal

1. Remove the heat reflective glass pane. (no. 1, refer previous)
2. Loosen the two inner screws on the outer door glass bracket and remove the three screws down the side of the bracket. (no. 5)
3. Slide the outer door glass bracket clear of the hinge stanchion.
4. Remove the door hinge retaining screw near the top of the stanchion. (no. 10)
5. Lift the door hinge and hinge stanchion enough to clear the edge of the door cap. (no. 8)

Caution: The inner edges of the stainless steel door cap are sharp.

6. Separate the door hinge from the hinge stanchion. (no. 7)

Reassembly

- Refit in reverse manner.

Note: If the upper hinge arm is not loaded, use an adjustable spanner to lower the upper arm so that the loading clip from the lower arm can be fitted.

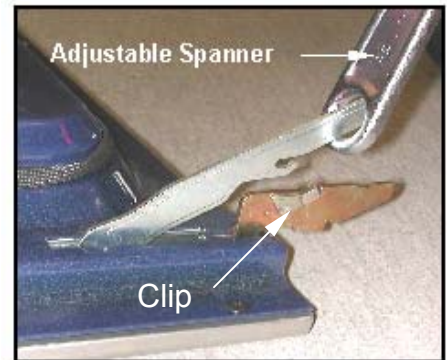

Figure 7.22

7.23 Meat Probe Socket



Location: Left hand side of the oven cavity

1. Remove the oven from the joinery cavity. (refer to Section 7.1)
2. Remove the switch service panel adjacent to the meat probe socket.
3. Remove the retaining nut securing the socket to the inside of the oven.
4. Remove the meat probe socket through the inspection hole.



Figure 7.23a

5. Remove the spade terminals from the meat probe socket.

Reassembly

- Refit in reverse manner.

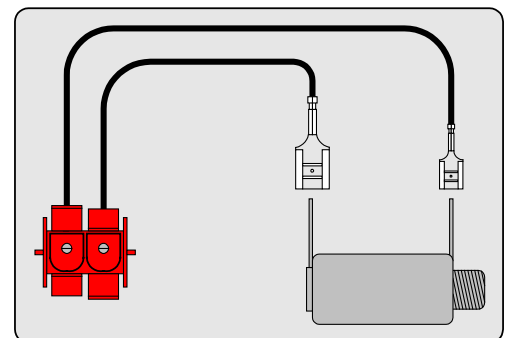

Figure 7.22b

7.24 Oven Door Lock Assembly

Location: Left hand side panel

- If the door lock is engaged and the door cannot be opened, refer to the following procedure.

1. Remove the oven from the joinery cavity. (refer to Section 7.1)
2. Remove the front door lock inspection panel.
3. Remove the link pin cir-clip and disconnect the link arm.

Note: Take care not to lose the link pin cir-clip or pin.

- The door lock will now be free to disengage.
- If the door lock needs to be replaced refer to following procedure.

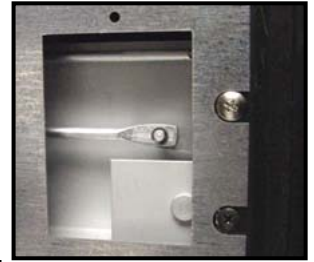

Figure 7.24

Removal

1. Follow the general servicing instructions for components around the back panel and service panel areas. (refer to Sections 7.3 & 7.4)
2. Remove the door switch and lock motor wiring harnesses from the power module and disconnect the two wires from the isolating relay.
3. Remove the front and rear door lock assembly retaining screws.
4. Remove the wire connector from the door switch. (This is only necessary for the upper door lock on a double oven.)
5. Slide the door lock assembly out the rear of the side panel.

Note: Take care not to lose the door switch spring when removing the door lock assembly.

Reassembly

- Refit in reverse manner.
- Follow the reassembly procedure. (refer to Section 7.5)

Note: Ensure the isolating relay wires are connected.

7.25 Component Location Guide

For US/NZ/AUS Products

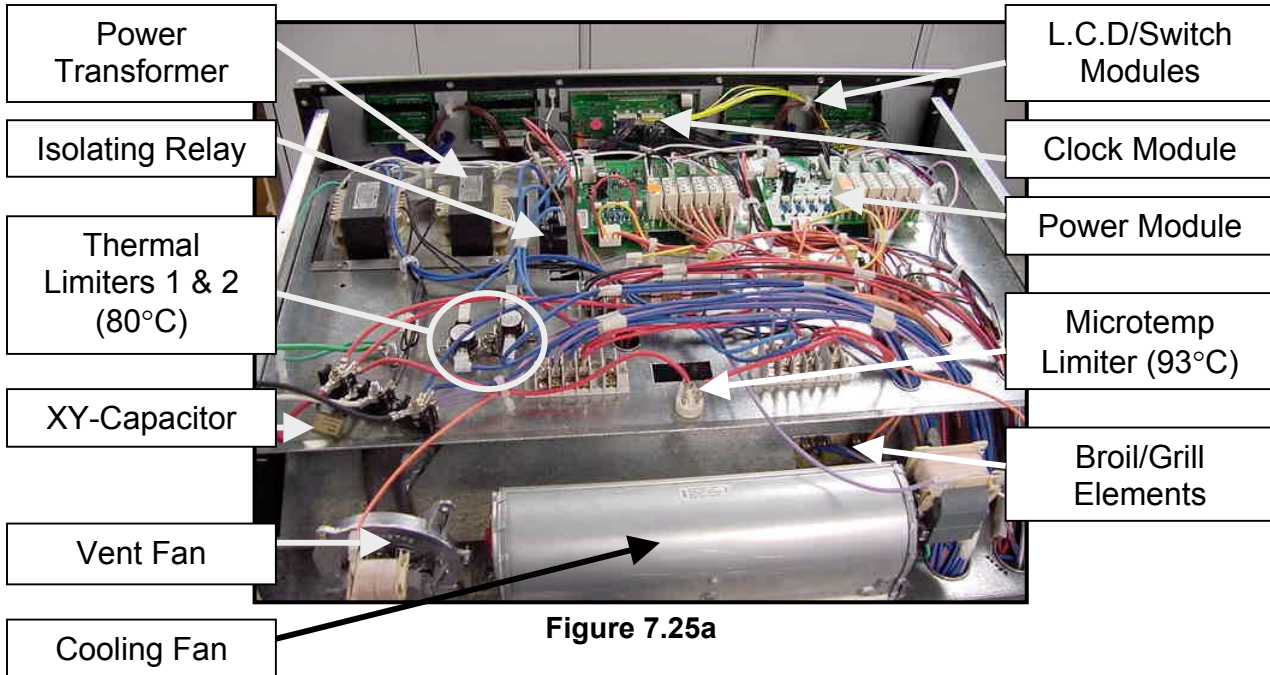

Figure 7.25a

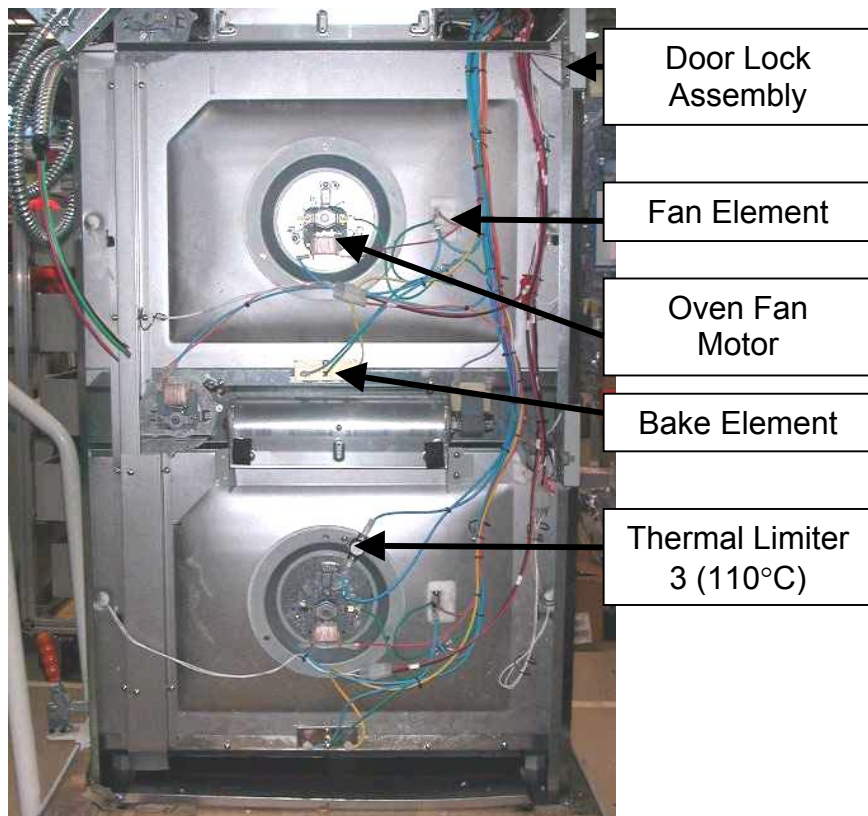

Figure 7.25b

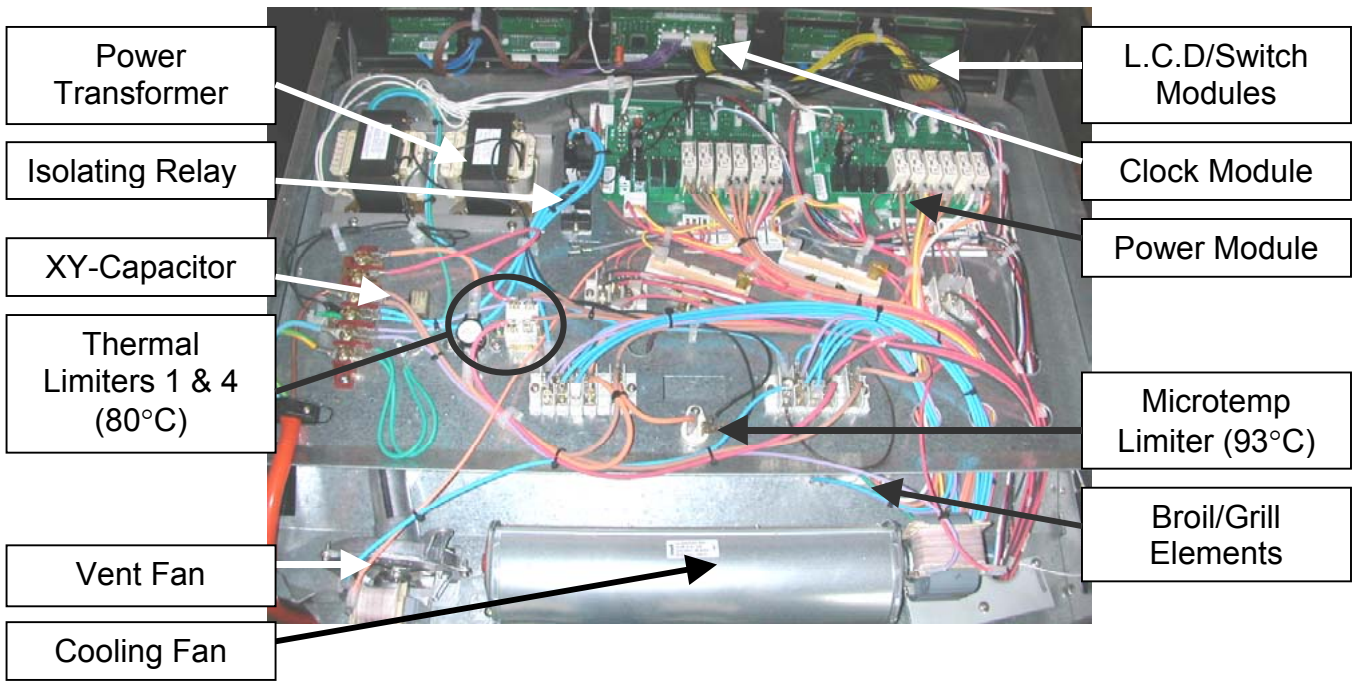

Figure 7.25c

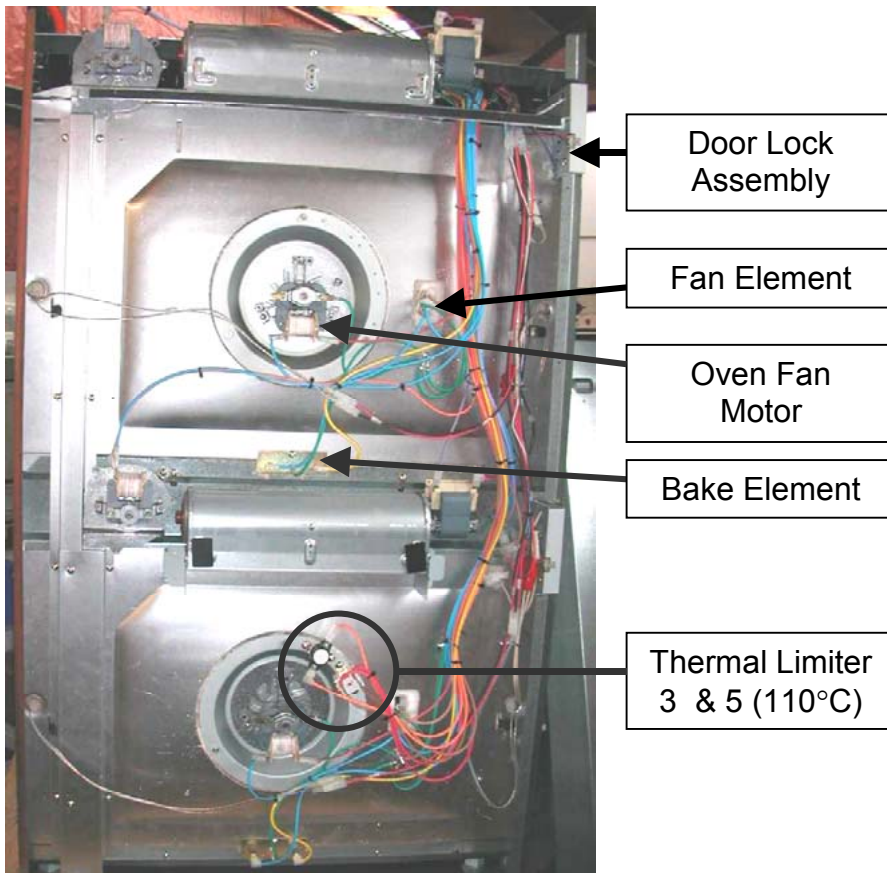

Figure 7.25d

NOTES