

**30, 36 & 48 INCH
DUAL FUEL
RANGES**



 **Electrolux**

5995461133 2/2006

SAFE SERVICING PRACTICES - ALL APPLIANCES

To avoid personal injury and/or property damage, it is important that **Safe Servicing Practices** be observed. The following are some limited examples of safe practices:

1. **DO NOT** attempt a product repair if you have any doubts as to your ability to complete it in a safe and satisfactory manner.
2. Before servicing or moving an appliance:
 - Remove the power cord from the electrical outlet, trip the circuit breaker to the OFF position, or remove the fuse.
 - Turn off the gas supply and allow any residual gas to dissipate for 10 to 20 minutes.
3. Never interfere with the proper operation of any safety device.
4. **USE ONLY REPLACEMENT PARTS CATALOGED FOR THIS APPLIANCE. SUBSTITUTIONS MAY DEFEAT COMPLIANCE WITH SAFETY STANDARDS SET FOR HOME APPLIANCES.**
5. **GROUNDING:** The standard color coding for safety ground wires is **GREEN**, or **GREEN** with **YELLOW STRIPES**. Ground leads are not to be used as current carrying conductors. It is **EXTREMELY** important that the service technician reestablish all safety grounds prior to completion of service. Failure to do so will create a hazard.
6. Prior to returning the product to service, ensure that:
 - All electrical connections are correct and secure
 - All electrical leads are properly dressed and secured away from sharp edges, high-temperature components, and moving parts
 - All non-insulated electrical terminals, connectors, heaters, etc. are adequately spaced away from all metal parts and panels
 - All safety grounds (both internal and external) are correctly and securely connected
 - All panels are properly and securely reassembled

ATTENTION!!!

This service manual is intended for use by persons having electrical and mechanical training and a level of knowledge of these subjects generally considered acceptable in the appliance repair trade. Electrolux Major Appliances cannot be responsible, nor assume any liability, for injury or damage of any kind arising from the use of this manual.

Safe servicing practices	2
Service failure mode	8
Resistance chart	9
Testing the function and temperature selectors	10
Function selector	10
Temperature selector	10
Specifications	11
30 inch duel fuel freestanding range	11
Smooth glide on racks	11
Four burner, interlocking grates	11
Third element, European convictions system	11
Vantage flame	11
Sealed cooktop spill-basin	11
Control panel features	12
Cooktop	12
Oven cavity	12
Additional features	12
Accessories	12
Black knobs	12
Backsplash	12
Cut out dimensions	12
36 inch duel fuel freestanding range	14
Smooth glide on racks	14
Six burner, interlocking grates	14
Third element, European convictions system	14
Vantage flame	14
Sealed cooktop spill-basin	14
24" optional backsplash	14
Control panel features	15
Cooktop	15
Oven cavity	15
Additional features	15
Accessories	15
Black knobs	15
Backsplash	15
Cut out dimensions	15
48 inch duel fuel freestanding range	17
Smooth glide on racks	17
Six burner, interlocking grates	17
Third element, European convictions system	17
Vantage flame	17
Sealed cooktop spill-basin	17
24" optional backsplash	17
Control panel features	18
Cooktop	18
Large oven cavity	18
Small oven cavity	18
Additional features	18
Accessories	18
Black knobs	18
Backsplash	18
Cut out dimensions	18
Sample wiring diagram of the large oven section	20
Sample wiring diagram of the small oven section	21
Sample wiring diagram of the top burner section	22

Section A - OWNER'S GUIDE	23
Safety	23
Safety precautions	23
Definitions	23
General precautions	23
Liquefied petroleum (propane) gas conversion	25
Features overview	26
Model features	26
Cooktop features	27
Proper burner adjustments	27
Burner locations	27
Sealed burner configurations	28
Brass burner rings	28
Burn igniters	28
Control knobs	28
Placement of burner grates	28
Flame adjustment	29
Surface cooking	29
Using the griddle	30
Using the wok stand	30
To properly position the wok stand	31
Using the simmer plate	31
Setting surface controls	31
Operation	33
Before cooking	33
Operating the control valves	33
Setting the burner flame height	33
Energy saving tips	34
Getting started	35
Installing and removing the oven rack supports	35
Removing and replacing the oven racks	35
Arranging oven racks	36
Recommended rack position for broiling, baking and roasting	36
Baking layer cakes with 1 or 2 oven racks	36
Air circulation in the oven	37
Companion oven	37
Setting oven control	37
Selector knob function	37
Oven functions	37
Cooking instructions	38
Baking	38
Baking problems	39
Convection baking	40
Convection roasting	40
Broiling	41
Broiling times	42
Using the self-clean feature	43
Starting the oven self-clean cycle	43
Cleaning tips for range cooktop	44
Cleaning stainless steel surfaces	45
Cleaning knobs and knob bezels	45
Cleaning burner bases	45
Cleaning burner rings	46
Cleaning burner igniters	46
General cleaning	47
Oven light	48

To replace the oven light _____	48
Solutions to common problems _____	49
Service failure mode definitions _____	51
Sample warranty _____	52
Section B - INSTALLATION INSTRUCTIONS _____	53
Safety _____	53
Definitions _____	53
Finding information _____	54
Preparing for installation _____	54
Gas supply requirements _____	54
Gas and electric requirements table _____	54
Electrical power supply requirements _____	55
Gas and electrical rough-in _____	55
Cabinet and countertop preparation _____	55
Cutout dimensions _____	57
E36DF76EPS and E48DF76EPS overall dimensions side view _____	58
E30DF74EPS overall dimensions side view _____	59
Installing the anti-tip bracket _____	60
Gas regulator and electrical conduit location _____	63
Installing optional backguards _____	64
Removing the oven door _____	65
Reinstalling the oven door _____	65
Making the electrical connections _____	66
Grounding instructions _____	66
Connecting to a four-wire electrical system _____	66
Connecting the green appliance wire to the neutral supply wire _____	66
Connecting the green appliance wire to a grounded supply wire or a grounded cold water pipe _____	67
Making the gas connection _____	68
Installing the range _____	68
Installing the burner components _____	68
Operation _____	69
SECTION C - THEORY OF OPERATION _____	70
Gas flow _____	70
Top burner ignition and reignition system _____	73
Oven operation _____	74
Air movement in the oven during convection bake and convection roast _____	76
Cooling blower air movement _____	77
The self-cleaning cycle _____	78
SECTION D -TROUBLEINGSHOOTING _____	79
Index _____	79
Electrical components will not operate _____	80
Flame too large and yellow on top burner _____	80
Flame too small on top burner _____	80
Flame goes out, when valve is turned to the low position _____	80
Top burners, not burning properly _____	80
One top burner, not burning properly _____	81
Top burner valve difficult to turn _____	81
Igniters do not spark when the burner knob is turned to the lite position _____	81
Igniters spark but burner does not ignite _____	81
Igniters continue to spark after burner is ignited _____	81
Oven does not operate in any fuction _____	82
Oven temperature off more than 10° _____	83
Oven does not operate in bake _____	83
Oven does not operate in broil _____	84
Oven does not heat in convection bake and convection fan does not run _____	84

Oven heats in convection bake but convection fan does not operate _____	84
Oven does not heat in convection bake but the convection fan runs _____	85
Oven does not heat in convection roast and convection fan does not run _____	85
Oven does not heat in convection roast but convection fan runs _____	86
Oven heats in convection roast but convection fan does not operate _____	86
LEDs do not light _____	86
One LED does not light _____	86
Cooling fan does not operate _____	86
Oven does not operate in self-cleaning _____	87
One oven light does not light _____	87
Both oven lights do not light _____	87
SECTION E - TEARDOWN _____	88
Removing the grates _____	88
Removing the burner caps _____	88
Removing the burner rings _____	88
Removing the burner heads _____	88
Removing the igniters _____	89
Removing the knobs _____	89
Removing the knob bezels _____	90
Removing the backsplash _____	90
Removing the spill tray _____	90
Removing the burner tube _____	91
Removing the air shutter tube _____	91
Removing the orifice _____	91
Removing the front spill tray support trim _____	91
Removing the front spill tray support _____	92
Removing the side spill tray support _____	92
Removing the burner tube assembly _____	92
Removing the igniter module _____	93
Removing the electronic oven control board _____	94
Removing the oven light transformer _____	94
Removing the oven high temp limit _____	95
Removing the oven door handle _____	95
Removing the oven door _____	96
Removing the oven door seal _____	96
Removing the oven door inner liner _____	96
Removing the oven door cams and springs _____	97
Removing the oven door air directional baffle _____	97
Removing the oven door air baffle _____	97
Removing the oven door glass package shield _____	98
Removing the oven door glass package _____	98
Removing the oven door glass package seal _____	98
Removing the air intake grill _____	98
Removing the control panel _____	99
Removing the temperature selector _____	99
Removing the interface board _____	100
Removing the function selector _____	100
Removing the top burner igniter switch _____	100
Removing the top burner valve _____	100
Removing the manifold pipe _____	101
Removing the kick panel assembly _____	101
Removing the bake element _____	102
Removing the convection filter screen _____	102
Removing the broil element _____	102
Removing the convection baffle _____	103
Removing the convection fan blade _____	103
Removing the convection element _____	103

Removing the smoke eliminator _____	103
Removing the oven sensor _____	104
Removing the rack support _____	104
Removing the oven light _____	104
Removing the oven latch assembly _____	105
Removing the pressure regulator _____	105
Removing the back cover _____	105
Removing the convection fan motor _____	106
Removing the air channel cover _____	106
Removing the air channel _____	107
Removing the cooling fan assembly _____	107
Removing the cooling fan assembly cover _____	107
Removing the remove oven rack switch _____	107
Removing the pressure regulator _____	108
Removing the side panel _____	108
Removing the side filler (36" models) _____	109
Removing the door rollers _____	110

Service Failure Mode

Failure Mode Definition							
Front Panel LED							Failure Description
1	2	3	4	5	6	7	
X				X			Runaway Temperature
X					X		Incorrect Micro ID
X						X	Incorrect EEPROM Checksum
		X		X			Open Temperature Probe
		X			X		Shorted Temperature Probe
	X		X				Max Unlock Time Exceeded (Motor Door Latch)
	X			X			Max Unlock Attempts.Exceeded (Motor Door Latch)
	X				X		Max Lock Time Exceeded (Motor Door Latch)
	X	X				X	Max Lock Attempts.Exceeded (Motor Door Latch)
	X	X	X				Motor Door Latch Failed During Clean Operation
			X				Inter Processor Communications Failure (Motor Door Latch)
LED Definitions							
1 - Bake				5 - Clean			
2 - Convection Bake				6 - Lock			
3 - Convection Roast				7 - Remove Racks			
4 - Broil							

Runaway Temperature. Check the resistance of the oven temperature probe should be between 1050 & 1100 ohms. If good, replace electronic control board.

Incorrect micro ID. Replaced electronic control board.

Incorrect EEPROM Checksum. Replaced electronic control board.

Open temperature probe. Check the resistance of the oven temperature probe should be between 1050 & 1100 ohms. If good, replace electronic control board.

Shorted temperature probe Check the resistance of the oven temperature probe should be between 1050 1100 ohms. If good, replace electronic control board.

Max unlock Time exceeded (motor door latch) Set the oven up for a clean cycle. Does the latch motor turned? No Checked the voltage applied to the latch motor. If line a neutral replace latch mechanism. If zero replace electronic control board. Check the phase switch and the locks switch. They should be open with the door locked and closed with a door locked. If the switch is checked good replace electronic control board.

Max unlock Attempts exceeded (motor door latch) Set the oven up for a clean cycle. Does the latch motor turned? No Checked the voltage applied to the latch motor. If lined a neutral relace latch mechanism. If zero replace electronic control board. Check the phase switch and the locks switch. They should be open with the door locked and closed with a door locked. If the switch is checked good replace electronic control board.

Max lock Time exceeded (motor door latch)

Set the oven up for a clean cycle. Does the latch motor turn?
No. Check the voltage applied to the latch motor. If lined to neutral replace latch mechanism. If zero, replace electronic control board.
Yes. Check the phase and lock switches. They should be closed with the door locked and open with a door unlocked. If the switch is checked good replace the electronic control board.

Max lock Attempts exceeded (motor door latch)

Set the oven up for a clean cycle. Does the latch motor turn?
No. Check the voltage applied to the latch motor. If line to neutral replace latch mechanism. If zero replace electronic control board.
Check the phase switch and the lock switches. They should be closed with the door locked and open with a door unlocked. If the switch is checked good replace the electronic control board.

Inter processor communications failure (motor door latch)

Replace electronic control Board.

Resistance chart

Oven sensor	1050 to 1100 ohms
Bake element (large oven)	17 ohms +/-10%
Bake element (small oven)	27 ohms +/-10%
Broil element (large oven)	14 ohms +/-10%
Broil element (small oven)	19 ohms +/-10%
Convection element (large oven)	26 ohms +/-10%
Convection element (small oven)	26 ohms +/-10%
Convection fan motor	58 ohms +/-10%
Cooling fan motor	10 ohms +/-10%
Oven light transformer primary	62 ohms +/-10%
Oven light transformer secondary	1 ohms
Locked motor	2500 ohms +/-10%

Testing Function and temperature selectors

The function and temperature selectors both use a Piher N-15 10 Kohm pot. Note that the tolerance on this part is 30%, so the measured resistance between pins 1 & 3 will be $10,000 \pm 3,000$ Ohms. The controller uses a ratiometric approach to determine position so this variation does not affect the software.

Function selector

The function selector usually fails, open or intermittent. When this happens, the oven will not operate in any function.

To test the functions selector in the field:

1. Measure the resistance between pins one and three.

If the reading is between 7000 and 13,000 ohms go to step 2.

If the reading is not between 7000 and 13,000 ohms, the function selector is defective.

2. Set the function Selector to bake and measure the resistance between pins two and three.

If the reading is between 580 and 1720 ohms, the function selector is good.

If the reading is not between 580 and 1720 ohms, the function selector is defective.

Temperature selector

The temperature selector usually fails, open or intermittent. When this happens, the oven will not operate in any function.

To test the temperature selector in the field:

1. Measure the resistance between pins one and three.

If the reading is between 7000 and 13,000 ohms go to step 2.

If the reading is not between 7000 and 13,000 ohms, the temperature selector is defective.

2. Set the temperature selector to 300° and measure the resistance between pins two and three.

If the reading is between 2200 and 4300 ohms, the temperature selector is good.

If the reading is not between 2200 and 4300 ohms, the temperature selector is defective.

Note: It is sometimes easier to make these measurements by disconnecting plug P9 from the electronic oven control board and measuring in the harness side of the plug. When testing the function selector at plug P9 pins four and six should read between 7000 and 13,000 ohms and pins five and six should read 580 to 1720 ohms. When testing the temperature selector at plug P9 pins one and three should read between 7000 and 13,000 ohms and pins two and three should read between 2200 and 4300 ohms.

SPECIFICATIONS

30" Dual-Fuel Freestanding Range

- Product Weight – 260 Lbs.
- Electrical Requirements – 240 Volts AC, 4-wire, 60 Hertz, 30 Amps Dedicated Circuit.
- Total Connected Load – 4.1 kW. (17 Amps)
- Always consult local and /or national electric and gas codes.
- Range ships with 3/4" factory regulator.
- LP conversion kit supplied.
- Overhead cabinetry should not exceed a 13" maximum depth.
- Allow 30" minimum clearance between top of rangetop and bottom of unprotected wood or metal overhead cabinetry.
- Allow 10" minimum clearance from edge of rangetop to nearest combustible wall on either side of unit.
- Allow 24" minimum clearance when bottom of wood or metal overhead cabinet is protected by not less than 1/8" flame-retardant millboard covered with not less than No. 28 MGS sheet steel, 0.015" stainless steel, 0.024" aluminum or 0.020" copper.
- To reduce risk of fire when using overhead cabinetry, install range hood that projects horizontally a recommended minimum of 5" beyond bottom of cabinets.

Note: *Refer to Product Installation Guide for detailed instructions on the web at www.electroluxusa.com.*

Smooth-Glide™ Oven Racks

Imagine oven racks that glide with unparalleled ease and extend fully for effortless access to your meal. We designed a centered easy-grip handle and a patented ball-bearing rack system for smooth-gliding performance with the touch of a finger.

Four Burners, Interlocking Grates

Designed for cooking multiple dishes at varying temperatures on a single rangetop. Interlocking grates spread weight over a broad area providing an ultrastable cook surface.

Third Element European Convection System

By adding a third cooking element and a convection fan, heat is distributed faster and more evenly throughout the oven. Cooking every meal to perfection has never been easier.

Vantage Flame™

The automatic re-ignition feature allows the ignitors to spark spontaneously should the flame go out or become severely distorted by a draft, providing ease-of-mind while cooking.

Sealed Cooktop Spill-Basin

Cleanup is convenient with individual black porcelain-coated areas beneath each burner to catch spills.

30" DUAL-FUEL FREESTANDING RANGE

CONTROL PANEL FEATURES

Electronic Oven Control _____ Yes
Formed Stainless Steel Platform _____ Yes
Large Professional Skirted Knobs with Bezel _____ 6

COOKTOP

Sealed Power Burner™ – 17,000 BTU _____ 1
Sealed Burner™ – 15,000 BTU _____ 2
Sealed Precision Burner™ – 8,500 - 850 BTU _____ 1
Interlocking Grates _____ 3
Electronic Ignition with Auto Re-Ignition _____ Yes

OVEN CAVITY

Capacity _____ 3.9 Cu. Ft.
Bake Element _____ 3400 Watt
Broil Element _____ 4000 Watt
Convection Element _____ 2200 Watt
Cobalt Blue Interior _____ Yes
3rd Element European Convection System _____ Yes
Self-Clean with Door Lock _____ Yes
Oven Light _____ 2
Eight-Pass Bake & Broil _____ Yes
Smooth-Glide™ Racks _____ 3
Conventional Rack _____ 1

ADDITIONAL FEATURES

6" Stainless Steel Backsplash _____ Yes
Full Stainless Steel Side Panels _____ Yes
Professional Handle _____ Yes
Fully Adjustable, Heavy-Duty Legs _____ Yes

ACCESSORIES

Broil Pan and Insert _____ Included
Stainless Steel Cleaner _____ Included
Griddle _____ Included
Wok Ring _____ Included
Simmer Plate _____ Included

Black Knobs

Black Burner Knob _____ Optional
Black Thermostat Knob _____ Optional
Black Oven Selection Knob _____ Optional

Backsplash –

9" Stainless Steel – ACCBG09-30 _____ Optional

12" Stainless Steel – ACCBG12-30 _____ Optional
Stainless Steel Kick Plate – KIKPLT30 _____ Optional

SPECIFICATIONS

Cutout Dimensions –

Height _____ 31-3/4"
Width _____ 30-1/16"
Depth _____ 24
LP Conversion Kit _____ Included
Voltage Rating _____ 240V / 30 Amp
Product Weight _____ 260 Lbs.
Shipping Weight _____ 289 Lbs.
UPC (0-12505-) _____ 53956-

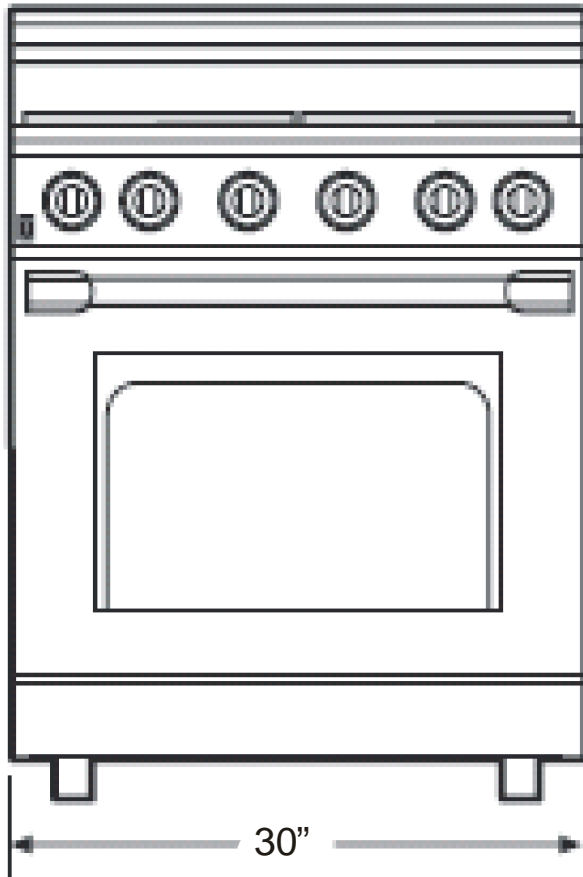

NOTE: Always consult local and / or national electric codes. Refer to Product Installation Guide for detailed installation instructions on the web at www.electroluxusa.com.

High standards of quality at Electrolux Home Products mean we are constantly working to improve our products. We reserve the right to change specifications or discontinue models without notice.

36" Dual-Fuel Freestanding Range

- Product Weight – 378 Lbs.
- Electrical Requirements – 240 Volts AC, 4-wire, 60 Hertz, 30 Amps Dedicated Circuit.
- Total Connected Load – 5.0 kW (24 Amps)
- Always consult local and /or national electric and gas codes.
- Range ships with 3/4" factory regulator.
- Lp conversion kit supplied.
- Overhead cabinetry should not exceed a 13" maximum depth.
- Allow 30" minimum clearance between top of rangetop and bottom of unprotected wood or metal overhead cabinetry.
- Allow 10" minimum clearance from edge of rangetop to nearest combustible wall on either side of unit.
- Allow 24" minimum clearance when bottom of wood or metal overhead cabinet is protected by not less than 1/8" flame-retardant millboard covered with not less than No. 28 MGS sheet steel, 0.015" stainless steel, 0.024" aluminum or 0.020" copper.
- To reduce risk of fire when using overhead cabinetry, install range hood that projects horizontally a recommended minimum of 5" beyond bottom of cabinets.

Note: Refer to Product Installation Guide for detailed instructions on the web at www.electroluxusa.com.

Smooth-Glide™ Oven Racks

Imagine oven racks that glide with unparalleled ease and extend fully for effortless access to your meal. We designed a centered easy-grip handle and a patented ball-bearing rack system for smooth-gliding performance with the touch of a finger.

Six Burners, Interlocking Grates

Designed for cooking multiple dishes at varying temperatures on a single rangetop. Interlocking grates

spread weight over a broad area providing an ultrastable cook surface.

Third Element European Convection System

By adding a third cooking element and a convection fan, heat is distributed faster and more evenly throughout the oven. Cooking every meal to perfection has never been easier.

Vantage Flame™

The automatic re-ignition feature allows the ignitors to spark spontaneously should the flame go out or become severely distorted by a draft, providing ease-of-mind while cooking.

Sealed Cooktop Spill-Basin

Cleanup is convenient with individual black porcelain-coated areas beneath each burner to catch spills.

24" Optional Backsplash

The optional 24" stainless steel backsplash protects your walls from accidental cooking spills or splashes while enhancing the professional appearance of your Electrolux ICON™ freestanding range. The heavy-duty 9" shelf provides easy access to and convenient storage of cooking ingredients, spices and pots and pans.

36" DUAL-FUEL FREESTANDING RANGE

CONTROL PANEL FEATURES

Electronic Oven Control _____ Yes
 Formed Stainless Steel Platform _____ Yes
 Large Professional Skirted Knobs with Bezel _____ 8

COOKTOP

Sealed Power Burner™ – 17,000 BTU _____ 2
 Sealed Burner™ – 15,000 BTU _____ 2
 Sealed Precision Burner™ – 8,500 - 850 BTU _____ 2
 Interlocking Grates _____ 3
 Electronic Ignition with Auto Re-Ignition _____ Yes

OVEN CAVITY

Capacity _____ 4.6 Cu. Ft.
 Bake Element _____ 3400 Watt
 Broil Element _____ 4000 Watt
 Convection Element _____ 2200 Watt
 Cobalt Blue Interior _____ Yes
 3rd Element European Convection System _____ Yes
 Self-Clean with Door Lock _____ Yes
 Oven Light _____ 2
 Eight-Pass Bake & Broil _____ Yes
 Smooth-Glide™ Racks _____ 3
 Conventional Rack _____ 1

ADDITIONAL FEATURES

3" Stainless Steel Backsplash _____ Yes
 Full Stainless Steel Side Panels _____ Yes
 Professional Handle _____ Yes
 Fully Adjustable, Heavy-Duty Legs _____ Yes

ACCESSORIES

Broil Pan and Insert _____ Included
 Stainless Steel Cleaner _____ Included
 Griddle _____ Included
 Wok Ring _____ Included
 Simmer Plate _____ Included

Black Knobs

Black Burner Knob _____ Optional
 Black Thermostat Knob _____ Optional
 Black Oven Selection Knob _____ Optional

Backsplash

9" Stainless Steel – ACCBG09-36 _____ Optional
 24" Stainless Steel with 9" Shelf – ACCBG24-36 _____ Optional
 Stainless Steel Kick Plate – KIKPLT36 _____ Optional

SPECIFICATIONS

Cutout Dimensions

Height _____ 32-5/8"
 Width _____ 36-1/16"
 Depth _____ 24"
 LP Conversion Kit _____ Included
 Voltage Rating _____ 240V / 30 Amp
 Product Weight _____ 378 Lbs.
 Shipping Weight _____ 420 Lbs.
 UPC (0-12505-) _____ 53957-2

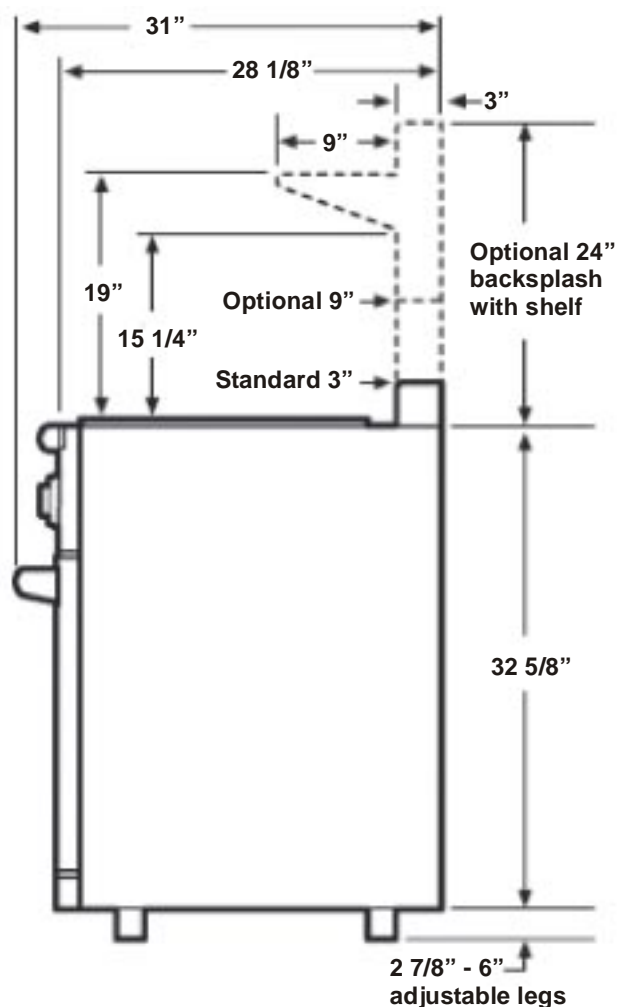



NOTE: Always consult local and / or national electric codes. Refer to Product Installation Guide for detailed installation instructions on the web at www.electroluxusa.com.

High standards of quality at Electrolux Home Products mean we are constantly working to improve our products. We reserve the right to change specifications or discontinue models without notice.

48" Dual-Fuel Freestanding Range

- Product Weight – 540 Lbs.
- Electrical Requirements – 240 Volts AC, 4-wire, 60 Hertz, 50 Amps Dedicated Circuit.
- Total Connected Load – 10.0 kW (42 Amps)
- Always consult local and /or national electric and gas codes.
- Range ships with 3/4" factory regulator.
- LP conversion kit supplied.
- Overhead cabinetry should not exceed a 13" maximum depth.
- Allow 30" minimum clearance between top of rangetop and bottom of unprotected wood or metal overhead cabinetry.
- Allow 10" minimum clearance from edge of rangetop to nearest combustible wall on either side of unit.
- Allow 24" minimum clearance when bottom of wood or metal overhead cabinet is protected by not less than 1/8" flame-retardant millboard covered with not less than No. 28 MGS sheet steel, 0.015" stainless steel, 0.024" aluminum or 0.020" copper.
- To reduce risk of fire when using overhead cabinetry, install range hood that projects horizontally a recommended minimum of 5" beyond bottom of cabinets.

Note: *Refer to Product Installation Guide for detailed instructions on the web at www.electroluxusa.com.*

Smooth-Glide™ Oven Racks

Imagine oven racks that glide with unparalleled ease and extend fully for effortless access to your meal. We designed a centered easy-grip handle and a patented ball-bearing rack system for smooth-gliding performance with the touch of a finger.

Six Burners, Interlocking Grates

Designed for cooking multiple dishes at varying temperatures on a single rangetop. Interlocking grates

spread weight over a broad area providing an ultrastable cook surface.

Third Element European Convection System

By adding a third cooking element and a convection fan, heat is distributed faster and more evenly throughout the oven. Cooking every meal to perfection has never been easier.

Vantage Flame™

The automatic re-ignition feature allows the ignitors to spark spontaneously should the flame go out or become severely distorted by a draft, providing ease-of-mind while cooking.

Sealed Cooktop Spill-Basin

Cleanup is convenient with individual black porcelain-coated areas beneath each burner to catch spills.

24" Optional Backsplash

The optional 24" stainless steel backsplash protects your walls from accidental cooking spills or splashes while enhancing the professional appearance of your Electrolux ICON™ freestanding range. The heavy-duty 9" shelf provides easy access to and convenient storage of cooking ingredients, spices and pots and pans.

48" DUAL-FUEL FREESTANDING RANGE

CONTROL PANEL FEATURES

Electronic Oven Control _____ Yes
 Formed Stainless Steel Platform _____ Yes
 Large Professional Skirted Knobs with Bezel _____ 10

COOKTOP

Sealed Power Burner™ – 17,000 BTU _____ 2
 Sealed Burner™ – 15,000 BTU _____ 2
 Sealed Precision Burner™ – 8,500 _____ 2
 Interlocking Grates _____ 3
 Electronic Ignition with Auto Re-Ignition _____ Yes

LARGE OVEN CAVITY

Capacity _____ 4.6 Cu. Ft.
 Bake Element _____ 3400 Watt
 Broil Element _____ 4000 Watt
 Convection Element _____ 2200 Watt
 Cobalt Blue Interior _____ Yes
 3rd Element European Convection System _____ Yes
 Self-Clean with Door Lock _____ Yes
 Oven Light _____ 2
 Eight-Pass Bake & Broil _____ Yes
 Smooth-Glide™ Racks _____ 3
 Conventional Rack _____ 1

SMALL OVEN CAVITY

Capacity _____ 2.6 Cu. Ft.
 Bake Element _____ 2100 Watt
 Broil Element _____ 3000 Watt
 Convection Element _____ 2200 Watt
 Self-Clean with Door Lock _____ Yes
 Oven Light _____ 1
 Heavy-Duty Oven Racks _____ 2

ADDITIONAL FEATURES

3" Stainless Steel Backsplash _____ Yes
 Full Stainless Steel Side Panels _____ Yes
 Professional Handle _____ Yes
 Fully Adjustable, Heavy-Duty Legs _____ Yes

ACCESSORIES

Broil Pan and Insert _____ Included
 Stainless Steel Cleaner _____ Included
 Griddle _____ Included
 Wok Ring _____ Included
 Simmer Plate _____ Included

Black Knobs

Black Burner Knob _____ Optional
 Black Thermostat Knob _____ Optional
 Black Oven Selection Knob _____ Optional

Backsplash

9" Stainless Steel – ACCBG09-48 _____ Optional
 24" Stainless Steel with
 9" Shelf – ACCBG24-48 _____ Optional
 Stainless Steel Kick Plate – KIKPLT48 _____ Optional

SPECIFICATIONS

Cutout Dimensions

Height _____ 32-5/8"
 Width _____ 48-1/8"
 Depth _____ 24"
 LP Conversion Kit _____ Included
 Voltage Rating _____ 240V / 50 Amp
 Product Weight _____ 540 Lbs.
 Shipping Weight _____ 600 Lbs.
 UPC (0-12505-) _____ 53958-9

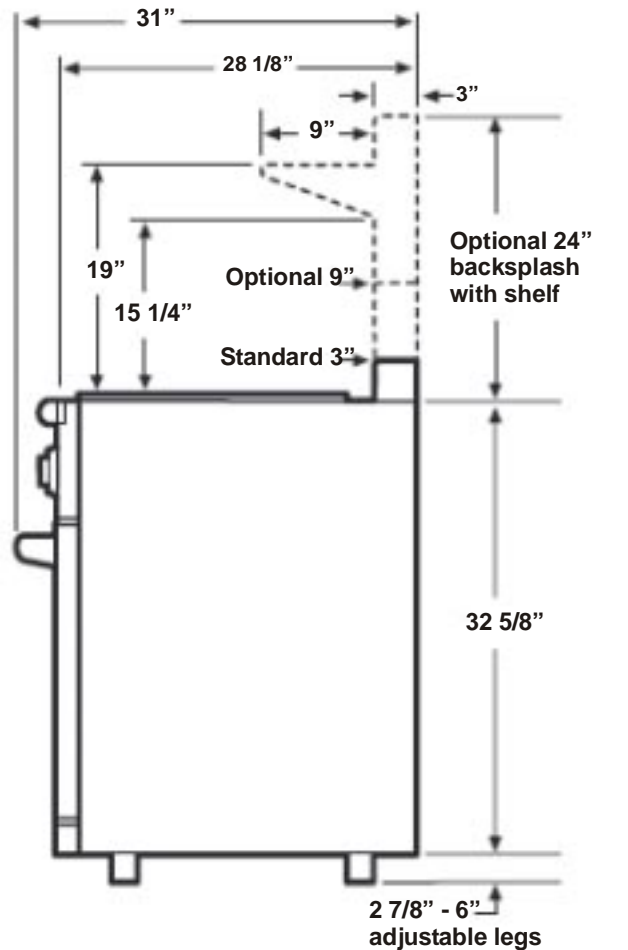

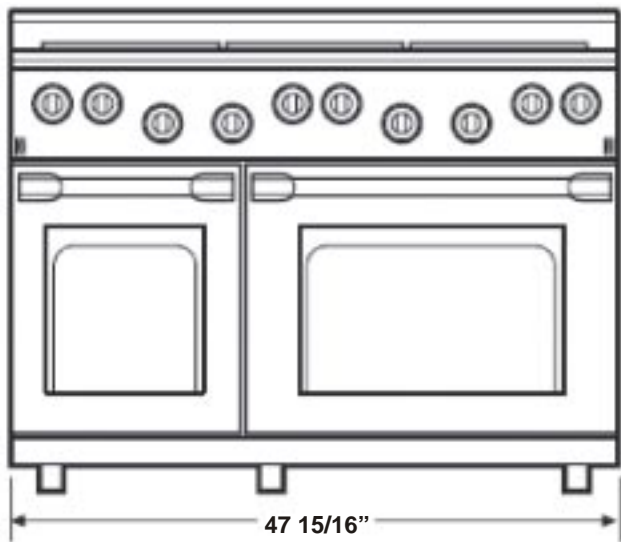

NOTE: Always consult local and / or national electric codes. Refer to Product Installation Guide for detailed installation instructions on the web at www.electroluxusa.com.

High standards of quality at Electrolux Home Products mean we are constantly working to improve our products. We reserve the right to change specifications or discontinue models without notice.

Sample wiring diagram of the large oven section

Always use the diagram with the product

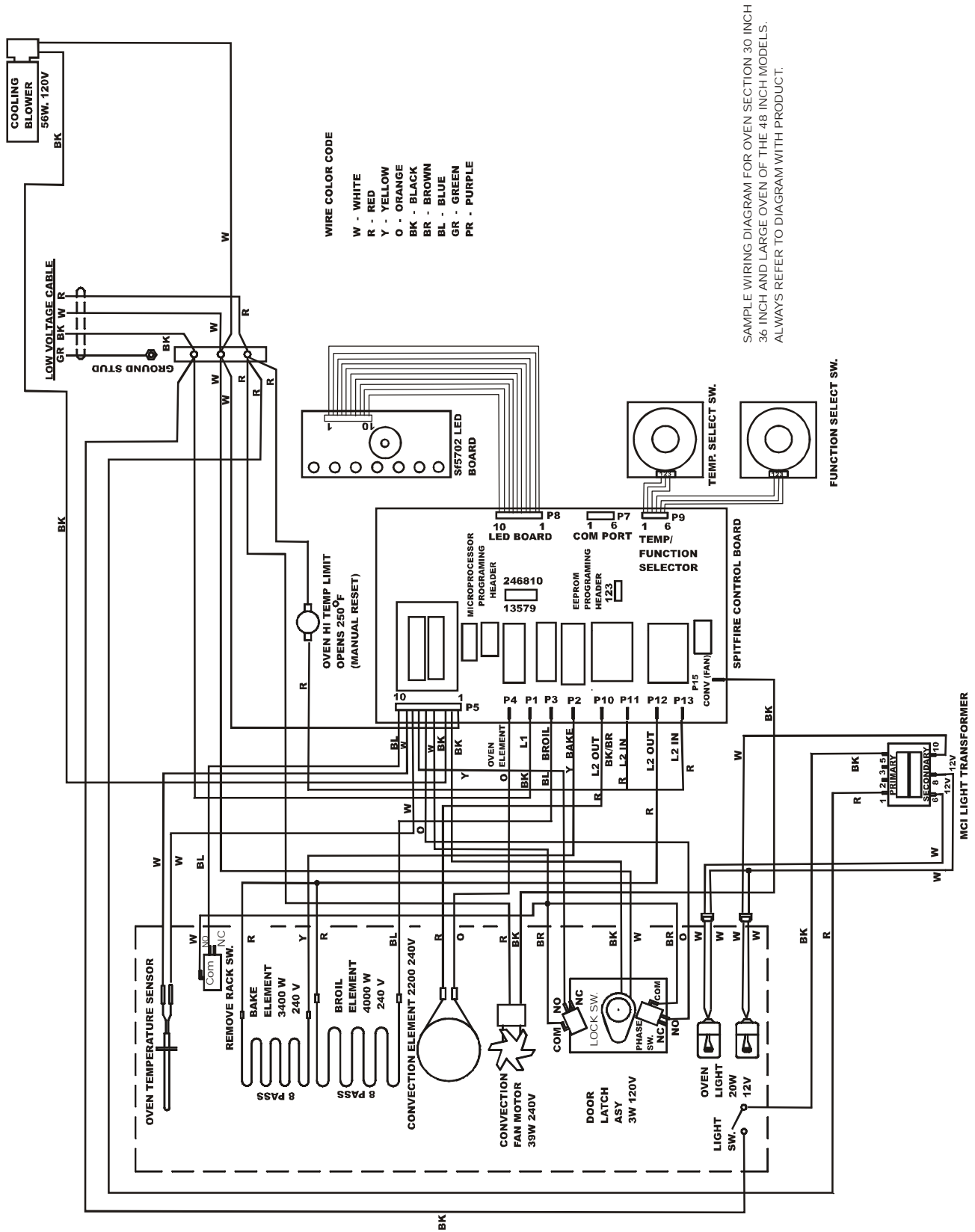

Sample wiring diagram of the small oven section

Always use the diagram with the product

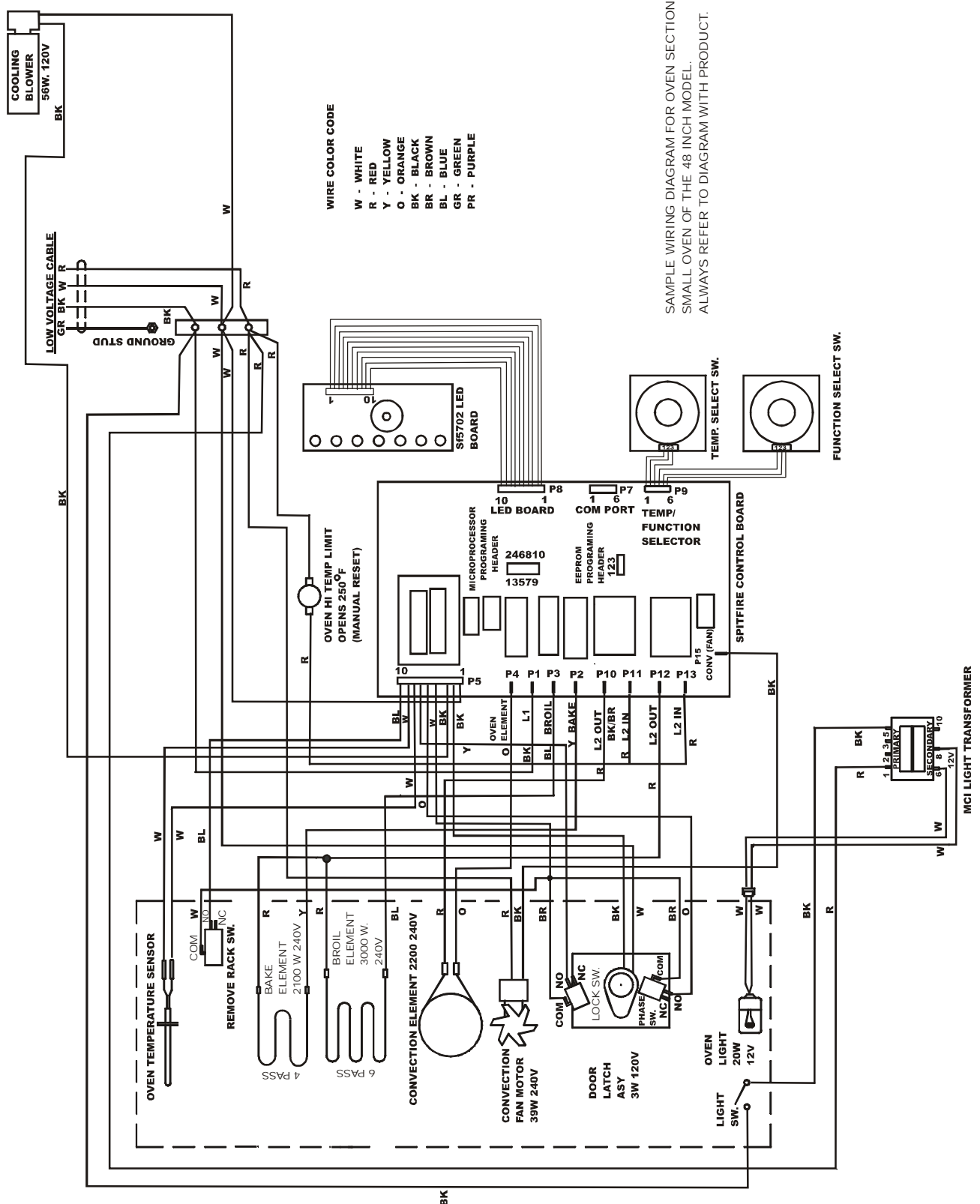

SAMPLE WIRING DIAGRAM FOR OVEN SECTION
SMALL OVEN OF THE 48 INCH MODEL.
ALWAYS REFER TO DIAGRAM WITH PRODUCT.

Sample wiring diagram of the top burner section
Always use the diagram with the product

WIRE COLOR CODE

- W - WHITE
- R - RED
- Y - YELLOW
- O - ORANGE
- BK - BLACK
- BR - BROWN
- BL - BLUE
- GR - GREEN
- PR - PURPLE

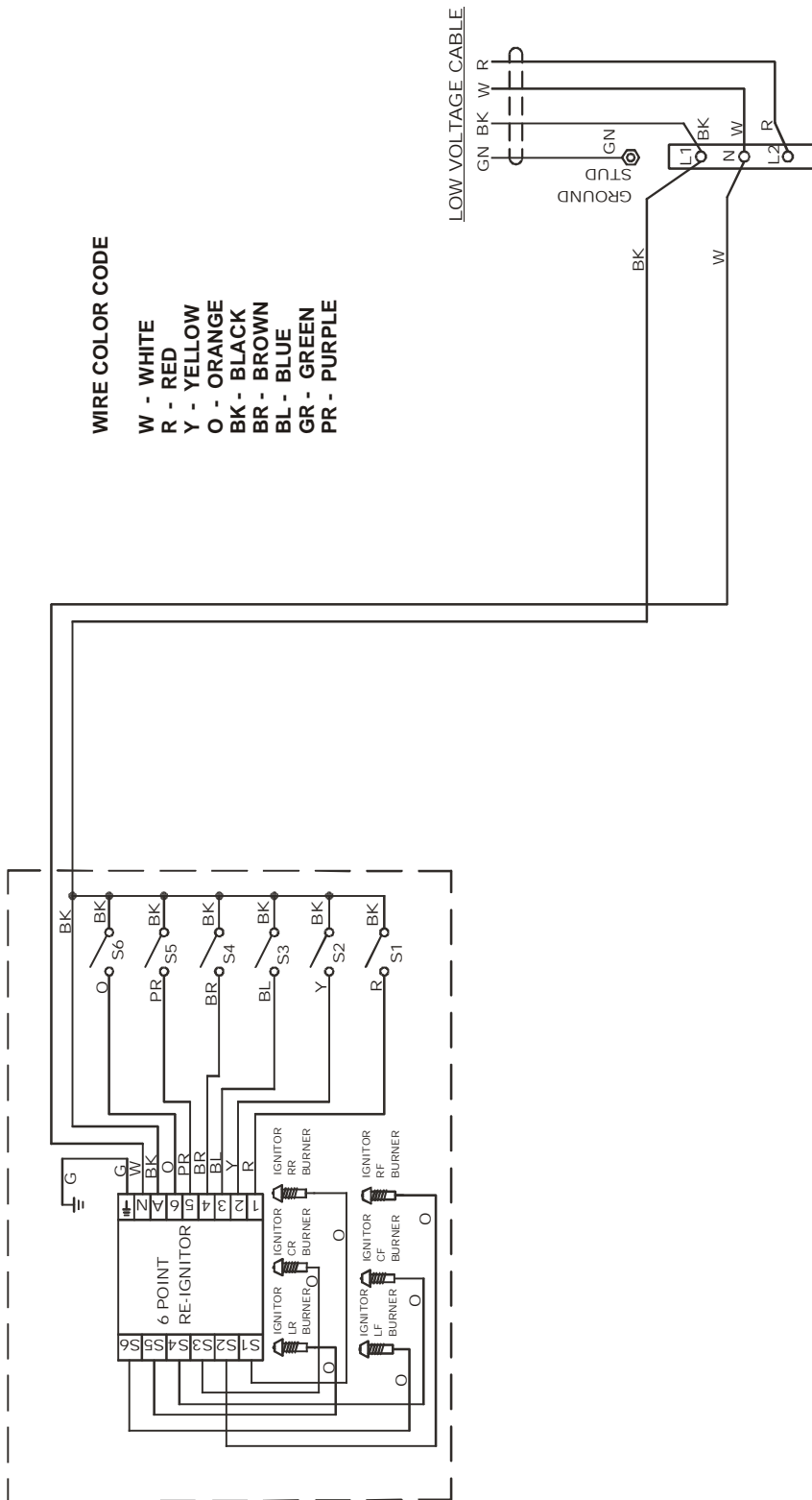

SECTION A - OWNERS GUIDE

Safety

IMPORTANT SAFETY INSTRUCTIONS

Safety Precautions

Do not attempt to install or operate your appliance until you have read the safety precautions in this manual. Safety items throughout this manual are labeled with a Warning or Caution based on the risk type.

Definitions



This is the safety alert symbol. It is used to alert you to potential personal injury hazards. Obey all safety messages that follow this symbol to avoid possible injury or death.



WARNING

WARNING indicates a potentially hazardous situation which, if not avoided, could result in death or serious injury.



CAUTION

CAUTION indicates a potentially hazardous situation which, if not avoided, may result in minor or moderate injury.

CAUTION

CAUTION used without the safety alert symbol indicates a potentially hazardous situation which, if not avoided, may result in property damage.

IMPORTANT

Indicates installation, operation or maintenance information which is important but not hazard related.

General Precautions

IMPORTANT

- Begin by ensuring proper installation and grounding of the appliance by a qualified technician according to the accompanying Installation Instructions. Have the installer show you where the fuse or junction box is located so

that you know how and where to turn off power. Also, have the installer show you the location of the gas supply. If you smell gas, do not use the range. Immediately turn off the gas supply at the shut off valve, disconnect electrical power to the unit at the fuse or junction box and contact the gas supplier or qualified appliance technician.

- Ensure that the range is used only by those individuals who are able to operate it properly.
- Use the range only for cooking tasks expected of a home appliance as outlined in this manual.
- Properly clean and maintain as recommended in this manual, cleaning only the parts listed.
- Use only dry potholders to avoid steam burns when removing hot cookware.
- In the event that a burner flame goes out and gas escapes, open a window or door. Wait at least 5 minutes before attempting to use the range.
- Select utensils of the proper size, material and construction for the particular type of cooking being done. Select utensils that are large enough to contain food without boil-overs or spillovers. Choose pans with easily grasped handles that will stay cool while cooking. Do not use utensils with loose handles. Avoid using pans that are too heavy to lift safely. Use cookware only for its intended purpose. Certain types of glass, ceramic, and earthenware utensils are suitable for use only in an oven and not in cooktop applications.
- When cooking, set the burner controls so that the flame heats only the bottom of the utensil and does not extend up the sides of the utensil.
- When deep fat frying, be certain that the pan is large enough to contain the desired volume of food without overflow caused by bubbling of the fat. Never leave a deep fat fryer unattended. Avoid deep fat frying of moist or frost-covered foods. Foods with high water content may cause spattering or spilling of the hot fat. Heat fat slowly and stir together any combinations of oils and fats prior to applying heat. Utilize a deep fat frying thermometer to avoid heating the fat to temperatures above the flash point.
- Always turn pan handles to the side or back of the cooktop. Do not turn handles towards the room where they are easily hit. Handles should

not extend over adjacent burners.

- Always check the positions of the control knobs to make sure the cooktop is off when you are finished cooking.
- Before performing any service, turn off the gas supply by closing the gas shut-off valve and turning off the electrical power supply.

IMPORTANT

- Always light each burner prior to placing a utensil on the burner grate. Also, turn the control knob to the “off” position before removing a utensil from the burner grate.
- Always clean the cooktop cautiously. If using a damp sponge or cloth, wait until the cooktop has cooled sufficiently to prevent steam burns. Also, some cleaners can produce harmful or unpleasant fumes if applied to hot surfaces.
- Clean only those parts listed in this manual.
- Keep any ventilation filters clean to avoid grease fires.
- Always set utensils gently onto the grates and center them so that they are wellbalanced.
- Always keep the cooktop surface clean and dry.
- This unit is designed as a cooking appliance. Never use it for warming or heating a room.
- Before performing any service, turn off the gas supply by closing the gas shut-off valve and turning off electrical power supply.
- Use this appliance only for its intended use as described in this manual. Do not use corrosive chemicals or vapors in this appliance. This type of appliance is not designed for industrial or laboratory use.
- Exercise caution when opening the oven door. Let hot air or steam escape before looking or reaching into the oven.
- Position oven racks in desired locations when the oven is cool. (If a rack must be repositioned after the oven is already hot, be certain that the potholder does not contact a hot heating element in the oven.)
- Before Self-Cleaning the oven, remove the

broiler pan and insert, oven racks, rack glides, convection fan filter and any other utensils.

- In the event that a burner flame goes out and gas escapes, turn off the gas control and open a window or door. Wait at least 5 minutes before attempting to use the cooktop.



CAUTION

- Do not use the range for warming or heating the room.
- Do not leave children alone or unattended in the area where the range is in use. Never allow children to sit or stand on any part of the range. Do not let children play with the range.
- Do not store items of interest to children above the range. Children could be burned or injured while climbing on the appliance.
- Do not wear loose or hanging apparel while using the range.
- Do not store combustible, flammable or explosive materials in the range or in adjacent cabinets.
- Do not leave food or cooking utensils, etc., in the oven during the self-clean cycle.
- Do not attempt to repair or replace any part of the range unless specifically recommended in literature accompanying this appliance. All other service should be referred to a qualified technician.
- Do not use water on grease fires. A violent steam explosion may result. Smother any flames with a lid, cookie sheet or flat tray. Flaming grease can be extinguished with baking soda or a multipurpose chemical or foam extinguisher.
- Do not allow potholders to touch gas burners. Do not use a towel or bulky cloth as a potholder.
- Do not use commercial oven cleaners or oven liner protective coatings on any part of the oven.
- Do not clean the door gasket, because rubbing, moving or in any way damaging the gasket, may eliminate the required tight door seal.
- DO NOT TOUCH INTERIOR SURFACES OF THE OVEN. During and after use, do not touch or let clothing or other flammable materials contact

heating elements or interior surfaces of the oven until they have had sufficient time to cool.

- Do not block or obstruct the holes beneath the control knobs. Blocking these holes may affect burner operation and may result in a hazard.
- When using the cooktop, do not touch the grates, burner caps, burner bases, or any other parts in proximity to the flame. These components may be hot enough to cause burns.
- If the range is near a window, do not use long curtains as a window treatment. They can blow over the cooktop and create a fire hazard.
- Do not cover the burners and grates with anything except properly selected utensils. Decorative covers should not be used.
- Do not heat unopened food containers such as baby food jars and cans. Pressure buildup may cause the container to burst and cause injury.
- Do not use abrasive or caustic cleaners or detergents on this appliance, as these may cause permanent damage. Do not use aerosol cleaners, as these may be flammable or cause corrosion of metal parts.
- Do not use or attempt to use this appliance in the event of a power failure.
- Do not slide cookware across the grates. Sliding may damage the finish of the grates. Lift utensils to reposition them.
- Do not allow acids (citrus juices, tomato sauces, etc.) to remain on the oven cell surfaces. The porcelain finish may stain.
- Do not touch the range top or backguard with your bare hands during all cooking and self cleaning modes. Venting from the oven may cause the backguard to become hot.

LIQUIFIED PETROLEUM (PROPANE) GAS CONVERSION

This appliance can be used with Natural Gas or Propane Gas. It is shipped from the factory for use with natural gas. A kit for converting to LP gas is supplied with your range. The kit is marked "FOR LP/PROPANE GAS CONVERSION". Follow the installation instructions which are inside the envelope.

The conversion must be performed by a qualified service technician in accordance with the kit instructions and all local codes and requirements. Failure to follow instructions could result in serious injury or property damage. The qualified agency performing this work assumes responsibility for the conversion.

WARNING

Severe shock, or damage to the range may occur if the range is not installed by a qualified installer or electrician.

CAUTION

Any additions, changes or conversions required in order for this appliance to satisfactorily meet the application needs must be made by a qualified service technician in accordance with the manufacturer's instructions and all codes and requirements of the authority having jurisdiction. Failure to follow the instructions could result in serious injury or property damage. The qualified agency performing this work assumes responsibility for the conversion.

Feature Overview

Before using your range, become familiar with the features and control panel layout. See drawing below for a detailed control panel layout for your model.

NOTE: Upon initial power being applied to the range, the function LED lights will flash while the electronic control completes its self test mode. The lights will continue flashing until the Function Knob is moved

to some other position and back to "Off". At this time the range is ready for use.

NOTE: If a power outage occurs, the above noted test sequence will take place. The function LED lights will flash. The LED lights will continue to flash until the Function Knob is moved to some other position and back to "Off". At this time the range is re-set for use.

MODEL FEATURES

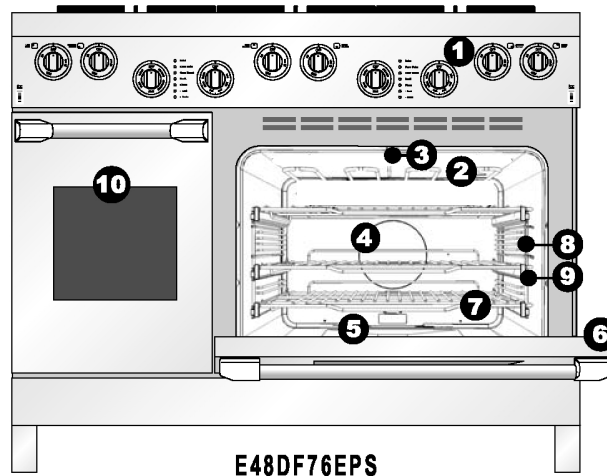
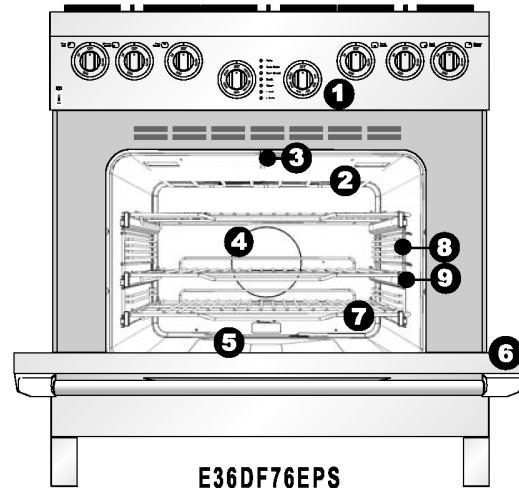
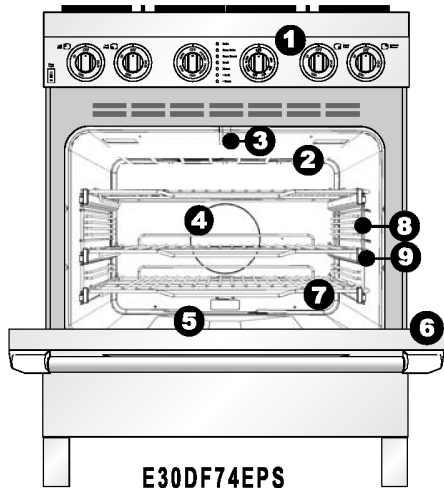

1. Control Panel
2. Broiling Element
3. Oven Door Latch
4. Convection Fan & Element
5. Bake Element
6. Oven Door
7. Oven Racks
8. Oven Rack Supports
9. Oven Rack Glides
10. Companion Oven

Cooktop Features

PROPER BURNER ADJUSTMENTS

The color of the flame is the key to proper burner adjustment. A good flame is clear, blue and hardly visible in a well-lighted room. Each cone of flame should be steady and sharply defined. Adjust or clean burner if flame is yellow-orange. To clean burner, see instructions under **General Care & Cleaning**.

BURNER LOCATIONS

All Electrolux Icon range cooktops are equipped with sealed burners. Burner configurations vary by the model number of your range. See drawing below for a detailed burner layout for your model.

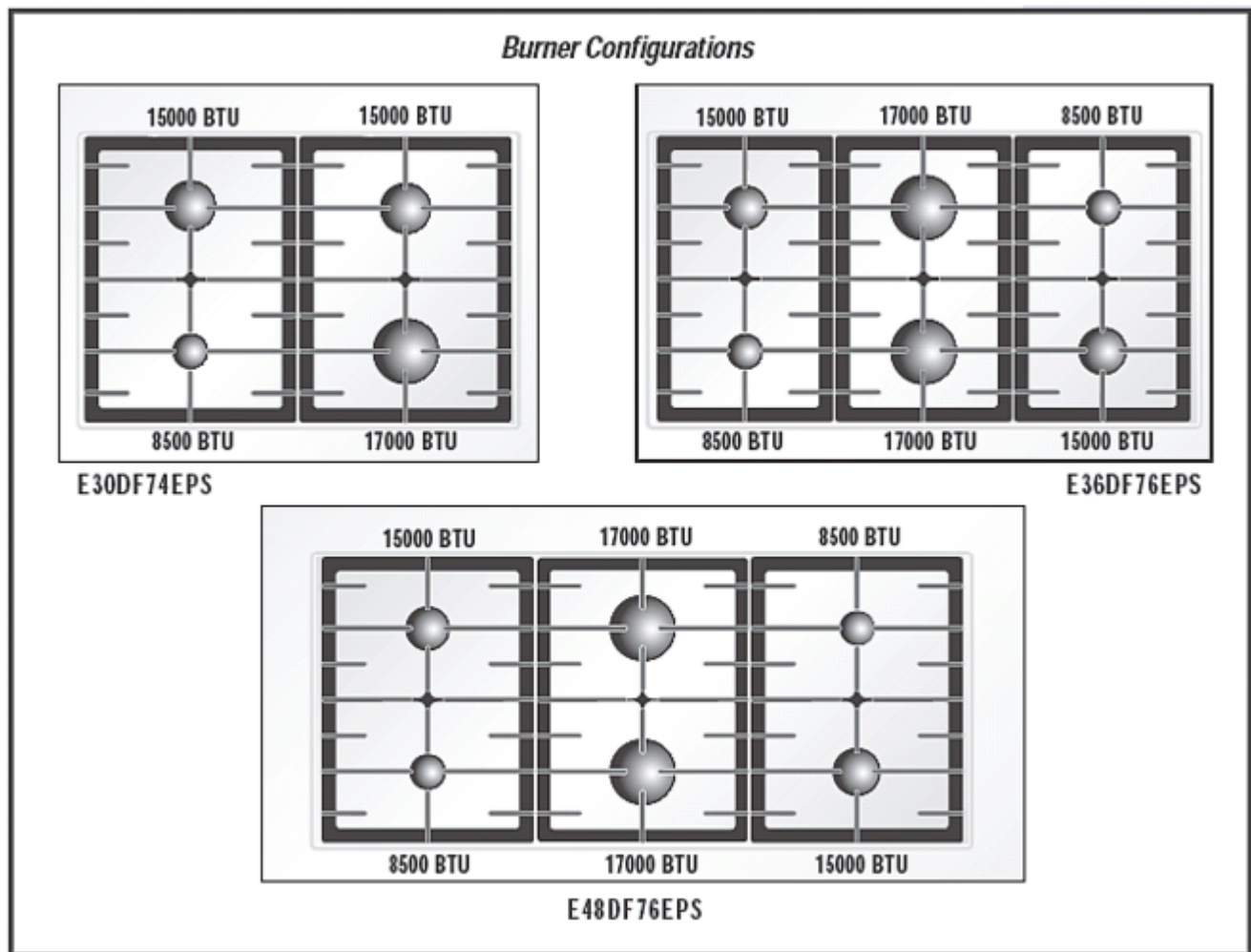

Cooktop Features

SEALED BURNER CONFIGURATIONS

On E30DF74EPS ranges, there are a total of four burners, including one burner rated at a maximum output of 17,000 BTU/HR, two burners rated at a maximum of 15,000 BTU/HR and one burner rated at a maximum output of 8,500 BTU/HR. The knobs are grouped in twos. The left two knobs operate the left two burners, and the right two knobs control the two right burners.

On E36DF76EPS and E48DF76EPS ranges, there are a total of six burners, including two burners rated at a maximum output of 17,000 BTU/HR, two burners rated at a maximum of 15,000 BTU/HR and two burners rated at a maximum output of 8,500 BTU/HR. The knobs are positioned to correspond with the burner layout.

BRASS BURNER RINGS

All burners are attached to the cooktop by retaining nuts. Gaskets around the undersides of the burner bases ensure that the burners are sealed, thereby preventing any liquid spills from entering the cooktop chassis. All spills remain on the surface of the cooktop. The brass burner heads spread the flame evenly around the burner perimeters. The burner heads must seat properly in the burner bases to enable proper cooktop operation. To ensure proper seating, positioning tabs have been placed on the bottom of each burner head to slide into corresponding notches in the fixed burner base.

BURNER IGNITORS

A burner igniter is located on each gas burner base. When a control knob is rotated more than 90 degrees counterclockwise, the igniter will spark and the selected burner will ignite. Additionally, due to Vantage Flame™, the automatic reignition feature, the igniters will spark automatically if a flame should blow out or be severely distorted by a draft or by a ventilation system. Burner igniters must always be kept clean and dry to function properly. Dirty or wet igniters will result in constant sparking, even if there is a flame present.

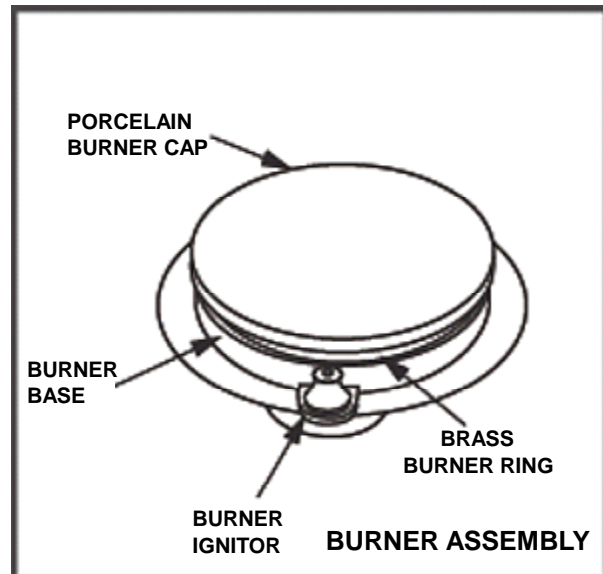

Cooktop Features/Surface Cooking

CONTROL KNOBS

The control knobs provided with this range are designed for ease of use and longevity. The "D" shaped design of the knob shaft ensures proper orientation when reinstalling the knob. Located beneath each knob is a bezel ring that mounts to the range.

PLACEMENT OF BURNER GRATES

Place grates on the porcelain coated spill tray.

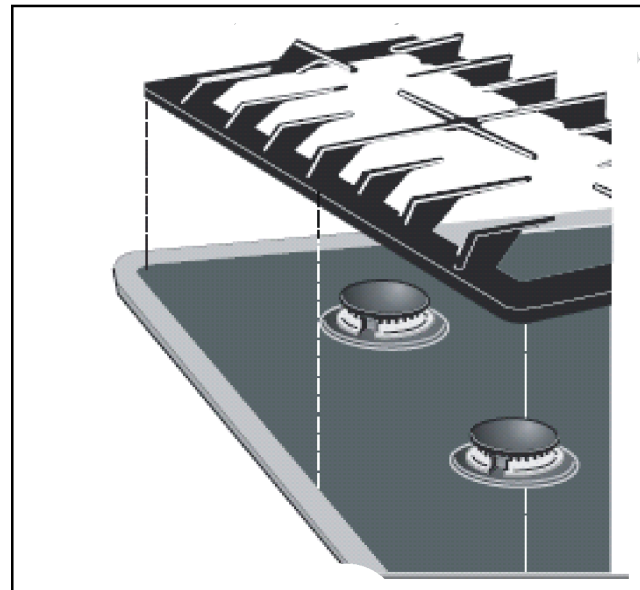

Be sure they are located correctly inside the stainless steel frame.

IMPORTANT

Do not slide the grates on the stainless steel frame. Doing so can damage the surface.

FLAME ADJUSTMENT

For most cooking, start on the highest control setting and then turn to a lower one to complete the process. Use the chart below as a guide for determining proper flame size for various types of cooking. The size and type of utensil used and the amount of food being cooked will influence the setting needed for cooking.

For deep fat frying, use a thermometer and adjust the surface control knob accordingly. If the fat is too cool, the food will absorb the fat and be greasy. If the fat is too hot, the food will brown so quickly that the center will be undercooked. Do not attempt to deep fat fry too much food at once as the food will neither brown nor cook properly.

*Flame Size	Type of Cooking
High Flame	Start most foods; bring water to a boil; pan broiling.
Medium Flame	Maintain a slow boil; thicken sauces, gravies; steam.
Low Flame	Keep foods cooking; poach; stew.

***These settings are based on using medium-weight aluminum pans with lids. Settings may vary when using other types of pans.**

Never extend the flame beyond the outer edge of the utensil. A higher flame simply wastes heat and energy, and increases your risk of being burned by the flame.

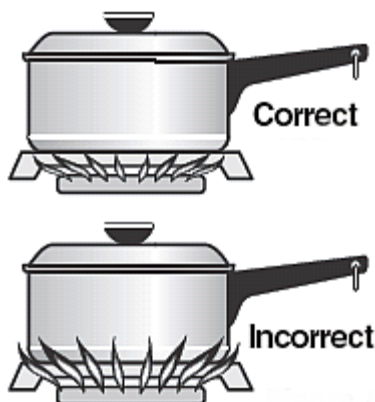

Surface Cooking

UTENSILS TO USE FOR BEST PERFORMANCE



Pans should have flat bottoms. Check for flatness by rotating a ruler across the bottom. There should be no gaps between the pan and ruler.

* Specialty pans such as lobster pots, griddles and pressure cookers may be used but must conform to the above recommended cookware requirements.

***GOOD**



- **Flat bottom** and straight sides.
- Tight fitting lids.
- Weight of handle does not tilt pan. Pan is well balanced.
- Pan sizes match the amount of food to be prepared and the size of burner.
- Made of material that conducts heat well.

POOR

- Curved and warped pan bottoms.



- Pan overhangs unit by more than 2.5 cm (1”).

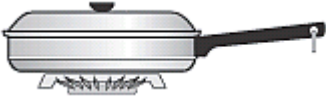

- Heavy handle tilts pan.



- Flame extends beyond unit.

Note: Always use a utensil for its intended purpose. Follow manufacturer’s instructions. Some utensils were not made to be used in the oven or on the cooktop.

Do not use pans or other cookware on the griddle. Doing so could damage the finish. With the grate in position over the burner, set the griddle on top of the grate positioning the notches in the griddle over the grate fingers

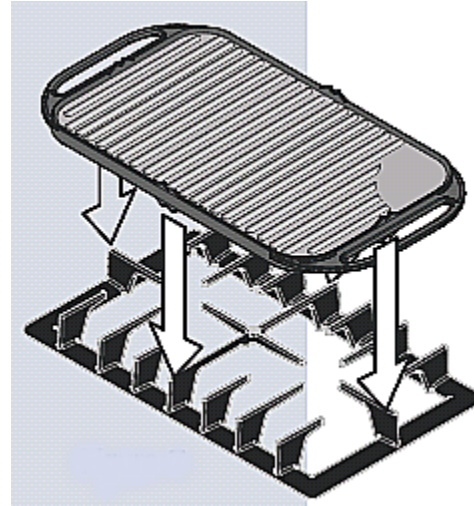

USING THE GRIDDLE

The griddle is intended for direct food cooking and can be used on both sides.



Side with grill



Flat Side

CAUTION

Always place the griddle on the grate before to turn on the burner.

Always use potholders to remove the griddle from the grate. Allow the griddle to cool before removing. Do not set hot griddle on surfaces that cannot withstand high heat; such as countertops.

Be sure the griddle is positioned correctly and stable before use to prevent hot spills and possible burns.

USING THE WOK STAND

The Wok Stand provided with your cooktop is designed to allow round-bottomed woks to be used. **It is recommended that you use a 14 inch diameter (35.5cm) or less Wok.** It is recommended that you use the right front **POWER** burner for model E30DF74EPS or center front **POWER** burner for models E36DF76EPS and E48DF76EPS with the wok stand for best performance. If properly positioned, the Wok Stand will not slide off the grate.

CAUTION

Always use potholders to remove the wok stand from the grate. Allow the wok stand to cool before removing. Do not set hot wok stand on surfaces that cannot withstand high heat; such as countertops.

Be sure the Wok Stand is positioned correctly and stable before use to prevent hot spills and possible burns.

To Properly Position the Wok Stand:

With the grate in position over the burner, set the Wok Stand on top of the grate positioning the center of the Wok Stand over the center of the cooktop grate fingers.

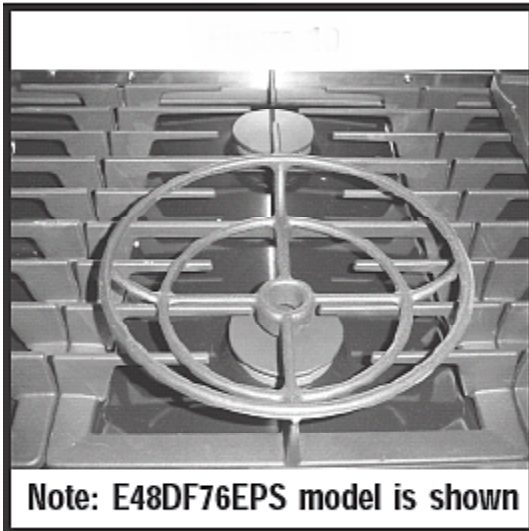

NOTE: The Wok cooking performance is best on the right front or center front POWER burner position depending on your range model.

CAUTION

Be sure to ALWAYS use the Wok Stand if the stability of the wok is uncertain. If cooking large amounts of liquid food without the Wok Stand, the wok may tip and spill over causing burns.

Flat-bottom woks with large flat bottoms may also be used on your cooktop Surface Burner Grates without the Wok Stand. Insure the stability of the flat-bottom wok before cooking without the Wok Stand. If unstable, DO NOT use the flatbottom wok without the Wok Stand.

Round-bottom woks (with a support ring) should

NOT be used. The supporting ring was not designed for proper or stable use on the Surface Burner Grates.

USING THE SIMMER PLATE

The Simmer Plate has been specifically designed for simmering and holding food at the lowest safe temperature. It can be used for cooking sauces long periods of time, or melting chocolate. With the grate in position over the burner, set the simmer plate on top of the grate, centering the plate over the grate fingers.

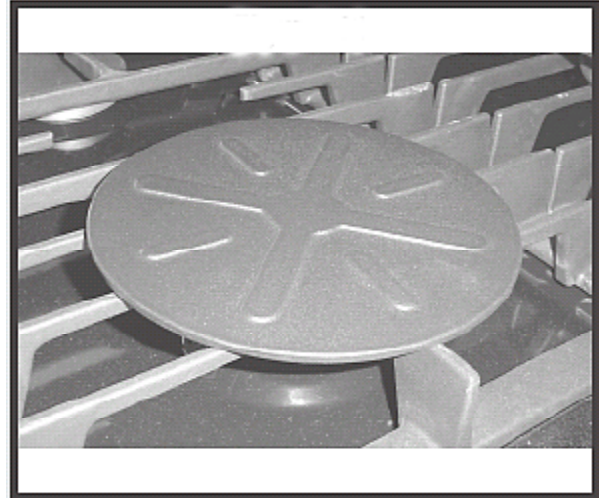

Then place the utensil on the simmer plate. The Simmer Plate is to be used by setting the burner to its lowest setting. The Simmer Plate is intended to be used for simmering only. The Simmer Plate must be removed when cooking.

CAUTION

Always place the simmer plate on the grate before turning on the burner.

Always use potholders to remove the simmer plate from the grate. Allow the simmer plate to cool before removing. Do not set hot simmer plate on surfaces that cannot withstand high heat; such as countertops.

Be sure the simmer plate is positioned correctly and stable before use to prevent hot spills and possible burns.

SETTING SURFACE CONTROLS

Your range may be equipped with any combination of the following burners:

Simmer Burner: best used for simmering delicate sauces, etc.

Standard Burner: used for most all surface cooking needs.

Large Burner: best used when bringing large quantities of liquid to temperature and when preparing larger quantities of food.

Regardless of size, always select a utensil that is suitable for the amount and type of food being prepared. Select a burner and flame size appropriate to the pan.

Never allow flames to extend beyond the outer edge of the pan.

Your cooktop is also equipped with 300° rotation flame control valves. These valves provide enhanced control of the burner flame.

Each burner lights automatically from an electric ignitor when its control knob is turned to the **LITE** position.



CAUTION

Do not place plastic items such as salt and pepper shakers, spoon holders or plastic wrappings on top of the cooktop when it is in use. These items could melt or ignite. Potholders, towels or wood spoons could catch fire if placed too close to a flame.

Operation

BEFORE COOKING

Ensure that the range has been installed by a qualified individual who has tested the operation of the range in accordance with the Installation Instructions. The brass burner rings, burner caps, grates, knobs and spill protectors must be in place for the cooktop to operate properly. All range components must be clean. Be certain that the gas and electrical power supplies to the range are operational.

Read this **Use and Care Manual** in its entirety prior to operating the range.

OPERATING THE CONTROL VALVES

To light a particular burner, press in on the corresponding control knob, then immediately rotate the knob counterclockwise from the “OFF” position to the “**LITE HI**” position. **The burner igniters will spark continuously until the gas ignites on the selected burner. The igniters will stop sparking as soon as the burner ignites.**

Once the burner is lit, reduce the flame height if desired by rotating the control knob further counterclockwise, then place the utensil on the grate.

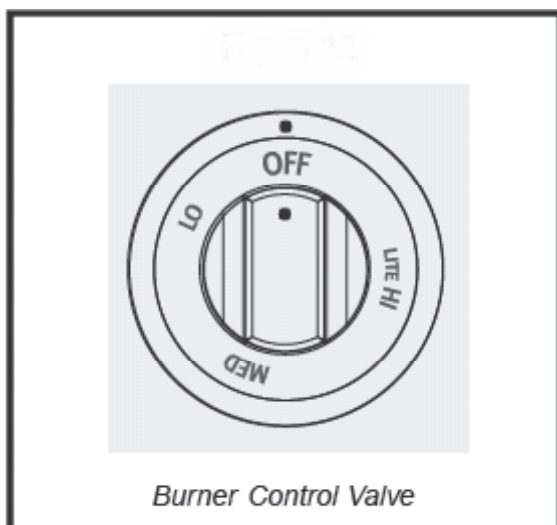

WARNING

Do not touch any burner cap, burner base, or igniter while the igniters are sparking, as an electrical shock could result.

IMPORTANT

- If the gas does not ignite within four seconds, turn off the valve. Allow at least two minutes for any gas to dissipate, then repeat the lighting procedure.
- Burner igniters must always be kept clean and dry to function properly. Due to the Vantage-Flame™ reignition feature, dirty or wet igniters will result in constant sparking, even if there is a flame present. Additionally, igniters will spark automatically if the flame is distorted by a draft or by a cooktop ventilation system. Eliminate the draft or reduce the ventilation blower speed in this case.
- When the cooktop is cool and/or more than two burners are in use, the igniters may continue to spark if the control knob is set to the “LOW” position. This is normal until the burner warms up. The tendency to spark under these conditions can be reduced by operating the burner at a higher flame setting for a short period of time (normally 60 seconds or less), then adjusting the control knob down to the “LOW” setting. The burner will also warm up faster if a utensil is placed on the grate.
- The flame should be steady and blue in color. Foreign material in the gas line, especially in new construction, may cause an orange flame during initial operation. This will disappear with further use.
- The flame should burn evenly around the perimeter of the burner. If the flame is uneven, ensure that the brass burner ring and porcelain burner cap are properly positioned, then check for any foreign material in the burner ring or on the burner cap. Remove any foreign material with a straightened paper clip, wire, or needle. Do not use a toothpick to remove clogs, as it could break off. Do not damage the brass or distort the shape of the burner ring ports.
- Never light the burners with a match or other open flame. If a burner does not ignite, refer to the Troubleshooting Guide.

SETTING THE BURNER FLAME HEIGHT

Setting the proper burner flame height for the desired cooking process and selected utensil will result in superior cooking performance, while also saving time

and energy. Follow these recommendations for best results:

1. Use low or medium flame heights when cooking in utensils that are poor conductors of heat, such as glass, ceramic, and cast iron cooking vessels. Reduce the flame height until it covers approximately 1/3 of the utensil diameter. This will ensure even heating within the utensil and reduce the likelihood of burning or scorching of food.
2. Reduce the flame if it is extending beyond the bottom of the utensil. A flame that licks along the sides of the utensil is potentially dangerous, heats the utensil handle and kitchen instead of the food, and wastes energy.
3. Reduce the flame height to the minimum level necessary to perform the desired cooking process. Remember that food cooks just as quickly at a gentle boil as it does at a vigorous, rolling boil. Maintaining a higher boil than is not necessary wastes energy, cooks away moisture, and causes a loss in food flavor and nutrient level.

ENERGY SAVING TIPS

- Always use utensils with flat, smooth bottoms and tight-fitting lids to retain heat and moisture.
- Minimize the amount of liquid or fat to reduce cooking times.
- Select cookware of the proper size, material and construction for the cooking process being performed.
- Adjust the flame height to fit the utensil size.
- After liquid reaches a boil, reduce the heat to maintain a simmer rather than a rolling boil.
- Use a timer rather than repeatedly removing the lid to check food.
- Thaw foods prior to cooking to reduce cooking time.

Getting Started

BEFORE SETTING OVEN CONTROLS

Installing and Removing Oven Rack Supports

ALWAYS INSTALL OVEN RACK SUPPORT BEFORE TURNING ON THE OVEN (WHEN THE OVEN IS COOL).

To install oven rack support, align and insert the 2 rear tabs of the rack supports to the rear holes in the oven side wall.

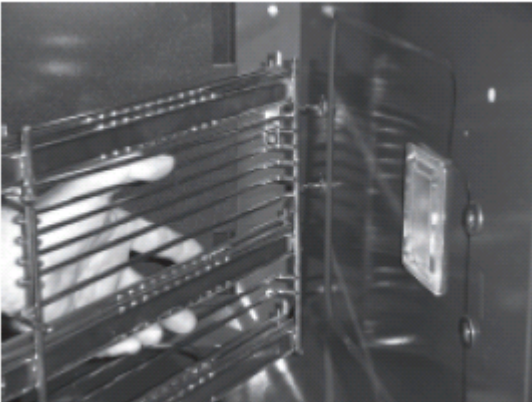

Then align the 2 front tabs of the rack support to the front holes in the oven side wall. Push in on rack supports to secure in wall.

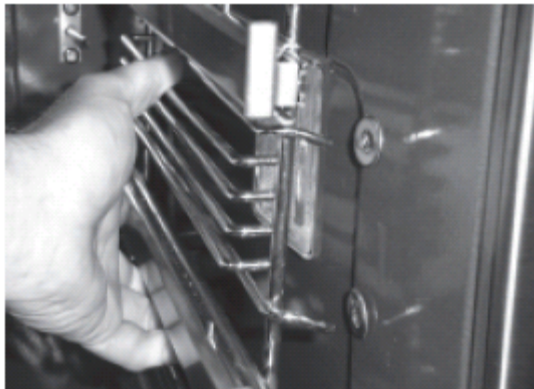

To remove the oven rack support for a self-clean cycle, support and lift front bottom of rack support to release front tabs. Then, rotate rack support up and out to release rear tabs. If the rack supports are not removed, the self-clean cycle won't start.

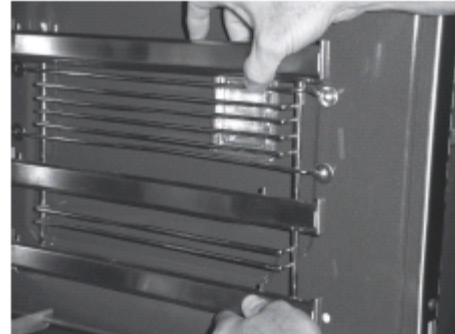

Removing and Replacing Oven Racks

ALWAYS ARRANGE OVEN RACKS WHEN THE OVEN IS COOL (PRIOR TO OPERATING THE OVEN).

Always use oven mitts when using the oven. **To remove an oven rack**, pull the rack forward. Lift up the rack off the oven rack glides. **To install an oven rack**, locate the two pinholes in the small plates at the front corners of the rack. Position the back of the rack on the rack glides and drop the pin holes over the pins on the rack glides.



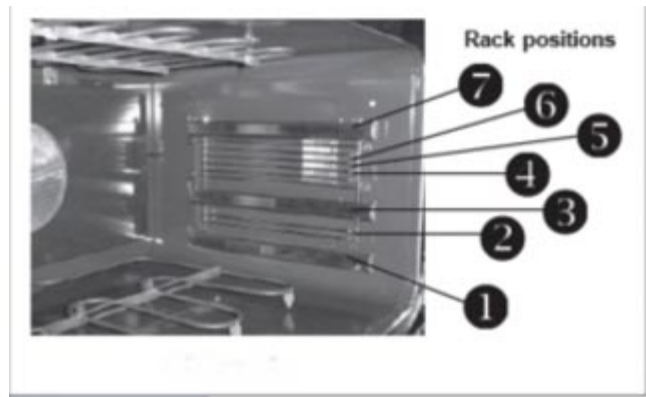
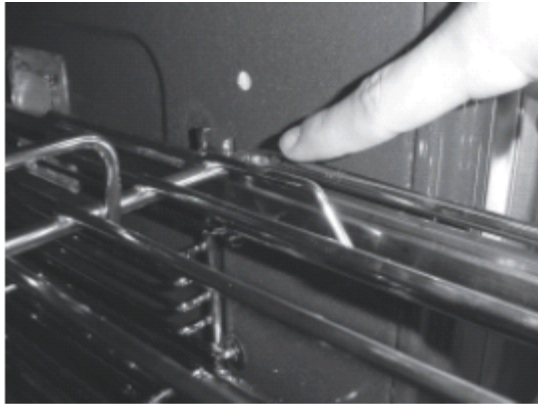

RECOMMENDED RACK POSITIONS FOR BROILING, BAKING & ROASTING

Food Rack	Position
Broiling meats, chicken or fish _____	5, 6 or 7
Cookies, cakes, pies & muffins _____	3 or 4
Frozen pies, angel food cake, yeast, bread, casseroles, small cuts of meat or poultry _____	2
Turkey, roast or ham _____	1

Note: Always use caution when removing food.

Arranging Oven Racks

ALWAYS ARRANGE OVEN RACKS WHEN THE OVEN IS COOL (PRIOR TO OPERATING THE OVEN).

Three chrome-plated Smooth-Glide™ oven racks and one chrome plated conventional oven rack are provided with your range.

To bake on a single rack, place the rack in position 3.

To bake on 2 racks, place the racks in position 2 and 7. **To bake on 3 racks,** place the racks in position 1, 3 and 7.

Baking Layer Cakes with 1 or 2 Oven Racks

For best results when baking cakes or cookies using 2 oven racks, place cookware on rack positions 2 and 7.

For best results when using a single oven rack, place cookware on rack position 3.

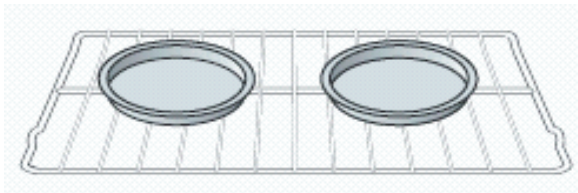

Air Circulation in the Oven

For best air circulation and baking results allow 2-4" (5-10 cm) around the cookware for proper air circulation and be sure pans and cookware do not touch each other, the oven door, sides or back of the oven cavity. The hot air must be able to circulate around the pans and cookware in the oven for even heat to reach around the food.

COMPANION OVEN (FOR E48DF76EPS)

The E48DF76EPS includes a companion oven, which is a fully featured, selfcleaning, convection oven.

Following are a few notes about cooking in this oven:

- Since the oven's capacity is much smaller, you may find that cook times are slightly faster. Items cook faster in this oven as far as roasting and baking.
- Follow the same guidelines as the large oven on selecting baking modes for best results.
- When broiling food, position food 4-6 inches from broil element. Preheat the broil element for 5 to 10 minutes for best results.
- There are 5 heights for positioning the oven racks on the porcelain rack supports. Three chrome-plated racks are provided for this oven.
- A 9"x12" or 10"x14" cooking utensil is recommended for use in this oven. This includes baking sheets and pans for multiple rack convection baking.

NOTE: Oven racks should be removed when using the Self-Clean feature. The porcelain oven rack supports DO NOT need to be removed.

Setting Oven Controls

SELECTOR KNOB FUNCTIONS

Read the instructions carefully before using the oven. For satisfactory use of your oven, become familiar with the various functions of the oven as described below.

E30DF74EPS

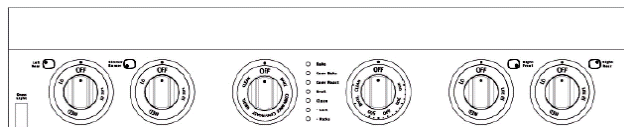

E36DF76EPS

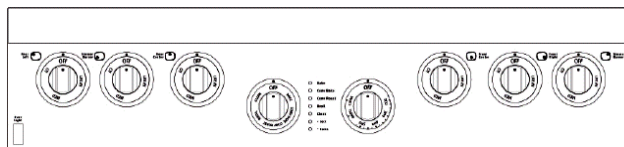

E48DF76EPS

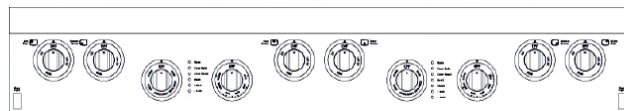

Setting Oven Controls

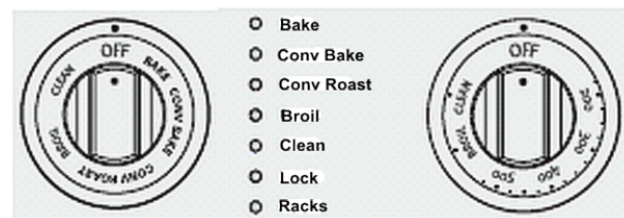

OVEN FUNCTIONS

All oven functions are described below:

Standard Bake-With the Standard Bake function, the bottom heat element provides conventional baking heat.

Temperatures may be set from 170° F to 500° F. Use Standard Bake for single rack baking or roasting.

Convection Bake-With the Convection Bake function, a third heating element, encircling the convection fan located in the rear of the oven chamber, acts as the heat source. The convection fan draws air from the oven chamber, then forces it across the hot convection heating element. The heated air is directed back onto the oven chamber through the convection baffle. The baffle

distributes the heated air evenly to ensure uniform results. Temperatures may be set from 170° F to 500° F. Use this function for single rack baking, multiple rack baking, roasting, and preparation of complete meals.

Convection Roast - In this combination convection/radiant function, the bake, broil and convection elements provide the heat. As in Convection Bake, the convection fan and baffle combine to circulate the heated air evenly throughout the oven chamber. Temperature may be set from 170° F to 500° F. Use this function for roasting.

Standard Broil - The high wattage, top heating element supplies the heat when using the broil function. **Broiling is performed with the oven door closed.**

Self Clean - With the pyrolytic Self Clean function, the oven reaches extreme high temperatures, thereby burning off oven soil automatically. The Self Clean time is 3 hours.

Cooking Instructions

BAKING

This cooking mode is for normal baking, roasting or warming. The temperature control knob can be set at any temperature from 170°F to 500°F.

To set the Bake Temperature to 350°F:

1. Arrange interior oven racks to desired positions.
2. Turn selector knob to Bake.
3. The corresponding LED light will flash.
4. Turn temperature control knob to 350°F.
5. The LED light will stop flashing and the oven will begin to preheat.

A beep will sound once the oven temperature reaches 350°F. The LED light will remain on until the Selector knob is turned to the **off** position or the temperature control knob is turned to the **off** position.

To change the Bake temperature (example changing from 350°F to 425°F):

- 1 After the oven has already been set at 350°F, and the oven temperature needs to be changed to 425°F, turn the temperature control knob to 425°F. A beep will sound when the oven temperature reaches 425°F.

BAKING PROBLEMS

For best cooking results preheat the oven before baking cookies, breads, cakes, pies or pastries, etc... There is no need to preheat the oven for roasting meats or baking casseroles. The cooking times and temperatures needed to bake a product may vary slightly from your previous appliance.

Baking Problems and Solutions Chart		
Baking Problems	Causes	Solutions
Cookies and biscuits burn on the bottom.	<ul style="list-style-type: none"> • Cookies and biscuits put into the oven before the preheating time is completed. • Oven rack overcrowded or rack position too low. • Dark pan absorbs heat too fast. 	<ul style="list-style-type: none"> • Allow oven to preheat to the selected temperature before placing food in oven. • Choose pan sizes that will permit (2" to 4") of air space on all sides when placed in the oven. • Use a medium-weight aluminum baking sheet.
Cakes too dark on top or bottom.	<ul style="list-style-type: none"> • Cakes put into the oven before preheating time is completed. • Rack position too high or low. • Oven too hot. 	<ul style="list-style-type: none"> • Allow oven to preheat to the selected temperature before placing food in the oven. • Use proper rack position for baking needs. • Set oven temperature 25°F lower than recommended.
Cakes not done in the center.	<ul style="list-style-type: none"> • Oven too hot. • Incorrect pan size. • Pan not centered in oven. 	<ul style="list-style-type: none"> • Set oven temperature 25°F lower than recommended. • Use pan size suggested in recipe. • Use proper rack position and place pan so there is 2" to 4" of space on all sides of pan.
Cakes not level.	<ul style="list-style-type: none"> • Range not level. • Pan too close to oven wall or rack overcrowded. • Pan warped. 	<ul style="list-style-type: none"> • Place a marked glass measuring cup filled with water on the center of the oven rack. If the water level is uneven, refer to the installation instructions for leveling the wall oven. • Be sure to allow 2" to 4" of clearance on all sides of each pan in the oven. • Do not use pans that are dented or warped.
Foods not done when cooking time is up.	<ul style="list-style-type: none"> • Oven too cool. • Oven overcrowded. • Oven door opened too frequently. 	<ul style="list-style-type: none"> • Set oven temperature 25°F higher than suggested and bake for the recommended time. • Be sure to remove all pans from the oven except the ones to be used for baking. • Open oven door only after shortest recommended baking time.

CONVECTION BAKING

As a general rule, convection baking will allow preparation of most foods at reduced temperatures for shorter periods of time, while producing superior results.

Typically, you can reduce standard bake temperatures by 25°F and cook for 10% to 25% less time. **When using the convection bake mode, the temperature is automatically reduced by the electronic oven control**, so the oven cooking temperature should be set to the temperature the recipe recommends.

In the convection bake mode, a third heating element, encircling the convection fan located in the rear of the chamber, acts as the heat source. The convection fan draws air from the oven chamber, and then forces it across the hot convection element. The heated air is directed back into the chamber through the convection baffle. The baffle distributes the air evenly to ensure uniform results. Temperatures may be set from 170°F to 500°F.

General Convection Bake Instructions

- 1 When using convection bake, decrease your normal cooking time by 25% to start. Time reductions will vary depending on the amount and type of food to be cooked.
- 2 Baking pans with no sides or very low sides should be used to bake on so heated air can be allowed to circulate around the food. Food baked on a darker finish will cook faster.

To set the oven for Convection Bake and temperature to 350°F:

- 1 Arrange oven racks to desired position.
- 2 Turn selector knob to Convection Bake.
- 3 The corresponding LED light will flash.
- 4 Turn temperature control knob to 350°F.
- 5 The LED light will stop flashing, and the oven will begin to preheat. A beep will sound once the oven temperature reaches 350°F. The LED light will remain on until the Selector knob is turned to the **off** position or the temperature control knob is turned to the **off** position.

To change the Convection Bake temperature (example changing from 350°F to 425°F):

- 1 After the oven has already been set at 350°F, and the oven temperature needs to be changed to 425°F, turn the temperature control knob to 425°F. A beep will sound when the oven temperature reaches 425°F.

CONVECTION ROASTING

All baking modes can be used to successfully roast in your oven. However, the Convection Roast mode is recommended to produce meats that are deliciously seared on the outside and succulently juicy on the inside in record time.

Foods that are exceptional, when prepared in the Convection Roast mode include: beef, pork, ham, lamb, turkey chicken and Cornish hens.

When preparing meats for convection roasting, use the broiler pan and insert along with the roasting rack. The roasting rack will allow the heat to circulate around the meat.

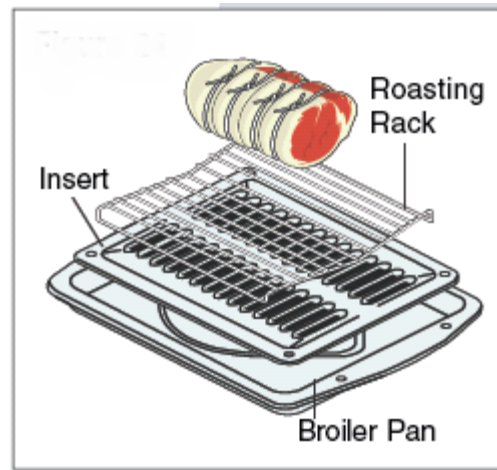

General Convection Roast Instructions

- 1 When using convection roast, decrease your normal cooking time by 25% to start. Time reductions will vary depending on the amount and type of food to be cooked.
- 2 Using a roasting rack, always roast meats fat side up in a shallow pan. Always use a pan that fits the size of the food being prepared. The broiler pan and insert can be used in most cases. No basting is required when the fat side is up. Do not add water to the pan. It will cause a steamed effect. Roasting is a dry heat process.

- 3 Poultry should be placed breast side up, on a rack in a shallow pan that fits the size of the food. Again, the broiler pan and insert accompanying the oven can be used. Poultry can be basted with butter, margarine or oil before and during roasting.
- 4 For Convection Roasting, pans with tall sides are not recommended. They interfere with the circulation of heated air over the food.
- 5 When using a meat thermometer, insert the probe half way into the center of the thickest portion of the meat. (For poultry, insert the thermometer probe between the body and leg into the thickest part of the inner thigh). To ensure an accurate reading, the tip of the probe should not touch the bone, fat or gristle. Check the meat thermometer 2/3 of the way through the recommended roasting time. After reading the meat thermometer once, insert it a ½ inch further, then take a second reading. If the second reading registers below the first, continue cooking the meat.
- 6 Remove meats from the oven when the thermometer registers 5°F to 10°F below the desired temperature. The meat will continue to cook after removal. Allow 15 to 20 minutes after roasting in order to make carving easier.
- 7 Convection Roast is not recommended for meats or poultry cooked with a cooking bag, foil tent or other cover. Food cooked with these methods will produce better results when using the Bake mode.
- 8 Roasting times will always vary according to the size, shape and quality of meats and poultry. Less tender cuts of meat are best prepared in the Bake mode and may require moist cooking techniques. Follow your favorite cookbook recipes.
- 9 Reduce spatter by lining the bottom of the roasting pan with lightly crushed aluminum foil.

To set the oven for Convection Roast and temperature to 350°F:

- 1 Arrange oven racks to desired position.
- 2 Turn selector knob to Convection Roast.
- 3 The corresponding LED light will flash.
- 4 Turn temperature control knob to 350°F.
- 5 The LED light will stop flashing, and the oven will begin to heat.

NOTE: THERE IS NO AUTOMATIC PREHEAT WITH THIS MODE.

The LED light will remain on until the Selector knob is turned to the **off** position or the temperature control knob is turned to the **off** position.

To change the Convection Roast temperature (example changing from 350°F to 425°F):

- 1 After the oven has already been set at 350°F, and the oven temperature needs to be changed to 425°F, turn the temperature control knob to 425°F.

BROILING

Broiling is a method of cooking tender cuts of meat by direct heat under the broil element of the oven. Broiling in the oven is accomplished with the oven door closed. It is normal and necessary for some smoke to be present to give the food a broiled flavor.

Preheating

Preheating is suggested when searing rare steaks. (Remove the broiler pan before preheating. Foods will stick if placed on hot metal.) To preheat, set the control to BROIL. Wait for the element to become red-hot, usually about 2 minutes. Preheating is not necessary when broiling meats well-done.

To Broil

Broil one side until the food is browned; turn and cook on the second side. Season and serve. Always pull the rack out to the “stop” position before turning or removing food.

Broiling Tips

The broiler pan and its insert allow dripping grease to drain and be kept away from the high heat of the broiler.

Broiling Times

Use the following table for approximate broiling times. Increase or decrease broiling times, or move the broil-

ing pan to a different rack position to suit for doneness. If the food you are broiling is not listed in the table, follow the instructions provided in your cookbook and watch the item closely.

Oven Broiling Recommendations					
Food Item	Rack Position	Knob Setting	Cook Time		Doneness
			1st side	2nd side	
Steak 1" thick	6 or 7	BROIL	6:00	4:00	Rare
	6 or 7	BROIL	7:00	5:00	Medium
Pork Chops 3/4" thick	6 or 7	BROIL	8:00	6:00	Well
Chicken - Bone In	4	BROIL	20:00	10:00	Well
Chicken - Boneless	6 or 7	BROIL	8:00	6:00	Well
Fish	6 or 7	BROIL	13:00	n/a	Well
Shrimp	4	BROIL	5:00	n/a	Well
Hamburger 1" thick	6 or 7	BROIL	9:00	7:00	Medium
	4	BROIL	10:00	8:00	Well

NOTE: DO NOT use the broiler pan without its insert. DO NOT cover the broiler pan insert with foil. The exposed grease could ignite.



CAUTION

Should an oven fire occur, turn off the oven. If the fire continues, throw baking soda on the fire or use fire extinguisher. **DO NOT put water or flour on the fire. Flour may be explosive.**

Setting Broil

The selector knob controls the Broil feature. When broiling, heat radiates downward from the oven broiler for even coverage. The Broil feature temperature is 500°F. The broil pan and broil pan insert used together allow dripping grease to drain and be kept away from the high heat of the oven broiler. **DO NOT use the broil pan without the insert. DO NOT cover the broil pan insert with foil.** The exposed grease could catch fire.



WARNING

Should an oven fire occur, leave the oven door closed and turn off the oven. If the fire continues, throw baking soda on the fire or

use a fire extinguisher. DO NOT put water or flour on the fire. Flour may be explosive and water can cause a grease fire to spread and cause personal injury.

To set the oven to broil:

- 1 Place the broiler pan insert on the broiler pan. Then place the food on the broiler pan insert. **DO NOT** use the broiler pan without the insert. **DO NOT** cover the broiler insert with foil. The exposed grease could ignite.
- 2 Arrange the interior oven rack and place the broiler pan on the rack. Be sure to center the broiler pan directly under the broiler element. If preheating the broil element first, position the broiler pan with food after step 5.
- 3 Turn selector knob to Broil.
- 4 The corresponding LED light will flash.
- 5 Turn temperature knob to Broil. The LED light will remain on until the selector knob is turned to the off position or the temperature control knob is turned to the off position.

Broiler Clean-Up Tips:

To make cleaning easier, line the bottom of the broiler pan with aluminum foil. **DO NOT** cover the broiler pan insert with foil.

To prevent grease from baking on, remove the broiler pan from the oven as soon as cooking is completed. Use hot pads because the broiler pan is extremely hot. Pour off grease. Soak the pan in **HOT**, soapy water. The broiler pan and insert can be cleaned in your dishwasher.

Clean the broiler pan as soon as possible after each use. If necessary, use soap-filled steel wool pads. Heavy scouring may scratch the broiler pan insert.

USING THE OVEN SELF-CLEAN FEATURE

Adhere to the Following Cleaning Precautions:

- Allow the oven to cool before cleaning.
- Wear rubber gloves when cleaning any exterior parts of the oven manually.



During the Self-Cleaning cycle, the outside of the range can become very hot to the touch. DO NOT leave a small children unattended near the appliance.

Before cleaning any part of the oven, be sure the oven is turned off. Wait until the oven is cool.



The health of some birds is extremely sensitive to the fumes given off during the Self-Clean cycle of any range. Move birds to another well ventilated room.

DO NOT use oven cleaners or oven protective coatings in or around any part of the Self-Cleaning oven. **DO NOT** clean the oven door gasket. The gasket on the oven door is essential for a good seal. Care should be taken not to rub, damage or move the gasket. **DO NOT** use any cleaning materials on the gasket. Doing so could damage it. **DO NOT** use **aluminum foil** to line the oven bottom. This may affect cooking or foil could melt and damage the oven surface.

Preparing the Oven for Self-Cleaning

1. **Remove any excess spillovers** in the oven cavity **before** starting the Self-Cleaning cycle. To clean, use hot soapy water and a cloth. Large spillovers

can cause smoke or a fire when subjected to high temperatures. **DO NOT** allow food spills with a high sugar or acid content (such as tomatoes, sauerkraut, fruit juices or pie filling) to remain on the surface as they may leave a dull spot even after cleaning.

2. Clean any soil from the oven frame and the door liner. These areas heat sufficiently during a self-clean to burn soil on. Clean with hot soapy water.
3. Remove the broiler pan and insert, all utensils and any foil. These items cannot withstand high cleaning temperatures.
4. Oven racks and oven rack supports must be removed. If they are not removed, the Self-Cleaning cycle cannot start and the “- Racks” LED will begin to flash indicating that you must remove the racks and racks glides with the supports before starting the clean cycle. The convection filter also needs to be removed. When the cycle has finished and the door can be opened, replace the oven rack glides with supports, oven racks and convection filter.

NOTE: For model E48DF76ESP, the racks and convection filter need to be removed from the companion oven. Self-Clean can only be run in the large oven or the companion oven separately. The Self-Clean cycle can not be run simultaneously in both ovens.

STARTING THE OVEN SELF-CLEAN CYCLE

The selector knob controls the Self-Cleaning feature. If you are planning to use the oven immediately after a self-clean cycle remember to allow time for the oven to cool down and the oven door to unlock. This normally takes about one hour. A 3-hour self-clean cycle will actually take about 4 hours to complete.



During the Self-Cleaning cycle, the outside of the appliance can become very hot to the touch. DO NOT leave small children unattended near the appliance; they may be burned if they touch the hot oven door surfaces.



DO NOT force the oven door open. This can damage the automatic door locking system. Use care when opening the oven door after the self-cleaning cycle. Stand to the side of the oven when opening

the door to allow hot air or steam to escape. The oven may still be VERY HOT.

To start a Self-Cleaning cycle:

1. Be sure oven is empty and the oven door is closed.
2. Turn selector knob to Self Clean.
3. The corresponding LED will flash.
4. Turn temperature knob to Clean.
5. The LED for "Lock" will flash while transitioning from unlock to lock. It will stop flashing when the door is locked.

NOTE: If the "- Racks" LED is flashing when the clean mode is initiated, the oven racks and rack glides with supports have not been removed. It will discontinue flashing, once the selector knob is set back to the off position and the racks and rack glides with supports are removed from the oven (not applicable to model E48DF76EPS companion oven).

6. As soon as the controls are set to clean, the motor driven oven door lock will begin to close automatically. Once the door has been locked the indicator light will stop flashing and remain on. Allow about 30 seconds for the oven door lock to close.

CLEANING TIPS FOR RANGE COOKTOP

No maintenance, other than the **Care and Cleaning** identified in this **Use & Care Manual**, should be attempted by the owner/operator. All other maintenance and service must be performed by a qualified appliance technician.



WARNING

To avoid electrical shock or burns, turn off all controls and ensure the cooktop is cool before cleaning.

IMPORTANT

Do not use harsh or abrasive cleaning agents, waxes, polishes, or commercial cooktop cleaners to clean the cooktop.

Read and follow the **Care and Cleaning** instructions to ensure that proper cooktop operation and appearance will be maintained throughout the lifetime of the

product. Several materials and finishes are used in the cooktop. Each material and finish must be properly cleaned according to the following recommendations. Failure to follow these recommendations may result in permanent damage to the cooktop.



WARNING

- **Before cleaning the cooktop, ensure that all burners are turned off and that all components are cool enough to safely touch.**
- **After cleaning, reassemble all components before attempting to operate the cooktop.**

Proper cleaning is necessary to maintain cooktop performance and appearance, while also ensuring safe operation. The cleaning effort necessary to maintain the cooktop varies according to the type and amount of cooking. For example, more frequent cleaning is required if the cooktop is used often for frying or other high temperature operations.

Clean the cooktop thoroughly prior to operating it the first time. For initial and everyday cleaning, use a soft cloth or sponge lightly dampened with a solution of warm water and hand dishwashing liquid to clean all components.

Recommendations for cleaning and care of specific cooktop components are summarized below:

IMPORTANT

The grates and burner caps, unlike other porcelain enamel appliances in your home, are exposed to extremely high temperatures in a matter of seconds. In addition to this extreme thermal shock, the grates are subjected to mechanical shock when utensils are placed on or slid across them. Finally, spills introduce foods with high acidity to all of the porcelain components. Due to these severe operating conditions, all porcelain enamel components on the cooktop will undergo an inevitable change in appearance with use. Meticulous care and cleaning will slow but not eliminate this natural and expected aging process.

Treating the porcelain components with care will slow the natural deterioration that takes place with cooktop use. Please follow these guidelines to keep the porcelain parts looking their best:

1. Do not use utensils having rough bottoms, as this can result in permanent damage to the top surfaces of the porcelainized grates.

2. Do not drop utensils onto the grates or drag heavy pots across the tops of the grates.
3. Set the grates into the locating dimples gently. Do not drop the grates into place.
4. Use caution when cooking to avoid spills as much as possible. Porcelain is acid-resistant but not acid-proof, so some foods can cause permanent damage if allowed to remain on porcelain surfaces.

Daily cleaning of the grates, burner heads, and burner caps is best accomplished with a soft cloth or sponge dampened in a solution of warm water and hand dishwashing liquid. Grates are dishwasher safe. Burner caps should not be cleaned in the dishwasher.

Stubborn stains may be removed by applying full-strength, all purpose cleaning sprays. (If you are unable to locate these cleaning compounds, please phone the Electrolux Customer Service Department for a referral.)

Mildly abrasive cleaners or applicators, such as soap-filled steel wool pads, may be used with extreme care on occasion to remove the most serious stains. **Exercise caution – extensive use of abrasives will eventually damage the porcelain enamel surface.**

CLEANING STAINLESS STEEL SURFACES

Clean these surfaces with the provided Stainless Steel Cleaner. Rinse and dry with a soft lint-free cloth.

IMPORTANT

If commercially available stainless steel cleaners are used, it is important to read the labels for chlorine compounds. Chlorine is a corrosive substance. If these compounds are present, rinse thoroughly and dry with a soft lint-free cloth.

Always wipe stainless steel surfaces with the grain.

CLEANING PORCELAIN GRATES

Clean the porcelain grates with a solution of mild detergent and hot water. Rinse with a soft cloth. Do not use abrasives or commercial oven cleaners.

Stubborn stains may be removed by washing the grates in a dishwasher, using normal dishwashing detergent.

IMPORTANT

Never use the cooktop surface as a cutting board. Do not use abrasive cleaners or applicators on the cooktop.

Do not try to remove heavy spills with a sharp object such as a knife or metal spatula. Sharp objects may scratch the cooktop.

A small amount of baby oil may be applied to stainless steel tops to restore the lustre.

CLEANING KNOBS AND KNOB BEZELS

The control knobs provided with this cooktop are designed for ease of use and longevity. The “D” shaped design of the knob shaft ensures proper orientation when reinstalling the knob and knob bezels.

The knobs are made of a composite plastic. These components should be washed regularly in warm, soapy water. Hand dishwashing liquid is excellent for this task. Knobs should be removed by gently pulling them straight out and off of the valve shafts. Use caution to avoid introduction of moisture into the control panel behind the bezels. To replace knobs, align the “D-shaped” opening at the bottom of the knob with the “D-shaped” valve shaft, then carefully press the knob onto the valve.

CLEANING BURNER BASES

The burner base is permanently attached to the cooktop. The base should be wiped clean using a soft cloth or sponge that has been lightly dampened with warm water and hand dishwashing liquid. Thoroughly clean and dry the igniters to prevent constant sparking of the reignition system. Refer to the **Cleaning the Burner Igniters** section for cleaning tips.

IMPORTANT

- **Turn the knobs to the “OFF” position prior to removing them from the valve stems.**
- **The cooktop should never be operated without the knobs in place.**
- **Do not soak the knobs in water or place them in the dishwasher.**
- **Do not expose the knobs to direct flame, hot utensils, or other sources of heat.**
- **Do not use abrasive or corrosive cleaners or applicators, as these could cause permanent damage.**

CLEANING BURNER RINGS

The brass burner rings spread the flame evenly around the burner perimeters. The burner rings must seat properly in the burner bases to enable proper cooktop operation. To ensure proper seating, positioning tabs have been placed on the bottom of each burner ring to slide into corresponding notches in the fixed burner base.

To remove the burner ring, first remove the grate, then lift off the porcelain burner cap. The burner ring may then be removed from the burner base. Soak the burner ring in a warm solution of hand dishwashing liquid and water, then rinse well with clean water. Dry the burner thoroughly

Stubborn stains may be removed by applying a metal polishing compound. (If you are unable to locate this type of polishing compound, please phone the Electrolux Customer Service Department for a referral.)

CLEANING THE BURNER IGNITERS

Under certain cooking or cleaning conditions, your cooktop igniters may become coated with or corroded by food deposits, splattered grease or cleaning agents. **This condition can cause erratic or continuous sparking.** Keeping the igniters clean and dry will help to reduce this problem. To avoid unnecessary and costly service calls, the homeowner should perform periodic cleaning of the igniters.

To clean the igniters:

1. Be sure the burners are cool to the touch. Remove the grate, burner cap and burner heads.
2. Clean completely around the igniter, including over and under the edge of the metal cap and base. Use care while cleaning here. Parts of the igniter are porcelain and can be fragile.
3. **DO NOT USE WATER** when cleaning the igniters. If a liquid must be used to clean the igniter effectively, use only a small amount of rubbing alcohol.
4. After cleaning, reinstall the burner ring, burner cap and grate. Make sure the brass burner ring is properly seated into the burner base.
5. Test the burners. If erratic clicking is still present, make sure the igniter is completely dry.

If the unit still exhibits problems after drying, please phone the Electrolux Customer Service Department for further assistance.

GENERAL CLEANING

Cleaning Various Parts of Your appliance

Before cleaning any part of the appliance, be sure all controls are turned OFF and the appliance is COOL. REMOVE SPILLOVERS AND HEAVY SOILING AS SOON AS POSSIBLE. REGULAR CLEANING WILL REDUCE THE NUMBER OF MAJOR CLEANINGS LATER.

Surfaces	How to Clean
Painted and Plastic Body Parts and Decorative Trim.	<p>Using a soft cloth, clean with mild dish detergent and water or a 50/50 solution of vinegar and water. Follow by rinsing the area with clean water; dry and polish with a soft cloth.</p> <p>Glass cleaners may be used if sprayed on a soft cloth first. DO NOT spray liquids directly on the control pad and display area. Do not use large amounts of water on the control panel - excess water on the control area may cause damage to the appliance.</p> <p>Do not use other liquid cleaners, abrasive cleaners, scouring pads, or some paper towels - they will damage the finish.</p>
Control Panel	<p>Before cleaning the control panel, turn all controls to OFF. Glass cleaners may be used if sprayed on a soft cloth first. DO NOT spray liquids directly on the control pad and display area. Wipe with a soft cloth or paper towel. DO NOT use abrasive cleaners or scouring pads. These can permanently damage the control panel surface.</p>
Porcelain Enamel Broiler Pan, Broiler Pan Insert and Cooktop Spill Tray	<p>Gentle scouring with a soapy scouring pad will remove most spots. Rinse with a 1:1 solution of clear water and ammonia. If necessary, cover difficult spots with an ammonia-soaked paper towel for 30 to 40 minutes. Rinse with clean water and a damp cloth, and then scrub with a soap-filled scouring pad. Rinse and wipe dry with a clean cloth. Remove all cleaners or the porcelain may become damaged during future heating.</p>
Stainless Steel, Chrome Decorative Trim, Oven Racks, Oven Racks Support	<p>Clean with hot, soapy water and a dishcloth. Rinse with clean water and a cloth. Cover stubborn spots with an ammonia-soaked paper towel for 30 to 40 minutes. Rinse. Cleaners made especially for stainless steel are recommended. Be sure to rinse the cleaners as bluish stains may occur during heating and cannot be removed.</p>
Oven Racks	<p>Oven racks and oven rack supports must be removed from the oven during the selfclean cycle for cleaning. If they are not removed, the self-clean cycle will not start. Clean them as described above.</p>
Oven Door	<p>To clean oven door, wash with hot, soapy water and a clean cloth. DO NOT immerse the door in water or clean the oven door gasket. DO NOT use abrasive cleaners on the inside of the oven door glass.</p>
Oven Door Gasket	<p>The oven door gasket is located on the oven door and visible when the door is opened. This gasket is essential for a good seal. Care should be taken not to rub, damage or remove the gasket.</p>

OVEN LIGHT

Your new range has halogen oven lights to enhance the view into the oven. The light assembly consists of a removable lens cover and 20-watt 120VAC halogen bulb (OSRAM - Part Number 64428), as well as a light fixture housing. Light bulb replacement is considered to be a homeowner maintenance operation.



To prevent electrical shock and/or personal injury: Make certain that the oven and light bulb are cool and that power to the oven has been turned off before replacing the light bulb.

Always ensure that the lens cover is in place when using the oven. The lens cover protects the bulb from breakage caused by high oven temperatures or mechanical shock.

To replace the light bulb:

1. Turn off the power at the main power supply.
2. Remove rack supports in order to access the light housing.
3. Remove the lens cover from the housing by pulling straight out.
4. Replace halogen bulb taking care not to touch the bulb. If you touch the halogen bulb with your finger, body oils can shorten the bulb life.
5. To replace glass shield, reverse the procedure.

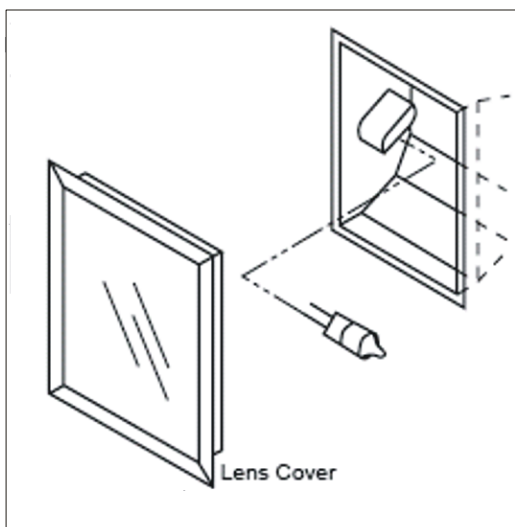

Solutions to Common Problems

PROBLEM	POSSIBLE CAUSE	SOLUTION
Nothing works.	Oven is not connected to electrical power.	Have oven connected to a properly sized electrical power supply by a qualified technician.
	Power supply is not energized.	Have an electrician check power supply, including the house circuit breaker, wiring and fuses.
Oven will not heat.	Oven settings are not correct.	Follow mode selection and temperature settings as specified in OVEN OPERATION.
Foods overcooked.	Incorrect cooking time, temperature.	Adjust time, temperature or rack position.
Oven does not Self-Clean.	Door is not closed tightly, so the automatic door latch will not lock.	Close door tightly.
	Oven control knob set incorrectly.	Follow mode selection and temperature settings specified for SELF-CLEAN.
Oven light will not work.	Light bulb is burned out.	Follow REPLACING THE OVEN LIGHT.
Door will not open.	Oven is in Self-Clean mode.	If oven is hot, door latch will release automatically when oven temperature falls below 490°F at end of cycle.
Oven will not heat after Self-Clean.	Oven settings not correct.	Follow mode selection and temperature settings as specified in OVEN OPERATION.
Igniters do not spark.	Circuit breaker is tripped.	Reset circuit breaker.
	House fuse is blown.	Replace house fuse.
	Power outage in local area.	Contact power company.
Sparking but no flame ignition.	Gas shut-off valve is in the "off" position.	Turn shut-off to "on" position.
	Gas supply is interrupted.	Contact gas company.

PROBLEM	POSSIBLE CAUSE	SOLUTION
Burners ignite but flame is extremely large, distorted or yellow.	<p>Burner ring ports are clogged.</p> <p>Burner ports or burner caps are not positioned properly.</p> <p>Cooktop is being operated on the wrong type of gas.</p> <p>Regulator is not installed, is faulty or is set for the wrong type of gas.</p>	<p>Clean burner ring ports with straightened paper clip, needle or wire.</p> <p>Remove and carefully re-install burner rings and caps.</p> <p>Ensure that the type of cooktop matches the gas supply (natural gas or L.P. gas)</p> <p>Check installation, replace regulator, or set regulator for proper gas.</p>
Burner flame goes out at low setting.	Low gas supply pressure.	Contact gas company.
Ignitors spark continuously after flame ignition.	<p>Power supply is not grounded.</p> <p>Power supply polarity is reversed.</p> <p>Ignitors are wet or dirty.</p>	<p>Have power supply properly grounded.</p> <p>Have polarity corrected.</p> <p>Dry or clean ignitors.</p>

Service Failure Mode definitions

Failure Mode Definition							
Front Panel LED							Failure Description
1	2	3	4	5	6	7	
X				X			Runaway Temperature
X					X		Incorrect Micro ID
X						X	Incorrect EEPROM Checksum
		X		X			Open Temperature Probe
		X			X		Shorted Temperature Probe
	X		X				Max Unlock Time Exceeded (Motor Door Latch)
	X			X			Max Unlock Attempts.Exceeded (Motor Door Latch)
	X				X		Max Lock Time Exceeded (Motor Door Latch)
	X	X				X	Max Lock Attempts.Exceeded (Motor Door Latch)
	X	X	X				Motor Door Latch Failed During Clean Operation
			X				Inter Processor Communications Failure (Motor Door Latch)
LED Definitions							
1 - Bake				5 - Clean			
2 - Convection Bake				6 - Lock			
3 - Convection Roast				7 - Remove Racks			
4 - Broil							

SAMPLE WARRANTY ALWAYS REFER TO WARRANTY WITH PRODUCT

RANGE WARRANTY *Your range is protected by this warranty*

In the U.S.A., your appliance is warranted by Electrolux Home Products North America, a division of White Consolidated Industries, Inc. We authorize no person to change or add to any of our obligations under this warranty. Our obligations for service and parts under this warranty must be performed by us or an authorized Electrolux Home Products North America servicer. In Canada, your appliance is warranted by Electrolux Canada Corp.

	WARRANTY PERIOD	THROUGH OUR AUTHORIZED SERVICERS, WE WILL:	THE CONSUMER WILL BE RESPONSIBLE FOR:
FULL ONE-YEAR WARRANTY	One year from original purchase date.	Pay all costs for repairing or replacing any parts of this appliance which prove to be defective in materials or workmanship.	Costs of service calls that are listed under NORMAL RESPONSIBILITIES OF THE CONSUMER. *
LIMITED WARRANTY (Applicable to the State of Alaska)	Time periods listed above.	All of the provisions of the full and limited warranties above and the exclusions listed below apply.	Costs of the technician's travel to the home and any costs for pick up and delivery of the appliance required because of service.

***NORMAL RESPONSIBILITIES OF THE CONSUMER**

This warranty applies only to products in ordinary household use, and the consumer is responsible for the items listed below:

1. Proper use of the appliance in accordance with instructions provided with the product.
2. Proper installation by an authorized servicer in accordance with instructions provided with the appliance and in accordance with all local plumbing, electrical and/or gas codes.
3. Proper connection to a grounded power supply of sufficient voltage, replacement of blown fuses, repair of loose connections or defects in house wiring.
4. Expenses for making the appliance accessible for servicing, such as removal of trim, cupboards, shelves, etc., which are not a part of the appliance when it was shipped from the factory.
5. Damages to finish after installation.
6. Replacement of light bulbs and/or fluorescent tubes (on models with these features).

EXCLUSIONS

This warranty does not cover the following:

1. CONSEQUENTIAL OR INCIDENTAL DAMAGES SUCH AS PROPERTY DAMAGE AND INCIDENTAL EXPENSES RESULTING FROM ANY BREACH OF THIS WRITTEN OR ANY IMPLIED WARRANTY.
NOTE: Some states do not allow the exclusion or limitation of incidental or consequential damages, so this limitation or exclusion may not apply to you.
2. Service calls which do not involve malfunction or defects in workmanship or material, or for appliances not in ordinary household use. The consumer shall pay for such service calls.
3. Damages caused by services performed by servicers other than Electrolux Home Products North America or its authorized servicers; use of parts other than genuine Electrolux Home Products parts; obtained from persons other than such servicers; or external causes such as abuse, misuse, inadequate power supply or acts of God.
4. Products with original serial numbers that have been removed or altered and cannot be readily determined.

IF YOU NEED SERVICE

Keep your bill of sale, delivery slip, or some other appropriate payment record. The date on the bill establishes the warranty period should service be required. If service is performed, it is in your best interest to obtain and keep all receipts. This written warranty gives you specific legal rights. You may also have other rights that vary from state to state. Service under this warranty must be obtained by contacting Electrolux Home Products:

USA
1•800•944•9044
 Electrolux Home Products
 North America
 P.O. Box 212378
 Augusta, GA 30917

Canada
1•866•294•9911
 Electrolux Home Products
 North America
 802, boul. L'Ange-Gardien
 L'Assomption, Québec
 J5W 1T6

This warranty only applies in the 50 states of the U.S.A., Puerto Rico, and Canada.
 Product features or specifications as described or illustrated are subject to change without notice. All warranties are made by Electrolux Home Products North America, a division of White Consolidated Industries, Inc.
In Canada, your appliance is warranted by Electrolux Canada Corp.

SECTION B - INSTALLATION INSTRUCTIONS

Safety

IMPORTANT SAFETY INSTRUCTIONS

Safety Precautions

Do not attempt to install or operate your appliance until you have read the safety precautions in this manual. Safety items throughout this manual are labeled with a Warning or Caution based on the risk type.

Definitions



This is the safety alert symbol. It is used to alert you to potential personal injury hazards. Obey all safety messages that follow this symbol to avoid possible injury or death.



WARNING

WARNING indicates a potentially hazardous situation which, if not avoided, could result in death or serious injury.



CAUTION

CAUTION indicates a potentially hazardous situation which, if not avoided, may result in minor or moderate injury.

CAUTION

CAUTION used without the safety alert symbol indicates a potentially hazardous situation which, if not avoided, may result in property damage.

IMPORTANT

Indicates installation, operation or maintenance information which is important but not hazard related.

SAFETY PRECAUTIONS



WARNING

- Read all instructions before using the appliance.
- Improper installation, adjustment, alteration,
- service, or maintenance can cause personal injury or property damage. Refer to these instructions and the accompanying Use & Care Manual. For assistance or additional information, consult a qualified installer, service agency, manufacturer (dealer), or the gas supplier.
- For your safety:
 - Do not store or use gasoline or other flammable vapors and liquids in the vicinity of this or any other appliance.
 - Do not obstruct the flow of combustion and ventilation air to the unit.
 - Keep appliance area clear and free from combustible material, gasoline and other flammable vapors and liquids.
 - Do not use or attempt to use this appliance in the event of a power failure.
- This unit is designed as a cooking appliance. Never use it for warming or heating a room.
- This appliance must not be used in combination with surface (countertop) ventilation systems. The use of an overhead hood or downdraft is recommended for ventilation.
- This appliance must be installed with the gas pressure regulator supplied with it.
- Disconnect the electrical supply before installing or servicing the appliance.
- This appliance must be grounded. Connect only to a properly grounded electrical supply. Refer to "Electrical Requirements".
- Install or locate this appliance only in accordance with these installation instructions.
- Use this appliance only for its intended use as described in this manual. Do not use corrosive chemicals or vapors in this appliance. This type of appliance is not designed for industrial or laboratory use.
- As with any appliance, close supervision is necessary when used by children.
- Do not operate this appliance if it has a damaged electrical cord, plug, conduit or wires, if it is not working properly, or if it has been

damaged or dropped.

- This appliance should be serviced only by qualified service personnel.
- Some products, such as whole eggs, and sealed containers, such as closed glass jars, may explode and should not be heated on this cooktop.



WARNING

- Based on safety considerations, the top burner flame should be adjusted so it does not extend beyond the edge of the cooking utensil.
- If the information in this manual is not followed exactly, a fire or explosion may result causing property damage, personal injury, or death.
- What to do if you smell gas:
 - Do not try to light any appliance.
 - Do not touch any electrical switch, do not use any phone in your building.
 - Immediately call the gas supplier from a neighbor's phone.
 - Follow the gas supplier's instructions.
 - If you cannot reach your gas supplier, call the fire department.
- Installation of this appliance must be performed by a qualified installer, service agency or the gas supplier.

Finding Information

READ AND SAVE THESE INSTRUCTIONS

NOTE: Installer: Leave instructions with owner.

NOTE: Owner: Read your Range Use & Care Manual. It contains important safety information for operating this appliance. It also has many suggestions for getting the best results from your Range.

Read all instructions before installing the Range.

For your safety, please read and observe all safety instructions. This guide will help you anticipate all installation connections.

QUESTIONS?

For toll-free telephone support in the U.S. and Canada: **1-877- 4ELECTROLUX (1-877-435-3287)**

For online support and Internet product information: **www.electroluxusa.com.**

Preparing for Installation

VERIFY PACKAGE CONTENTS

- Use & Care Manual
- Burner Rings
- Broiler Pan/Insert
- Wok Ring
- Anti-tip Bracket
- Simmerplate
- Grate Pack
- Stainless Steel Cleaner
- Griddle
- Roasting Rack
- LP Conversion Kit
- Burner Cap Pack

GAS SUPPLY REQUIREMENTS

Check your local building codes for the proper method of installation. In the absence of local codes, this appliance should be installed in accordance with the National Fuel Gas Code ANSI Z223.1. Be certain that the appliance being installed is correct for the gas service being provided. Refer to the rating label located on the kick panel and/or the table below for gas supply requirements.

GAS AND ELECTRIC REQUIREMENTS TABLE

Refer to the following table for more information on gas and electric requirements.

Model No.	Electrical circuit required	Total connected load	Gas type	Manifold pressure	Minimum gas supply pressure
E30DF74EPS	240-4 Wire VAC, 60Hz, 30A	26.4 Amps (6.3 Kw)	Natural	4" Water Column	5" Water Column
			Liquid Propane	10" Water Column	11" Water Column
E36DF76EPS	240-4 Wire VAC, 60Hz, 30A	26.4 Amps (6.3 Kw)	Natural	4" Water Column	5" Water Column
			Liquid Propane	10" Water Column	11" Water Column
E48DF76EPS	240-4 Wire VAC, 60Hz, 50A	44.2 Amps (10.4 Kw)	Natural	4" Water Column	5" Water Column
			Liquid Propane	10" Water Column	11" Water Column

NOTE: This range is shipped from the factory pre-set for use with natural gas. For LP conversion see the accompanying LP Conversion Kit. The electrical information in the table is also located on the serial number label on the range. It can be found by opening the oven door and looking through the inlet air cooling grill.

ELECTRICAL POWER SUPPLY REQUIREMENTS

It is the owner's responsibility to ensure that the electrical connection of this appliance is performed by a qualified electrician. The electrical installation, including minimum supply wire size and grounding, must be in accordance with the National Electric code ANSI/NFPA 70-1993* (or latest revision) and local codes and ordinances.

*A copy of this standard may be obtained from:

**National Fire Protection Association
1 Batterymarch Park
Quincy, Massachusetts 02269-9101**

The correct voltage, frequency, and amperage must be supplied to the appliance from a separate, grounded, circuit that is protected by a properly sized circuit breaker or time delay fuse.

Refer to the Gas and Electrical Requirements Table.



WARNING

If the gas or electric service provided does not meet the product specifications, do not proceed with the installation. Call the selling dealer, the gas supplier, or a licensed electrician.

NOTES: The power supply must be properly polarized. Reverse polarity will result in continuous sparking of the electrodes, even after flame ignition.

If there is any doubt as to whether the power supply is properly polarized or grounded, have it checked by a qualified electrician.

GAS AND ELECTRICAL ROUGH-IN

Locations

NOTE: The shaded areas shown in the illustrations, denote the location of the gas stub and the electrical junction box/receptacle. These are suggested

locations. For replacement purposes, the location of the existing utilities may be utilized provided that they do not interfere with the sides or rear of the range. If installing the gas valve behind the range, verify that local building codes will permit this.

A manual shut valve must be installed in the gas piping, external to the appliance, for the purpose of turning on or shutting off gas to the appliance. Plan the location of the range and the gas supply to allow access to the valve when the unit is installed. Access to the remote circuit breaker panel/fuse box, with the range in place, must also be allowed for in the installation. Any openings in the wall behind the appliance and in the floor under the appliance must be sealed.

Both the gas supply piping and shut-off valve, and the electrical junction box/receptacle must be located so they do not interfere with the range when it is installed. In addition, the junction box must be located so the range can be removed for service when the conduit supplied with the unit is attached to the junction box. Do not lengthen the conduit or wiring provided with the range.

All dimensions shown are based on standard American cabinets 36 inches (914mm) high at the finished countertop by 24 inches (610mm) deep, with a 25 inch (635mm) overall countertop depth. When installing the range into nonstandard cabinets, minimum clearances shown in the diagrams on page 11 must be maintained.

Carefully check the location where the range is to be installed. For best performance, the range should be placed away from drafts that may be caused by doors, windows and HVAC outlets.

CABINET AND COUNTERTOP PREPARATION

NOTES:

- **If cabinet storage space is to be provided directly above the range, the risk of personal injury may be reduced by installing a ventilating hood that projects horizontally a minimum of 5 inches beyond the face of the cabinets.**
- **The range may be installed flush to the rear wall. We recommend installing a non-combustible material on the rear wall above the range and up to the vent hood. It is not necessary to install non-combustible materials behind the range below the countertop height.**

- The minimum distance from the sides of the range above the countertop to combustible side walls must be at least 10 inches.
- The E36DF76EPS and E48DF76EPS ranges are delivered with a 3” backguard from the factory. 9” and 24” backguards are available as options. The E30DF74EPS range is delivered with a 6” backguard from the factory. 9” and 12” backguards are available as options.
- Utilities may be located: In the lower left corner of the adjacent right cabinet. (Recommended)

IMPORTANT

- Contact your local building department to verify compliance with local code interpretation.

Plan the installation so that the electrical connection, gas shut-off valve, and pressure regulator are accessible from the front of the cabinet.

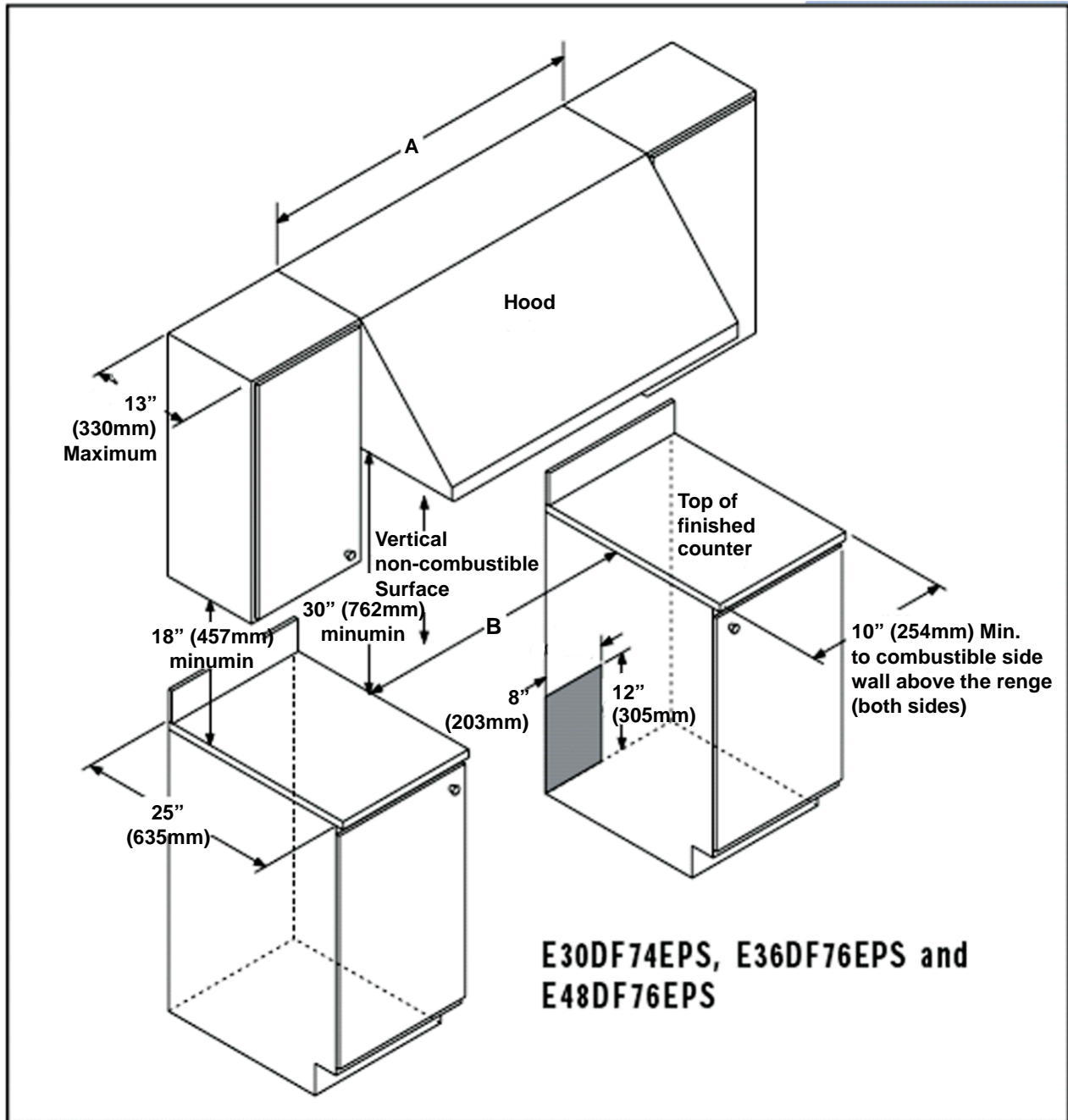

Cutout Dimensions		
Model	"A"	"B"
E30DF74EPS	36" (914mm) Recommended 30" (762mm) Minimum	30 1/16" (764mm)
E36DF76EPS	42" (1067mm) Recommended 36" (914mm) Minimum	36 1/16" (914mm)
E48DF76EPS	54" (1372mm) Recommended 48" (1219mm) Minimum	48 1/8" (1222mm)

E36DF76EPS and E48DF76EPS Overall Dimensions Side View

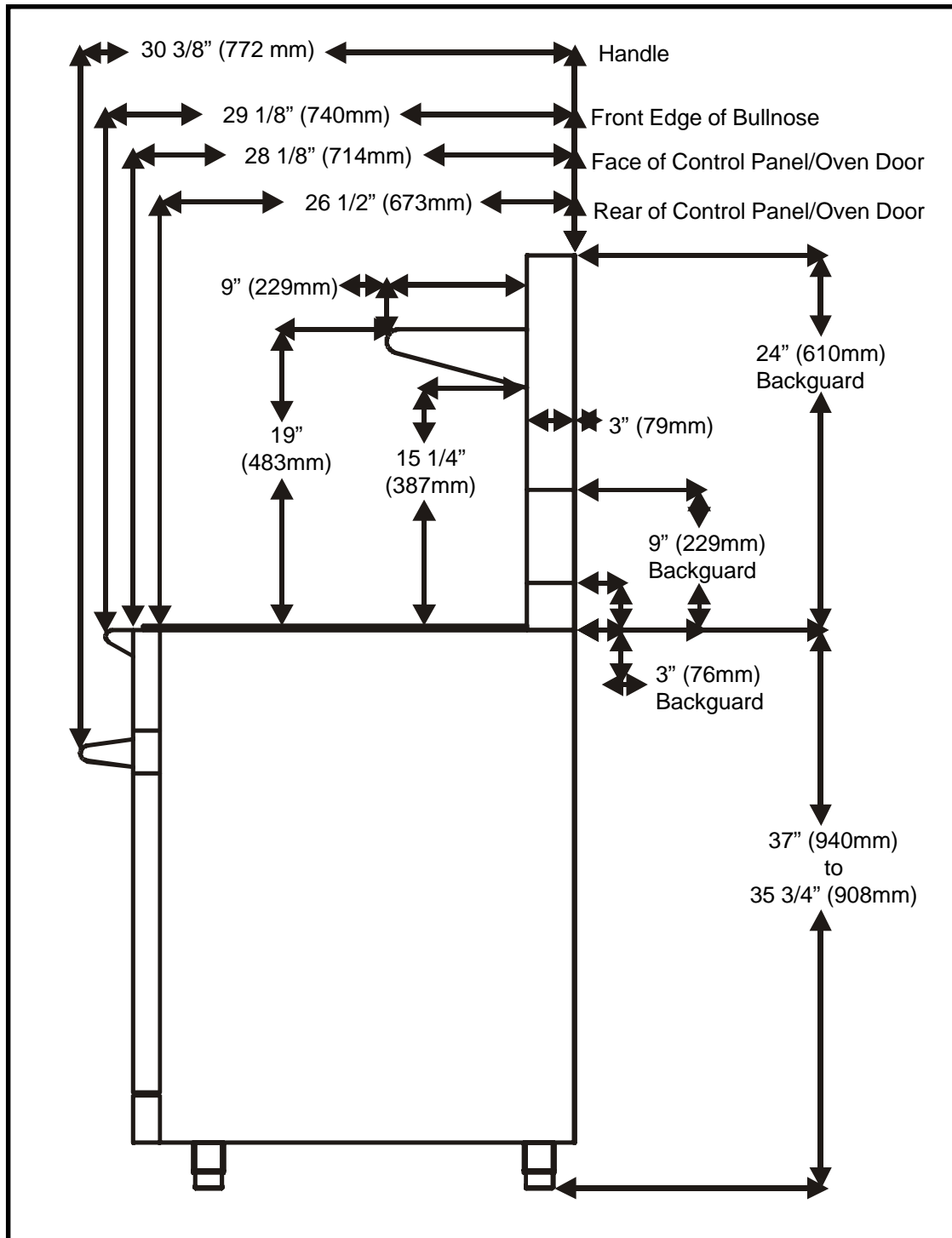

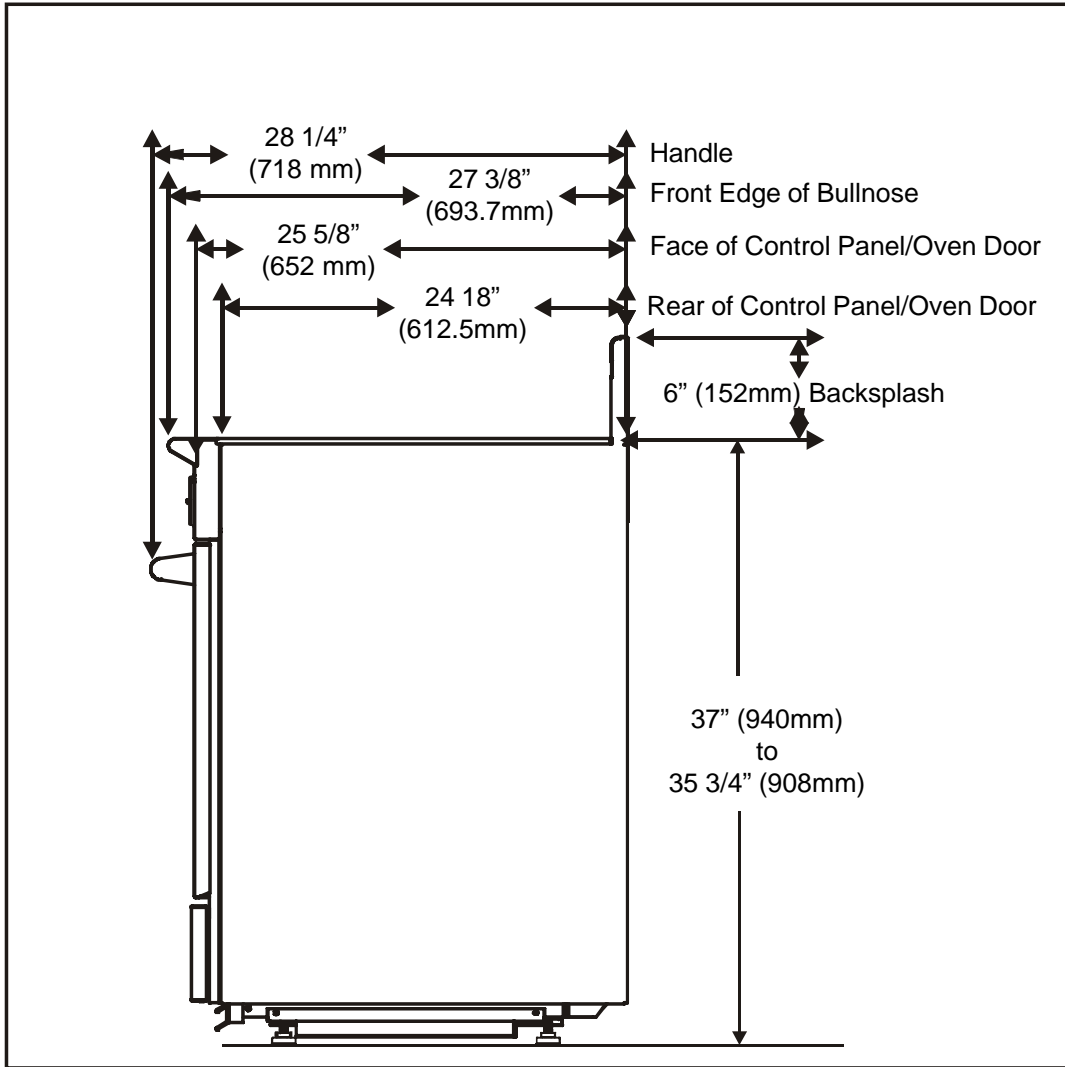

INSTALLING THE ANTI-TIP BRACKET (FOR 30", 36" & 48" MODELS)

WARNING

The 30", 36" and 48" ranges require an anti-tip device. Before installing the range, you must locate and secure the anti-tip bracket to the floor.

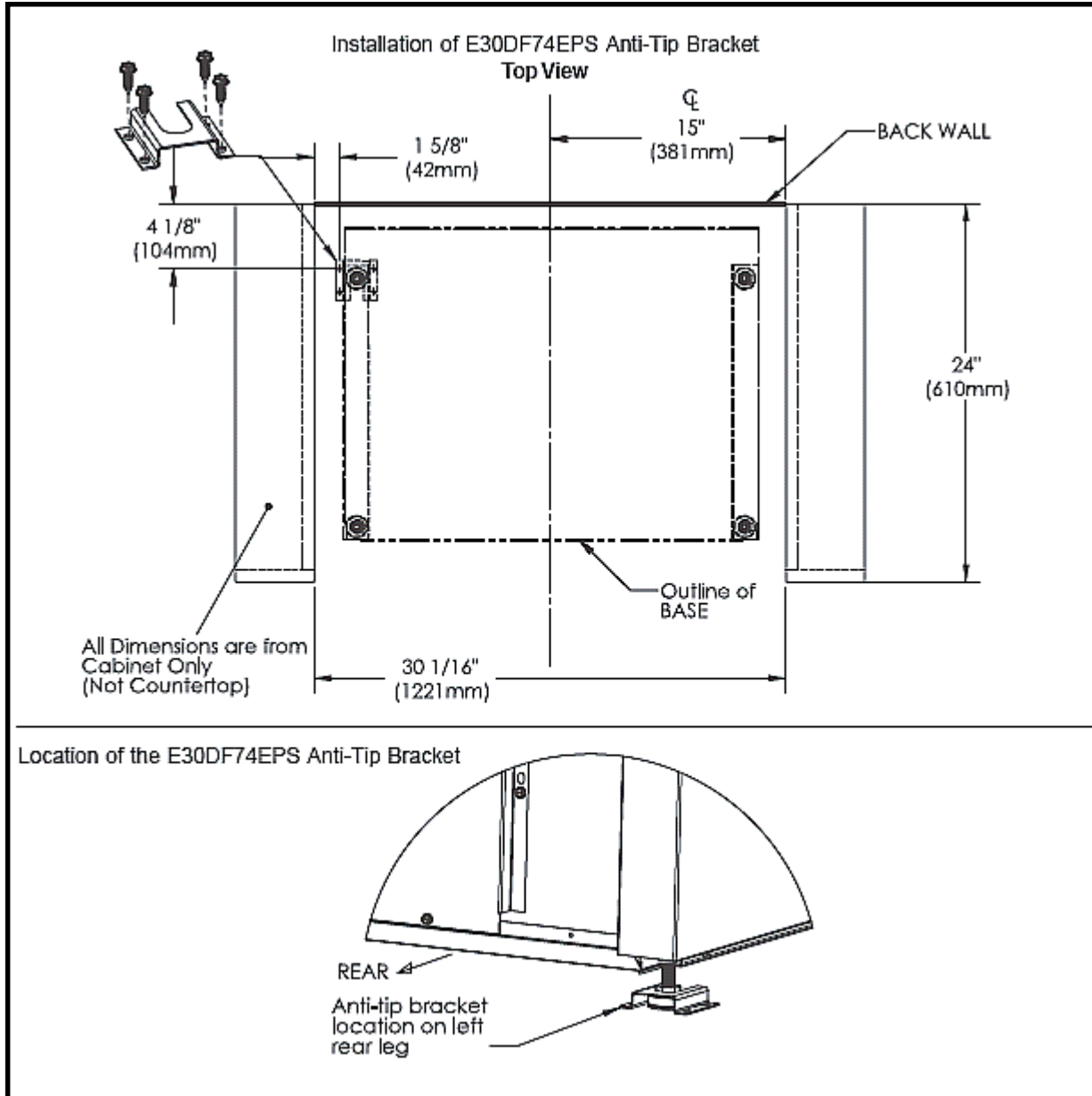

INSTALLING THE ANTI-TIP BRACKET (FOR 30", 36" & 48" MODELS)

WARNING

The 30", 36" and 48" ranges require an anti-tip device. Before installing the range, you must locate and secure the anti-tip bracket to the floor.

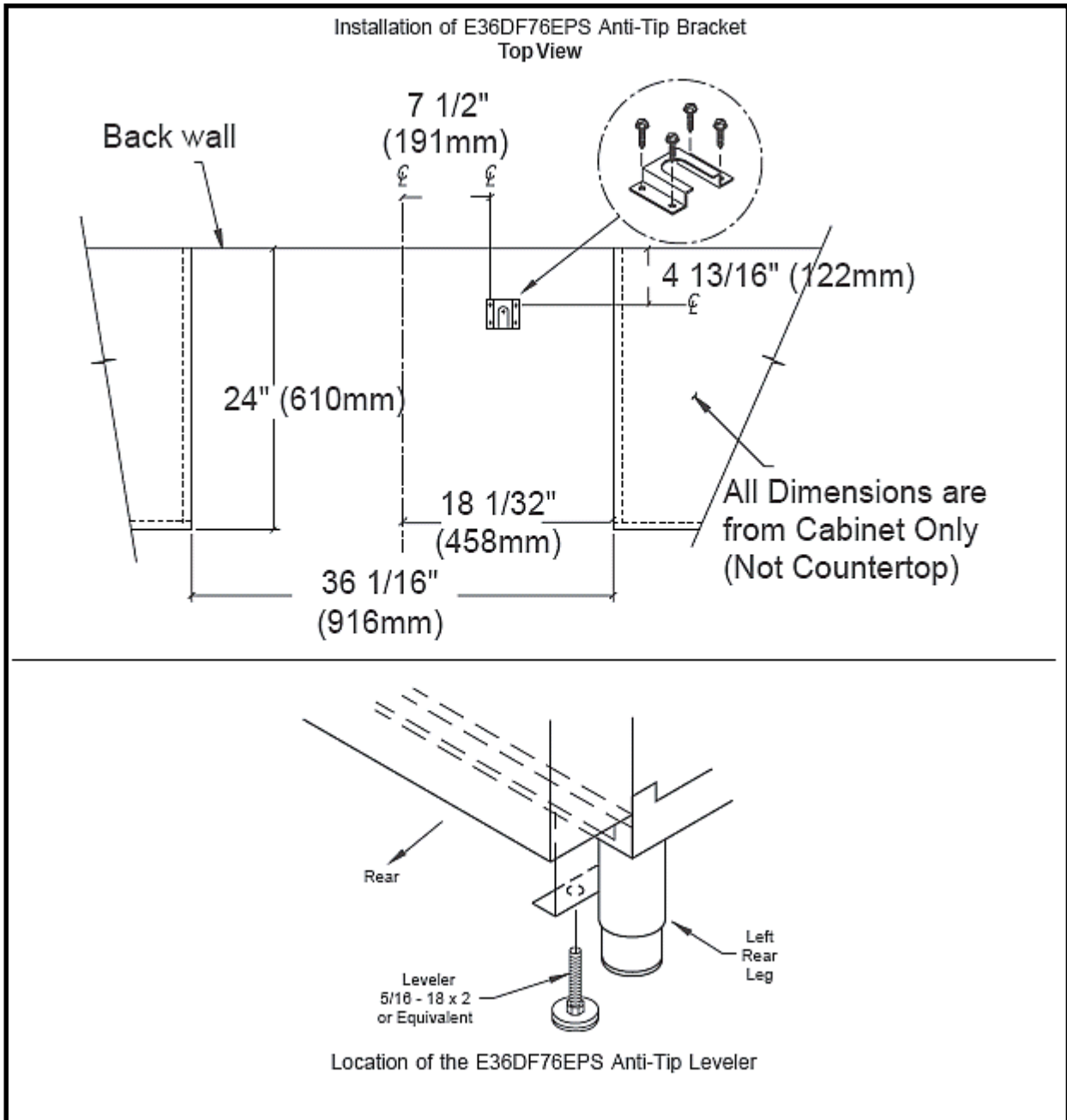

INSTALLING THE ANTI-TIP BRACKET (FOR 30", 36" & 48" MODELS)



WARNING

The 30", 36" and 48" ranges require an anti-tip device. Before installing the range, you must locate and secure the anti-tip bracket to the floor.

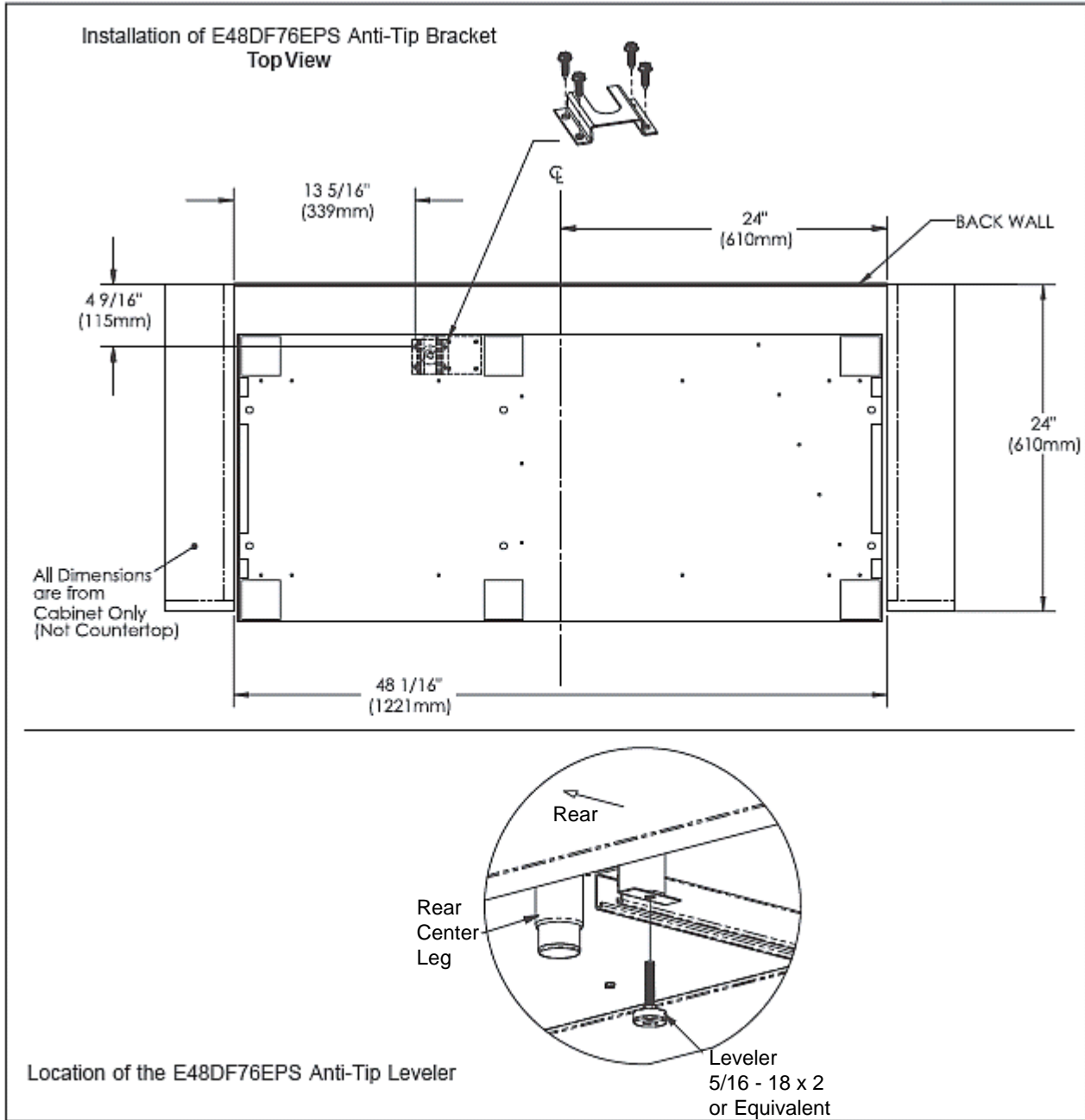

GAS REGULATOR AND ELECTRICAL CONDUIT LOCATION

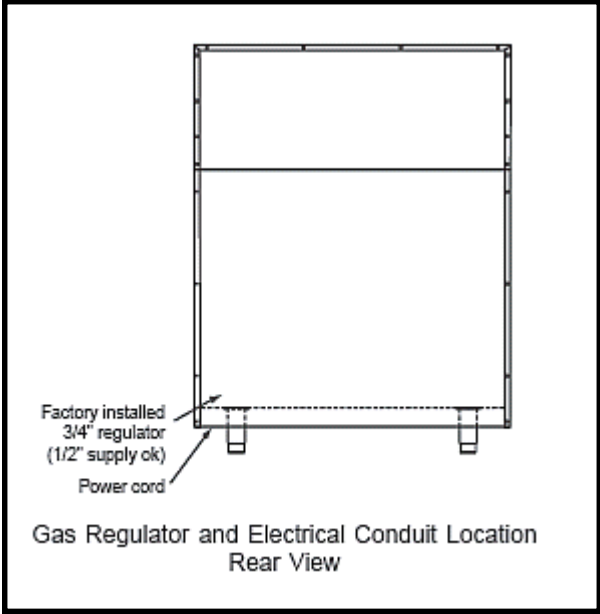

Installation

INSTALLING THE 30", 36" & 48" RANGE OPTIONAL BACKGUARDS

Your Electrolux Icon™ range was shipped with a backguard in place. These instructions cover the installation of one of the optional backguards.

WARNING

Be sure that the range is not connected to gas or power before proceeding.

Installing the Range Optional Backguard:

1. Remove the backguard from its box.

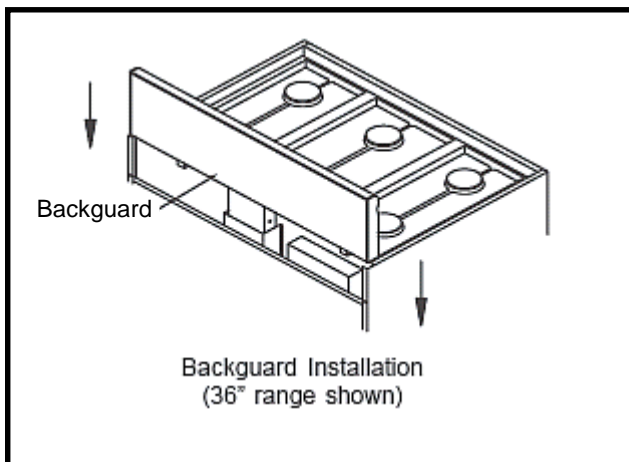

2. To avoid scratches, place small scraps of thin cardboard on the rear of the side panels where the backguard will make contact. With the assistance of at least one other person, carefully lift the backguard and place down on to the range top. Special attention should be given to the lower flange in front of the backguard, which must fit between the stainless steel side panels.
3. Fasten the provided screws through the rear flange.
4. Connect the gas line to the regulator. Reposition and attach the access panel or the back cover if the entire back cover was removed.
5. You are now ready to continue with the range installation.

NOTE: For 24" Backguards, fasten the provided screws through the holes in the back panel of the Backguard.

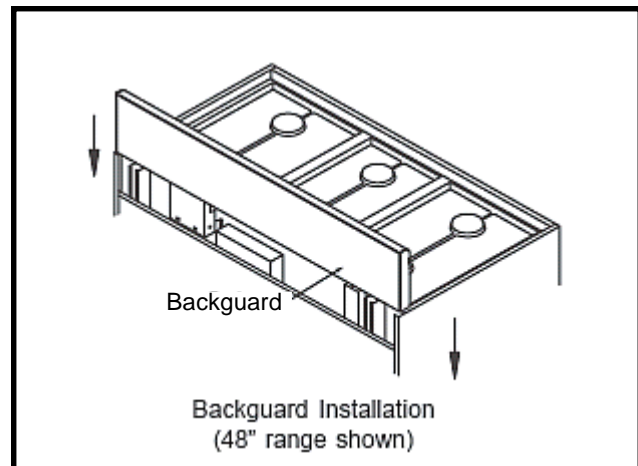

REMOVING THE OVEN DOOR(S)



WARNING

Do not attempt to disengage the hinge catches with the door removed from the oven. The hinge springs could release causing personal injury.

Do not lift or carry the oven door by the door handle.

Open the door to its fully opened position. Rotate the catch over the retaining arm on each hinge. Lift the oven door to about a 30 degree angle from the horizontal position. Pull the door away from the oven while continuing to lift.

RE-INSTALLING THE OVEN DOOR(S)

Grasp the oven door on opposite sides and lift it until the door hinges are aligned with the openings in the oven frame. Holding the door at about a 30° angle from the horizontal, slide the hinges into the openings until the bottom hinge arms drop fully into the hinge receptacles. Lower the door to the fully opened position, and then rotate the two hinge catches toward the oven.

Open and close the door completely to ensure that it is properly installed.

Peel off the protective layer of plastic that covers the door panel.

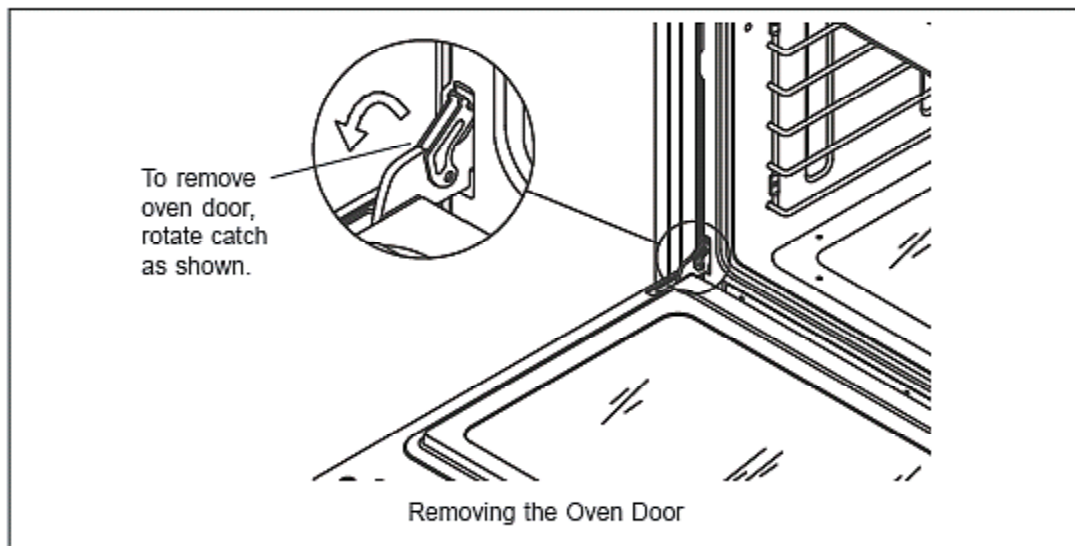

MAKING THE ELECTRICAL CONNECTION



WARNING

- Models E30DF74EPS, E36DF76EPS and E48DF76EPS must be connected to a grounded, metallic, permanent wiring system. Alternatively, a grounding conductor should be connected to the grounding terminal or lead on the appliance. Failure to do so may result in an electric shock hazard.
- Do not use an extension cord with this appliance. Such use may result in fire, electrical shock, or other personal injury.
- Do not install a fuse in the neutral or ground circuit. A fuse in the neutral or ground circuit may result in an electrical shock hazard.

Grounding Instructions

This appliance must be electrically grounded. With the range positioned directly in front of the cabinet cut-out, feed the appliance conduit to the electrical junction box. Then, depending upon local codes, utilize one of the following techniques to connect the appliance to the electrical power supply:

Connecting to a Four-Wire Electrical System

1. Separate the green and white appliance wires.
2. Connect the white appliance wire to the neutral (white) supply wire in the junction box.
3. Connect the black appliance wire to the black (L1) power supply wire in the junction box.
4. Connect the red appliance wire to the red (L2) power supply wire in the junction box.
5. Connect the green appliance wire to the green house grounding wire in the junction box.

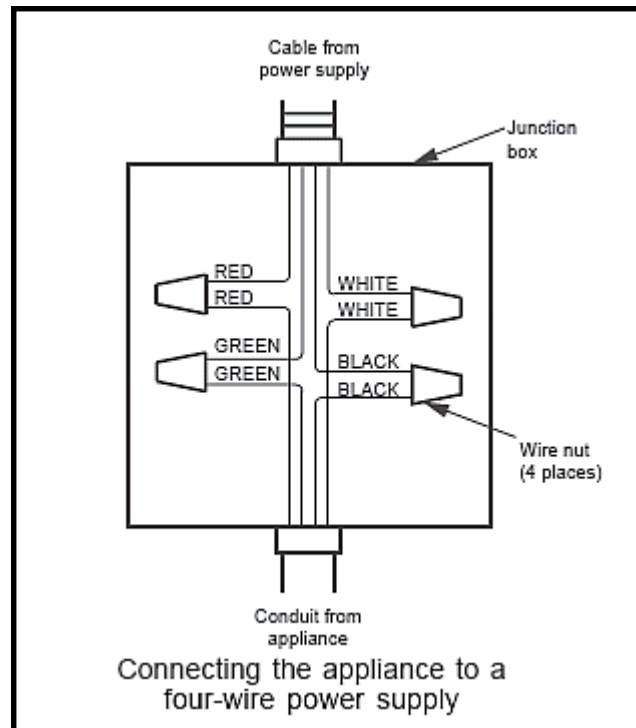

WARNING

Do not connect the green appliance wire to the neutral (white) supply wire unless local building codes permit.

Connecting the Green Appliance Wire to the Neutral (White) Supply Wire – Where Local Codes Permit

1. Connect the green and white appliance wires to the neutral (white) supply wire in the junction box.
2. Connect the black appliance wire to the black (L1) power supply wire in the junction box.

- 3 Connect the red appliance wire to the red (L2) power supply wire in the junction box.

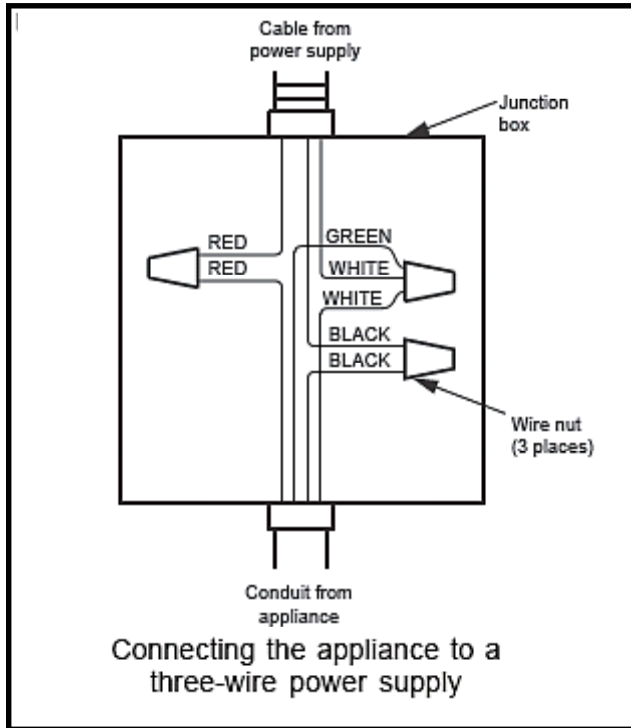

- 2 Connect the white appliance wire to the neutral (white) supply wire in the junction box.
- 3 Connect the black appliance wire to the black (L1) power supply wire in the junction box.
- 4 Connect the red appliance wire to the red (L2) power supply wire in the junction box.
- 5 Connect the green appliance wire to a grounded supply wire in the junction box or to a grounded cold water pipe.
- 6 If connecting to a grounded cold water pipe, a separate copper grounding wire (No. 10 minimum) must be connected to a grounded cold water pipe by means of a clamp and then to an external grounding connector screw.

WARNING

- Do not ground the appliance to a gas supply pipe or hot water pipe.
- Do not turn on power to the appliance until the range is permanently grounded.
- A grounded cold water pipe must have metal continuity to electrical ground and must not be interrupted by insulating materials. Any insulating materials must be jumped with a length of No. 4 copper wire securely clamped to bare metal at both ends.

Connecting the Green Appliance Wire to a Grounded Supply Wire or a Grounded Cold Water Pipe – Where Local Codes Permit.

- 1 Separate the green and white appliance wires.

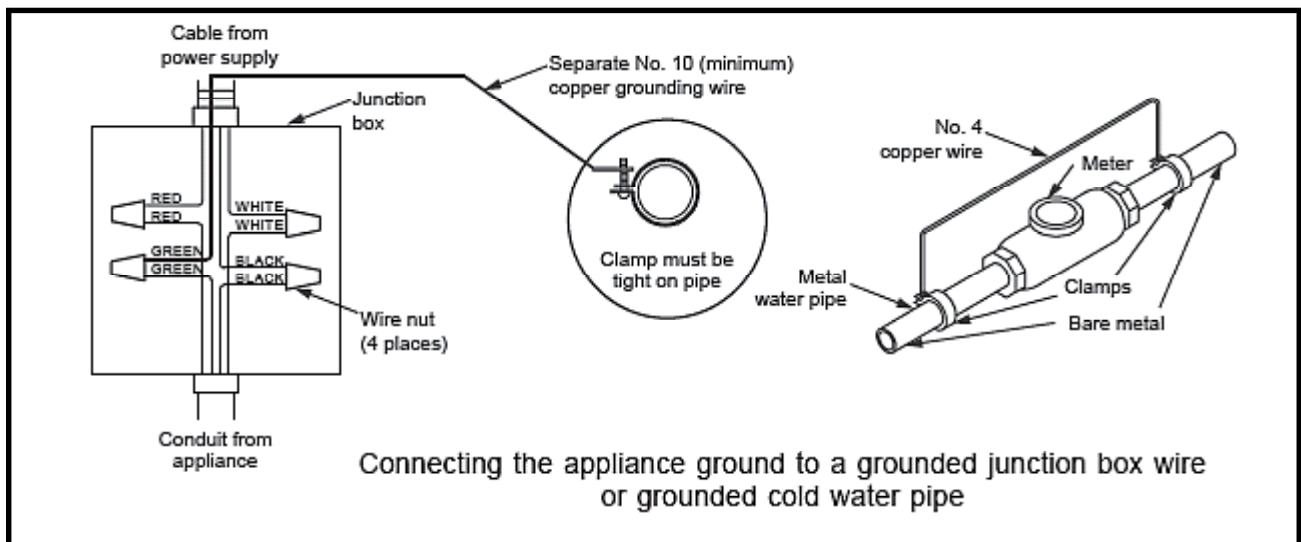

MAKING THE GAS CONNECTION

Before sliding the range into the cabinet, connect a flexible gas connector to the gas shut-off valve previously installed on the stub out. The gas valve must be turned off during installation. Connect the flex connector to the pipe fitting at the right rear of the range.

WARNING

- Do not apply excessive pressure when tightening gas connections and fittings.
- Do not use teflon tape or plumber's putty on gas flex line connections.
- Turn all cooktop control valves to the "OFF" position. Turn on gas supply and check all lines and connections for leaks using a soap and water solution. Do not use a flame to check for leaks. After verifying that there are no gas leaks, turn off the gas supply to the range by turning the gas shut-off valve to the "OFF" position.
- For LP installations, the LP gas tank must have its own high pressure regulator. This is in addition to the pressure regulator provided with the range.
- The maximum gas supply pressure to the regulator must never exceed 1/2 pound per square inch.

NOTE: The gas pressure regulator is pre-set at the factory for natural gas to use with the appliance. To convert the range for LP gas, see the instructions supplied in the LP conversion package.

INSTALLING THE RANGE

Measure from the floor to the countertop and adjust the leveling legs as required to position the top frame at the desired height, based on the cabinet and countertop installation. Carefully slide the range into position in the cutout. The rear anti-tip leg should engage the anti-tip bracket.

INSTALLING THE BURNER COMPONENTS

Remove the brass burner rings, porcelain burner caps, and porcelain gates from their shipping packages. Place each burner ring onto its corresponding burner base, being certain that the four alignment tabs slide into the matching notches in the base. Set each porcelain burner cap on top of its corresponding burner ring. Place each

grate onto the top frame, being certain that the rubber feet are positioned in the locating dimples.

WARNING

Never attempt to operate the cooktop section of the range with any of the burner rings, burner caps or grates removed.

NOTE: Prior to operating the cooktop or oven sections of the range, please read the accompanying Use and Care Manual carefully. Important safety, service and warranty information is contained within this manual.

Operation

VERIFYING THE OPERATION

NOTE: REFER TO THE USE AND CARE MANUAL FOR DETAILED INSTRUCTIONS.

Before beginning the test procedure, ensure that all cooktop control valves are in the “OFF” position, and all burner rings, burner caps, and grates are properly positioned on the top frame. Turn on the gas supply at the shut-off valve.

Turn on the power supply to the range. Select a temperature of 350°F by rotating the temperature control knob to “350” and selecting “BAKE” with the oven selector knob. Rotate each knob to the “Off” position to stop the heating process. For model E48DF76EPS, repeat this test procedure with the companion oven. Test each top burner separately by pressing and turning one control knob at a time counterclockwise to the “HIGH” position. All ignitors will spark continuously, but only the burner with gas flowing to it will ignite. (It will take approximately 4 seconds for ignition to occur, at which time the ignitors will stop sparking. If ignition does not occur within 4 seconds, turn off the knob, wait for at least 2 minutes to allow any gas to dissipate, then repeat this ignition test.) The control knob can then be rotated counterclockwise from “HIGH” to “LOW” to adjust the flame height progressively. Repeat the ignition test for all burners. When installed properly, the flame will be steady and quiet. It will also have a sharp, blue inner cone that will vary in length proportional to the burner size.



WARNING

- **The range and shut-off valve must be disconnected from the gas supply piping during any pressure testing exceeding 1/2 psi (3.5kPa).**
- **The range must be isolated from the gas supply piping by closing the shut-off valve during any pressure testing at or below 1/2 psi (3.5 kPa).**

NOTES If either the oven or cooktop does not operate properly, follow these troubleshooting steps:

- **Verify that power and gas are supplied to the range.**
- **Check the electrical connections and gas supply to ensure that the installation has been completed correctly.**

- **If the appliance still does not work, contact an authorized service company. Do not attempt to repair the appliance yourself.**

Electrolux is not responsible for service required to correct a faulty installation.

SECTION C - THEORY OF OPERATION

Gas flow

The incoming gas flow is connected to a pressure regulator, which is mounted to the rear of the range.

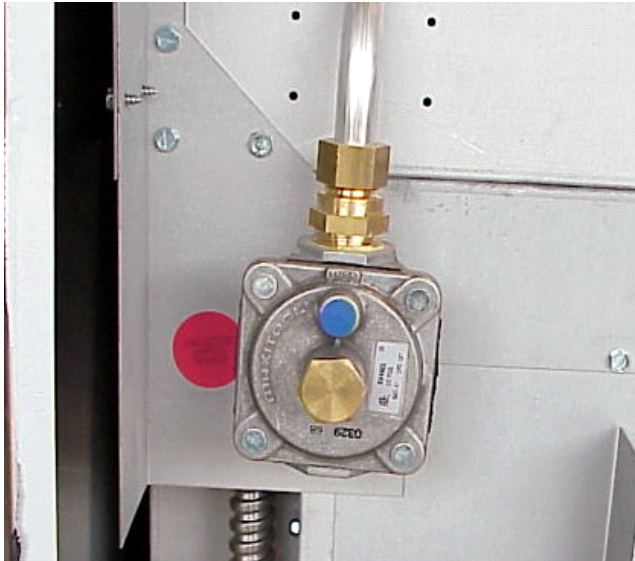

A pressure regulator is a device that maintains a constant fixed output pressure, by increasing or decreasing the gas flow in the range to match the output of the burners. The pressure regulator on the range is a convertible regulator that can be set for an output pressure of either 4 or 11 inches of water column pressure. This allows a range to be installed on either natural or LP gas. When the range is shipped from the factory the range is set up to operate on natural gas. The output of the regulator is set for 4 inches of water column pressure. If the range is installed on LP gas it is necessary to install the conversion kit that is ship with the range. Once the range has been converted the output pressure of the pressure regulator will be 11 inches of water column pressure.

The conversion kit is shipped in a plastic bag in the broiler pan. The kit contains the installation instructions, burner orifices, bypass orifices and the burner removal tool.

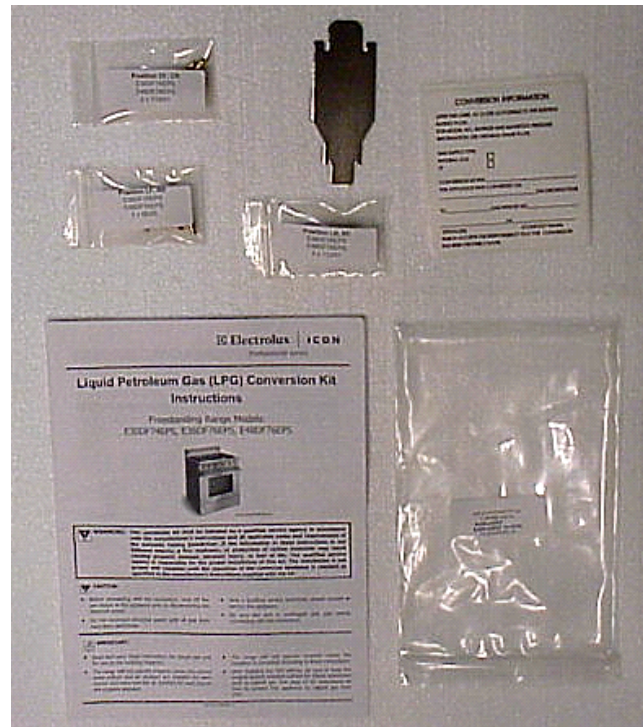

The pressure regulator is connected to the manifold pipe by a half-inch aluminum tube.

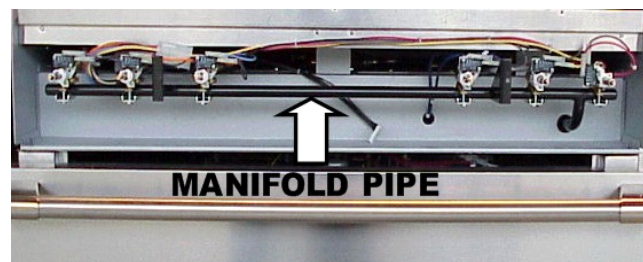

The manifold pipe is used to distribute gas to the top burner valves.

The top burner valves are mounted to the manifold pipe and control gas flow to the orifice assembly.

The top burner valves are mounted to the manifold pipe and controls gas flow to the orifice assembly.

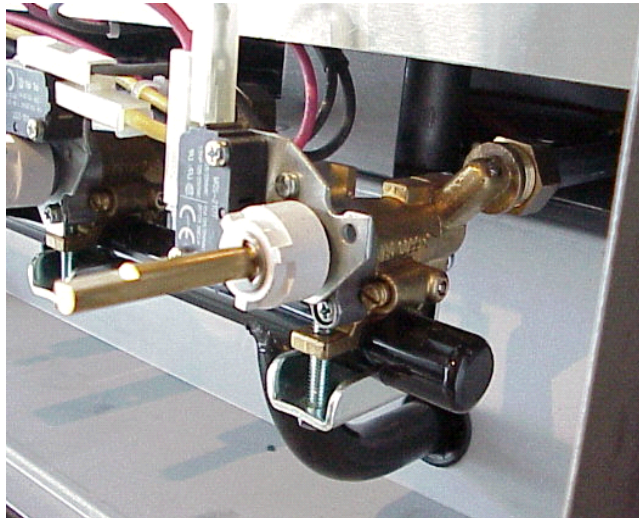

flowing through that section of the valve. In the low position the gas flow through the valve is through the bypass orifice, located on the side of the valve.

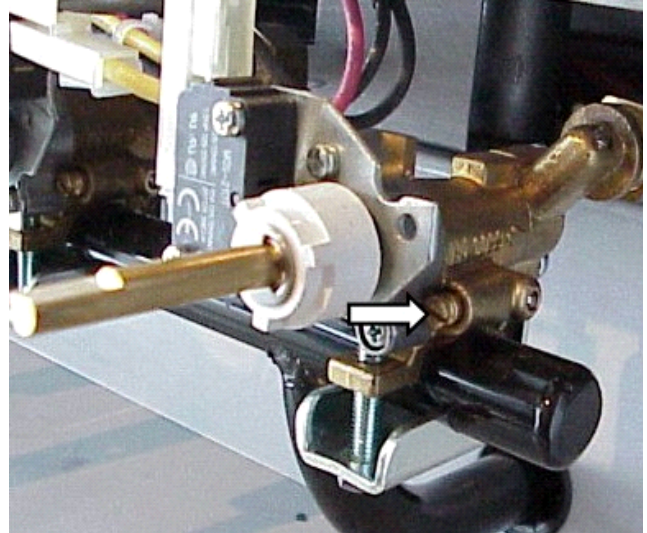

The valve is mounted to the manifold pipe so that the hole in the bottom of the valve is aligned with the hole of the manifold. This allows gas to enter into the valve. When the valve is in the off position the hollow core, in the center of the valve, prevents gas from flowing through the valve.

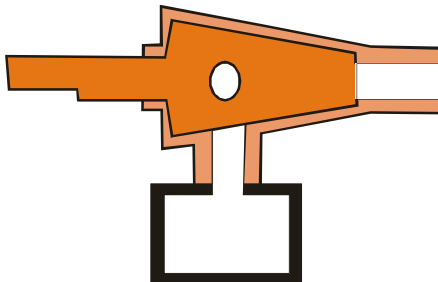

The output of the valve is connected to the orifice assembly by an aluminum tube.

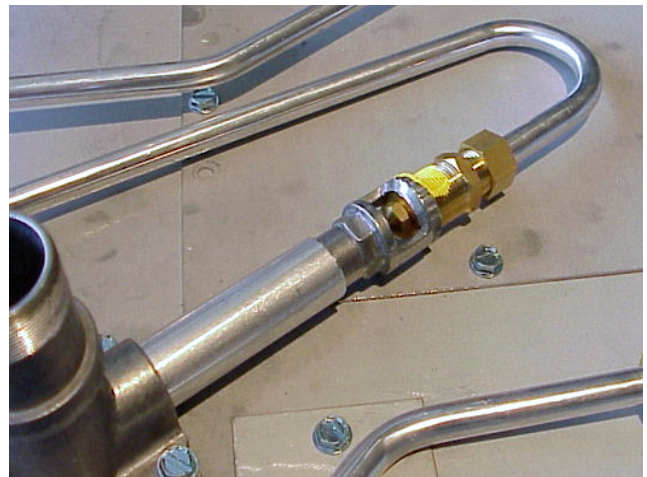

When the shaft of the valve is turned the hole in the side of the core moves over the hole in the case of the valve. When the shaft is turned to the high position the two holes are completely aligned and the maximum amount of gas is allowed to flow through the valve.

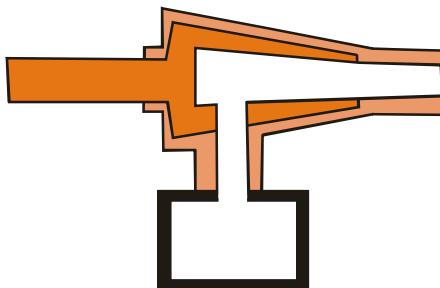

The orifice, or hole in the spud, serves two purposes; first it controls the maximum amount of gas to the burner and second it speeds up the gas flow as it enters the burner venturi.

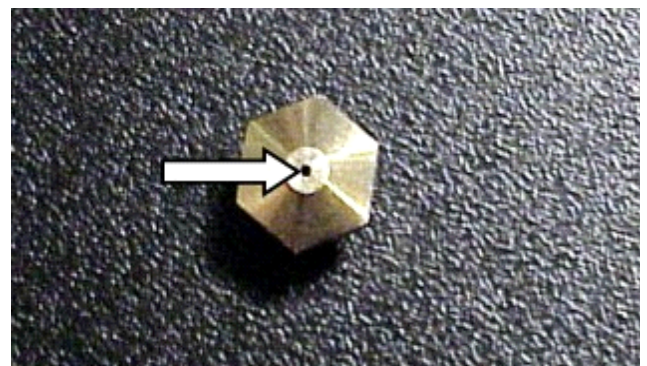

As the shaft is rotated off a high position the holes are misaligned and gas flow is reduced. When the shaft is turned completely to the low position the two holes are completely misaligned and gas is prevented from

When the gas leaves the orifice it passes through the air shutter. The moment of the gas through the air shutter creates a vacuum, which draws air into the burner venturi, where the air and gas mix. For proper combustion the ratio of this mixture should be ten parts of air to one part of gas.

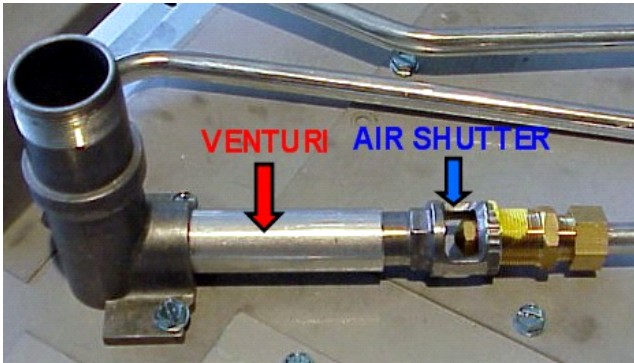

The mixture leaves the venturi and enters into the burner tube. The burner tube extends through the spill tray where the burner base is placed over it and a brass ring is tightened down on it, holding the burner base in place.



The burner ring is placed in the burner base. The slots in the burner ring, when closed at the top by the burner cap, forming the burner ports.

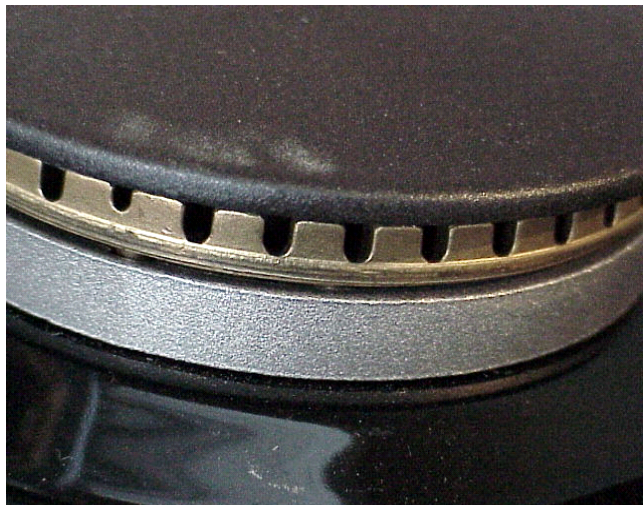
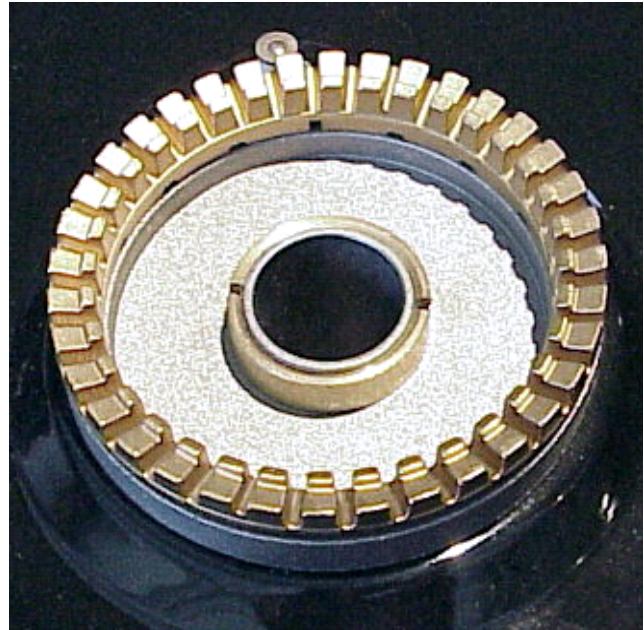

The combustible mixture which comes up the burner tube actually pressurizes the burner head, forcing the mixture out of the burner ports. When the mixture is ignited a sharp blue cones burns off the ports of the burner head.

Top burner ignition and reignition system

The burner ignition and reignition system is made up of the ignition switches, that are mounted to the top burner valves,

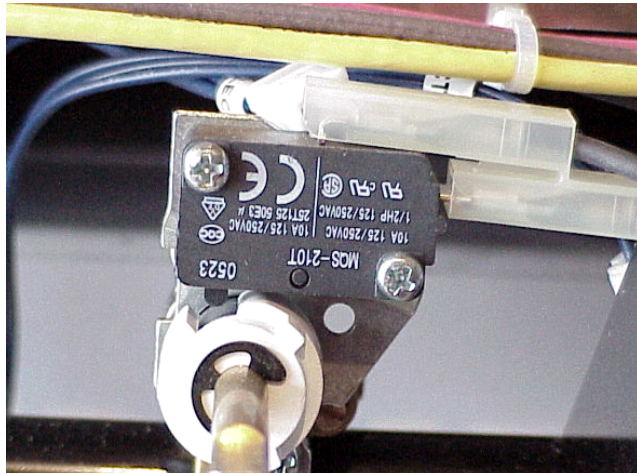

gas igniter/re-igniter module



and an igniter mounted to each burner base.

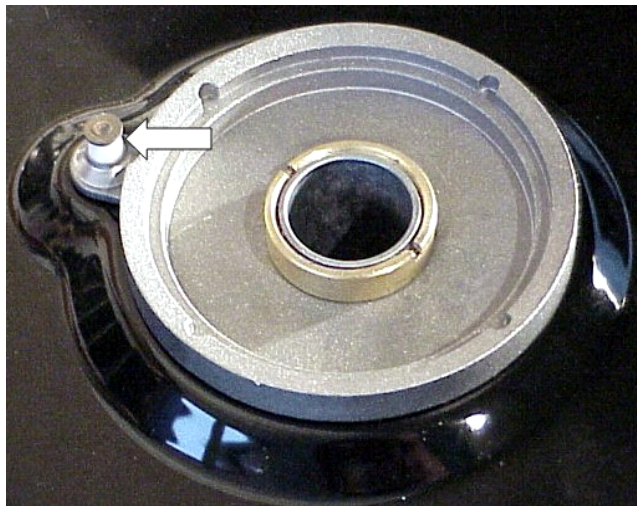

When the shaft of the valve is rotated from the off position the contacts of the igniter switch close and remain closed as long as the burner is on. This connects L1 to the module terminal for that burner. The module has two jobs; first to ignite the burner and once the burner has been ignited, to monitor the flame. When power is applied to the module, inside the module two things happened. First power is supplied to the step-up transformer, which in turn supplies power to the charging circuit and second an electrical signal is generated and applied to the igniter of the burner that is being ignited. The output of the charging circuit is applied to all the igniters. The following explanation is how a simple ignition system works. When L1 is applied to the primary of the step-up transformer T1, the output voltage on the secondary side of transformer is increased. Since AC voltage is being applied to the transformer the ends of the transformer will change polarity every half cycle. In the drawing below, when the polarity of the transformer secondary winding is negative at the top and positive at the bottom, current flows in the circuit formed by the transformer secondary, diode D1, capacitor C1 and resistor R1. This charges C1 negative on the top and positive on the bottom. On the next half cycle, when the top of the transformer secondary winding is positive and the bottom is negative, the diode prevents current flow in the circuit and prevents the capacitor from discharging. At this point the capacitor also is prevented from discharging through the circuit formed by the capacitor, Ib1 (igniter bank one), the range chassis, Ib2 (igniter bank 2) and R1 by the dielectric of the air between the igniter's and the burner heads. In this drawing the burner heads are considered part of the range chassis. The capacitor continues to charge every half cycle until the charge on the capacitor is high enough to break down the resistance of the air dielectric between the igniter tips and burner heads. At that time an electric spark occurs between all of the igniter tips and the burner heads. This allows current flow from the top of the capacitor to the Ib1, across the electrical arc into the range chassis and from the range chassis across the electrical arc into Ib2, through the resistor to the other side of the capacitor discharging the capacitor.

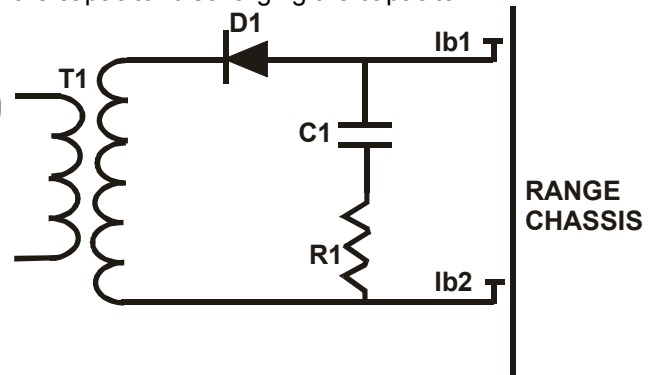

This cycle continues until the burner is ignited. The symbols Ib1 and Ib2 represents one half of the total top

burner igniter's each. If the range has six top burners lb1 would represent three igniters and lb2 would represent three igniters. The resistor R1 is placed in the circuit to slow down the charging time and control the number of sparks per second.

Once the burner has been ignited the module monitors the flames present by sending a small electrical signal to the igniter for that burner. A gas flame will conduct an electrical current. The electrical signal, sent by the module to the igniter, passes through the gas flame to the burner head. From the burner head the signal passes into the range chassis and returns to the module through the ground terminal on the module. This tells the module that flame is present on the burner. If for any reason the flame goes out, the circuit is interrupted. This tells the module to power the charging circuit and reignite the burner.

Oven Operation

The oven system is made up of; the electronic oven control board mounted between the burner box and the top of the oven,

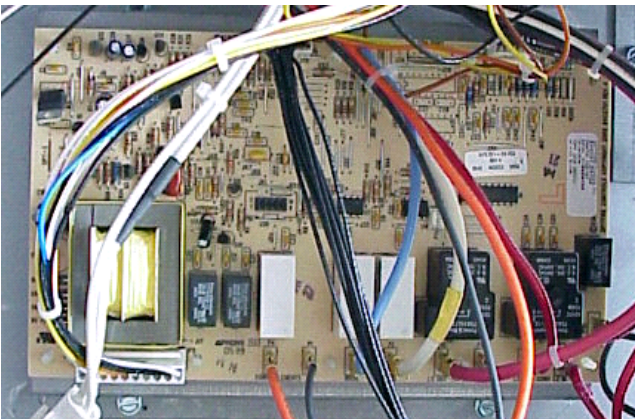

temperature selector mounted to the console,

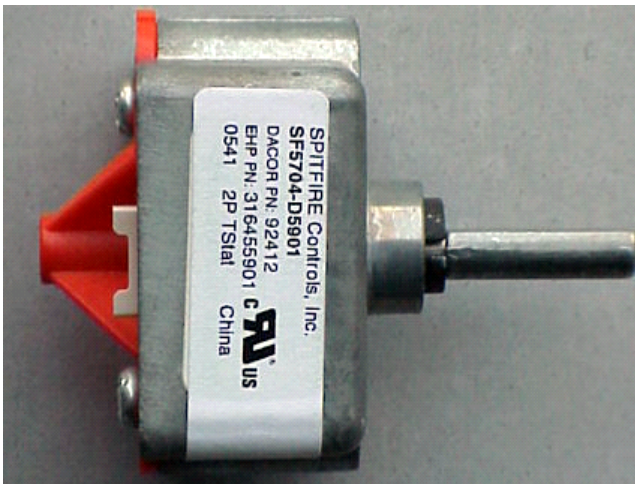

a function selector mounted to the console,

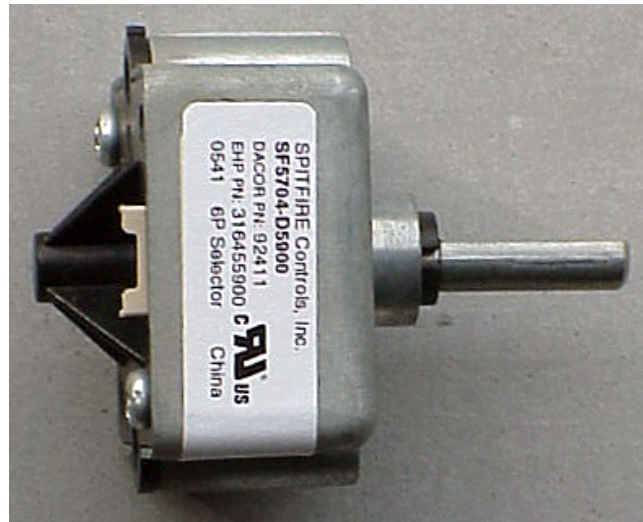

an interface board mounted to the console,

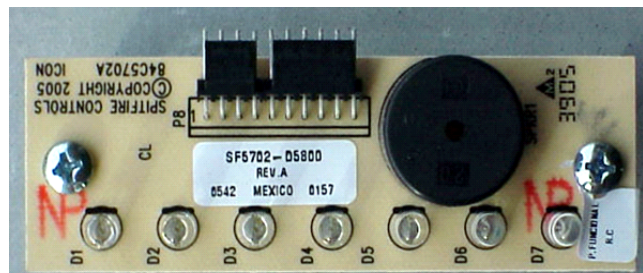

an oven sensor mounted to the rear wall of the oven,

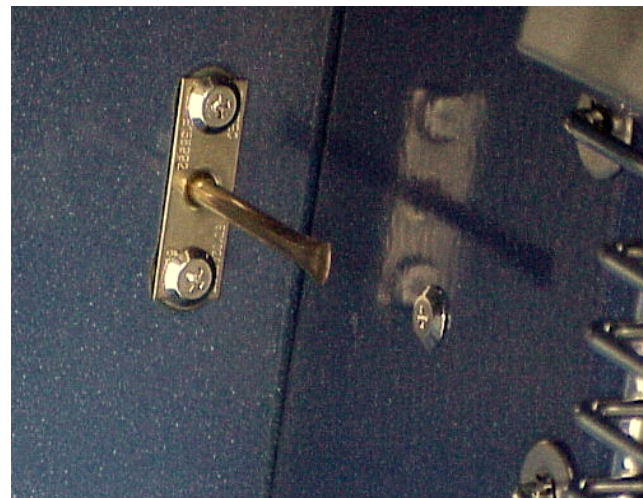

bake element mounted to the rear wall of the oven,



convection fan motor mounted to the rear of the oven,

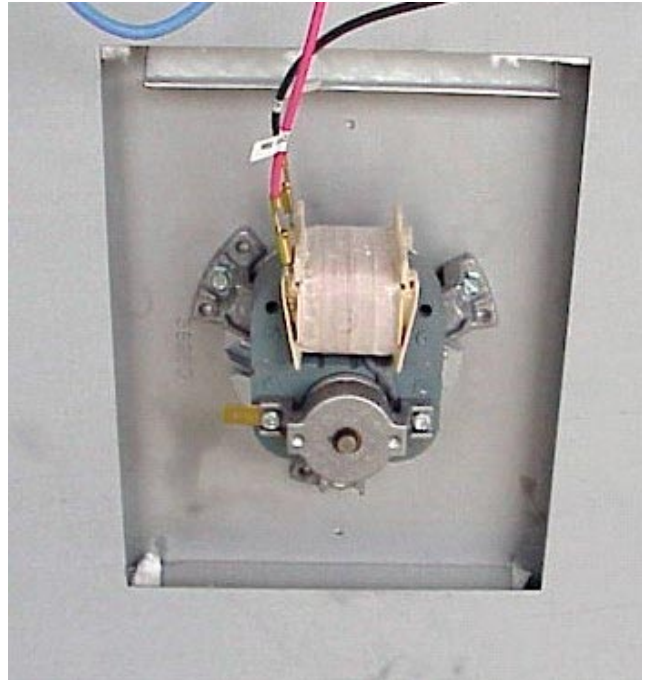

broil element mounted to the top of the oven,



oven high temp limit mounted between the burner box and the top of the oven,



convection element and fan blade mounted to the rear wall of the oven,



automatic door locking mechanism mounted between the burner box and the top of the oven,

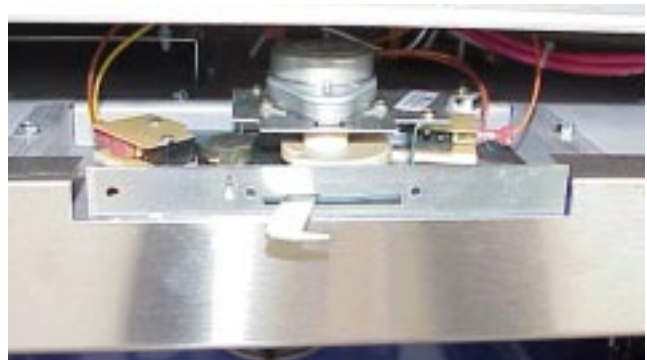

remove rack switch mounted on the rear of the oven,

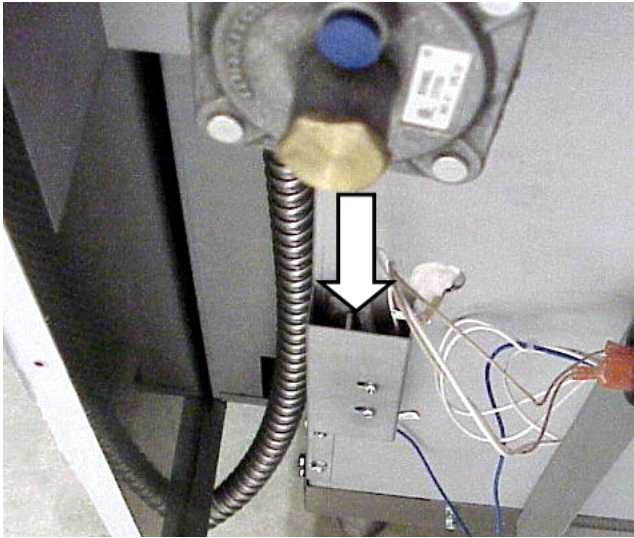

and the cooling blower mounted between the burner box and the oven at the rear of the range.

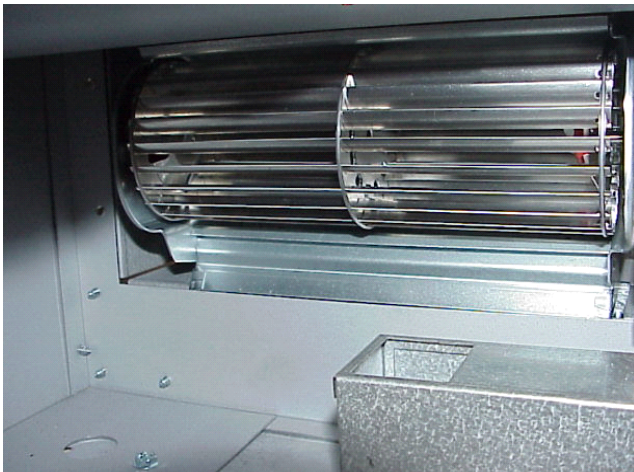

When electrical power is applied to the range line 1 is connected directly to the electronic oven control board and line 2 is connected to the electronic oven control board through the oven hi temp limit. The high temp limit is a manual resettable bimetal fuse that opens at 250°F that protect the range in case the oven overheats.

The electronic oven control, controls the operation of the oven. It receives input from the thermostat, selector, remove rack sw. and the oven sensor. The thermostat and selector are potentiometers. The control board applies an electrical potential across pins(1) and (3). The control then reads the voltage drops across pins (1) and (3) and pins (2) and (3). By reading the total voltage drop across the potentiometers and the voltage

dropped from the tap, and comparing the two, the control makes up for any variances in the control's resistance.

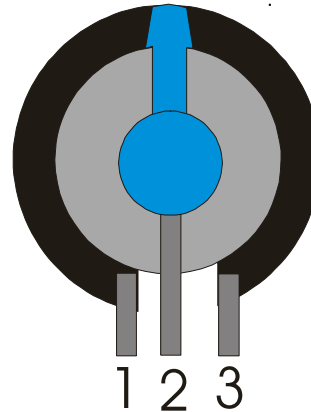

As the thermostat knob is turned the output from pin (2) changes telling the control what temperature is set. The selector operates in the same manner except there are indents for each function.

The oven temperature sensor operates by changing resistance also, the resistance of the sensor increases as the temperature in the oven rises. The control board reads the resistance of the oven sensor and compares it with the input from the thermostat. This allows the control board to cycle the elements in the oven to maintain the setting of the thermostat.

The control board supplies 240 VAC to the bake element, broil element, convection element and convection fan motor. 120 VAC to the lock motor and cooling blower. The control board also supplies an output to the interface board telling it which LED to light up.

Air movement in the oven during Convection Bake and Convection Roast.

When the oven is set for convection bake, the convection fan blade forces air across the convection element, which heats the air. The heated air is forced through

the convection filter into the oven. The air circulates through the oven and is drawn back to the fan blade through the holes in the side of the fan shield.

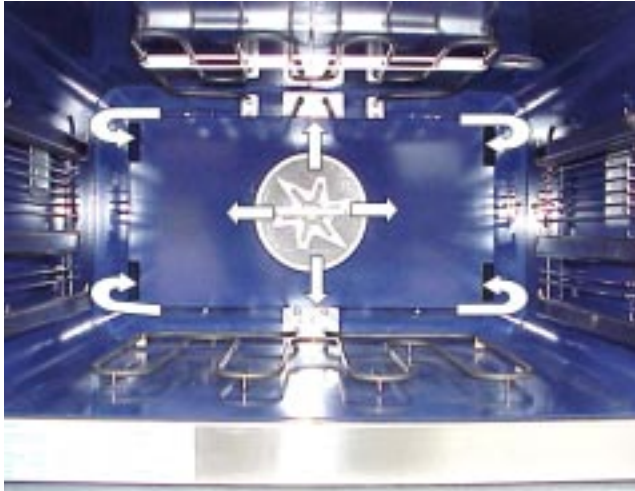

When the door is closed, the grill in the door matches the grill between the oven and the burner box. Air is drawn through this grill,

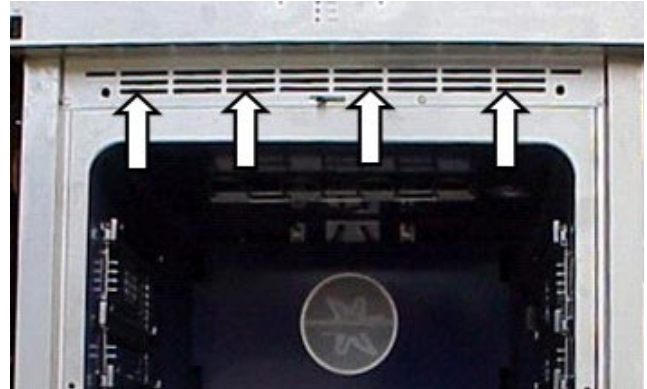

Note: During convection bake the electronic control automatically lowers the temperature 25° below the temperature set on the dial and only the convection element is used.

Note: During convection roast the bake element, broil element and the convection element are all used.

Cooling Blower air movement

The cooling blower is used to cool the oven door in the controls mounted between the oven and the burner box. Air is drawn in the bottom of the oven door,



through the oven door and out the grill work on the inside top of the door.



across the electronic control board, to the cooling fan blade.

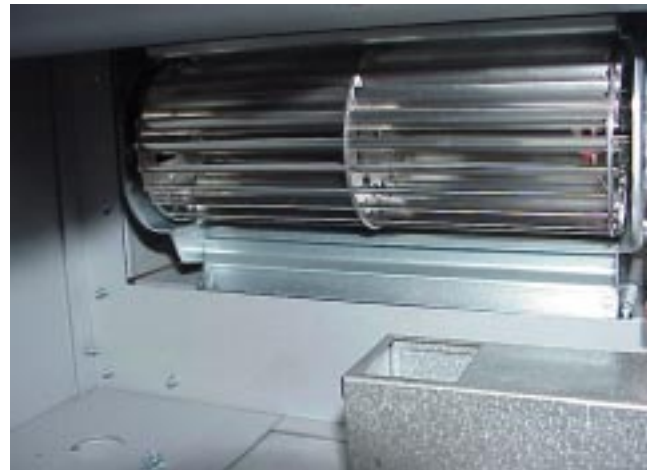

The air is then exhausted down a channel mounted to the rear of the oven to the floor underneath the range.

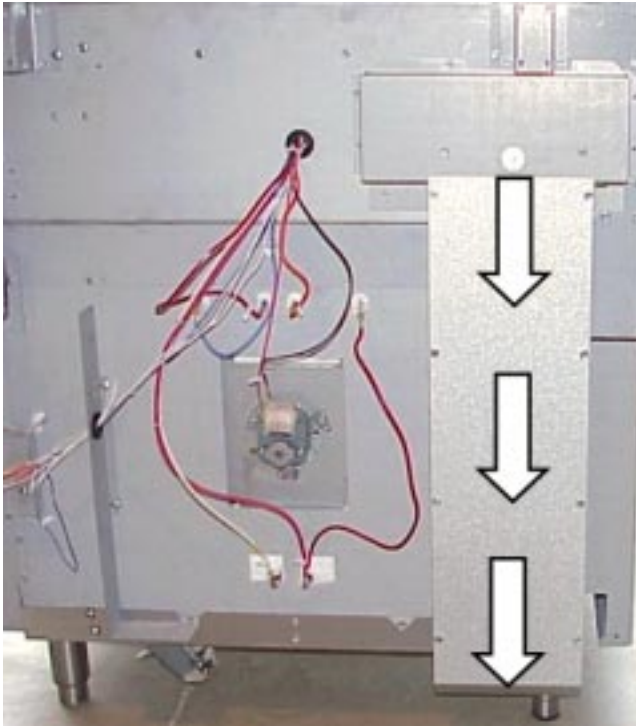

the door is locked and to go on with the clean cycle.

With the oven door locked, electronic oven control provides line to line voltage to the bake element until the temperature in the oven reaches 850°F. The electronic control then cycles the bake element to maintain this temperature, for the rest of the three-hour cycle. At the end of three hours, the electronic control removes power from the bake element and the oven starts to cool down. When the temperature in the oven drops below 490°, the electronic oven control board, applies power to the lock motor to unlock the door.

The self-cleaning cycle.

When the oven is set to self-cleaning cycle the electronic oven control board checks the rack removal switch. If the contacts of the switch are closed between common and normally open, telling the control board that the racks have been removed, the control board starts a self-cleaning cycle. To start the self-cleaning cycle the control board supplies line to neutral voltage to the motor of the door lock mechanism. The door lock mechanism is made up of a motor, a latch and two switches, the phase switch and the lock switch. The lock switch is controlled by the latch and the phase switch is controlled by a cam on the motor shaft. As the motor shaft turns, the latch is force to the right locking the oven door and closing the contacts of the lock switch. As the latch move to the right it hits the side of the slot in the door stopping the latch movement. If the latch does not hit the door, the locks switch will not close. This is how the latch mechanism proves that the doors closed and locked, before going into self-clean.

When the rotation of the motor shaft reaches one half turn the cam closes the contacts of the phase switch. Closing the contacts of the phase switch tells the control board to remove power from the motor. Closing the contacts of the lock switch tells the control board that

SECTION D -TROUBLEINGSHOOTING

NOTE: Always check the wiring and pin/plug connectors before replacing any component.

Index

Electrical components will not operate. _____	80
Flame too large and yellow on top burner. _____	80
Flame too small on top burner. _____	80
Flame goes out, when valve is turned to the low position. _____	80
Top burners, not burning properly. _____	80
One top burner, not burning properly. _____	81
Top burner valve difficult to turn. _____	81
Igniters do not spark when the burner knob is turned to the lite position. _____	81
Igniters spark but burner does not ignite. _____	81
Igniters continue to spark after burner is ignited. _____	81
Oven does not operate in any fuction. _____	82
Oven temperature off more than 10°. _____	83
Oven does not operate in bake. _____	83
Oven does not operate in broil. _____	84
Oven does not heat in convection bake and convection fan does not run. _____	84
Oven heats in convection bake but convection fan does not operate. _____	84
Oven does not heat in convection bake but the convection fan runs. _____	85
Oven does not heat in convection roast and convection fan does not run. _____	85
Oven does not heat in convection roast but convection fan runs. _____	86
Oven heats in convection roast but convection fan does not operate. _____	86
LEDs do not light. _____	86
One LED does not light. _____	86
Cooling fan does not operate. _____	86
Oven does not operate in self-cleaning. _____	87
One oven light does not light. _____	87
Both oven lights do not light. _____	87

FAILURE	CHECK	CORRECTION
Electrical components will not operate.	<ol style="list-style-type: none"> <li data-bbox="508 205 889 233">1. Check fuse or circuit breaker. <li data-bbox="508 331 927 422">2. Check line to neutral and line to line voltage, at the range terminal block. 	<p data-bbox="959 205 1430 264">If defective replace the fuse or reset the circuit breaker. If good go to step 2</p> <p data-bbox="959 331 1430 422">If the voltage readings are correct, there's a wiring problem in the range, check the range wiring.</p> <p data-bbox="959 464 1430 548">If the voltage readings are incorrect, defective house wiring or defective range cable.</p>
Flame too large and yellow on top burner.	<ol style="list-style-type: none"> <li data-bbox="508 653 927 711">1. Has the range being installed on LP gas without being converted? <li data-bbox="508 779 927 995">2. Check gas pressure at the top burners under flow. The pressure reading should be 10 inches of water column pressure for LP gas and 4 inches of water column pressure for natural. Is the pressure reading correct? 	<p data-bbox="959 653 1430 680">Yes, install LP conversion kit.</p> <p data-bbox="959 716 1000 743">No,</p> <p data-bbox="959 779 1430 842">Yes, check for something blocking the air inlet to the burners.</p> <p data-bbox="959 873 1430 968">No, check gas supply pressure, the pressure regulator or for a restriction in the gas line.</p>
Flame too small on top burner.	<ol style="list-style-type: none"> <li data-bbox="508 1094 927 1310">1. Check gas pressure at the top burners under flow. The pressure reading should be 10 inches of water column pressure for LP gas and 4 inches of water column pressure for natural. Is the pressure correct? 	<p data-bbox="959 1094 1430 1157">Yes, incorrect orifice size or restricted orifice.</p> <p data-bbox="959 1188 1430 1310">No, the range is installed on LP and pressure regulator is set for natural. Defective regulator or low incoming gas pressure.</p>
Flame goes out, when valve is turned to the low position.	<ol style="list-style-type: none"> <li data-bbox="508 1356 927 1415">1. Has the bypass orifice been adjusted? 	<p data-bbox="959 1356 1430 1383">Yes, clean or replace the bypass orifice.</p> <p data-bbox="959 1415 1292 1446">No, adjust the bypass orifice</p>
Top burners, not burning properly.	<ol style="list-style-type: none"> <li data-bbox="508 1482 927 1541">1. Are the burner rings and caps installed correctly? <li data-bbox="508 1608 927 1824">2. Check gas pressure at the top burners under flow. The pressure reading should be 10 inches of water column pressure for LP gas and 4 inches of water column pressure for natural. Is the pressure correct? 	<p data-bbox="959 1482 1162 1509">Yes, go to step 2.</p> <p data-bbox="959 1541 1430 1572">No, install burner rings and caps correctly.</p> <p data-bbox="959 1608 1232 1635">Yes, adjust air shutters.</p> <p data-bbox="959 1667 1430 1761">No, checked gas supply pressure, the pressure regulator or for a restriction in the gas line.</p>

FAILURE	CHECK	CORRECTION
One top burner, not burning properly.	1. Is the burner ring and cap installed correctly?	Yes, go to step 2. No, install burner ring and cap correctly.
	2. Is the orifice, aluminum tube or top burner valve restricted?	Yes, remove the restriction or replace the part. No, adjust the air shutter
Top burner valve difficult to turn.	1. Can the valve stem be depressed far enough to unlock the valve.	Yes, replace the valve. No, check the distance between the console and the manifold pipe.
	Igniters do not spark when the burner knob is turned to the lite position.	1. Does a snapping sound occur when the valve is turn to the lite position?
2. Measure the input voltage to one of the top burnerswitches. Is the reading line to neutral?		Yes, go to step 3. No, open wire between range terminal block, and switch.
3. With the valve set to the lite position measure the output voltage of the valve switch. Is the reading line a neutral?		Yes, replace the spark module. No, replace the valve switch
Igniters spark but burner does not ignite.	1. Is the burner ring and cap installed correctly?	Yes, go to step 2. No, install burner ring and cap correctly.
	2. Lite the burner with a match. Is the flame adjusted properly?	Yes, remove and clean the burner ring and cap. No, adjust burner flame.
Igniters continue to spark after burner is ignited.	1. Is the flame adjusted properly?	Yes, remove and clean the burner ring and cap. Check ground wire to module. Replace module. No, adjust burner flame.

FAILURE	CHECK	CORRECTION
Oven does not operate in any function.	1. Are the front panel LEDs indicating a service failure mode?	Yes, checked service failure mode chart. No, go to step 2
	2. Measure the voltage drop between terminal P13 on electronic control board and neutral. Does the meter read line to neutral voltage?	Yes, go to step 3. No, check the high temp limit and wiring between P13 and the range terminal block.
	3. Measure the voltage drop between terminals P1 & P13 on electronic control board. Does the meter read line to line voltage?	Yes, go to step 4. No, check the wiring between P1 and the range terminal block.
	4. Remove power from the range. Disconnect plug P5 from electronic oven control board and measure the resistance between pins eight and nine (oven sensor circuit) in the harness. Is the reading, between 1050 and 1100 ohms?	Yes, go to step 5. No, go to the back of the range and check the oven sensor.
	5. Set the temperature selector to 300°, disconnect plug P 9 from the electronic oven control board and measure the resistance between pins one and three in the harness. Is the reading is between 7000 and 13000 ohms?	Yes, go to step six. No, defective temperature selector or harness.
	6. Set the temperature selector to 300°, disconnect plug P 9 from the electronic oven control board and measure the resistance between pins one and three in the harness. Is the reading is between 2200 and 4300 ohms?	Yes, go to step seven. No, defective temperature selector or harness.
	7. Set the function selector to bake and measure the resistance between pins 4 and 6 of plug P9 in the harness. Is the resistance 7000 and 13000 ohms?	Yes, go to step eight. No, defective function selector or harness.
	7. Set the function selector to bake and measure the resistance between pins 5 and 6 of plug P9 in the harness. Is the resistance 580 and 1720 ohms?	Yes, defective electronic oven control board. No, defective function selector or harness.

FAILURE	CHECK	CORRECTION
Oven temperature off more than 10°	1. Remove power from the range. Disconnect plug P5 from electronic oven control board and measure the resistance between pins eight and nine (oven sensor circuit) in the harness. Is the reading, between 1050 and 1100 ohms?	Yes, go to step 2. No, go to the back of the range and check the oven sensor.
	2. Set the temperature selector to 300°, disconnect plug P 9 from the electronic oven control board and measure the resistance between pins one and three in the harness. Multiply the resistance reading by 32.7%. Measure the resistance between pins two and three. Is this reading within 5% of the first reading?	Yes, replaced the electronic oven control board. No, replace the temperature selector.
Oven does not operate in bake.	1. Does the oven heat in any other function?	Yes, go to step 2. No, refer to oven does not operate.
	2. Disconnect power from the range, remove the two screws holding the bake element to the rear wall of the oven and pull element into the oven. Disconnect one wire from the element and check the resistance of the element it with an ohm meter. Large ovens the resistance should be 17 ohms +/-10%, small ovens the resistance should be 27 ohms +/-10%. Is the reading correct?	Yes, defective electronic oven control board. No, replace the bake element.

FAILURE	CHECK	CORRECTION
Oven does not operate in broil.	1. Does the oven heat in any other function?	Yes, go to step 2. No, referred to oven does not operate.
	2. Disconnect power from the range, remove the two screws holding the broil element to the rear wall of the oven, release the wire clips and pulled element into the oven. Disconnect one wire from the element and check the resistance of the element it with an ohm meter. Large ovens the resistance should be 14 ohms +/-10%, small ovens the resistance should be 27 ohms +/-10%. Is the reading correct?	Yes, defective electronic oven control board. No, replace the broil element.
Oven does not heat in convection bake and the convection fan does not run.	1. Does the oven heat in any other function?	Yes, go to step 2. No, referred to oven does not operate.
	2. Does a convection element heat, and the fan motor run in the convection roast function?	Yes, defective electronic oven control board. No, go to step 3.
	3. Measure the voltage drop between terminals P4 and P10 on the electronic oven control board. Is the reading line to line voltage?	Yes, defective convection element or wiring between the element and control board. Correct the problem and go to step 4. No, defective electronic oven control board.
	4. Measure the voltage drop between terminals, P11 and P15 on the electronic oven control board. Does the meter reading line to line voltage?	Yes, defective convection fan motor or wiring between the fan motor and control board. No, defective electronic oven control board.
Oven heats in convection bake but convection fan does not operate.	1. Does a convection fan run, in the convection roast function?	Yes, replace electronic oven control board. No, go to step 2.
	2. Measure the voltage drop between terminals, P11 and P15 on the electronic oven control board. Does the meter reading line to line voltage?	Yes, defective convection fan motor or wiring between the fan motor and control board. No, replace electronic oven control board.

FAILURE	CHECK	CORRECTION
Oven does not heat in convection bake but the convection fan runs.	1. Does the oven heat in any other function?	Yes, go to step 2. No, referred to oven does not operate.
	2. Does a convection element heat, in the convection roast function?	Yes, replace electronic oven control board. No, go to step 3.
	3. Measure the voltage drop between terminals P4 and P10 on the electronic oven control board. Is the reading line to line voltage?	Yes, defective convection element or wiring between the element and control board. No, replace electronic oven control board.
Oven does not heat in convection roast and the convection fan does not run.	1. Does the oven heat in any other function?	Yes, go to step 2. No, referred to oven does not operate.
	2. Does a convection element heat, and the fan motor run in the convection bake function?	Yes, replace electronic oven control board. No, go to step 3.
	3. Measure the voltage drop between terminals P4 and P10 on the electronic oven control board. Is the reading line to line voltage?	Yes, defective convection element or wiring between the element and control board. Correct the problem and go to step 4. No, replace electronic oven control board.
	4. Measure the voltage drop between terminals, P11 and P15 on the electronic oven control board. Does the meter reading line to line voltage?	Yes, defective convection fan motor or wiring between the fan motor and control board. No, replace electronic oven control board.

FAILURE	CHECK	CORRECTION
Oven does not heat in convection roast but the convection fan runs.	1. Does the oven heat in any other function?	Yes, go to step 2. No, referred to oven does not operate.
	2. Does a convection element heat, in the convection bake function?	Yes, replace electronic oven control board. No, go to step 3.
	3. Measure the voltage drop between terminals P4 and P10 on the electronic oven control board. Is the reading line to line voltage?	Yes, defective convection element or wiring between the element and control board. No, replace electronic oven control board.
Oven heats in convection roast but convection fan does not operate.	1. Does a convection fan run, in the convection bake function?	Yes, replace electronic oven control board. No, go to step 2.
	2. Measure the voltage drop between terminals, P11 and P15 on the electronic oven control board. Does the meter reading line to line voltage?	Yes, defective convection fan motor or wiring between the fan motor and control board. No, replace electronic oven control board.
LEDs do not light.	1. Check the wiring harness between the electronic oven control board and the interface board.	Defective harness, replace the wire harness between the electronic oven control board and the interface board. Good harness, replace the interface board, if this does not correct the problem replace the electronic oven control board.
	One LED does not light.	1. Check the wiring harness between the electronic oven control board and the interface board.
Cooling fan does not operate.	1. Is the fan blade restricted?	Yes, remove the restriction. No, go to step 2.
	2. Measure the resistance between pins one and three in the harness of plug P5. Does the meter reading, 10 ohms +/-10%?	Yes, defective electronic oven control board. No, defective cooling fan motor.

FAILURE	CHECK	CORRECTION
Oven does not operate in self-cleaning.	1. Are the front panel LEDs indicating a service failure mode?	Yes, checked service failure mode chart. No, go to step 2
	2. Have the oven racks and side glides been removed?	Yes, go to 3. No, remove the racks and side glides.
	3. Does the oven heat in the baked function?	Yes, go to 4. No, refer to oven will not operate in bake function.
	4. Does the oven door lock?	Yes, defective electronic oven control board. No, go to step 5.
	5. Disconnect power from the range. Remove plug P5 and measure the resistance between pins five & ten in the harness. Does the meter read zero or infinity?	Zero, go to step 6. Infinity, defective rack removal switch or wiring to the switch.
	6. Measure the resistance between pins one and two in the harness of plug P5. Does the meter read 2500 ohms +/-10%?	Yes, replace electronic oven control board. No, defective lock motor or wiring between the electronic oven control board and the lock motor.
One oven light does not light.	1. Check the oven light bulb.	Good bulb, defective transformer or wiring between the transformer and the socket. Defective bulb, replace the bulb.
	Both oven lights do not light.	1. Check the oven light bulbs.
2. Check the light switch.		Good switch, defective transformer or wiring. Defective switch, replace the switch.

SECTION E - TEARDOWN

This section will describe how to remove components from the range. Unless stated, the procedure will be the same on all models. Unless stated, reverse the procedure to reinstall the component.

⚠ WARNING Always remove electrical power from the range when working in an area where electrical power is present.

⚠ WARNING Always turn the gas off to the range before opening any gas piping.

Note: Not all components are in all models.

Removing the top grates:

1. The top grates lift off.



Removing the burner caps:

1. Remove the top grates.

2. The burner caps lift off.



Removing the burner rings:

1. Remove the top grates and the burner caps.
2. The burner rings lift off.



Removing the burner head:

1. Remove the top grates, burner cap and ring.

2. Using the burner tool, unscrew the brass ring holding the burner head to the burner tube and lift the burner out of the drip pan.



2. Remove the C clamp, holding the spring and igniter to the burner head.



3. Unplug the igniter wire and lift the burner head, and igniter off.



3. Lift the igniter out of the burner head.

Removing the knobs:

1. The shafts of the knobs are D shaped and the knobs pull straight off.



Removing the igniters:

1. Remove the burner head.

Removing the knob bezels:

1. Remove the knob.
2. Remove the two screws holding the bezel to the control panel.



Removing the backsplash:

1. Remove the grates.
2. Remove the (4) screws, two on each side, from the rear of the range holding the backsplash to the side panels.



3. Remove the (4) screws holding the front of the backsplash to the burner box and lift the backsplash off.



Removing the spill tray:

1. Remove the grates and burner heads.
2. Removed the (3) screws holding the control panel to the front spill tray support.



3. Lift the front of the spill tray up, to clear the control panel, and lift the spill tray out.



Removing the burner tube:

1. Remove the spill tray.
2. Using a 5/16 inch driver, removed the two screws holding the burner tube to the burner box.

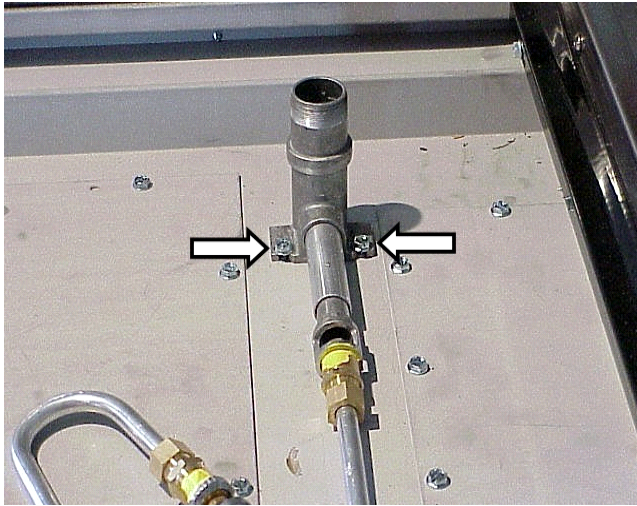

3. Slide the burner tube off of the air shutter tube.

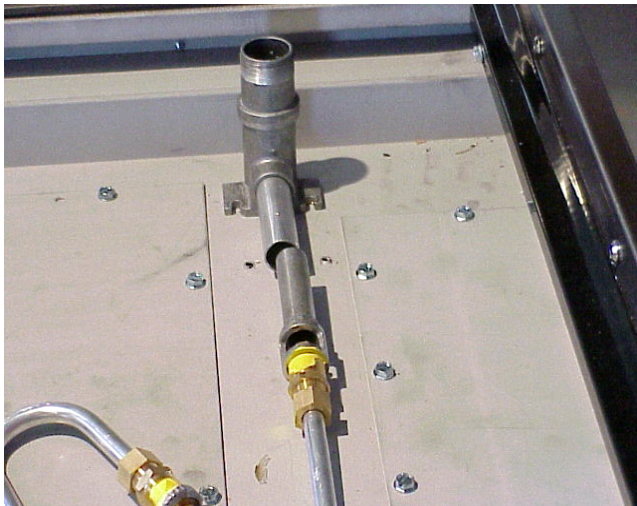

Removing the air shutter tube:

1. Remove the spill tray and the burner tube.

2. Using two adjustable or 9/16 inch wrenches, hold the orifice tube with one and turn the air shutter tube off with the other.

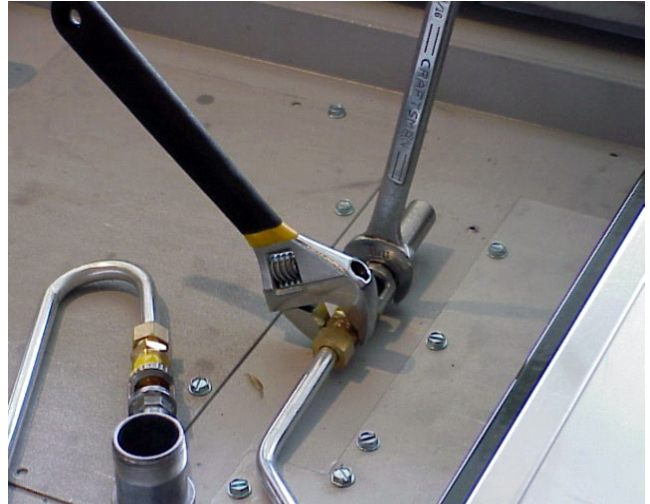

Removing the orifice:

1. Remove the spill tray and the air shutter tube.
2. Using a 10 mm socket, remove the orifice from the orifice assembly tube while holding the assembly with a 9/16 inch wrench.

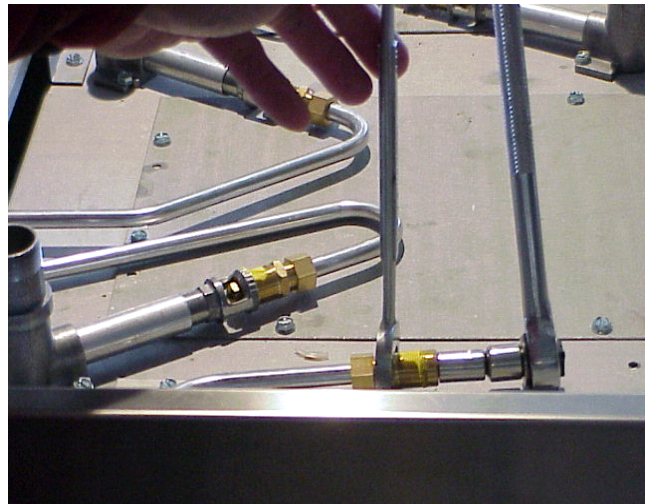

Removing the front spill tray support trim:

1. Remove the spill tray.

2. Remove the (4) screws holding the front spill tray trim to the front spill tray support.



Removing the front spill tray support:

1. Remove the spill tray and the front spill tray support trim.
2. Remove the (3) screws holding the support to the burner box and lift the support out.

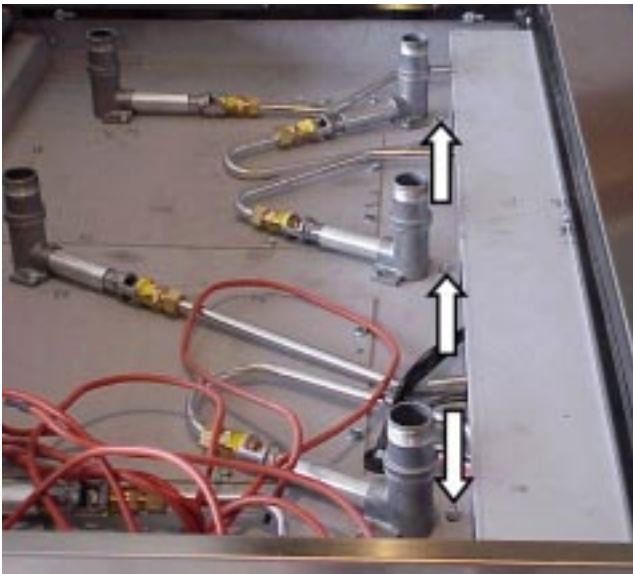

Removing the side spill tray support:

1. Remove the spill tray.

2. Remove (2) screws holding the side support to the burner box and lift the support off.

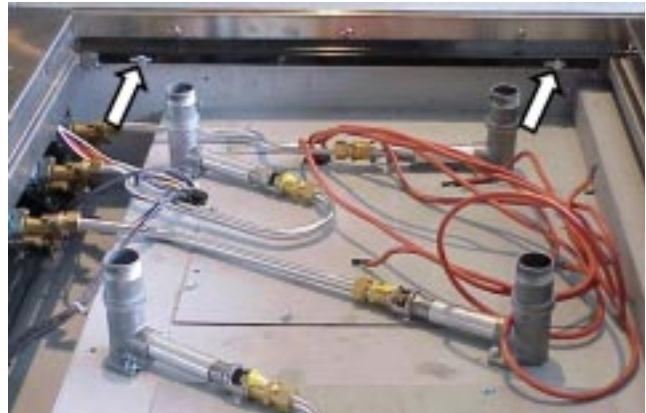

Removing burner tubing assembly:

1. Remove the spill tray and the front spill tray support.
2. Remove the (2) screws holding the burner tube to the burner box.
3. Using a 5/8" wrench, disconnect the aluminum tubing from the valve and lift the tubing assembly out.



Removing igniter module:

1. Disconnect power, remove the spill tray and left rear burner tube.
2. Remove the (6) screws holding the igniter module access panel to the burner box and remove the panel.



3. Remove the screw holding the ground wire to the top of the oven.

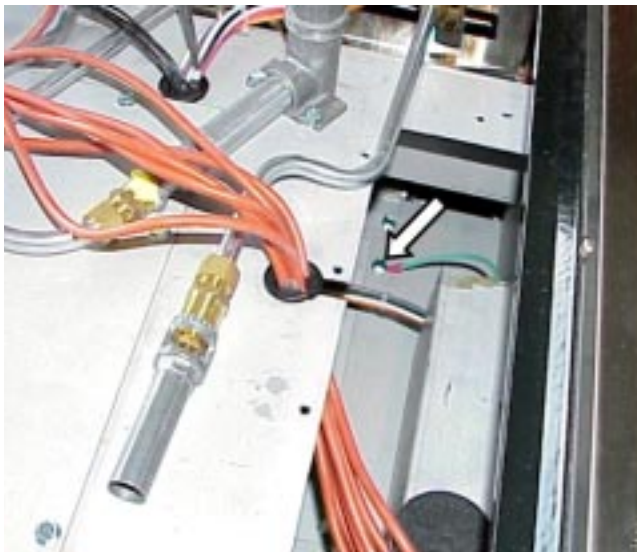

4. Remove the screw holding a module cover to the side of the range.



5. Remove the cover and disconnect the wires to the igniters.
6. Remove the screw holding the harness plug to the module, disconnect the plug and lift the module out.

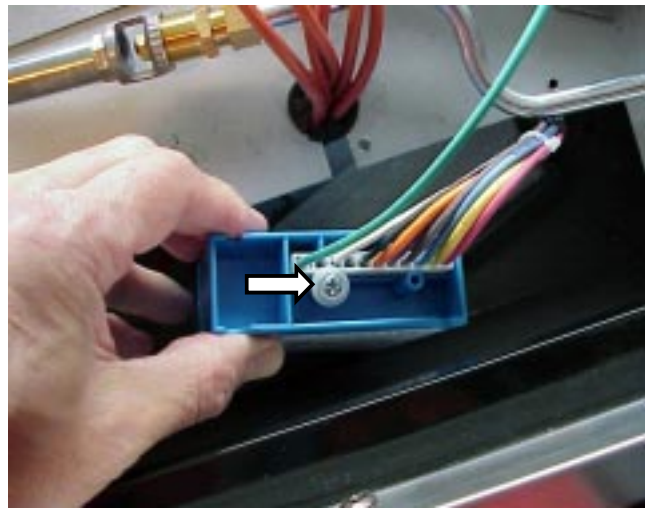

Removing electronic oven control board:

1. Disconnect power, remove the spill tray, left front and rear center burner tube assemblies.
2. Remove the (8) screws holding the electronic oven control board access panel to the burner box and remove the panel.

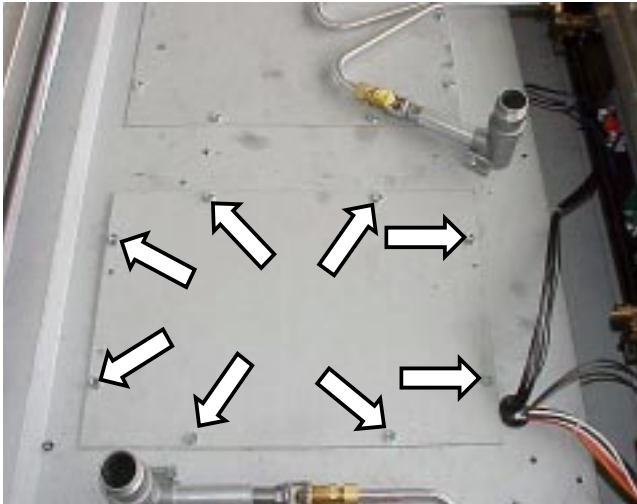

3. Unplug the wiring harnesses and disconnect the wiring from the electronic oven control board.
4. Remove the (4) screws (two on each side), holding the electronic oven control board mounting bracket to the top of the oven and lift the bracket and control board out.

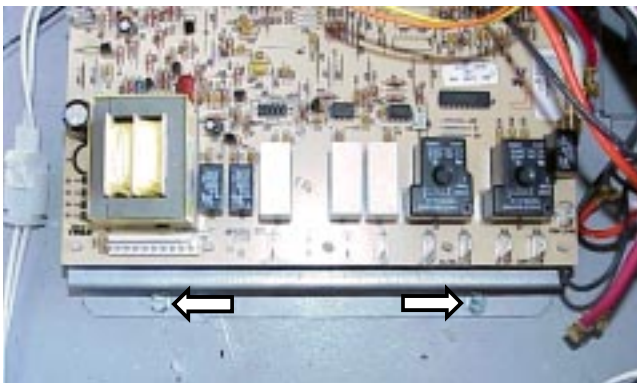

5. Release the electronic oven control board from the mounting bracket by releasing the (10) plastic rivets holding the board to the bracket.

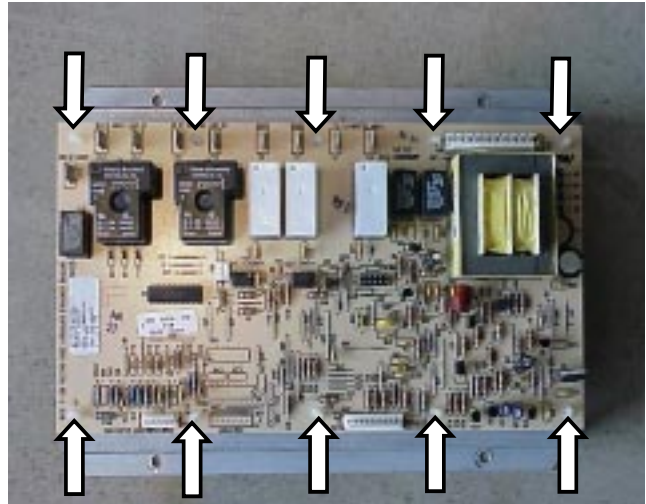

Removing oven light transformer:

1. Disconnect power, remove the spill tray, right front and front center burner tube assemblies.
2. Remove the (8) screws holding the transformer/oven high temp limit access panel to the burner box and remove the panel.

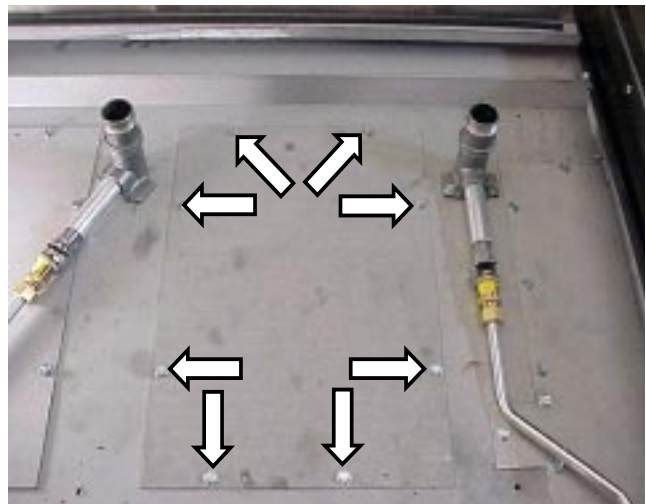

3. Disconnect the wires from the transformer, remove the two screws holding the transformer to the top of the oven and lift the transformer out.

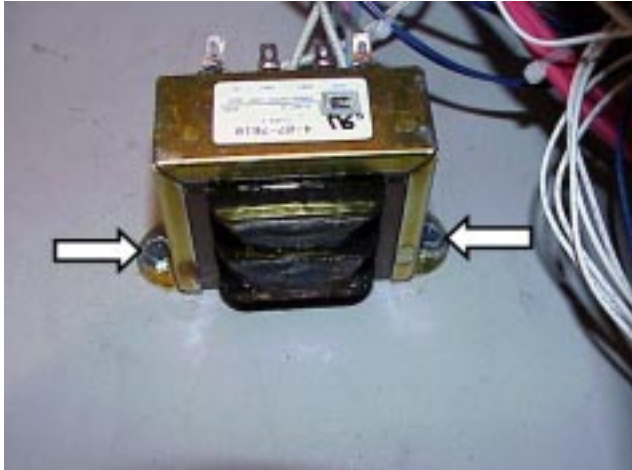

3. Disconnect the wires from the oven high temp limit, remove the two screws holding the oven high temp limit to the top of the oven and lift the oven high temp limit out.

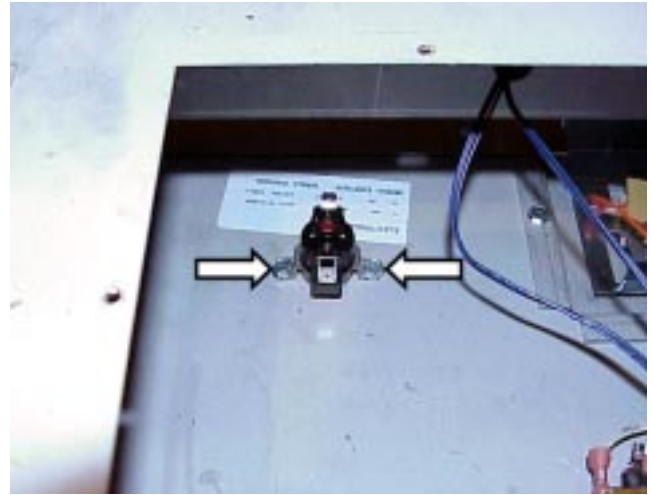

Removing oven high temp limit:

1. Disconnect power, remove the spill tray, right front and front center burner tube assemblies.
2. Remove the (8) screws holding the transformer/oven high temp limit access panel to the burner box and remove the panel.

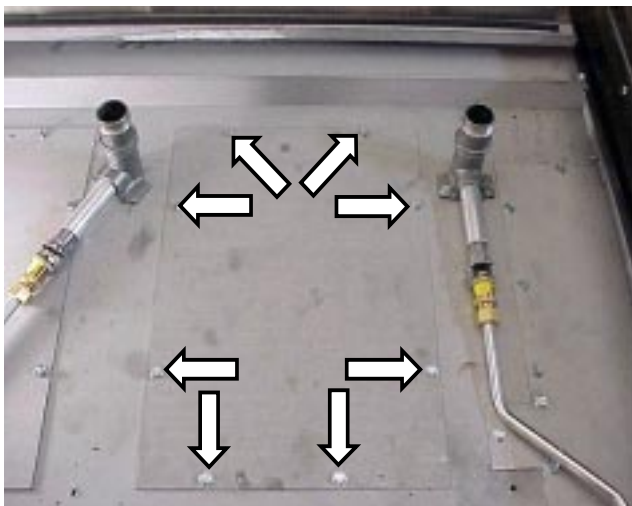

Removing oven door handle:

1. Open the oven door and remove the (2) plastic caps, covering the door handle screw openings.



- Remove the (2) screws holding the door handle to the outer door liner.

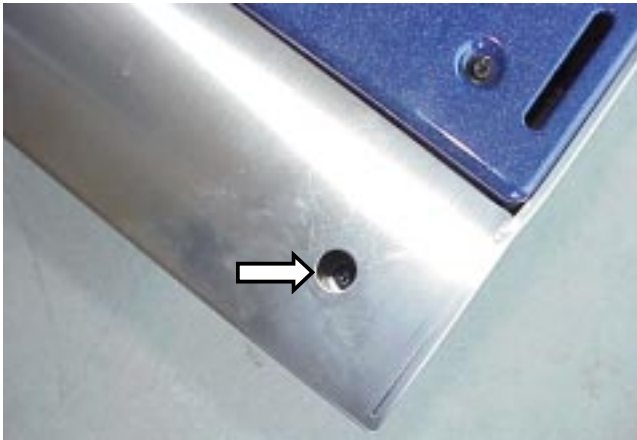

Removing the oven door:

- Rotate the hinge locks to the door so that when the doors is closed they will take the spring pressure off the hinges.



- Close the door until you feel, the hinges released from the rollers and then lift out on the door.

Removing the oven door seal:

- Open the oven door.

- The oven door seal is held to the inner liner of the oven door by spring clips and can be pulled straight off.

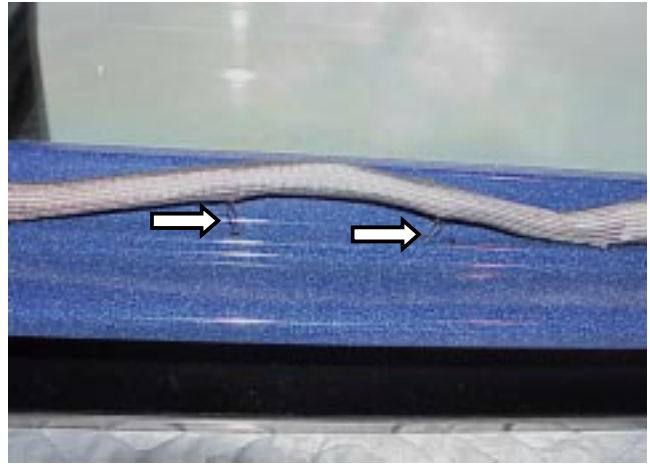

Removing the oven door inner liner assembly:

- Remove the oven door and place it on a soft surface.

Note: To remove some of the screws in the door, you will need a number 20 star bit.

- To remove the door inner liner assembly, from the door outer liner assembly. Remove the (2) screws on the bottom, one on each end, and the (2) screws at the top of the inner liner. Then lift the inner liner assembly out of the outer liner assembly.

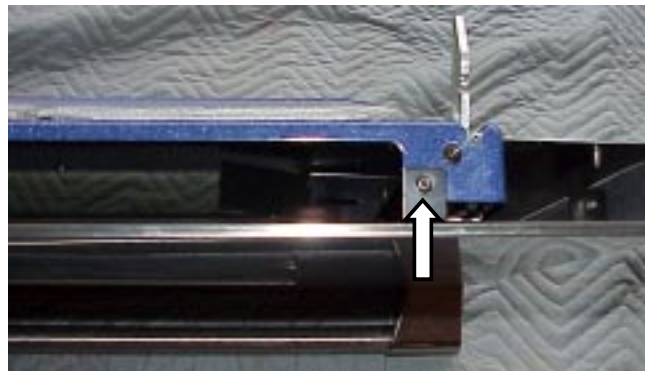



Removing the oven door cams and springs:

1. Remove the inner door liner assembly.
2. Remove the (2) screws holding the spring shield to the inner liner and lift the spring shield off.

3. Remove the screw from the bottom of the inner liner and lift the spring in cam assembly out of the inner liner.

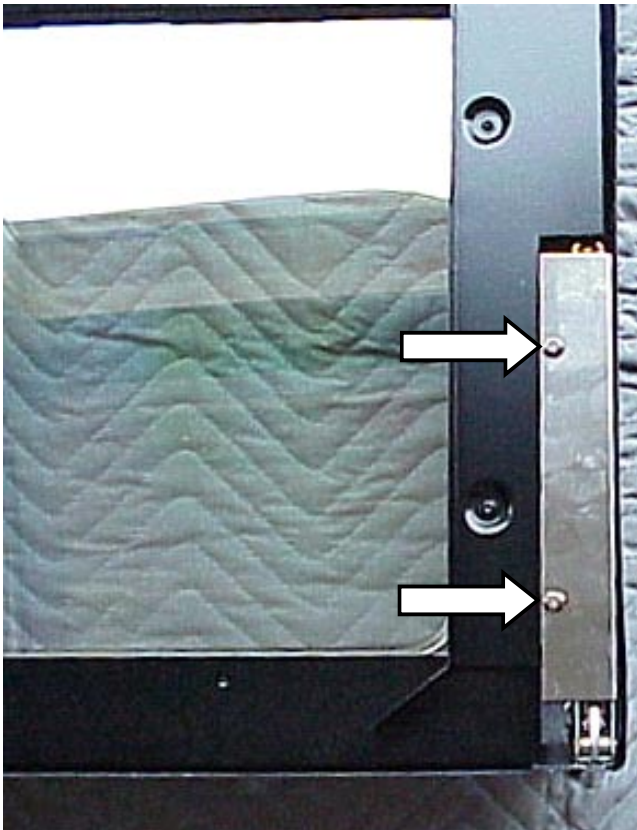
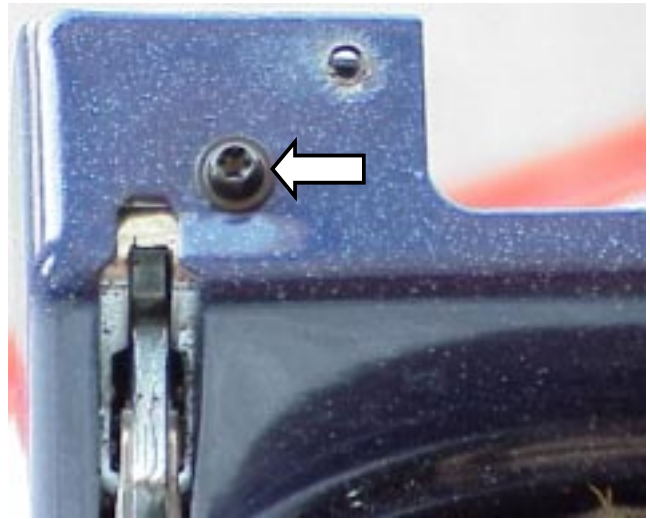

Removing the oven door air directional baffle:

1. Remove the inner door liner assembly.
2. Remove the (4) screws holding the air directional baffle to the air baffle and lift the air directional baffle off.



Removing the oven door air baffle:

1. Remove the air directional baffle.

- Remove the (4) screws holding the air baffle to the inner glass shield and lift the air baffle off.



Removing the oven door inner glass package shield:

- Remove the air baffle.
- Remove the (4) screws holding the inner glass package shield to the inner liner and lift the shield off.



Removing the oven door inner glass package:

- Remove the inner glass package shield and the glass package will lift out.



Removing the oven door inner glass package seal:

- Remove the inner glass package and the seal will lift out.



Removing the intake air grill:

- Open the oven door.

2. Remove the (4) screws holding the grill to the front of the range.

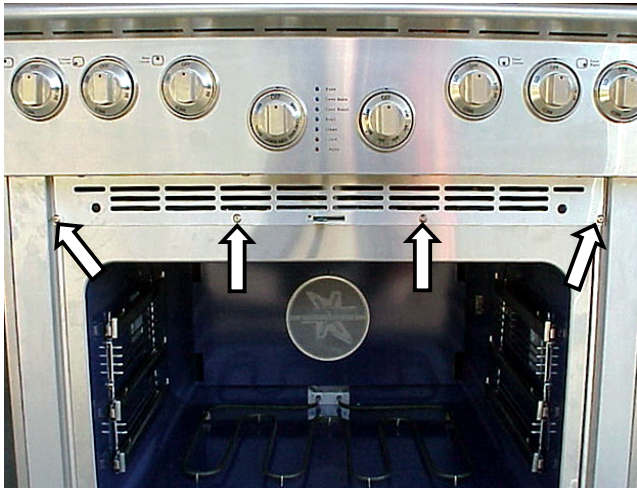

3. Remove the (4) screws holding the grill to the control panel and lift the grill off.

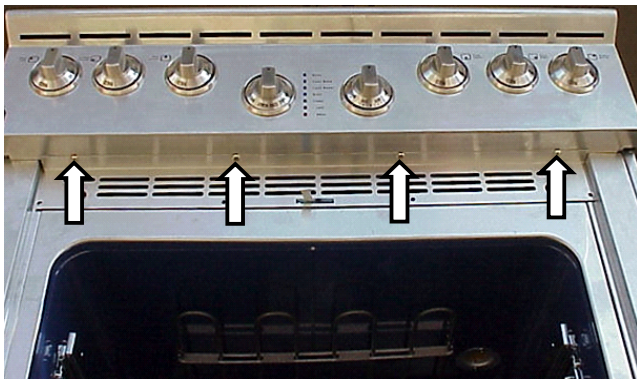

Removing the control panel:

1. Disconnect power and remove the spill tray.
2. Remove the front spill tray support, the top burner knobs and the air intake grill.
3. Disconnect the wires from the interface board, the functions selector and the temperature selector.

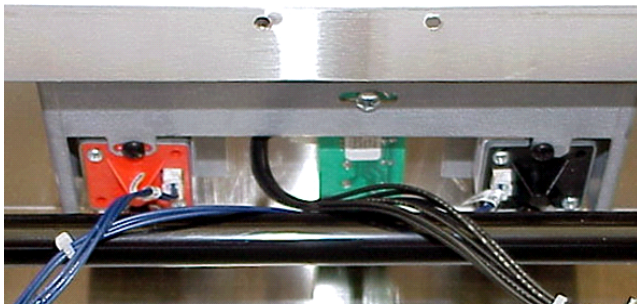

4. Disconnect the wires from the oven light switch.

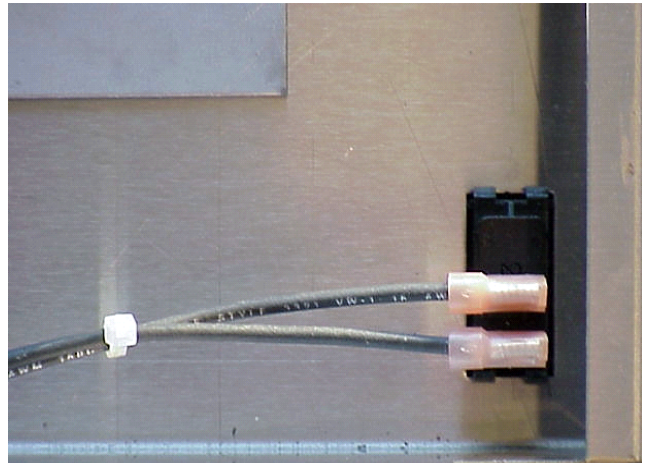

5. Using an 11/32 socket, remove the (2) nuts from the bolts holding the control panel to the manifold pipe and lift the control panel off.

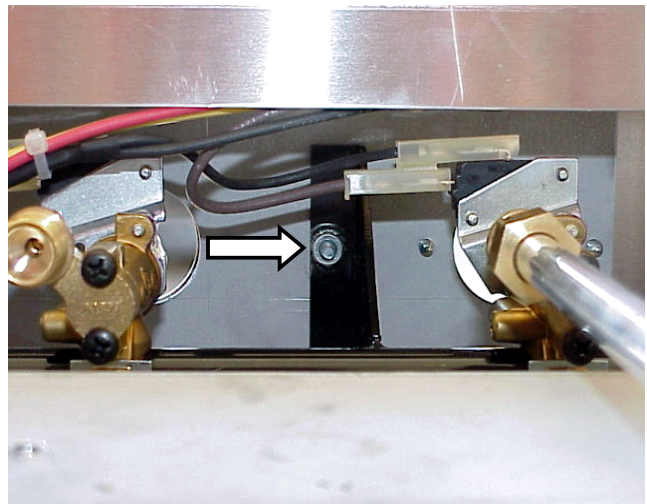

Removing the temperature selector:

1. Disconnect power and remove the control panel.
2. Remove the temperature selector knob.

3. Remove the two screws holding the temperature selector to the control mounting plate, pushed the control forward and to the side, and pull the control out.

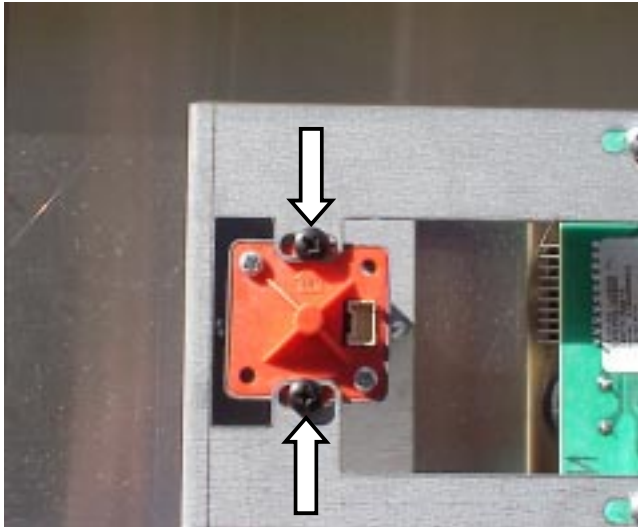

Removing the interface board:

1. Disconnect power and remove the control panel.
2. Remove the two screws holding the interface board to the control mounting plate, turned the board and lifted it out.

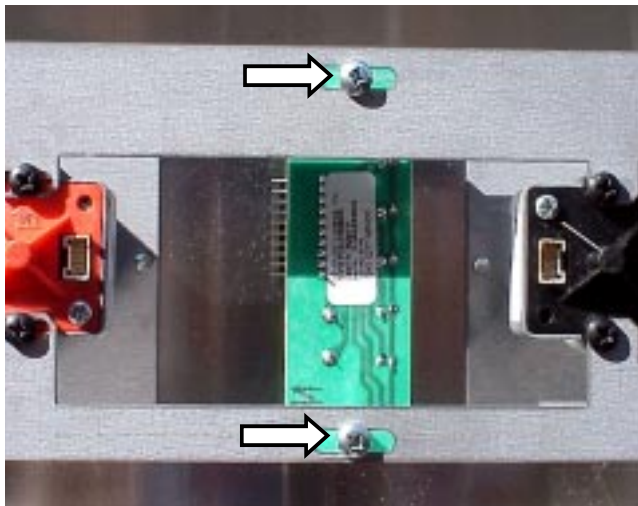

Removing the function selector:

1. Disconnect power and remove the control panel.
2. Remove the function selector knob.

3. Remove the two screws holding the function selector to the control mounting plate, pushed the control forward and to the side, and pull the control out.

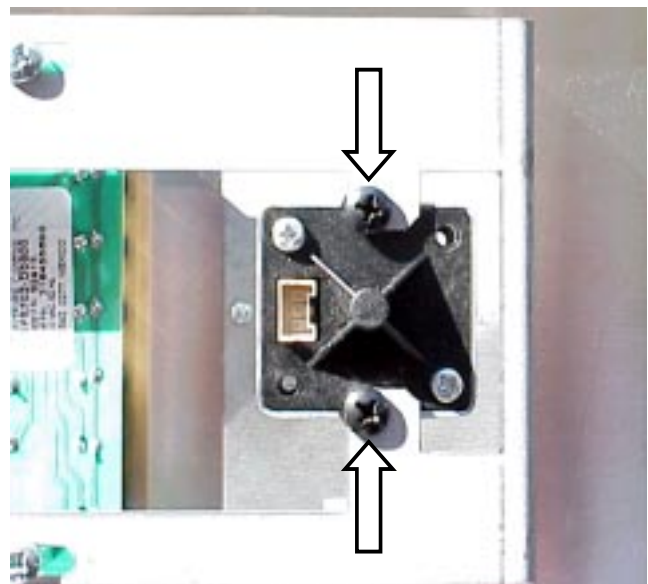

Removing the top burner igniter switch:

1. Disconnect power and remove the control panel.
2. Disconnect the wire from the switch, remove the (2) screws holding the switch to the valve and lift the switch off.

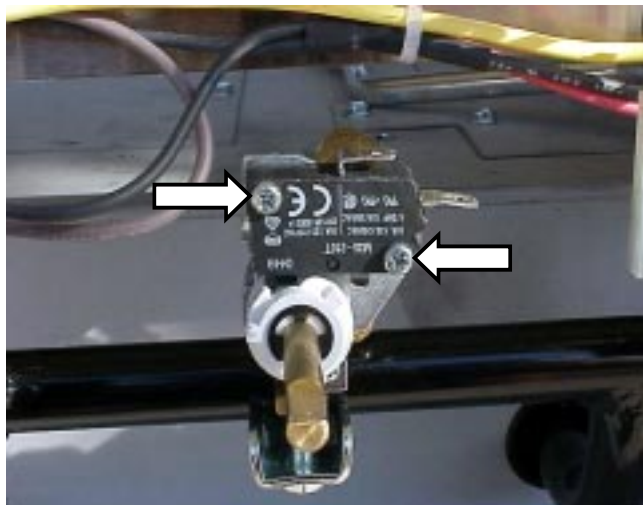

Removing the top burner valve:

1. Disconnect power, turn off the gas supply and remove the control panel.

2. Remove the top burner igniter switch.
3. Using a 5/8" wrench, disconnect the aluminum tubing from the rear of the valve.



3. Remove the (8) screws holding the manifold access panel to the burner box and remove the panel.

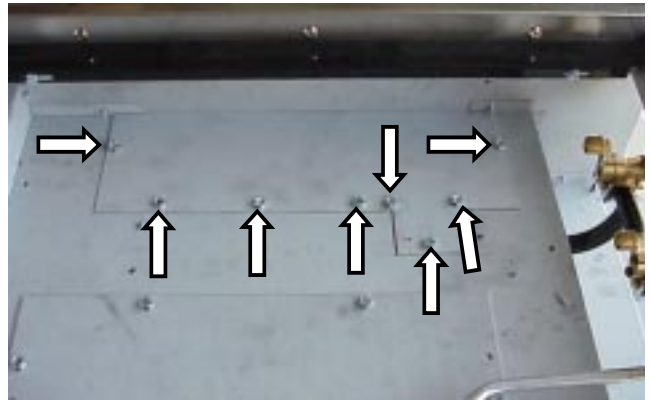

4. Disconnect the aluminum tubing from the rear of the valves or if the manifold pipe is to be replaced remove the valves.
5. Using a 15/16" wrench disconnect the aluminum tubing from the manifold pipe and pull the manifold pipe out the front.

4. Using a 5/16" socket, removed the bolt clamping the valve to the manifold pipe and lift the valve off.

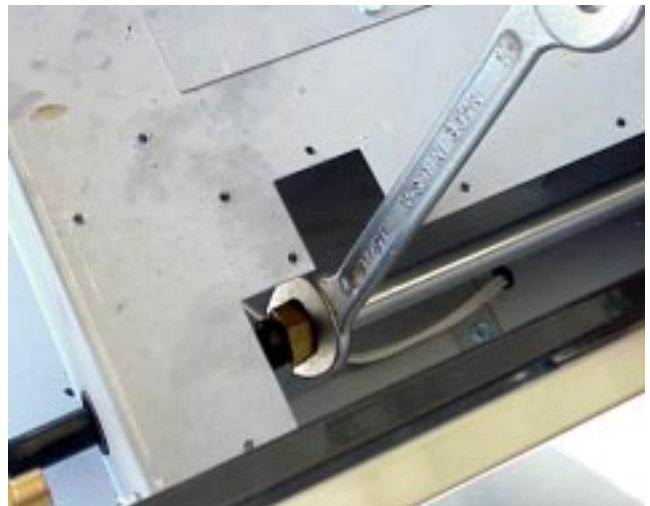
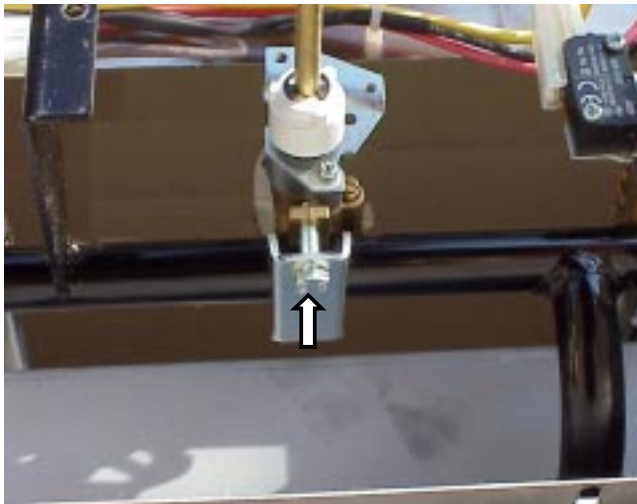

Removing the kick panel assembly:

1. Remove the oven door.

Removing the manifold pipe:

1. Disconnect power, turn off the gas supply and remove the control panel.
2. Remove the burner tubing assembly for the right rear burner.

- Remove the (3) screws holding the kick panel assembly to the front of the range.

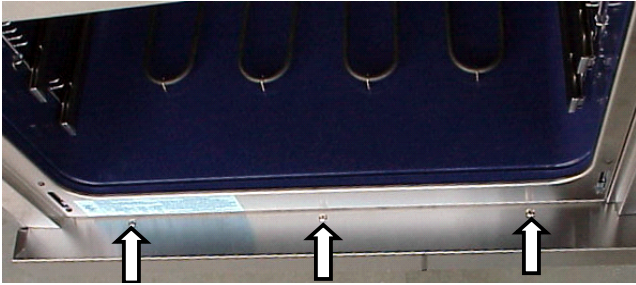

- Pull the kick panel forward to disengage the pins from the side panels.

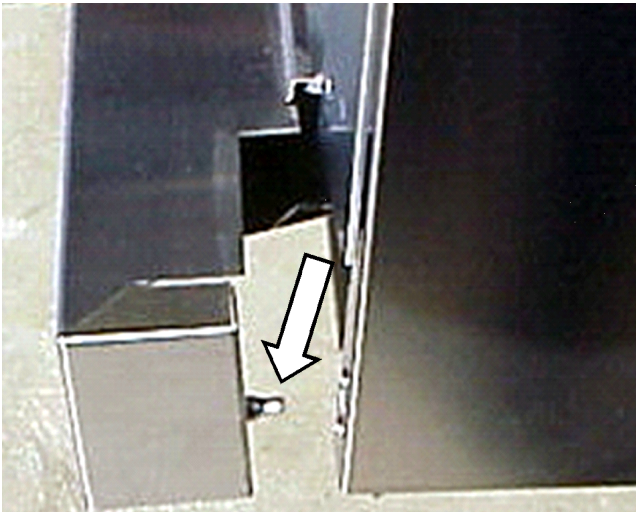

Removing the bake element:

- Disconnect power and open the oven door.
- Remove the (2) screws holding the element to the rear wall of the oven, pull the element into the oven and disconnect the wires.

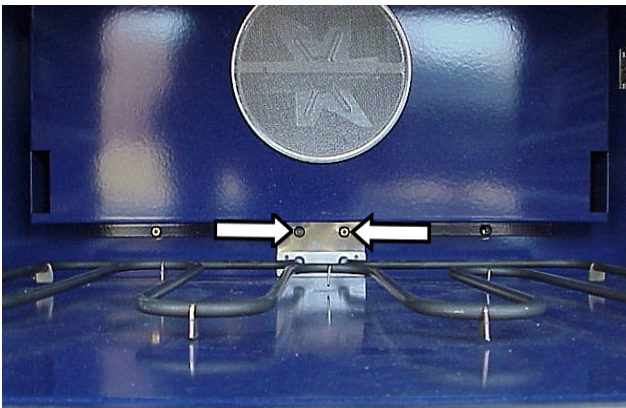

Removing the convection filter screen:

- Open the oven door.
- Lift up on the screen to disengage the tabs from the bar.

Removing the broil element:

- Disconnect power and open the oven door.
- Remove the (2) screws holding the broil element to the rear wall of the oven.

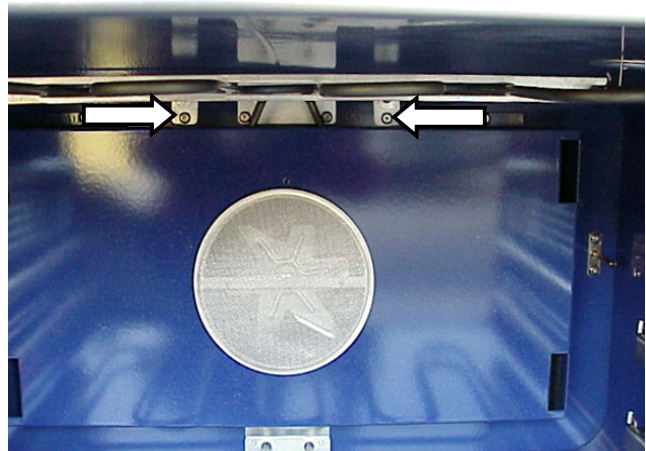

- Disconnect the (2) wire hangers, holding element to the ceiling of the oven.

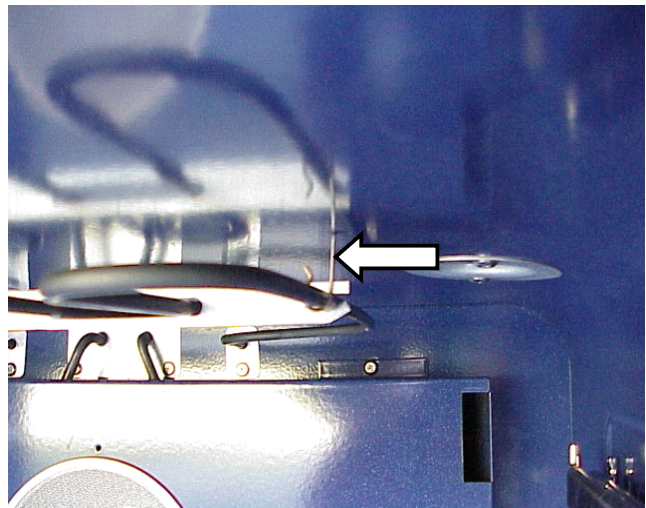

3. Disconnect the (2) wire hangers, holding element to the ceiling of the oven.

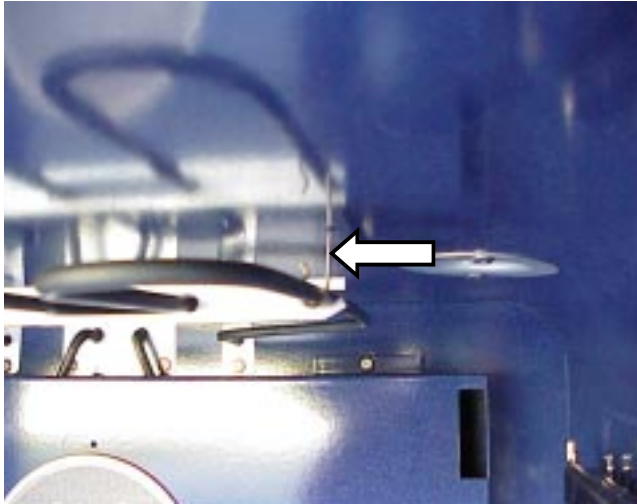

2. Using a 17/32" socket removed the nut holding the fan blade to the shaft, by turning it clockwise and lift the fan blade off.

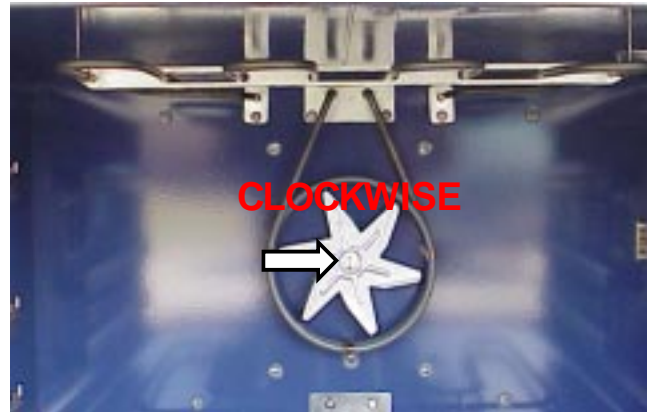

Removing the convection element:

4. Pull the broil element into the oven and disconnect the wires.

Removing the convection baffle:

1. Open the oven door.
2. Remove the (4) screws holding the baffle to the rear wall of the oven and lift the baffle off.

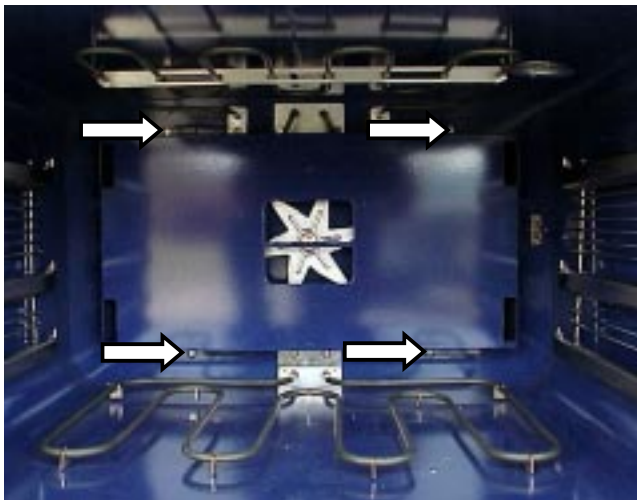

Removing the convection fan blade:

1. Open the oven door and remove the convection baffle.

1. Disconnect power and remove the convection baffle.

2. Remove the (3) screws, two at the top them one at the bottom, holding the convection element to the rear wall of the oven. Pull the element into the oven and disconnect the wires.



Removing the smoke eliminator:

1. Open the oven door.

2. Remove the (2) screws holding the smoke eliminator to the top of the oven and dropped the eliminator into the oven.

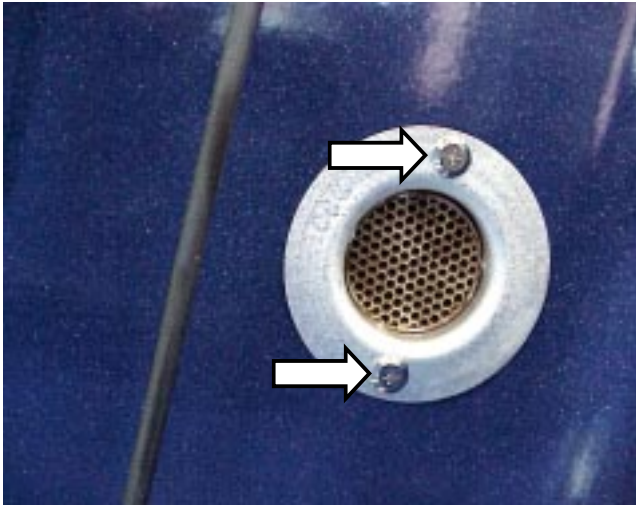

2. Remove the (2) screws holding the oven sensor to the rear wall of the oven and pull a sensor and the wires out. When reinstalling the sensor push the wires back through the hole and pull them tight from the rear of the oven.

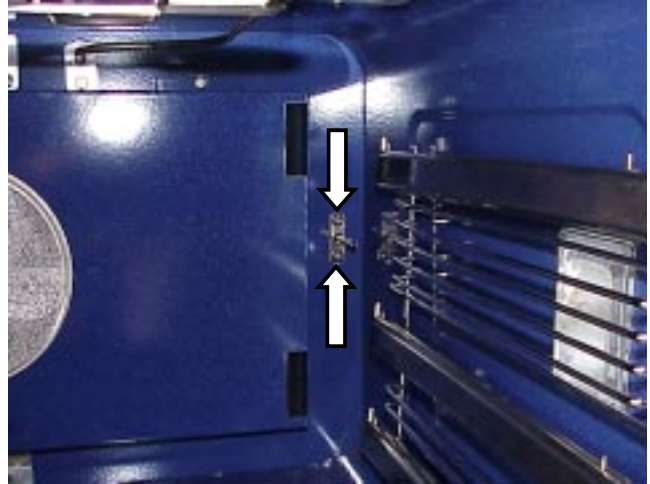

Removing the oven sensor:

1. Remove the pressure regulator access panel and disconnect the (2) sensor wires.



Removing the rack support:

1. Open the oven door.
2. Lift up and out on the bottom front corner of the support to disengage it from the side of the oven.



Removing the oven light:

1. Open the oven door and remove the rack support.

2. The light cover pulls straight off and the light bulb pulls straight out.



Removing the oven door latch assembly:

1. Disconnect power and remove the air intake grill.
2. Disconnect the wiring from the phase switch, lock switch and the latch motor.
3. Remove the (2) screws holding the latch mechanism to the top of the oven and lift the mechanism out.



Removing the pressure regulator access panel:

1. Remove the (2) screws holding the pressure regulator access panel to the back cover.



Removing the back cover:

1. Disconnect power from the range.

2. Remove the (8) screws, four on each end, holding the back cover to the side panels and lift the back cover off.

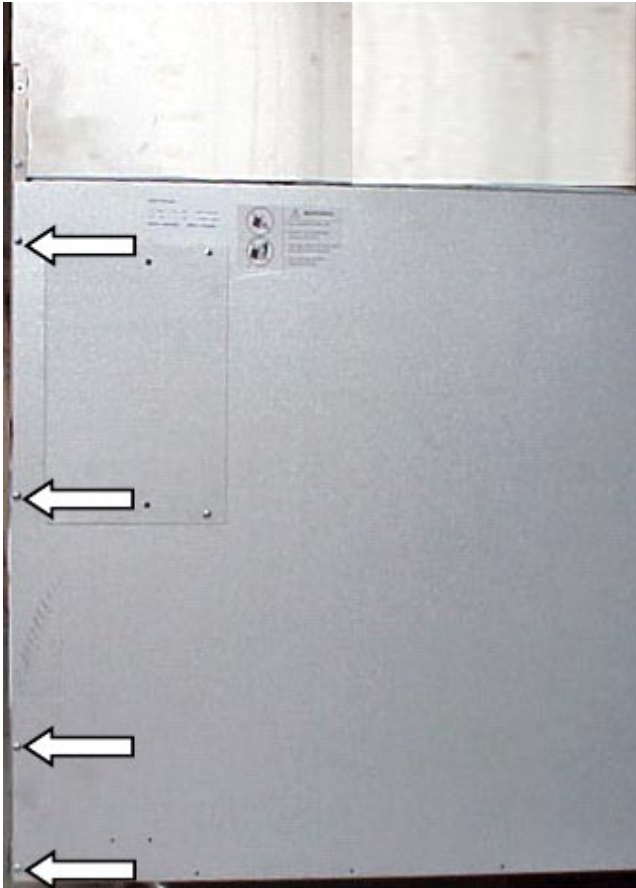

Removing the convection fan motor:

- 1. Disconnect power and remove the back cover.
- 2. Remove the convection fan blade and disconnect the wires from the motor.

3. Using a ¼” nut driver, remove the three screws holding the motor to the rear of the oven and pull the motor straight back.

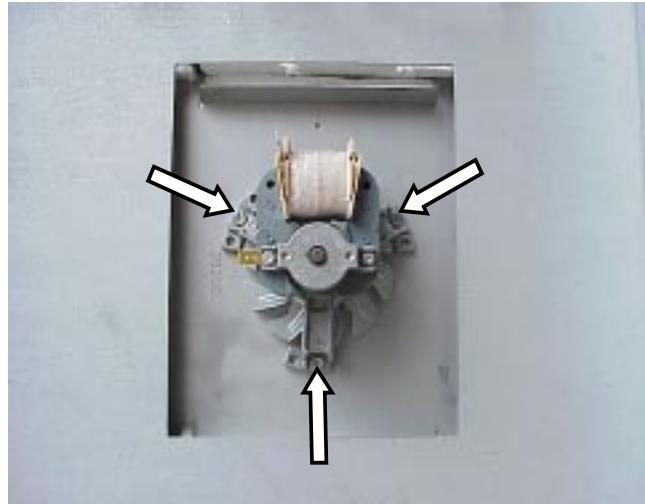

Removing the rear air channel cover :

- 1. Disconnect power and remove the back cover.
- 2. Remove the (8) screws holding the cover to the air channel and lift the cover off.

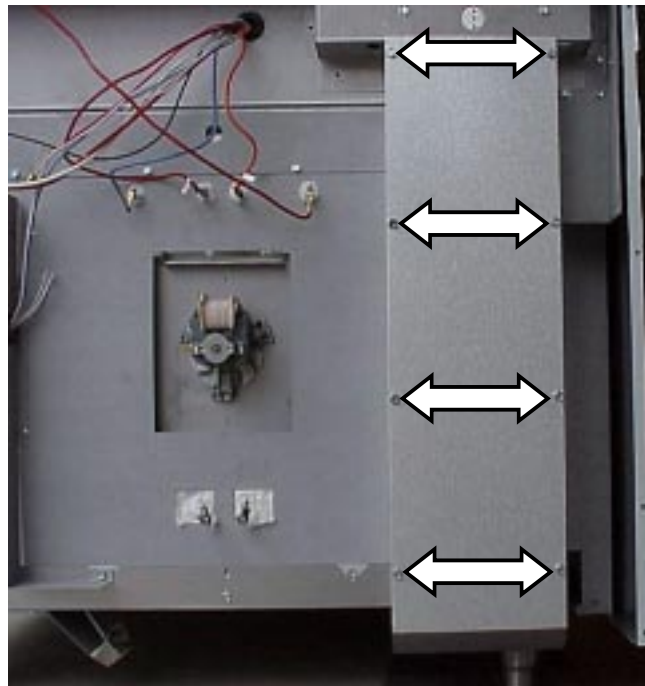

Removing the rear air channel:

1. Disconnect power, remove the back cover and the rear air channel cover.
2. Remove the (5) screws holding the air channel to the rear the oven and lift it off.

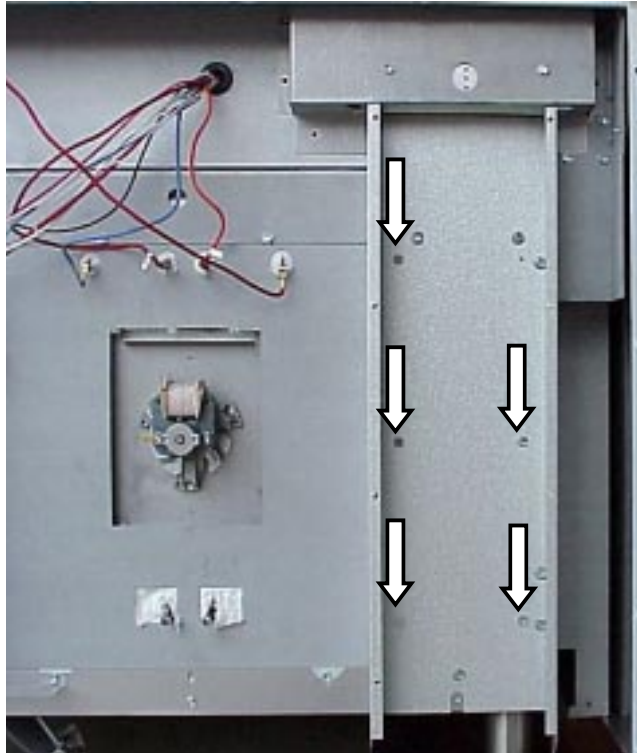

Removing the cooling fan assembly :

1. Disconnect power, remove the back cover, the rear air channel cover and the rear air channel.

2. Remove the (7) screws holding the cooling fan cover to the rear of the oven. Pull the assembly back and disconnect the wires to the fan motor.

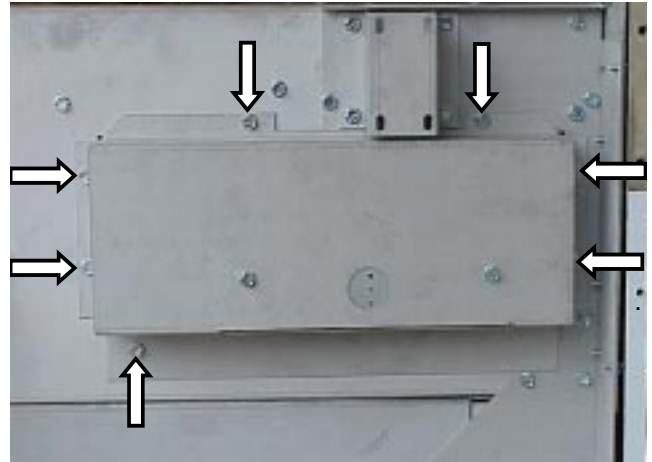

Removing the cooling fan assembly cover:

1. Disconnect power and the cooling fan assembly.
2. Remove the (2) screws holding the cover to the assembly and lift the cover off.

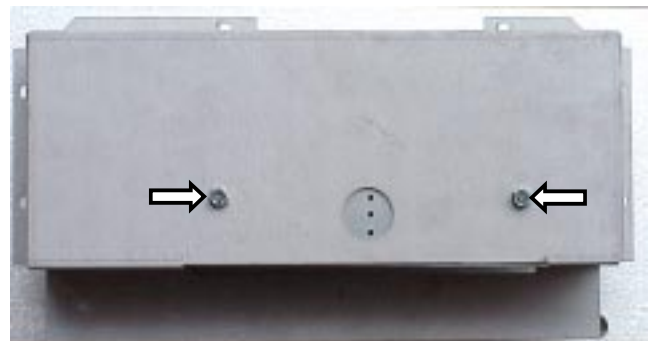

Removing the remove oven racks switch:

1. Disconnect power and remove the back cover.

- Remove the (2) screws holding the switch to the mounting bracket. Drop to switch down and disconnect the wires.

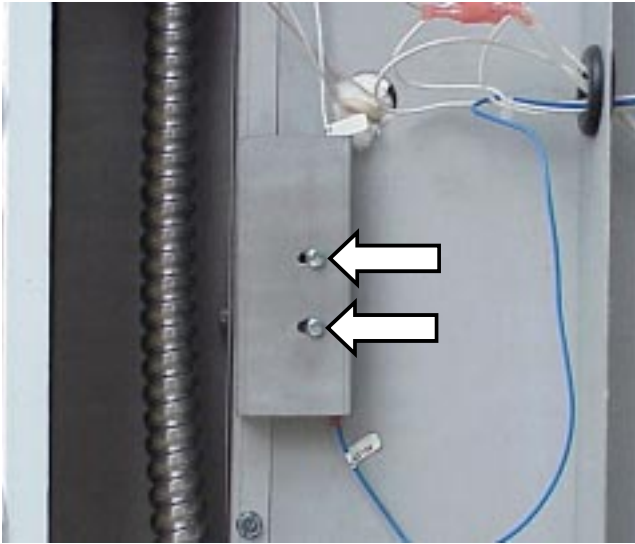

Removing the pressure regulator:

- Disconnect power, turn off the gas supply and remove the back cover.
- Disconnect the incoming gas line from the pressure regulator.
- Using a 15/16" wrench, disconnect the aluminum tubing, while holding the regulator.

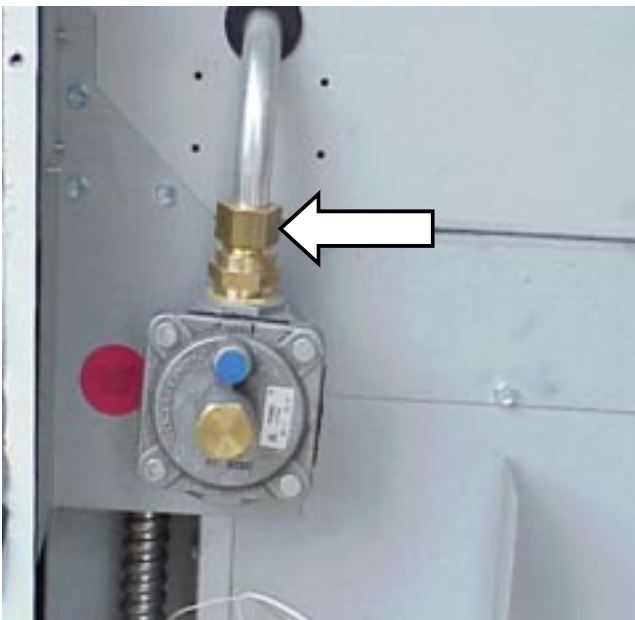

Removing the side panels:

- Disconnect power and remove the spill tray and backslash.
- Remove the kick panel and the (4) screws holding the back cover to the side panel.
- Remove the (3) screws holding the side panel to the inside of the burner box and loosen the (2) screws holding the spill tray support on that side.

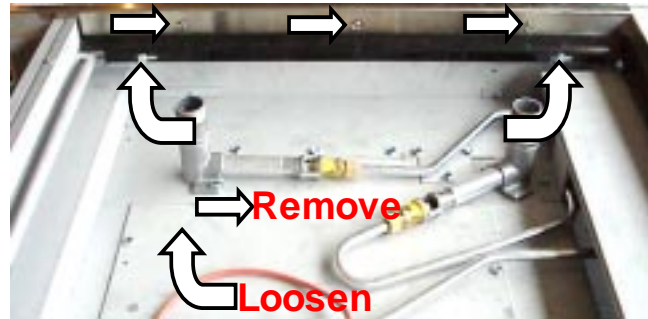

- Pull out on the bottom of the side panel until the front pins release.

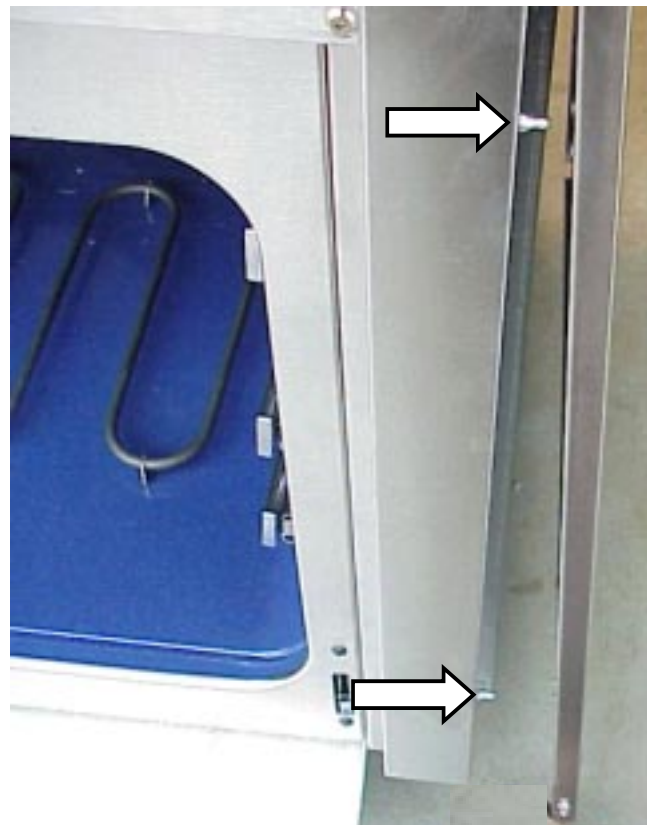

5. Grab the bottom rear corner of the side panel and rotate the side panel counterclockwise until the front edge of the side panel is parallel with the edge of the burner box. Then, pullout on the front corner of the side panel to disengage it from the burner box.

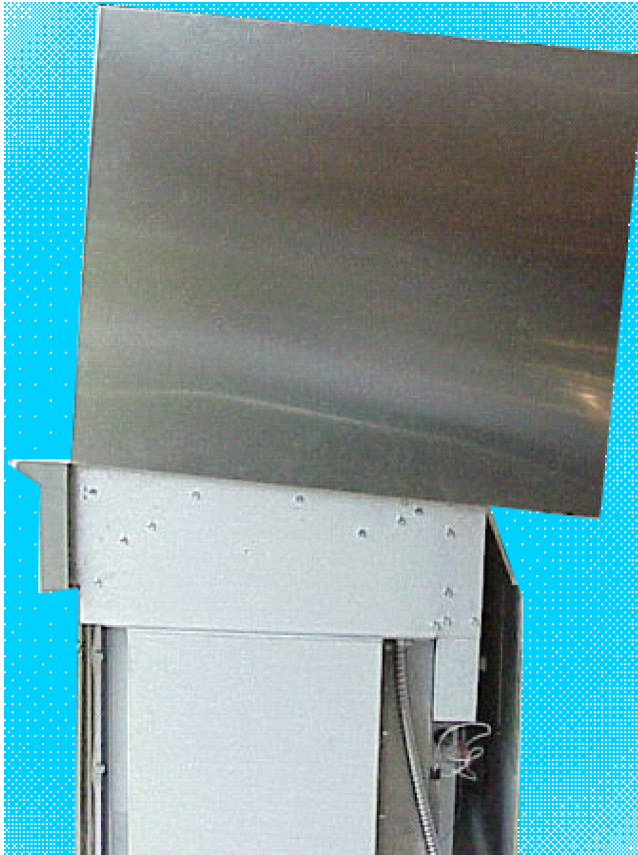

2. Remove the (3) screws holding the filler to the burner box.

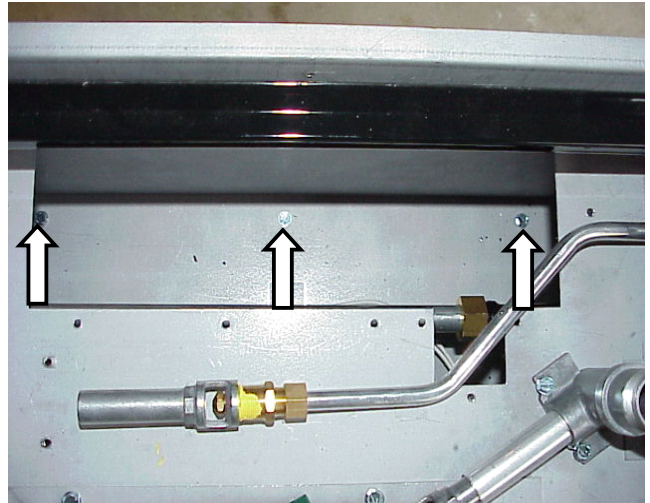

3. Remove the (7) screws, four in the front and three in the rear, holding the filler to the side of the oven.

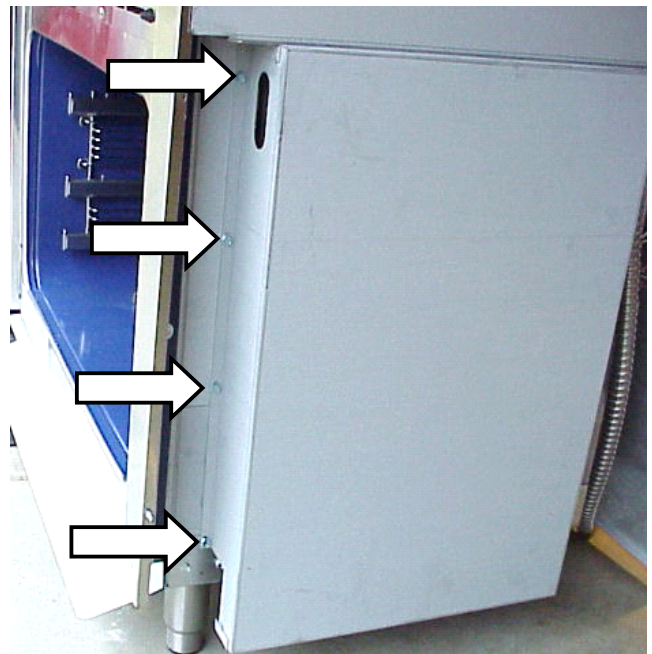

Removing the side fillers (36" model):

1. Disconnect power, remove the side panel and the manifold disconnect panel.

Removing the door rollers:

1. Remove the side panel, and on the 36 inch models remove the filler.
2. Remove the (3) screws holding the roller access panel to the side of the oven.

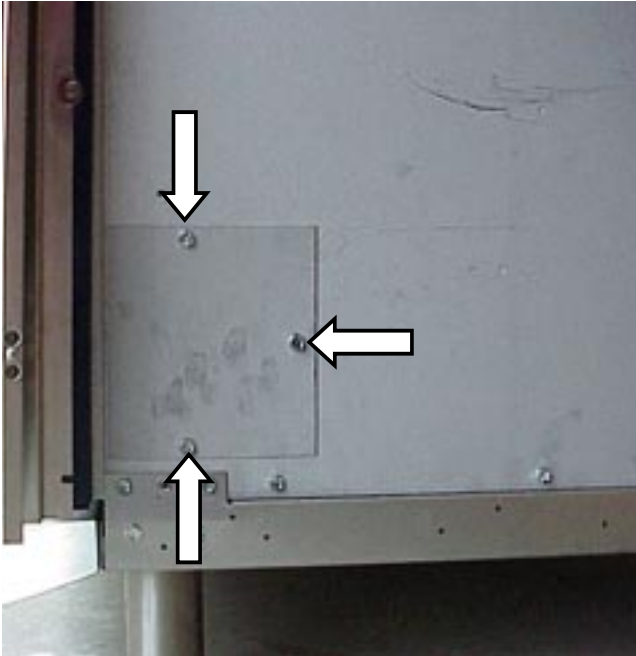

3. Using a 1/8" Allen wrench remove the (2) screws holding the roller assembly to the front frame of the oven and remove the roller assembly through the access panel.

