

GE Consumer & Industrial

Technical Service Guide

JULY 2008

Advantium 240

PSB2200NWW

PSB2200NBB

PSB2201NSS

ZSC2200NWW

ZSC2200NBB

ZSC2201NSS

ZSC2202NSS

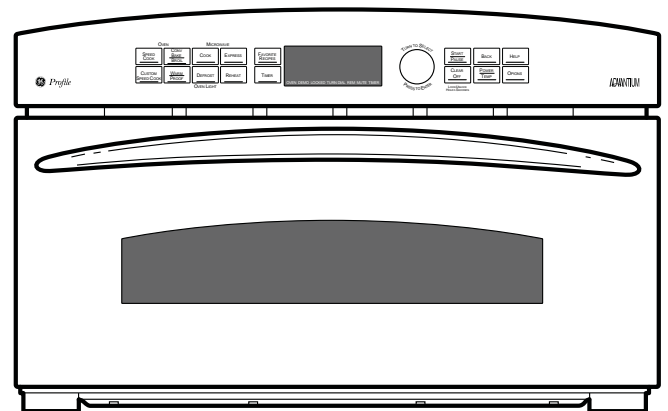

31-9173



GE Appliances
General Electric Company
Louisville, Kentucky 40225



IMPORTANT SAFETY NOTICE

The information in this service guide is intended for use by individuals possessing adequate backgrounds of electrical, electronic, and mechanical experience. Any attempt to repair a major appliance may result in personal injury and property damage. The manufacturer or seller cannot be responsible for the interpretation of this information, nor can it assume any liability in connection with its use.

WARNING

To avoid personal injury, disconnect power before servicing this product. If electrical power is required for diagnosis or test purposes, disconnect the power immediately after performing the necessary checks.

RECONNECT ALL GROUNDING DEVICES

If grounding wires, screws, straps, clips, nuts, or washers used to complete a path to ground are removed for service, they must be returned to their original position and properly fastened.

GE Consumer & Industrial

Technical Service Guide

Copyright © 2008

All rights reserved. This service guide may not be reproduced in whole or in part in any form without written permission from the General Electric Company.

PRECAUTIONS TO BE OBSERVED BEFORE AND DURING SERVICING TO AVOID POSSIBLE EXPOSURE TO EXCESSIVE MICROWAVE ENERGY.

- A. DO NOT OPERATE OR ALLOW THE OVEN TO BE OPERATED WITH THE DOOR OPEN.
- B. IF THE OVEN OPERATES WITH THE DOOR OPEN, INSTRUCT THE USER NOT TO OPERATE THE OVEN AND CONTACT THE MANUFACTURER IMMEDIATELY.
- C. MAKE THE FOLLOWING SAFETY CHECKS ON ALL OVENS TO BE SERVICED BEFORE ACTIVATING THE MAGNETRON OR OTHER MICROWAVE SOURCE, AND MAKE REPAIRS AS NECESSARY:
 - 1. INTERLOCK OPERATION.
 - 2. PROPER DOOR CLOSING.
 - 3. SEAL AND SEALING SURFACES (ARCING, WEAR AND OTHER DAMAGE).
 - 4. DAMAGE TO OR LOOSENING OF HINGES AND LATCHES.
 - 5. EVIDENCE OF DROPPING OR ABUSE.
- D. BEFORE TURNING ON MICROWAVE POWER FOR ANY TEST OR INSPECTION WITHIN THE MICROWAVE GENERATING COMPARTMENTS, CHECK THE MAGNETRON, WAVE GUIDE OR TRANSMISSION LINE AND CAVITY FOR PROPER ALIGNMENT, INTEGRITY AND CONNECTIONS.
- E. ANY DEFECTIVE OR MISADJUSTED COMPONENTS IN THE INTERLOCK MONITOR, DOOR SEAL AND MICROWAVE GENERATION AND TRANSMISSION SYSTEMS SHALL BE REPAIRED, REPLACED OR ADJUSTED BY PROCEDURE DESCRIBED IN THIS MANUAL BEFORE THE OVEN IS RELEASED TO THE OWNER.
- F. A MICROWAVE LEAKAGE CHECK TO VERIFY COMPLIANCE WITH THE FEDERAL PERFORMANCE STANDARD SHOULD BE PERFORMED ON EACH OVEN PRIOR TO RELEASE TO THE OWNER.

Table of Contents

Capacitor and Diode	33
Cavity Light.....	30
Circulation Blower Assembly.....	36
Component Access Chart	23
Component Locator Views.....	17
Components.....	23
Control Boards and Panel Connections	20
Control Features.....	8
Control Panel Assembly.....	26
Convection Heater Assembly and Thermistor	41
Damper Assembly.....	35
Demo Mode	15
Diagnostics and Service Information	47
Door Assembly.....	25
High Voltage Transformer	33
Humidity Sensor.....	43
Installation	16
Introduction.....	6
Left and Right Door Switch Assemblies.....	44
Lower Heater Assembly	40
Low Voltage Transformer	29
Magnetron and Magnetron TCO.....	34
Microwave Leak Test.....	48
Noise Filter	31
Noise Filter Fuse	31
Nomenclature	5
Oven Removal / Partial Removal.....	24
Proof Feature	14
Schematics and Wiring Diagrams	51
Sensor & Keypanel Failure Detection.....	48
Service Test Mode.....	49
Speed Cook System.....	10
Standard Test Load.....	48
Surge Filter	32
Surge Filter Fuses.....	32
Turntable Motor.....	43
Upper Heater Assembly	38
Upper Heaters, Convection, and Oven Cavity TCOs.....	37
Vent Motor Assembly.....	38
Warranty	53

Nomenclature

Model Number

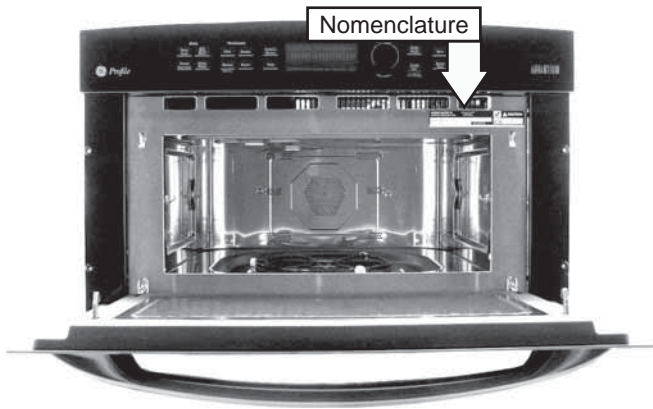
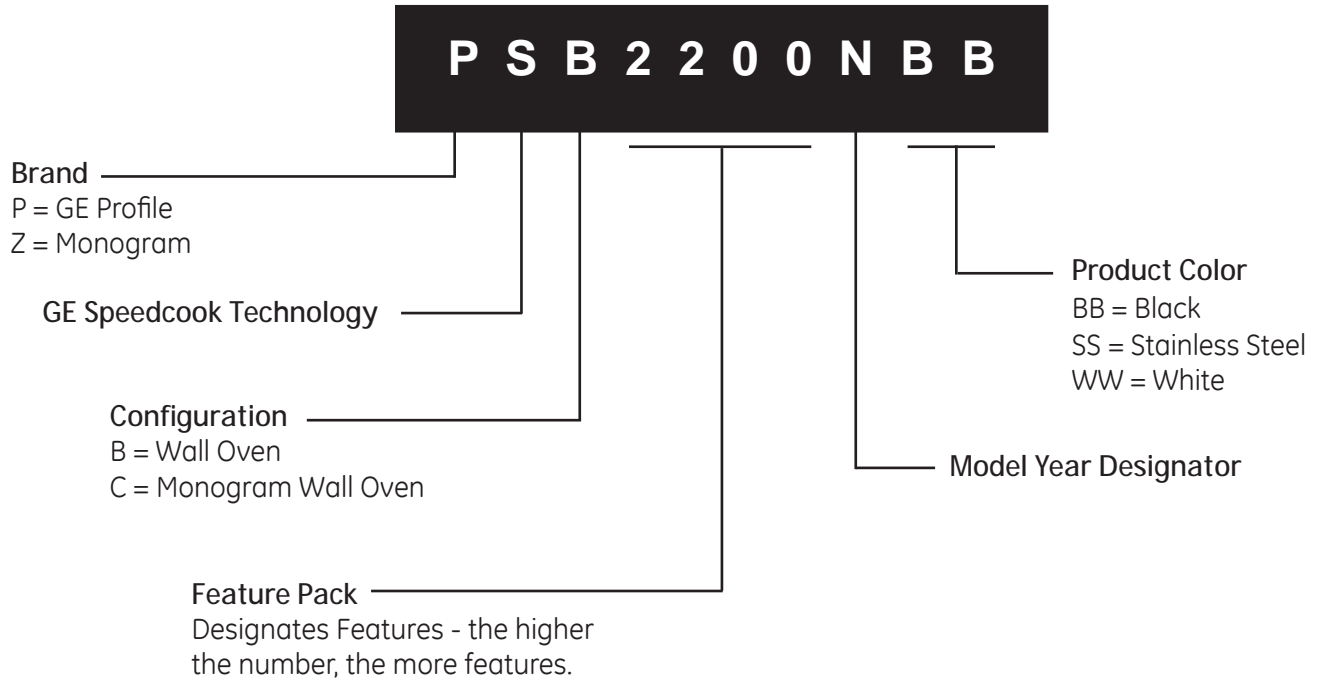

The nomenclature plate is located on the inside door frame.

The mini-manual is located behind the small access panel on the right side of the oven.

Serial Number

The first two characters of the serial number identify the month and year of manufacture.
Example: **AR**123456S = January, 2008

A - JAN	2008 - R
D - FEB	2007 - M
F - MAR	2006 - L
G - APR	2005 - H
H - MAY	2004 - G
L - JUN	2003 - F
M - JUL	2002 - D
R - AUG	2001 - A
S - SEP	2000 - Z
T - OCT	1999 - V
V - NOV	1998 - T
Z - DEC	1997 - S

The letter designating the year repeats every 12 years.

Example:

- T - 1974
- T - 1986
- T - 1998

Introduction

The new Advantium oven uses breakthrough Speedcook technology to harness the power of light. The Advantium oven cooks the outside of foods much like conventional radiant heat, while also penetrating the surface so the inside cooks simultaneously. While halogen light is the primary source of power, a convection system and ceramic heater assist in the cooking, with a "microwave boost" added in some cooking algorithms. Foods cook evenly and fast, retaining their natural moisture.

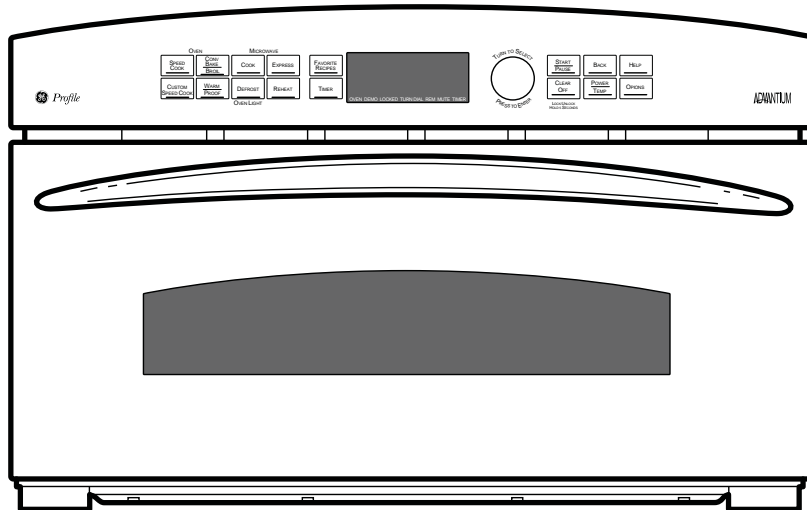

Features and Benefits

Speedcook Oven - Delivers oven quality food up to four times faster than a conventional oven. No preheating required.

True European Convection Oven - 1500-watt convection oven mode bakes and roasts at temperatures ranging from 250 to 450°F.

Sensor Microwave Oven - 950-watt sensor microwave oven mode automatically delivers perfect cooking results.

Warming Oven - Keeps prepared foods warm and fresh, and retains perfect moistness and crispness.

Proof Feature - Specialized mode allows dough to rise quickly.

16-in. Turntable - Removable metal and glass trays easily handle large casserole dishes.

Rounded Rear Wall - Allows complete turntable rotation of 9-in. x 13-in. casserole dish for even cooking.

Installation Flexibility - Fits either a 27-in. or 30-in. wall oven cabinet (installation kit included).

Preprogrammed Recipes - Provide quick and easy programming of over 175 Speedcook food selections.

Favorite Recipes - User can program up to 30 favorite recipes.

Multi-Level Cooking - Removable rack allows cooking of multiple dishes at once.

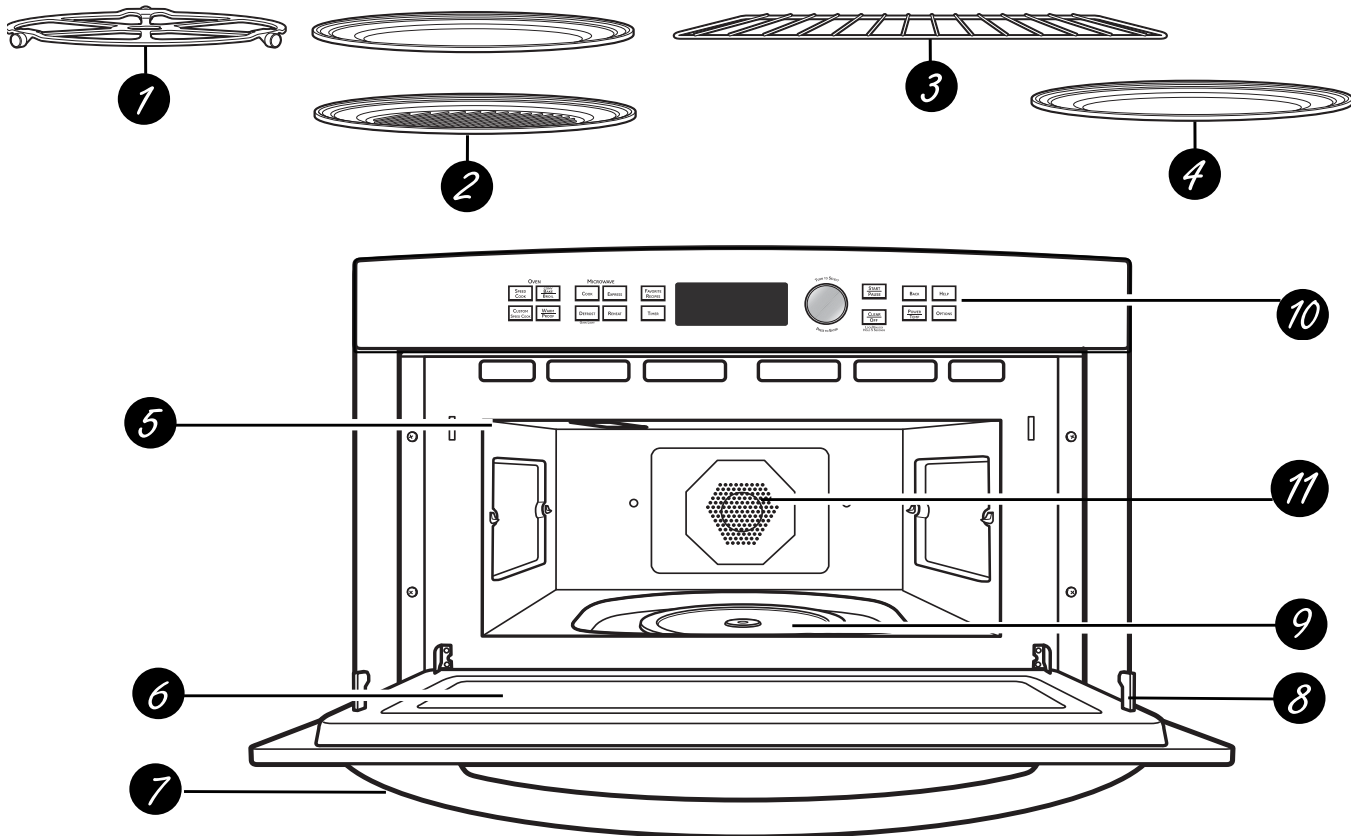

- 1** *Turntable*
The turntable must always be in place, on the oven floor, for all cooking. Be sure the turntable is seated securely over the spindle in the center of the oven with the marked side facing up.
- 2** *Metal Tray or Metal Grill Tray*
Put food directly on the metal tray or metal grill tray and place on the turntable when using the speedcook, broil, toast, warm and convection bake features.
- 3** *Wire Oven Rack*
Put food directly on the metal tray or in an oven-safe dish on the wire oven rack only when convection baking on two levels.
- 4** *Clear Glass Tray*
Place on turntable when using microwave features. Place food or microwave-safe cookware directly on tray.
- 5** *Upper Halogen Lamps*
Two 1200W halogen lamps cook food from above in speedcook, broil and toast.
- 6** *Window*
Allows cooking to be viewed while keeping microwaves confined in the oven.
- 7** *Door Handle*
Pull to open the door.
- 8** *Door Latches*
The door must be securely latched for the oven to operate.
- 9** *Lower Ceramic Heater*
One 500W ceramic heater cooks food from the bottom in speedcook, broil and toast.
- 10** *Control Panel*
The pads used to operate the oven are located on the control panel.
- 11** *Rear Convection System*
One 1500W heating element cooks food with a convection fan circulating the hot air throughout the cavity in speedcook, broil, convection bake, toast and warm.

Control Features

With your Advantium oven, you can cook with high-intensity halogen lights, ceramic heaters, convection heating element, and/or conventional microwave energy.

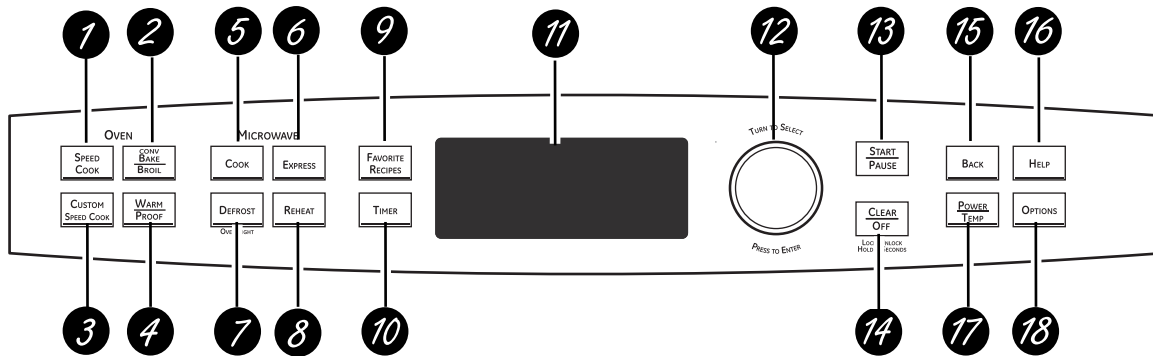

- 1 SPEEDCOOK/Repeat Last**
Press this pad to access the pre-set speedcook menu. Press and hold for 3 seconds to repeat the last cooking selection.
- 2 CONVECTION BAKE/BROIL**
Press this pad to convection bake, broil or toast.
- 3 CUSTOM SPEEDCOOK**
Press this pad to set your own speedcook program.
- 4 WARM/PROOF**
Select WARM to keep hot, cooked foods at serving temperature.
Select PROOF to create a warm environment useful for raising yeast-leavened products.
- 5 COOK (Microwave)**
Press this pad to microwave food.
- 6 EXPRESS (Microwave)**
Press for 30 seconds of microwave cooking time. Each time the pad is pressed an additional 30 seconds is added to the remaining cooking time. The oven starts immediately.
- 7 DEFROST (Microwave)/OVEN LIGHT**
Press this pad to defrost frozen foods, soften or melt. While cooking, press this pad to light the cavity for 4 seconds.
- 8 REHEAT (Microwave)**
Press this pad to reheat previously cooked foods, a plate of leftovers or beverages.
- 9 FAVORITE RECIPES**
Press this pad to add, edit (change) or remove a recipe from the memory.
- 10 TIMER**
Press this pad to set the minute timer.
- 11 Display**
Shows and instructs the use of all features on the oven.
- 12 SELECTOR DIAL—Turn to select, press to enter** First turn, then press the dial to make option, food, power level or temperature selections. Also use the dial to increase (turn clockwise) or decrease (turn counterclockwise) cooking times.
- 13 START/PAUSE**
Press this pad to start or pause any cooking function.
- 14 CLEAR/OFF**
Press this pad to cancel **ALL** oven programs except the control lock, clock and timer.
- 15 BACK**
Press this pad to step back one or more levels in the program process.
- 16 HELP**
Press this pad to find out more about your oven's features.
- 17 POWER/TEMP**
During cooking, press this pad and turn/press the selector dial to change the microwave power level, the convection bake temperature or the speedcook power levels.
- 18 OPTIONS**
Press this pad to set the *Clock* and access the *Beeper Volume*, *Auto Recipe Convert*, *Clock Display ON/OFF*, *Display Scroll Speed*, *Delay Start* and *Reminder* features.

(Continued Next Page)

Cooking Times

When Speedcooking preprogrammed foods, you may see **OPTIMIZING COOK TIME** in the display several seconds after you press **START/PAUSE**. The oven automatically senses the electrical voltage level in your home and adjusts the cooking time up or down for proper cooking.



Cooling Fans

The fans will be on during cooking. At the end of cooking, the fans may continue to run for a short time to cool internal components. The fans will automatically shut off when the internal parts of the oven have cooled. The oven vent will emit warm air while the oven is on.



Lights

When the oven is on, light may be visible around the door or outer case.

The halogen lights will dim and cycle on and off during a Speedcook cycle, sometimes even at full power levels. This is normal. The oven senses the heat level and adjusts automatically.

The oven cavity light will not come on during any cooking cycle but will come on whenever the door is opened. To view food while cooking, press the **DEFROST** pad, then the inner halogen heater will light the oven cavity for 4 seconds.

Oven Heat

No preheating time is required during Speedcook cycles. The oven begins cooking immediately.

The door and inside of the oven will be very hot. Use caution when opening the door and removing food. Be cautious of steam or vapor that may escape from around the door.

Do not use cookware or coverings made of paper, plastic, or foil when Speedcooking.

When cooking for an extended period of time, the oven may automatically reduce the power levels to maintain the appropriate level of oven heat.

Sounds

Clicks and a fan blowing are normal sounds during cooking. The electronic control is turning components on and off.

Interference

TV/radio interference might be noticed while using the microwave, similar to the interference caused by other small appliances. It does not indicate a problem with the microwave. Move the radio or TV as far away from the microwave as possible, or check the position of the TV/radio antenna.

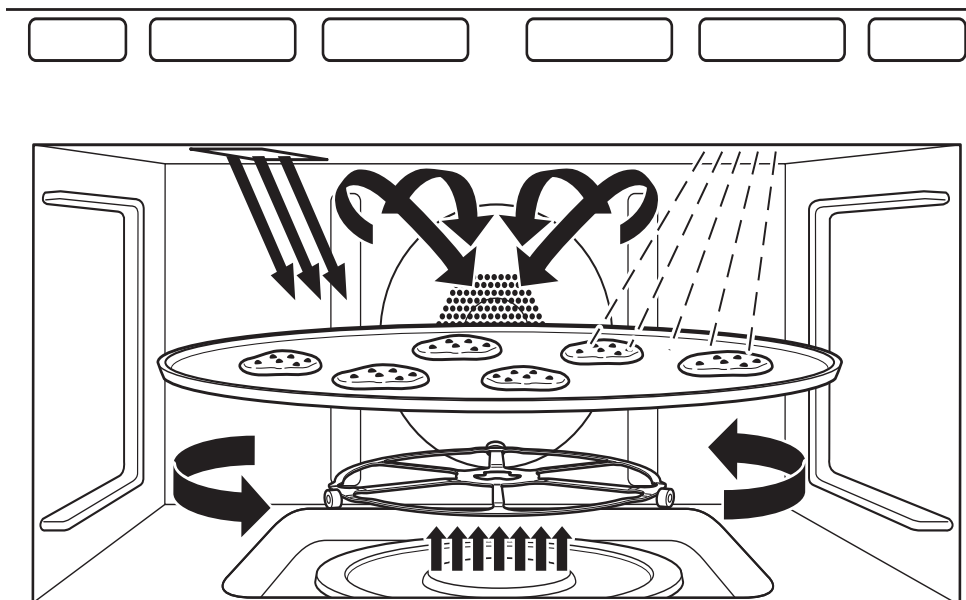

Halogen Lamp and Ceramic Heaters

- Two 1200-watt halogen bulbs cook food from above.
- One 500-watt ceramic heater cooks food from below.

Rear Convection Heat Element

- A 1500-watt convection element operates when using convection bake.
- The 1500-watt convection element is automatically added with certain foods.

Microwave

- A microwave “boost” is automatically added with certain foods.
- The oven can also be used as a 950-watt microwave oven.

Speedcook Overview

Upper Heaters

The upper heating assembly consists of two 1200-watt halogen heaters. The halogen heaters provide radiant heat, which browns the outside of the food while sealing in moisture and flavor. These heaters are operated by the control board based on power levels and duty cycle, and only operate in the Speedcook mode. However, during any cook mode the inner heater can be energized for 4 seconds by pushing the **DEFROST** pad on the control panel. This will illuminate the oven cavity long enough for the customer to see the contents inside the oven.

Lower Heater

The lower heater is a 500-watt ceramic heater. It operates in Speedcook, oven/bake, and warm modes. The lower heater assists in browning foods on the bottom.

Convection System

The 1500-watt convection system consists of a convection heater and fan that operate when using convection bake, broil, or toast, and assists in heating the oven when using Speedcook.

Microwave Energy

Caution: When cooking in Microwave mode, always use the glass tray.

The Advantium 240 provides 950 watts of microwave power, which is delivered directly into the oven cavity to work independently, or in conjunction with other cooking cycles. As the food rotates on the oven turntable, microwave energy is evenly distributed to all portions of the food.

Sensor Cooking

Advantium's microwave mode features sensor cooking, which automatically selects cook times and power levels. A humidity sensor detects the increasing humidity released during cooking, senses when the food is done, and shuts the oven off at the appropriate time. Sensor cooking is not available for 5 minutes immediately following Speedcook.

Power Levels

Advantium uses power from high-intensity halogen lamps, a ceramic heater, microwave energy, as well as convection heating to simultaneously cook foods evenly and quickly (average of one-fourth the time of a conventional oven) to seal in moisture and flavor.

Power levels are selected with the selector dial and can be adjusted before cooking or during cooking. When using preset menu foods, the power levels are already selected. However, power levels can be adjusted when cooking both preset menu food and when manual cooking.

Power levels from 0 to 10 can be selected and adjusted independently for the upper halogen lamps (pair), lower ceramic heater (single), microwave energy, and convection heating. When selecting an upper halogen lamp power level, the power level can only be selected for the pair. You cannot select power levels for the inner and outer independently.

The power levels control the percentage of ON time for the upper halogen lamp pair, the lower ceramic heater, and microwave high voltage circuit. During Speedcook, the operation of the convection heater is based on temperature. The convection heater will cycle on and off if needed, and the convection fan will operate continuously throughout Speedcook.

UPPER POWER (U) controls the upper halogen heaters. Select a higher setting for such foods as pizza and baked goods. Select a lower setting for foods, such as casseroles, meats, and fish.

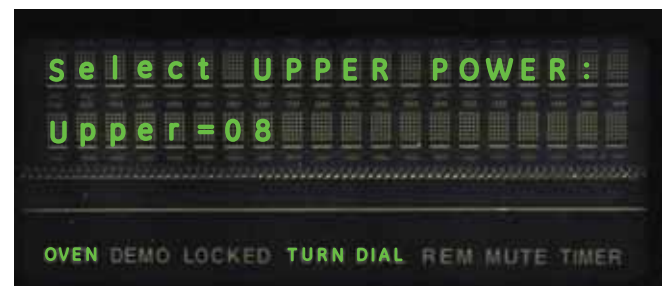

(Continued Next Page)

LOWER POWER (L) controls the lower ceramic heater. Select a higher setting for thick or dense foods that may not cook quickly in the center. Select a lower setting for thin foods, such as cookies.

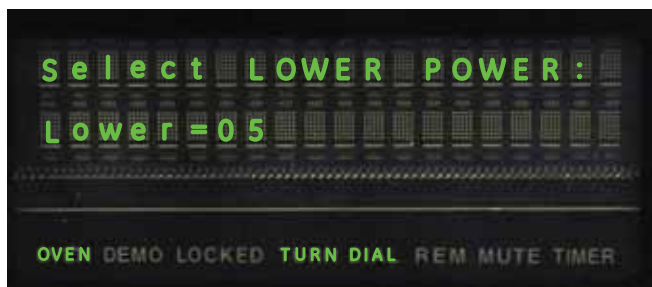

MICROWAVE (M) controls operation of the microwave. Select a higher setting to shorten cooking time for dense or heavy food, such as whole chicken. Select a lower setting for delicate foods, such as breads or foods requiring longer times.

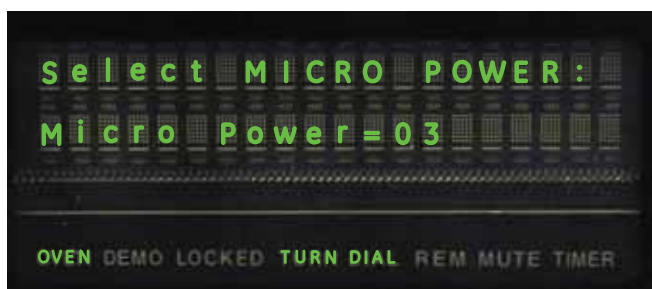

CONVECTION (C) controls the heat output of the convection system. Select a lower setting for more delicate foods that cook at lower temperatures. Select a higher setting (6 or above) for more robust foods that cook at temperatures above 350°F.

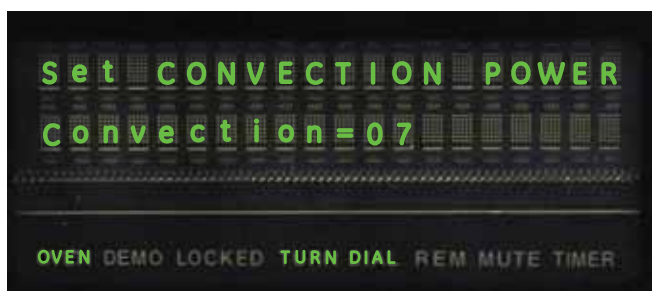

The display will show a summary of the power levels before cooking.

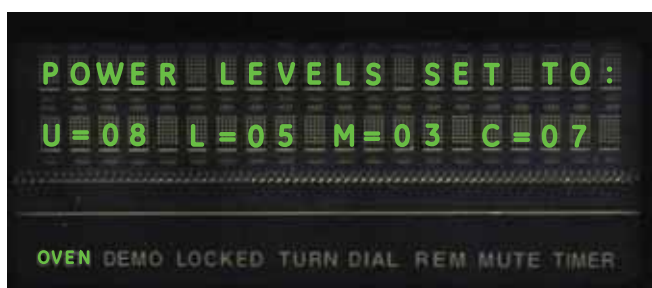

The programming on the smart board which controls the upper halogen lamps (pair) and the lower ceramic heater, as well as the high voltage/magnetron circuits, operates on a duty cycle of 32 seconds. This means the power level you select for each component controls the percentage of ON time during each 32-second period of time. For example, when the oven is set on power level 10, both the inner and outer halogen heaters will stay on 100% of the time. On power levels less than 10, both heaters will cycle together.

In the following example, the upper halogen lamps would cycle for 80% of each 32-second period, the lower ceramic heater would cycle at 50% of each 32-second period, and the microwave high voltage circuit would be energized for 30% of each 32-second period.

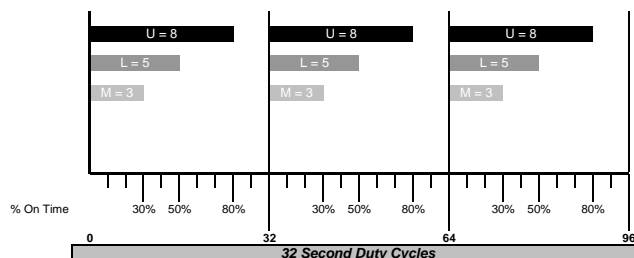

Each convection power level setting directs the convection cooking system to operate within certain parameters as shown in the table below.

Convection Cooking Chart		
Power Level	Temperature	Operation
0	Room	See Note 1
1	300°F	See Note 2
2	310°F	See Note 2
3	320°F	See Note 2
4	330°F	See Note 2
5	340°F	See Note 2
6	350°F	See Note 3
7	375°F	See Note 3
8	400°F	See Note 3
9	425°F	See Note 3
10	450°F	See Note 3

Notes:

1. Convection element not ON.
2. Reaches temperature and then cycles at temperature for remainder of programmed time.
3. Reaches temperature and then cycles at 350°F for remainder of programmed time.

(Continued Next Page)

Voltage Compensation

Note: Voltage compensation only occurs when using a preselected menu item in Speedcook. These items require compensation for accurate and consistent cooking results.

Voltage fluctuations in the power supply can cause inconsistencies in cooking. The main PCB measures line voltage at the start of each Speedcooking selection and adjusts the cooking time to achieve consistent results. Optimal line voltage, where no voltage compensation occurs, is 120 VAC. Above 120 VAC, time is subtracted from the recipe. Below 120 VAC, time is added to the recipe. The amount of voltage compensation required is dependent upon the incoming voltage at the start of the cooking cycle and the particular Speedcooking selection that is chosen.

The following chart shows the predicted compensation times based on a 5-minute Speedcook selection (*e.g.*, Biscuits, Refrigerated, Large).

Voltage Compensation Chart

Voltage	Time Change (Seconds)
108	+180
110	+150
112	+120
114	+90
116	+60
118	+30
120	0
122	-21
124	-42
126	-63
128	-84
130	-105
132	-126

Note: Voltage compensation should be within 20 seconds of values in table.

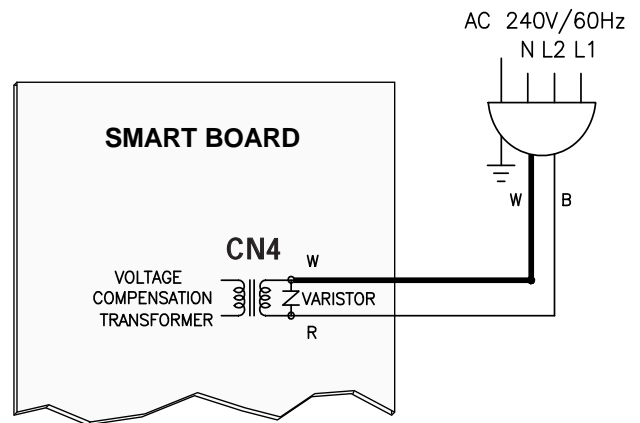

Voltage Compensation Circuit

Voltage compensation occurs after approximately 5 seconds of cooking operation. The display will show *OPTIMIZING COOK TIME*. The time will flash and then display the new adjusted time, based on the amount of voltage compensation required.

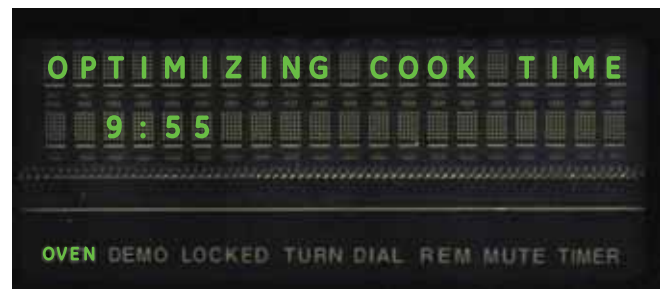

Voltage compensation only occurs during Speedcook operation and only occurs once during the cooking cycle (at initial start of Speedcook operation).

Thermal Compensation

Note: Thermal compensation only occurs once and only when using a preprogrammed menu item in Speedcook. These items require compensation for accurate and consistent cooking results.

When cooking several food items consecutively, the temperature in the oven may become very high. When Speedcooking, the Advantium automatically compensates for the increased temperature by reducing the power levels based on the following rules during each 32-second duty cycle.

Note

- Thermal Compensation occurs only ONCE and when using a pre-programmed recipe.
- Activates when oven cavity temp is greater than 220°F.
- Compensation rules:
UPL = Upper Power Level,
LPL = Lower Power Level,
CPL = Convection Power Level.
- No compensation if cook time is less than 2 minutes 30 seconds or greater than 13 minutes.
- If cavity temp less than 220°F, no compensation.
- If cavity temp greater than 220°F but less than 288°F, reduce UPL by 1, LPL by 2, and CPL by 2.
- If cavity temp greater than 288°F but less than 340°F, reduce UPL by 1, LPL by 3, and CPL by 2.
- If cavity temp greater than 340°F, reduce UPL by 1, LPL by 3, and CPL by 3.
- Upper thermal sensor (blue and white wires) is used for thermal compensation.

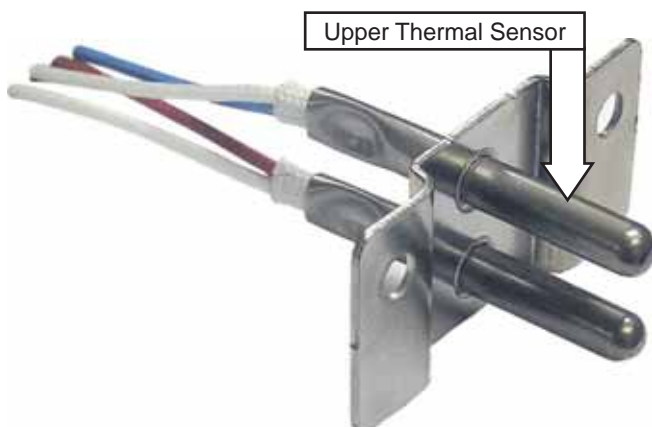

Proof Feature

The purpose of the PROOF feature is to help dough rise at the correct temperature inside the oven. To activate the proof feature, press the **WARM/PROOF** pad, then turn the dial to **PROOF BREAD** and press the dial to start. The following will occur:

- The convection fan and convection heater come on immediately.
- The convection element cycles 11 seconds on and 21 seconds off for first 30 minutes at temperature around 80°F, then after 30 minutes element is 100% on only if the temperature is below 80°F and cavity is calling for heat.
- The convection fan continues to operate and, if needed, the convection heater will come on.

Note: In PROOF, there is not an upper temperature set point defined. If the temperature is above 80°F, then the element does not come on at all until the temperature is below 80°F. (Ideally you don't want a temperature over 100 - 110°F because you will kill the yeast.) But unless there is something wrong with the oven control, the element, or the actual environment is above 100°F, PROOF should never reach this condition. If an inoperative convection heater in the PROOF mode is suspected:

1. Disconnect power.
2. Remove the rear access cover.
3. Remove the thermistor from the convection heater assembly.
4. Lower the thermistor temperature by placing a chilled or frozen item against the thermistor.
5. Connect power and enter proof mode.
6. Check for approximately 120 VAC (12.3 Amps) at the convection heater.

Demo Mode

The sales demo mode will allow dealers to demonstrate all oven functionality with one exception. (See #1 below.)

The sales demo mode can only be entered during the initial *SELECT TIME* display that occurs when the unit powers up after a long (greater than 60 seconds) power outage.

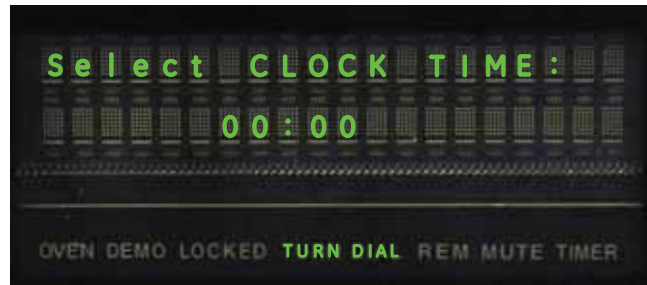

The sales demo mode will be initiated by holding the *POWER / TEMP* and *START / PAUSE* pads down at the same time for a full 3 seconds.

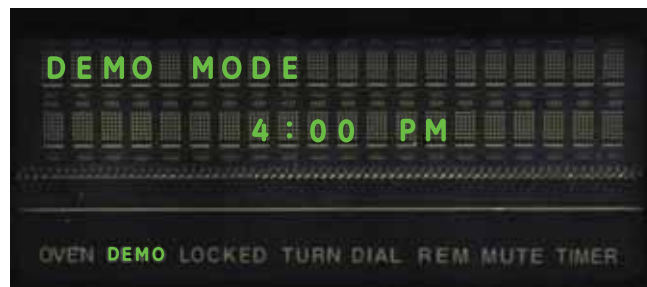

When sales demo mode is initiated, 2 short-beeps are sounded and all oven functions will operate with the following exceptions;

1. No power shall ever be applied to the heaters, halogen lamps, magnetron high voltage transformer, or Inrush control relays. The control relays for any of these loads shall not be switched during sales mode. However, if you press the *DEFROST* pad while in a demo cook mode, the inner halogen light will come on for 4 seconds.
2. The *DEMO* icon will be lit whenever the unit is in sales mode regardless of settings or the feature being selected.

The sales demo mode is cleared by holding the *POWER / TEMP* and *START* pads down at same time for a full 3 seconds. The sales mode can **only** be cleared during the same initial *SELECT TIME* display that occurs when the unit powers up after a long (greater than 60 seconds) power outage. After 5 seconds elapse, all functions of the oven will return to normal operation.

When power-up occurs, software will check the special sales demo identifier code. If the code is set, then the oven will stay in the sales demo mode. This will prevent the unit from powering back up to a normal mode if power to the salesroom had gone off.

Installation

Advance Planning

- These ovens may be installed directly into a 30" wide oven cabinet.
- Cutout dimensions are NOT the same for installation with or without an accessory storage drawer. Make sure to use the correct cutout when preparing the opening.

Note: Model ZSC2202 CANNOT be installed with an accessory storage drawer. Refer to Installation Instructions, Pub. 49-40574-1.

IMPORTANT— This oven is not approved for use above another built-in Advantium Speedcook oven, a side by side installation or below a countertop.

- For personal safety, this oven cannot be installed in a cabinet arrangement such as an island or peninsula.
- The oven must be installed at least 36-3/4" above the floor.
- Allow for clearance to adjacent corners, walls, drawers, etc.
- Cabinets installed adjacent to wall ovens must have an adhesion spec of at least 194°F temperature rating.
- The oven must be securely installed in a cabinet that is firmly attached to the house structure. Weight on the oven door could cause the oven to tip and result in injury. Never allow anyone to climb, sit, stand or hang on the oven door.
- If installing the drawer accessory, the drawer must be assembled to the oven prior to installation into the cabinet. Refer to Installation Instructions, Pub. 49-40574-1.

Electrical Requirements

Single Speedcook Installation

Product rating is 120/208 or 120/240 volt, 60 Hz, 30 amps. This product must be connected to a supply circuit of the proper voltage and frequency and protected by a time delay fuse or circuit breaker. Power should be supplied from a separate, dedicated 30-ampere branch circuit.

Wire size must conform to the requirements of the National Electrical Code or the prevailing local code.

Combined Speedcook and Wall Oven Installation

When installed in combination with a GE/Monogram single wall oven, use separate electrical junction boxes.

Refer to single oven installation instructions for electrical requirements of that product.

These connections must be made by a qualified electrician. All electrical connections must meet National Electrical Code or prevailing local codes.

Combined Speedcook and Warming Drawer Installation

When installing the Speedcook oven over a GE or Monogram electric warming drawer, a separate 120V, 60Hz, properly grounded receptacle must be installed. See instructions packed with the warming drawer.

WARNING

- The electrical power to the oven branch circuit must be shut off while line connections are being made.
- Use copper wiring only.
- Electrical ground is required on this appliance. The free end of the green wire (ground wire) must be connected to a suitable ground. This wire must remain grounded to the oven.
- If cold water pipe is interrupted by plastic, non-metallic gaskets, union connections or other insulating materials, DO NOT use for grounding.
- DO NOT ground to a gas pipe.
- DO NOT have a fuse in the NEUTRAL or ROUNDING circuit. A fuse in the NEUTRAL or ROUNDING circuit could result in an electrical shock.
- Check with a qualified electrician if you are in doubt as to whether the appliance is properly grounded.

Failure to follow these instructions could result in serious injury or death.

Component Locator Views

Front View

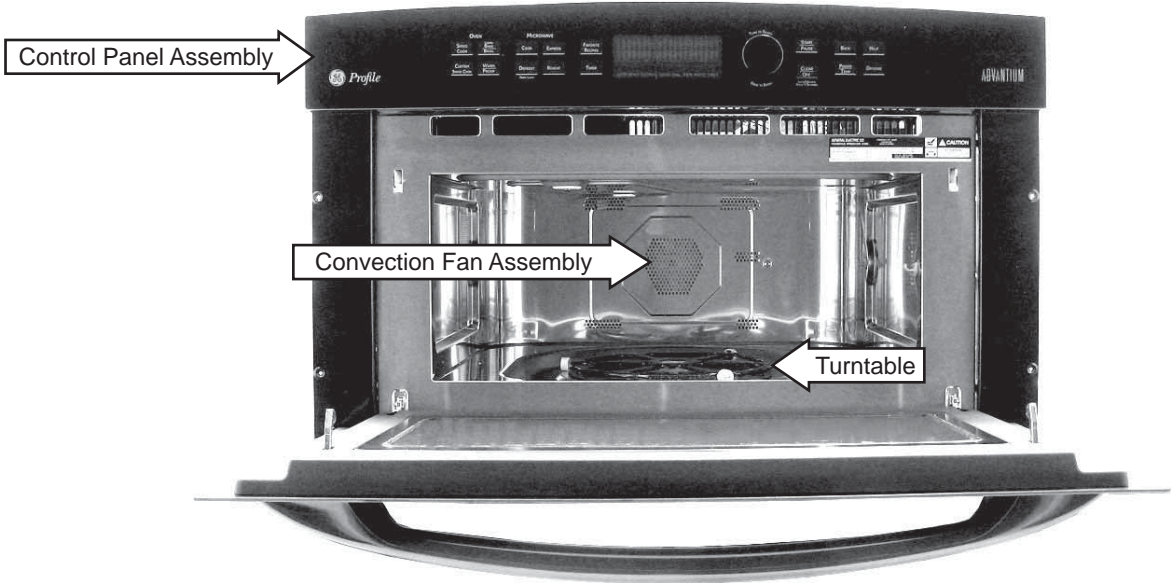

Top View

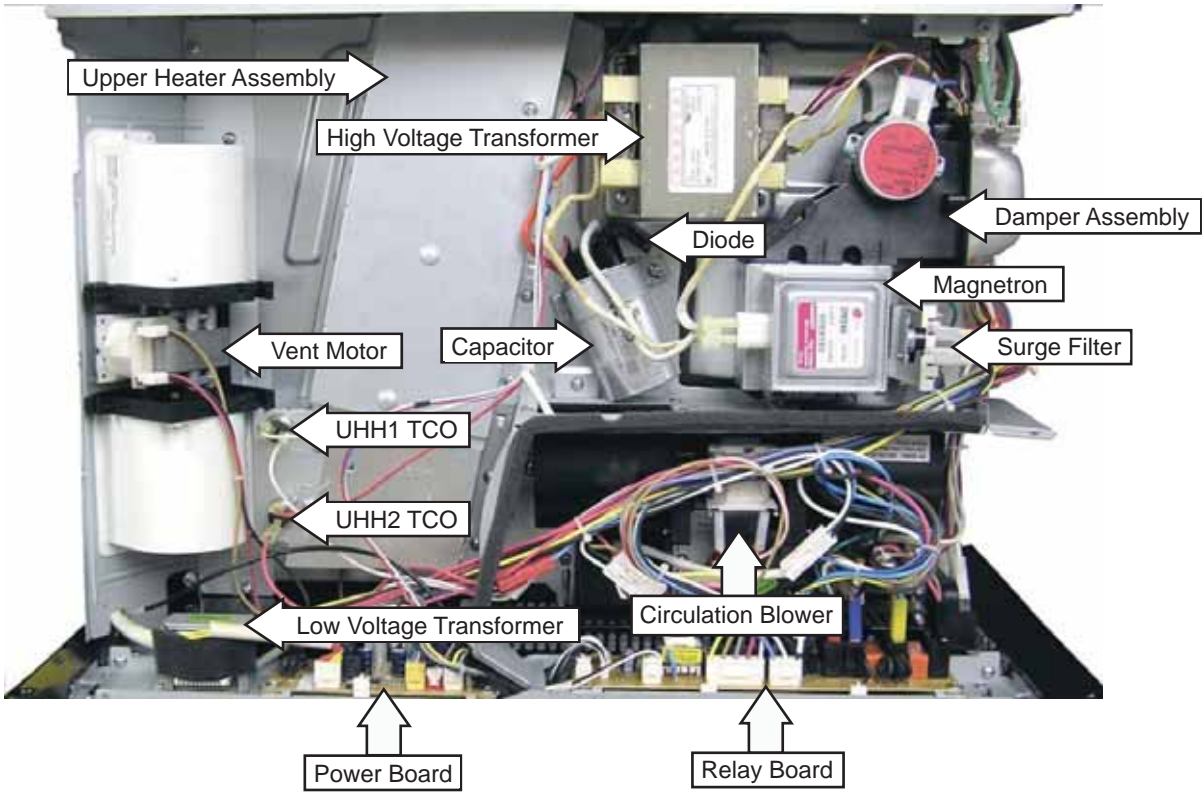

Bottom View

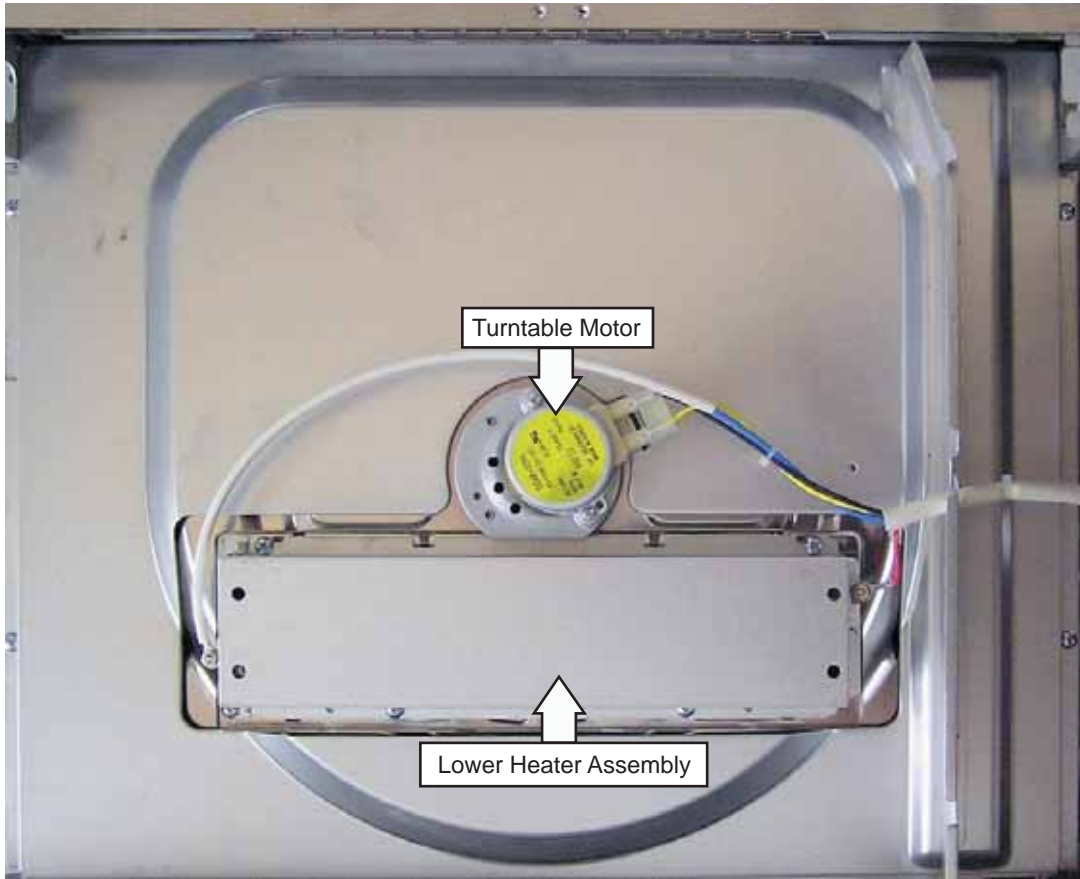

Left Side View

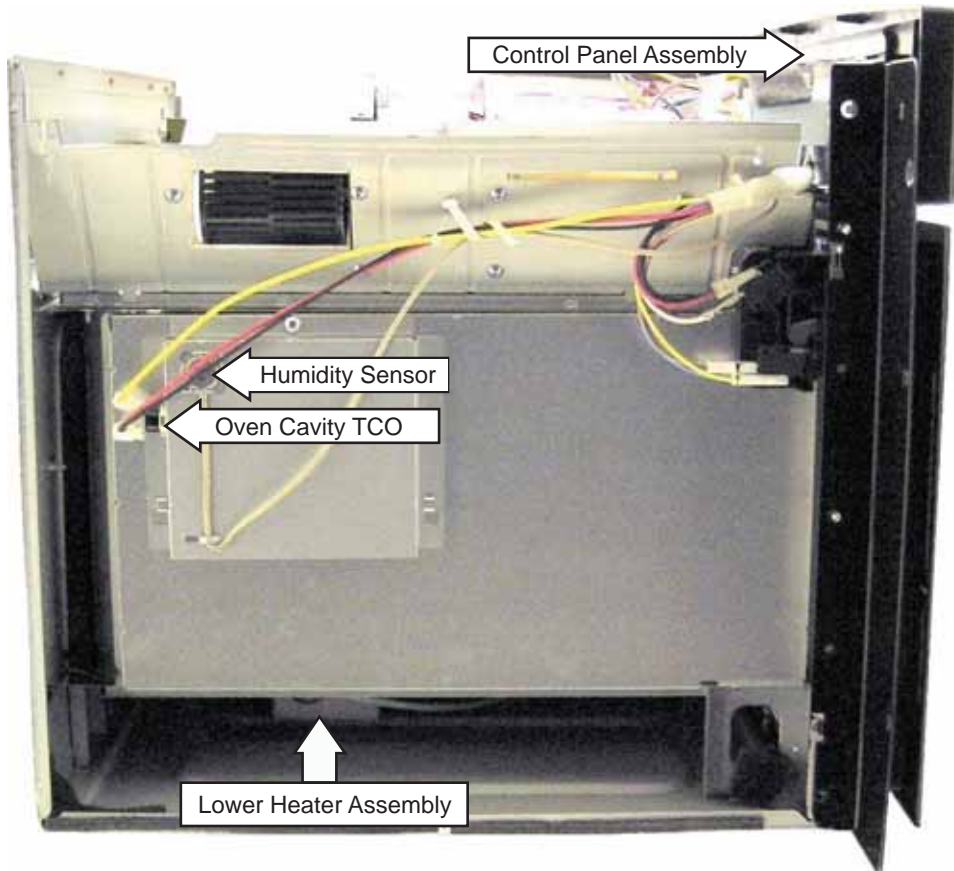

Right Side View

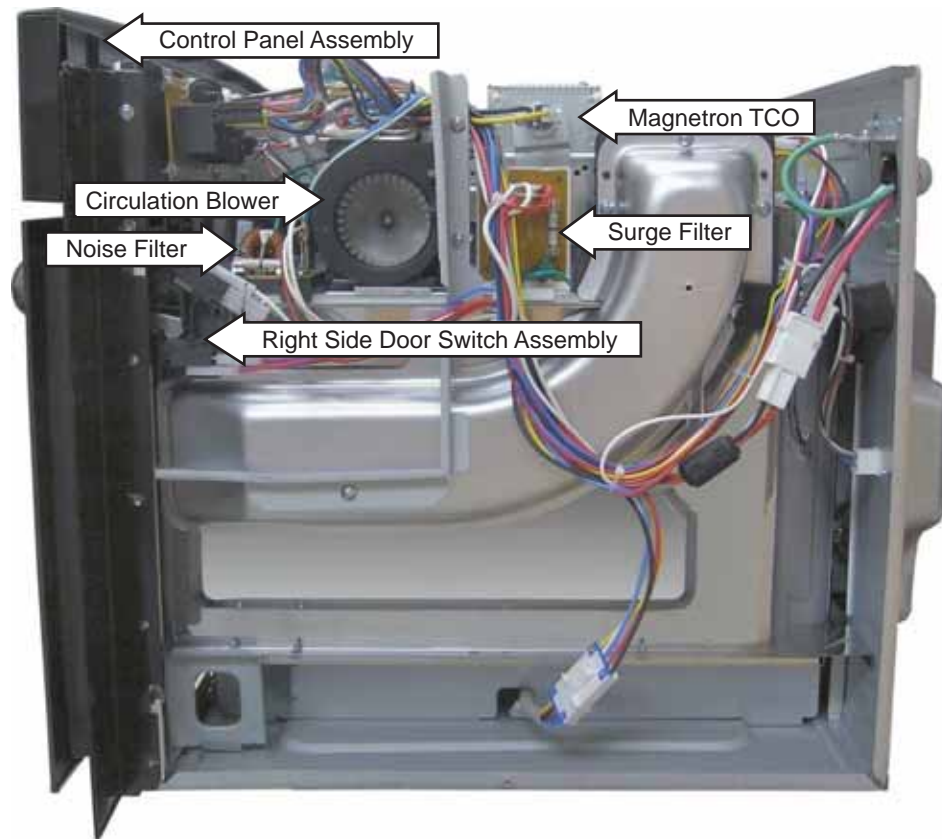

Control Panel Assembly (Shown separated)

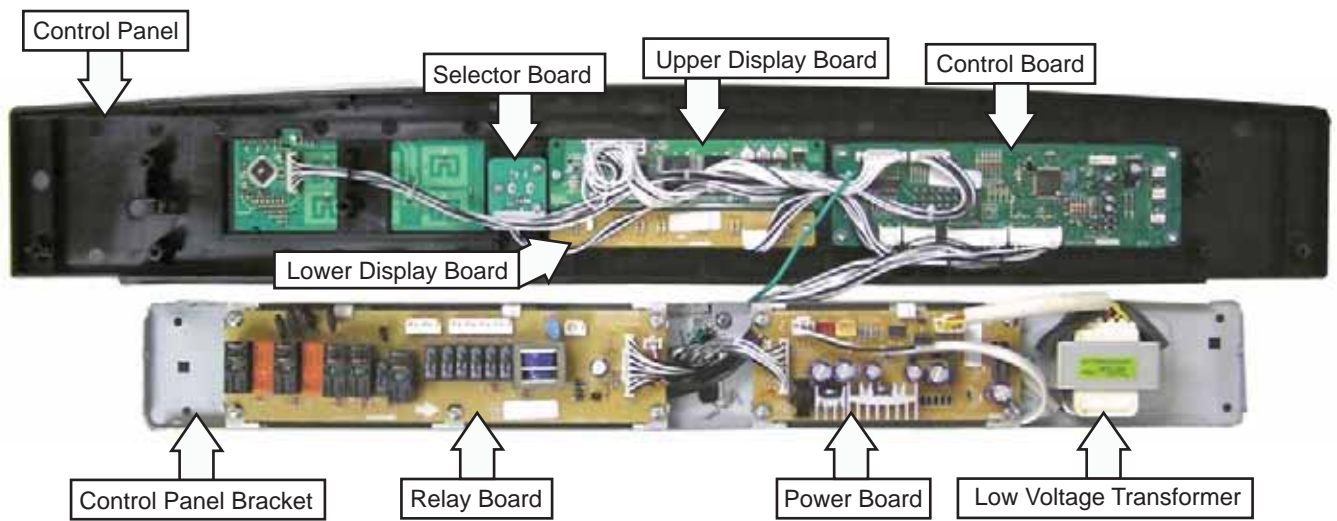

Control Boards and Panel Connections

Power Board

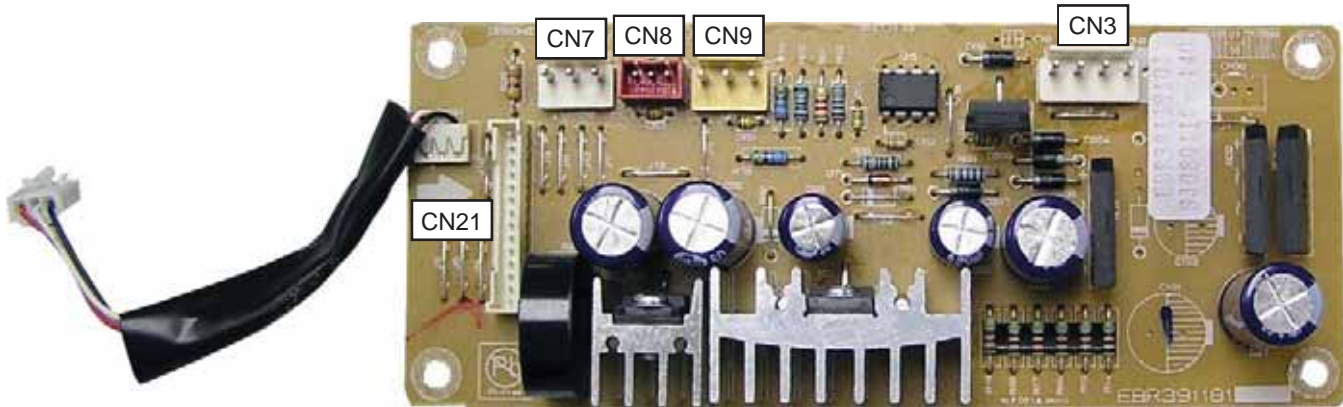

- CN3 - Low Voltage Transformer #1 (Secondary Windings)
- CN7 - Door Switch, Damper Switch
- CN8 - Humidity Sensor
- CN9 - Thermistor
- CN21 - Control Board

Relay Board

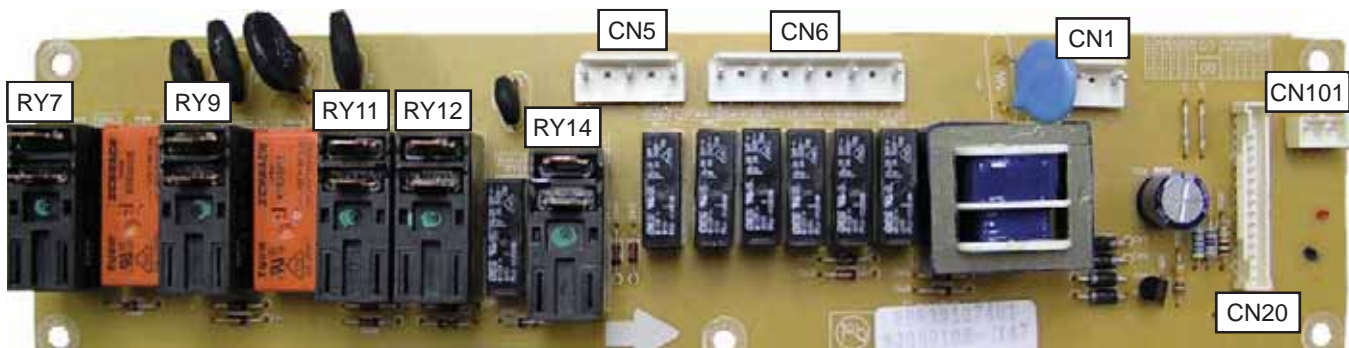

- RY7 - Inner Halogen Heater
- RY9 - Outer Halogen Heater
- RY11 - Ceramic Heater
- RY12 - Convection Heater
- RY14 - Magnetron
- CN1 - Low Voltage Transformer #1 (Primary Winding)
- CN5 - Primary Interlock, Noise Filter, Oven Lamp
- CN6 - Circulation Motor, Damper Motor, Convection Motor, Vent Motor, Turntable Motor
- CN20 - Control Board
- CN101 - Power Board

Control Board

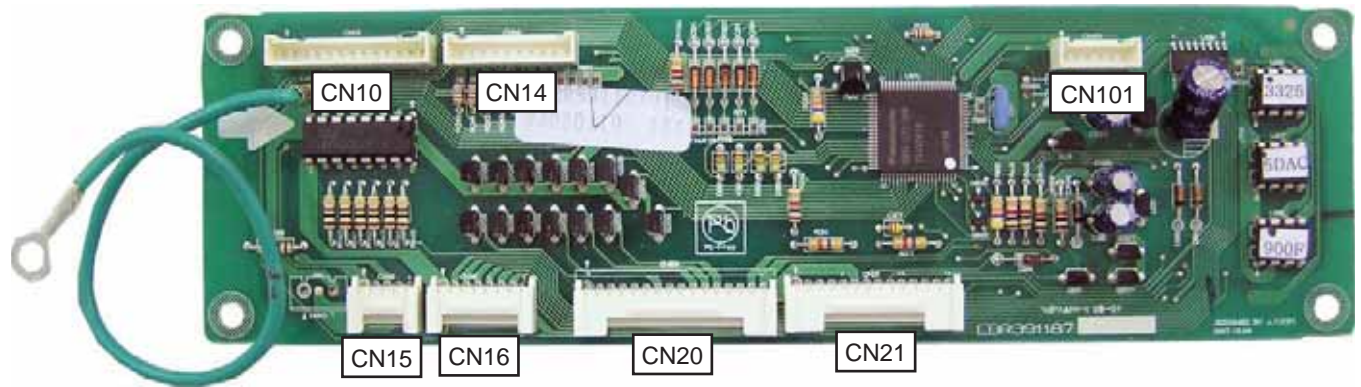

CN10 - Upper Display Board

CN14 - Control Panel

CN15 - Selector Board

CN16 - Lower Display Board

CN20 - Relay Board

CN21 - Power Board

CN101 - Not Used

Upper Display Board



Lower Display Board



(Continued next page)

Selector Board

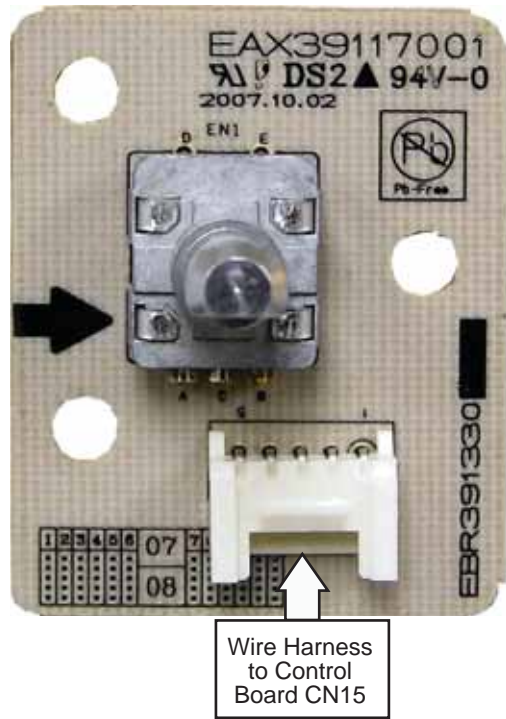

Control Panel



Components

Component Access Chart

WARNING:

- The oven is heavy and requires two people to remove from the cabinet or wall opening. Care should be taken when removing and installing.
- Sharp edges may be exposed when servicing. Use caution to avoid injury. Wear Kevlar gloves or equivalent protection.

	Serviceability - Unit Installed	Serviceability - Unit Partially Removed	Serviceability - Unit Removed
Circulation Blower Assembly			●
Capacitor and Diode			●
Cavity Light			●
Cavity TCO			●
Control Panel Assembly		●	
Convection Fan Motor			●
Convection Heater Assembly and TCO			●
Damper Assembly			●
Door Assembly	●		
Fuse (Noise Filter)		●	
Fuses (Surge Filter)			●
High Voltage Transformer			●
Humidity Sensor			●
Left and Right Door Switch Assemblies		●	
Lower Heater Assembly			●
Low Voltage Transformer		●	
Magnetron and Magnetron TCO			●
Noise Filter			●
Surge Filter			●
Thermistors (Thermal Sensors)			●
Turntable Motor			●
Turntable Support	●		
Upper Heater Assembly			●
Upper Heater TCOs			●
Vent Motor Assembly			●

Oven Removal / Partial Removal

To remove the oven from cabinet or wall opening:

WARNING: This oven requires 2 people for complete oven removal. Grasp the bottom of the oven at the front and rear on each side.

Caution: Do not use the oven handle to lift or lower the oven. Damage will occur.

1. Disconnect power from the oven.
2. Open the door and remove the wire rack, aluminum baking sheet, glass tray, metal tray, and turntable.
3. Remove 4 screws from the side trims.

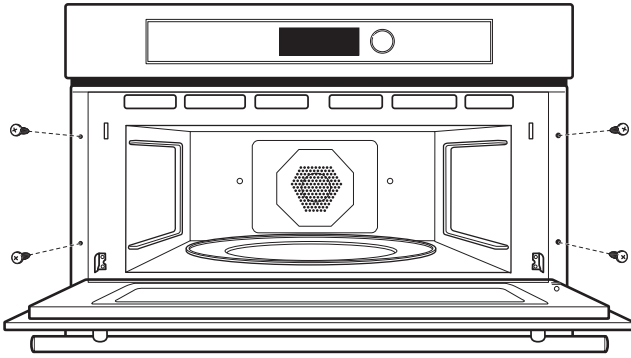

4. If the oven utilizes an accessory drawer, remove the 4 screws from the drawer side flanges.

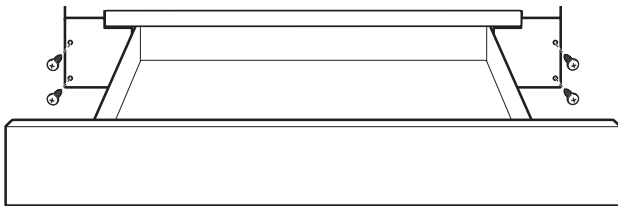

5. Slide the oven forward approximately 11 inches to access certain components.

Note: In the following step, the bottom trim is not used if the Advantium oven is installed with an accessory storage drawer.

6. Remove the 3 brass screws from the bottom of the trim.

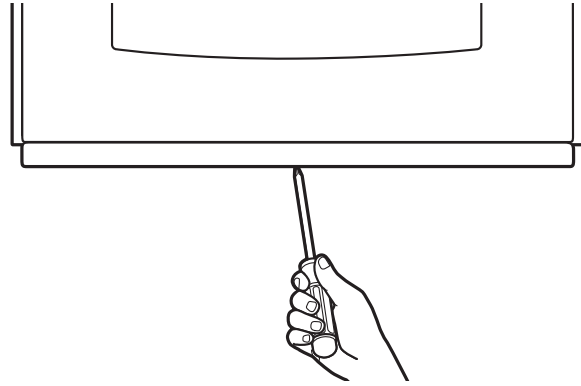

7. Disengage the tabs on the trim from the bottom of the oven.

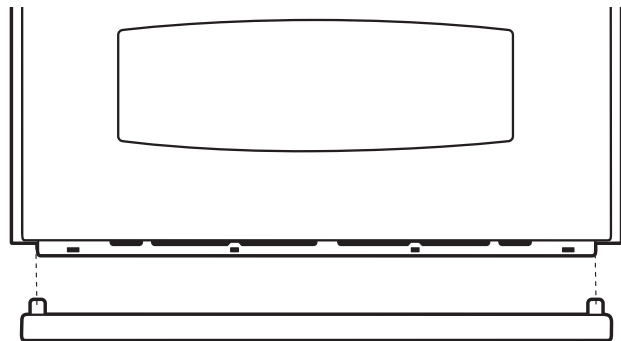

8. Carefully remove the oven completely from the cabinet or wall opening.

9. Disconnect oven wiring from junction box and lower the oven onto a protected surface.

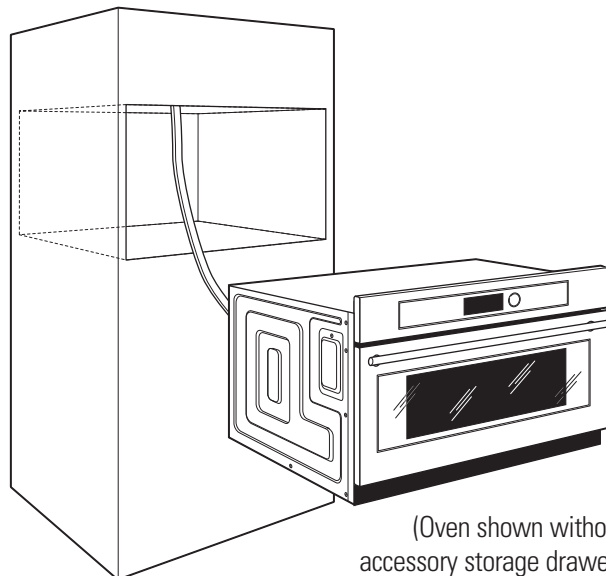

(Oven shown without accessory storage drawer.)

Access Cover

To remove the access cover, the oven must be removed from the installation.

The access cover is attached to the outer cover by 2 Phillips-head screws.



Outer Cover

To remove the outer cover, the oven must be removed from the installation.

The outer cover is held in place by 22 Phillips-head screws.



Door Assembly

WARNING: A microwave leakage test must be performed any time a door is removed, replaced, or adjusted for any reason. (See *Diagnostic and Service Information*.)

Door Removal

Caution: Do not close the door beyond the door removal position. Damage to the inner door panel will occur.

To remove the door, open the door fully and insert a door removal tool (Part # WB01X10364) in each door hinge opening. The door can then be slowly closed a few inches to the door-removal position and lifted from the oven.



Door-Removal Position



Control Panel Assembly

The control panel assembly consists of an outer control panel and an inner control panel bracket. The outer control panel contains the control, display, and selector circuit boards. The power and relay circuit boards, and the low voltage transformer are attached to the control panel bracket.

The control panel is held in place with 7 Phillips-head screws and 4 tabs. Two of the screws are recessed from the top of the outer cover. Access holes are provided. A magnetic screwdriver is necessary to capture these screws.

To remove the control panel assembly:

1. Place the oven in a partially removed position. (See *Oven Removal / Partial Removal*.)
2. Remove the 3 Phillips-head screws from the top front of the outer cover.



3. Remove the 2 recessed Phillips-head screws that attach the control panel assembly to the top of the frame.



4. Remove the 2 Phillips-head screws that attach the control panel assembly to the side of the frame.



5. Open the oven door.
6. Grasp the bottom of the control panel assembly and lift to release the 2 tabs that hold the bottom of the control panel assembly to the oven frame.
7. Disconnect wire harnesses from the power board at locations CN5, CN6, CN7, CN8, and CN9. (See *Control Boards and Panel Connections*.)
8. Disconnect wire harnesses from the relay board at locations RY7, RY9, RY11, RY12, and CN14. (See *Control Boards and Panel Connections*.)

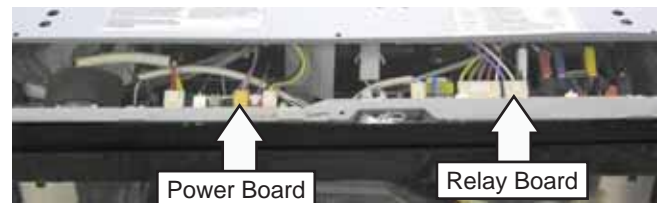

To remove the power board:

1. Remove the control panel assembly. (See *Control Panel Assembly*.)
2. Disconnect wire harnesses from the power board at locations CN3 and CN21.
3. Peel back the foam tape and disconnect wire harness CN101 from the relay board.
4. Remove the 4 Phillips-head screws that attach the power board to the control panel bracket.
5. Lift the power board to clear the retaining tab.

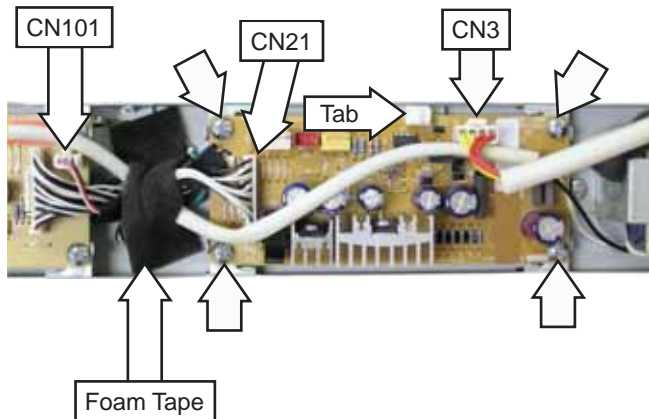

To remove the relay board:

1. Remove the control panel. (See *Control Panel Assembly*.)
2. Disconnect the wire harness from the relay board at locations CN1, CN20, and CN101.
3. Remove the 5 Phillips-head screws that attach the relay board to the control panel bracket.
4. Lift the relay board to clear the 2 retaining tabs.

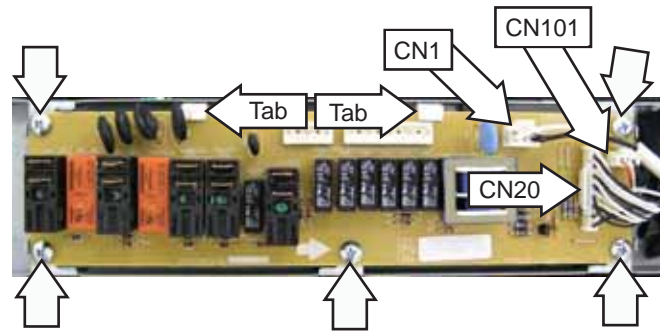

To remove the control panel bracket:

1. Remove the control panel. (See *Control Panel Assembly*.)
2. Disconnect wire harnesses from the relay board at location CN20 and from the power board at location CN21.
3. Remove the foam tape and the Phillips-head screw that attaches the ground wire to the bracket.

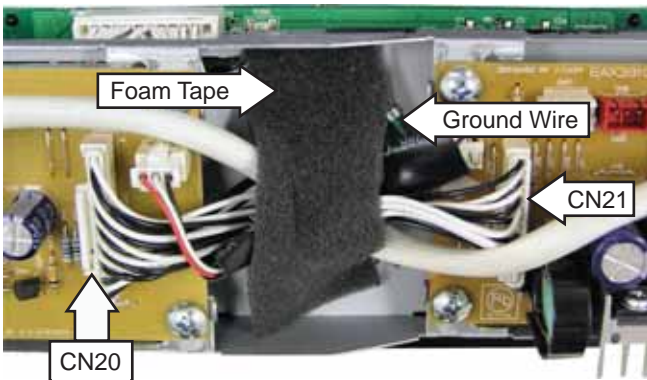

4. Remove the 4 Phillips-head screws (2 on each side) from the control panel bracket.
5. Slide the control panel bracket to the right then lift the control panel bracket from the control panel.
6. Guide the disconnected harnesses and the ground wire through the wire entry hole in the control panel bracket.

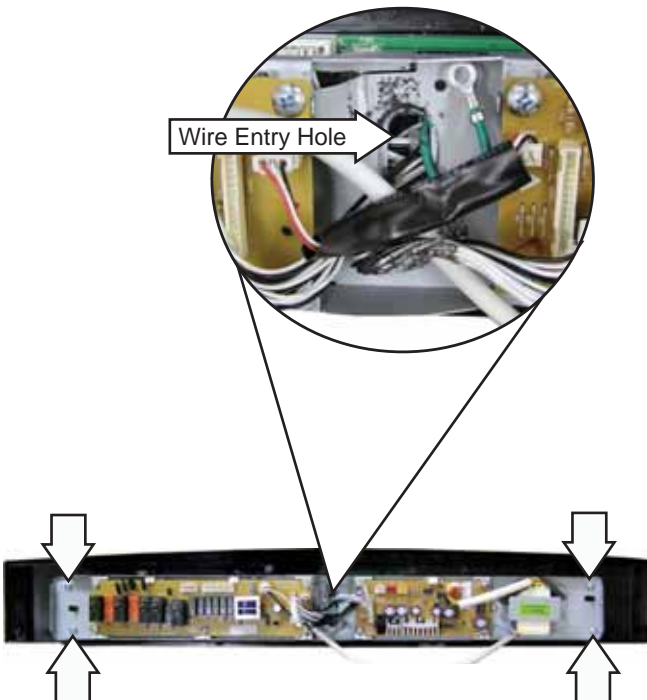

To remove the control board:

1. Remove the control panel bracket. (See *Control Panel Assembly*.)
2. Disconnect the 20-pin harness connector from the display board.
3. Disconnect the wire harnesses from the selector board at locations CN10, CN14, CN15, CN16, CN20, and CN21.
4. Remove the 4 Phillips-head screws that hold the control board to the control panel.

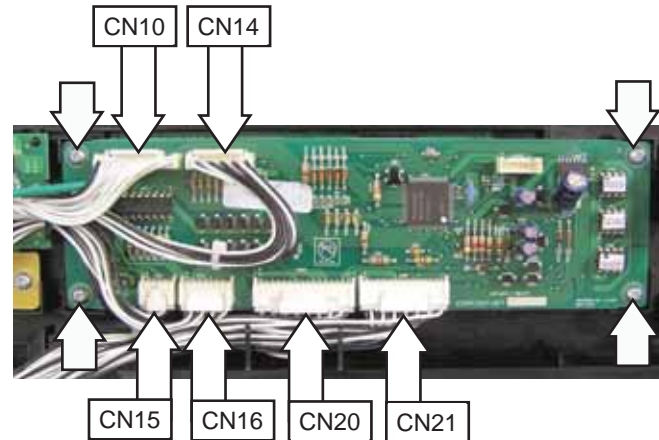

To remove the upper display board:

The upper display board is attached to the control panel by 2 Phillips-head screws and positioned by 2 pins. The wire harness located at CN1 connects the upper display board to the control board. To access the upper display board it is necessary to remove the control panel bracket. (See *Control Panel Assembly*.)

To remove the lower display board:

The lower display board is attached to the control panel by 2 Phillips-head screws. The single wire harness connects the lower display board to the control board. To access the lower display board it is necessary to remove the control panel bracket. (See *Control Panel Assembly*.)

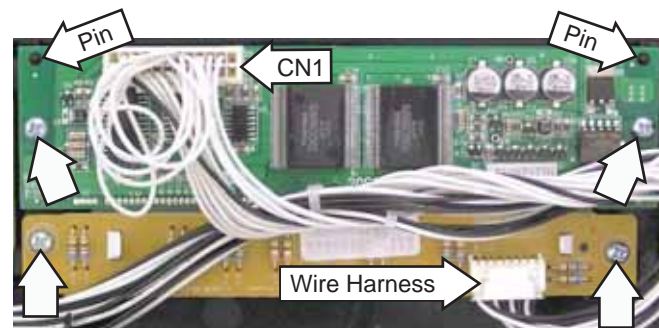

To remove the selector board:

1. Remove the control panel bracket. (See *Control Panel Assembly*.)
2. Pull the dial straight out from the control panel.
3. Remove the 3 Phillips-head screws that attach the board to the control panel.

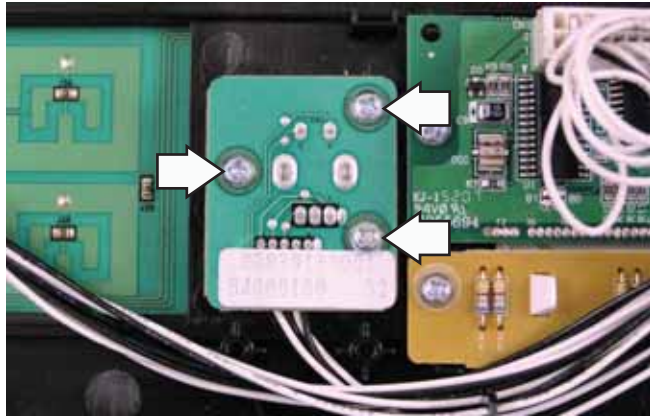

4. Disconnect wire harness from the selector board.

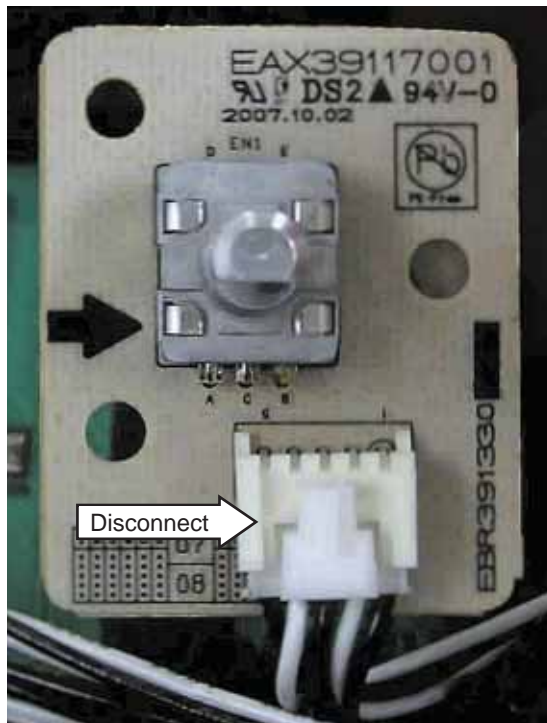

To remove the control panel:

To access the control panel it is necessary to remove the control panel bracket, control, display, and selector boards. (See *Control Panel Assembly*.)



Low Voltage Transformer

The low voltage transformer converts 120 VAC to 2 low voltage AC outputs that supply the control boards with proper operating voltages.

The low voltage transformer is held in place by 2 Phillips-head screws.

The control panel must be removed to access the low voltage transformer. (See *Control Panel Assembly*.)

The low voltage transformer is connected to the power board at location CN3 and on the relay board at location CN1.



Resistance Check

1. Disconnect the harness from the relay board at location CN1.
2. Check the primary winding for approximate resistance value between the white and black wires of 23.2 Ω .
3. Disconnect the harness from the power board at location CN3.
4. Check the secondary windings for approximate resistance value between:
 - Yellow to yellow - 1.8 Ω
 - Red to red - 1.2 Ω

Note: Voltage check for the transformer is:

- Yellow to yellow - 18 VAC
- Red to red - 7 VAC

Cavity Light

The oven lamp is attached to the inside of the cavity light housing with 2 Phillips-head screws. The light housing is attached to the oven with 2 Phillips-head screws. A single wire harness is connected to the oven lamp. It is necessary to remove the outer cover to access the oven lamp. (See *Oven Removal / Partial Removal*.)

The oven cavity light will only come on when the door is opened.

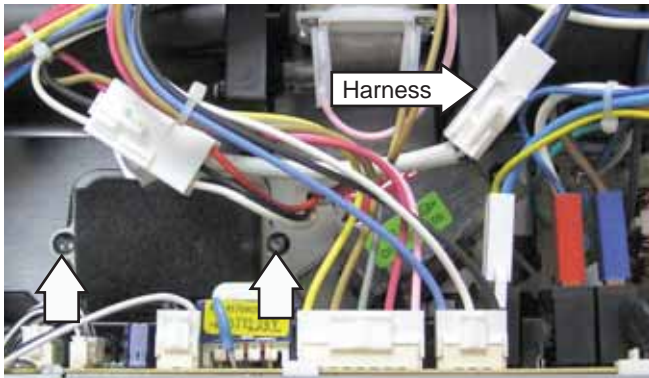

Harness

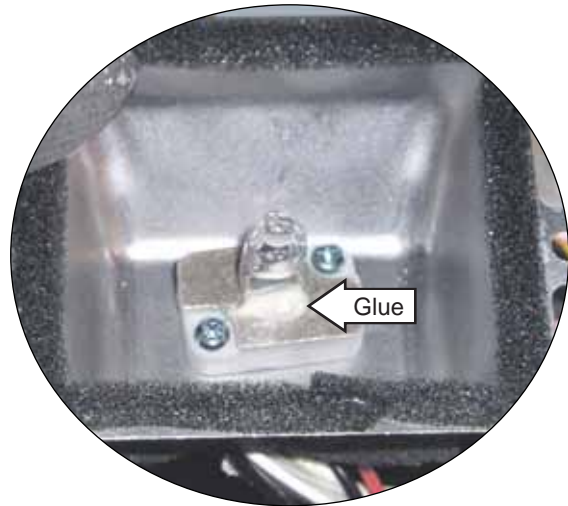

Glue

Light Housing Interior

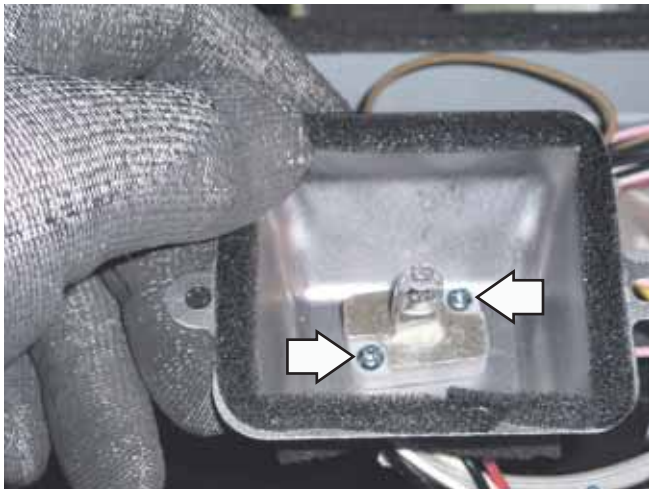

- The holder assembly (bulb not included) is available separately. (Part # WB06X10726).

Light Removed From Housing Interior



Holder Assembly

Caution

- Do not twist the lamp. The bulb may be glued to the holder assembly.
- Using gloves or a dry cloth, remove the replacement bulb from its packaging. Do not touch the bulb with bare fingers. Oil from bare fingers may cause hot spots on the glass surface and lead to premature failure of the bulb. If you do touch the glass, clean it with alcohol prior to installation.

Noise Filter

The noise filter helps to suppress electromagnetic interference (EMI) radiating from the operation of the oven and also protects the oven from any line noise. The noise filter is located on the right side of the oven behind the control panel and in front of the circulation blower assembly. The noise filter is held in place by a single Phillips-head screw. The filter ground wire is attached to the low voltage transformer (#2) right-side Phillips-head screw. The outer cover must be removed to access the noise filter. (See *Oven Removal / Partial Removal*.)

Note: When installing the noise filter, ensure all filter wiring is connected to the correct terminals.

Top View of Noise Filter
(Wires Removed from Relays for Clarity)

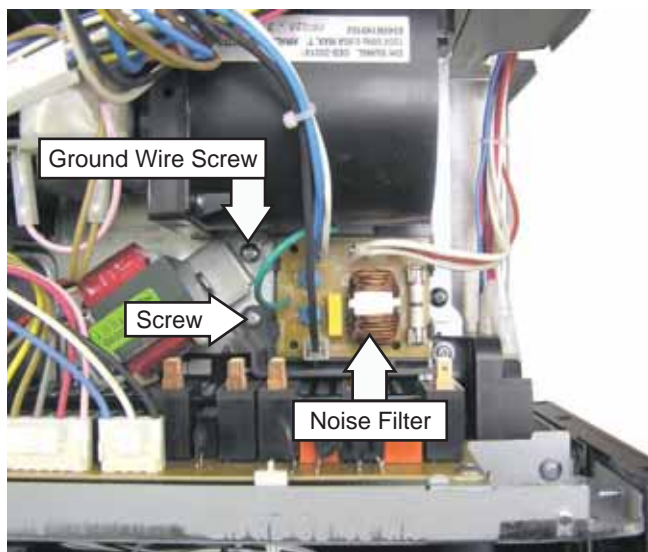

Check to make sure the fuse is not open. Check the noise filter for approximate resistance value at the following locations:

White (neutral input) to white/blue (neutral output) - 0 Ω .

Red (line input) to black (line output) - 0 Ω .

White (neutral input) to red (line input) - 23 Ω .

Noise Filter Fuse

Important Note: The primary interlock, monitor interlock, door sensing (secondary interlock) switches, and the relay board must all be replaced when the 20 amp fuse opens due to operation of the monitor interlock switch.

The unit is equipped with a 20-amp fuse (Part # WB27X10388).

The fuse is located in a receptacle near the top of the noise filter and is common to all functions and door switches.

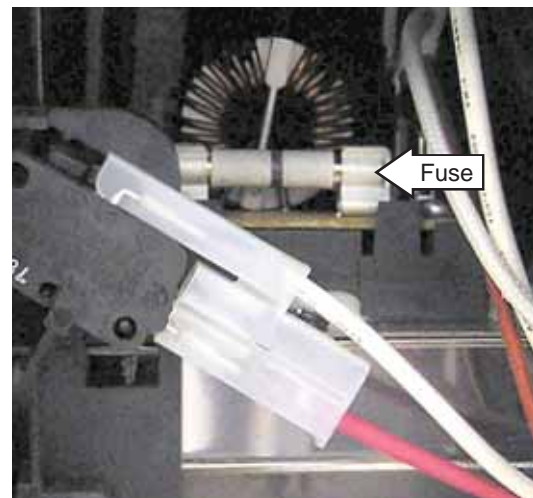

Note: If the fuse opens, it will disable all oven functions including the display. The oven must be partially removed to access the fuse. (See *Oven Removal / Partial Removal*.)

Surge Filter

The surge filter protects components of the oven against damaging electrical surges or power spikes such as lightning. The surge filter is located on the right side of the oven behind the circulation motor assembly and to the right of the magnetron. The surge filter is held in place by a single Phillips-head screw. The surge filter ground wire is attached to the oven chassis with a single Phillips-head screw. The outer cover must be removed to access the surge filter. (See *Oven Removal / Partial Removal*.)

Note: When installing the surge filter, ensure that the filter wiring harness is connected to the correct filter terminals.

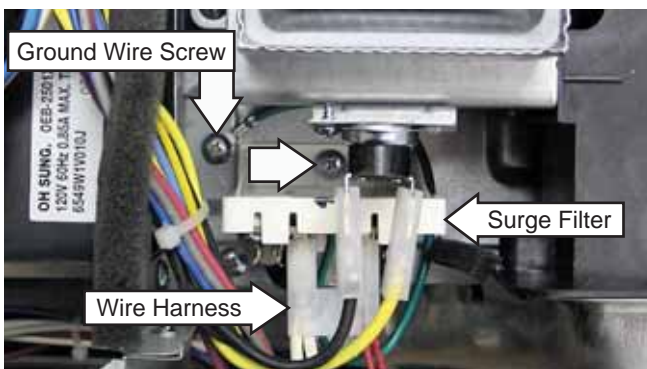

Surge Filter Fuses

The surge filter fuses are located on separate receptacles on the surge filter.

Note: If either or both of the fuses open, it will not disable oven functions or the display. The fuses main purpose is to protect certain oven components from damage by lightning. To access the fuses, it is necessary to remove the oven from cabinet or wall opening and remove the outer cover. (See *Oven Removal / Partial Removal*.)

The surge filter is equipped with two 20 amp fuses (Part # WB27X10388).

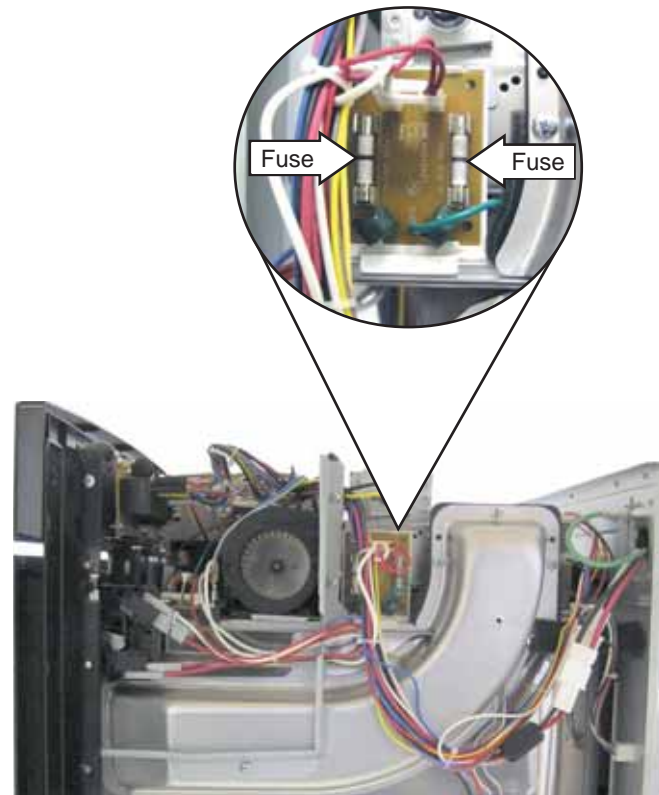

High Voltage Transformer

WARNING: Always be certain the capacitor is discharged before servicing. (See *Capacitor and Diode*.) Use electrician's discharge pliers and electrician's gloves under Kevlar gloves or equivalent protective gloves when discharging the capacitor.

Note: The capacitor has an internal discharge resistor that automatically discharges the capacitor when the oven turns OFF. Under normal operation, the capacitor should fully discharge within 30 seconds.

The transformer steps up 120 VAC line voltage to high voltage, which is then changed to an even higher DC voltage by the capacitor and diode.

The oven must be removed to access the high voltage transformer. (See *Oven Removal / Partial Removal*.) The high voltage transformer is located behind the top access cover. The top access cover is held in place by 2 Phillips-head screws.

The transformer is held in place with 4 Phillips-head screws. Two of the screws are recessed from the top of the outer cover. Access holes are provided. A magnetic screwdriver is necessary to capture these screws.

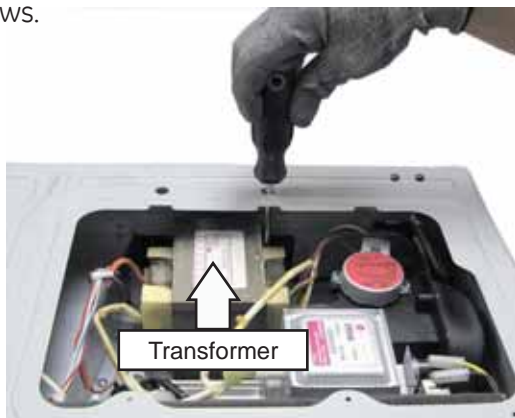

When disconnecting the primary and secondary wire connections, note the wire locations. The wire connectors use releasing locking tabs.

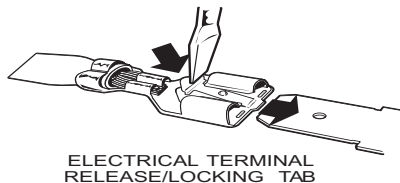

Check the high voltage transformer windings for approximate resistance value between:

Red to white (primary) - .5 Ω

Red/Black to chassis ground (secondary) - 87 Ω

Magnetron harness (filament high voltage) - .2 Ω

Capacitor and Diode

WARNING: Always be certain the capacitor is discharged before servicing. Use electrician's discharge pliers and electrician's gloves under Kevlar gloves or equivalent protective gloves when discharging the capacitor. Place the pliers between the diode connection of the capacitor and the oven chassis ground.



Note: The capacitor has an internal discharge resistor that automatically discharges the capacitor when the oven turns OFF. Under normal operation, capacitor should fully discharge within 30 seconds.

The diode works along with the capacitor to effectively double the already-high voltage that is provided by the power transformer. This voltage, approximately 3000 - 5000 VDC, is applied to the magnetron tube, causing it to produce the microwave energy that cooks the food.

The oven must be removed to access the capacitor. (See *Oven Removal / Partial Removal*.) The capacitor is located behind the top access cover. A single Phillips-head screw attaches the capacitor and diode to the oven chassis.

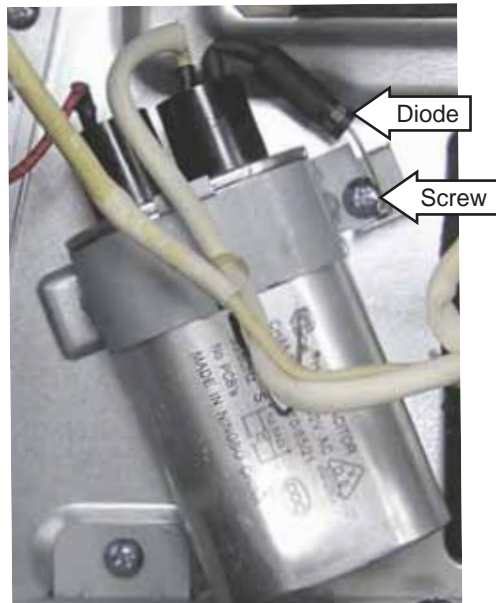

Note

1. When disconnecting the wires and diode from the capacitor, note wire and diode locations.
2. The capacitor wires have locking tabs. It is helpful to first remove the capacitor, capacitor bracket, and diode as one assembly.
3. The electrical terminal ends, which attach to the high-voltage capacitor have locking tabs on them. These tabs cannot be seen because they are encased in plastic. To remove these terminals, grasp the top and bottom of the terminal with needle-nose pliers. Gently squeeze the pliers jaws together while pulling the electrical terminal from the capacitor.

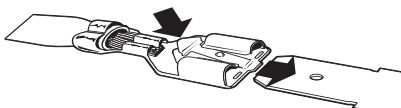

ELECTRICAL TERMINAL RELEASE/LOCKING TAB SHOWN WITH PLASTIC COVERING REMOVED

Magnetron and Magnetron TCO

WARNING: Always be certain the capacitor is discharged before servicing. (See *Capacitor and Diode*.) Use electrician's discharge pliers and electrician's gloves under Kevlar gloves or equivalent protective gloves when discharging the capacitor.

Note: The capacitor has an internal discharge resistor that automatically discharges the capacitor when the oven turns OFF. Under normal operation, the capacitor should fully discharge within 30 seconds.

The magnetron converts the high voltage supplied by the transformer, capacitor, and diode into radio frequency waves of electromagnetic cooking energy.

The oven must be removed to access the magnetron. (See *Oven Removal / Partial Removal*.) The magnetron is located behind the top access cover. The top access cover is held in place by 2 Phillips-head screws. The magnetron is held in place by 4 Phillips-head screws. The magnetron TCO bracket must be removed and the filament wire harness must be disconnected before removing the magnetron.

To check the magnetron filament for continuity it is necessary to disconnect the filament wire harness. The magnetron filament has a resistance value of less than 1 Ω .

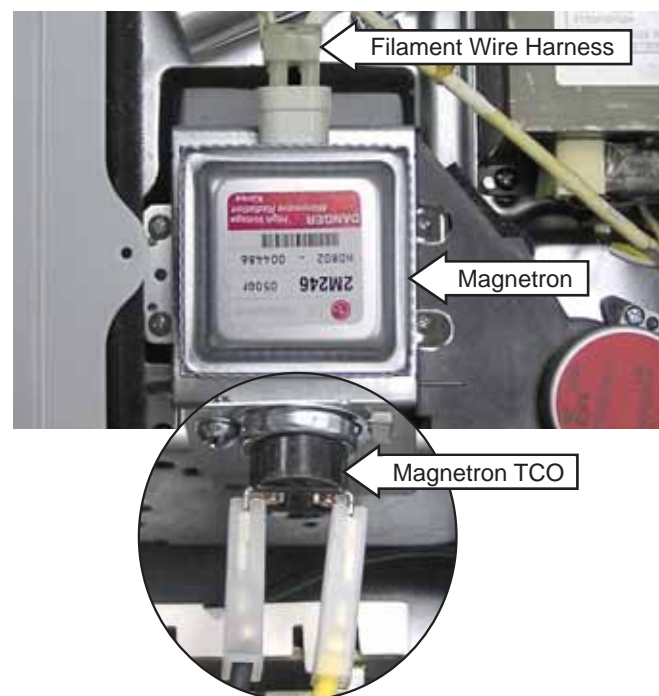

Magnetron Thermal Cut-Out (TCO)

The magnetron TCO is attached to a bracket mounted to the magnetron. The magnetron TCO bracket is held in place by a single Phillips-head screw.

This position of the magnetron TCO allows it to sense the temperature of the magnetron.

The magnetron TCO opens at 302°F and cannot be reset. If the magnetron TCO opens, it will disable all oven functions including the display.

Damper Assembly

The damper assembly is on the top right side of the oven cavity. When the damper door is closed, moisture is retained in the oven cavity. When the damper door is open, moisture is released, allowing food to be more crisp.

The outer cover must be removed to access or observe operation of the damper assembly. (See *Oven Removal / Partial Removal*.)

The damper assembly is held in place by 2 pins and 3 Phillips-head screws that attach the damper assembly to the oven chassis. When removing, move the damper assembly inward to disengage the 2 pins from the vent tube.

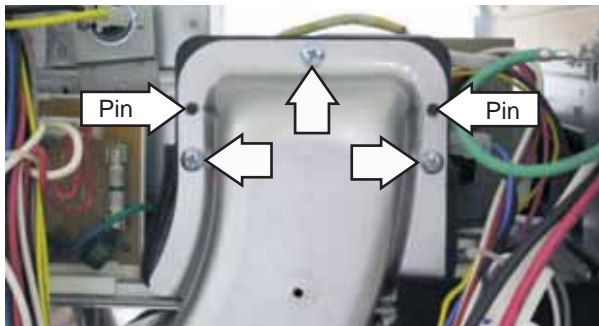

Damper Door Switch

The damper door sensing switch is mounted on the damper assembly. The switch monitors the damper door position and provides this information to the main PCB, which

controls the operation of the damper door motor. When the damper door is closed, the switch is open. The motor will run until the switch

sends the door closed signal. If the damper door sensing switch circuit shorts (or opens), the damper motor will run continually. The damper motor has an approximate resistance value of 3.36 K Ω .

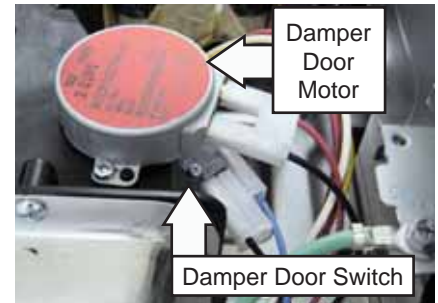

Damper Door Operating Modes

Cooking Mode	Damper Position	Switch Plunger Position	Switch Contacts
Microwave	Open	Not Depressed	Closed
Speedcook	Closed	Depressed	Open

Circulation Blower Assembly

The circulation blower protects the oven from too much heat inside the oven cavity. It automatically turns on if it senses too much heat. The blower will automatically turn off when the internal parts are cool. It may stay on for 3 minutes or more after the oven control is turned off.

The circulation motor has an approximate resistance value of 14 Ω .

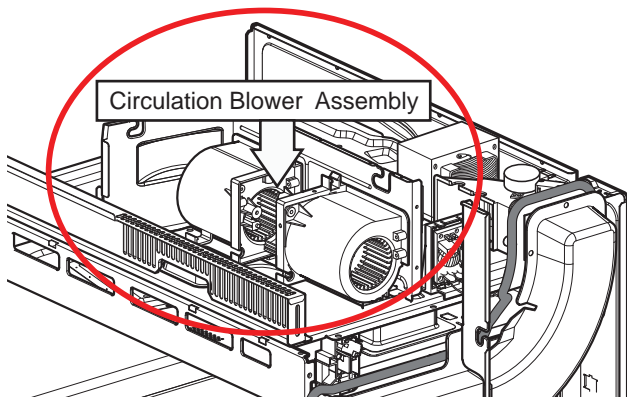

To remove the circulation blower assembly:

1. Remove the oven from cabinet or wall opening and remove the outer cover. (See *Oven Removal / Partial Removal*.)
2. Disconnect the 2 wires from the circulation motor.
3. Remove wiring from the wire retainer attached to the left rear of the circulation blower bracket.
3. Peel back the foam seal from the circulation blower bracket to expose the 2 wire guide slots.
4. Remove wiring from the guide slots in the circulation blower bracket.

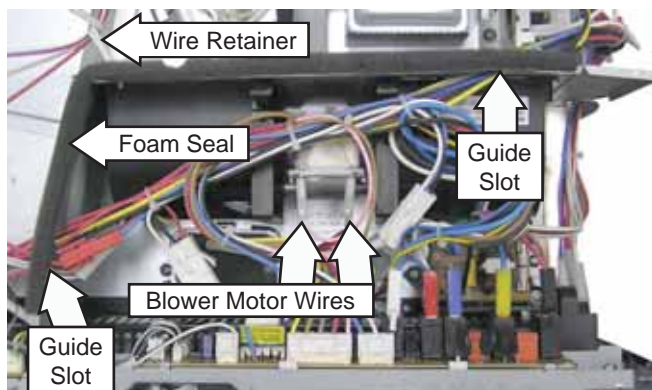

5. Remove the single Phillips-head screw that attaches the filter ground wire to the oven chassis.
6. Remove the 3 Phillips-head screws from the right side of the circulation motor bracket.

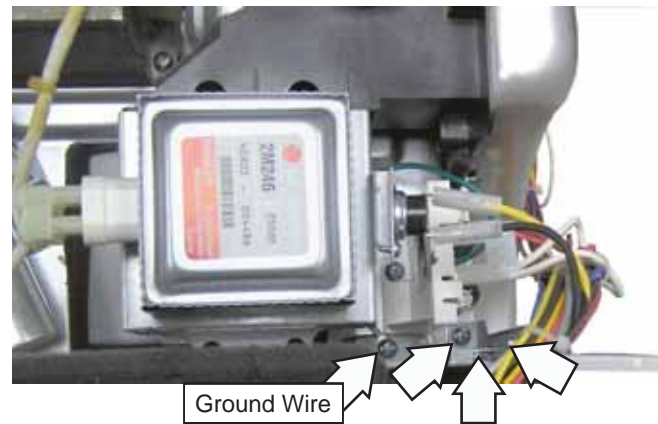

7. Remove the 3 Phillips-head screws from the left side of the circulation motor bracket.
8. Lift the circulation motor assembly, carefully move it towards the left side of the oven, then remove it from the oven.

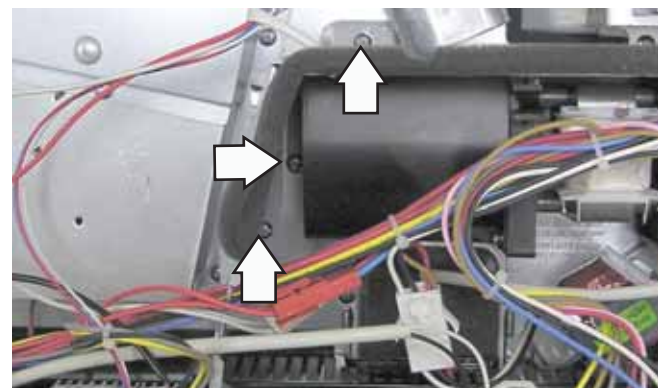

9. Remove the 6 Phillips-head screws that hold the circulation motor housing to the bracket.

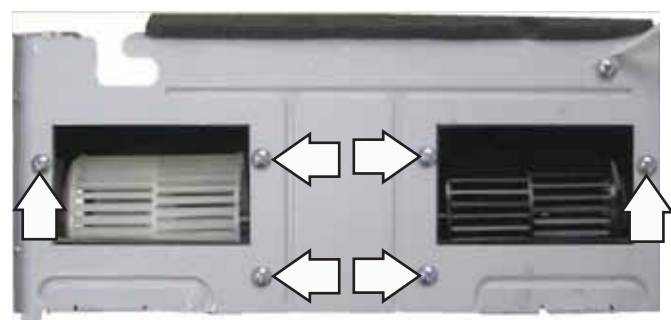

Note: When installing the circulation blower assembly, ensure that the filter ground wire is secured to the oven chassis.

(Continued Next Page)

Upper Heaters, Convection, and Oven Cavity TCOs

Each upper heater is connected to a TCO that automatically shuts off the halogen heater in the event of excessive temperatures. An open upper heater TCO will allow convection and microwave operation.

The convection heater is connected to a TCO that automatically shuts off the convection heater in the event of excessive temperatures. An open convection heater TCO will allow halogen heater and microwave operation.

The oven cavity TCO, when open, will disconnect L1 voltage to the power board and all oven functions will not operate, including the display.

When replacing a TCO, be sure to determine the cause of failure. The convection heater TCO can be accessed by removing the rear cover. The outer cover must be removed to access the upper heaters, magnetron, and oven TCOs. (See *Oven Removal / Partial Removal*.)

- The upper heater TCOs are mounted on the heat shield above the upper heater assembly.
- The oven cavity TCO is mounted on the exhaust duct on the left side of the oven.
- The convection heater TCO is mounted on a metal plate that is attached to the convection motor bracket.
- All TCOs are held in place by a single Phillips-head screw.
- All TCOs open at 302°F and cannot be reset.

Upper Heater TCO

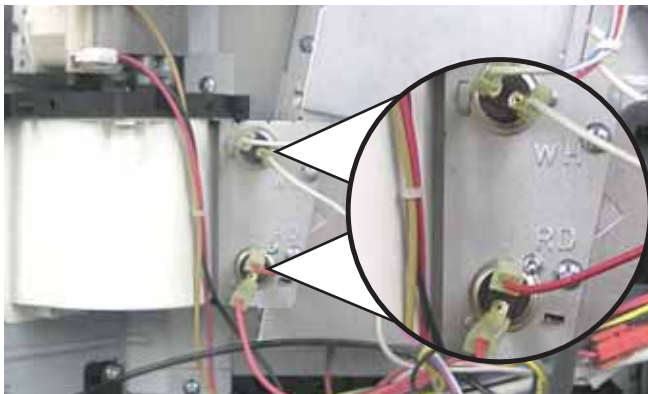

Oven Cavity TCO

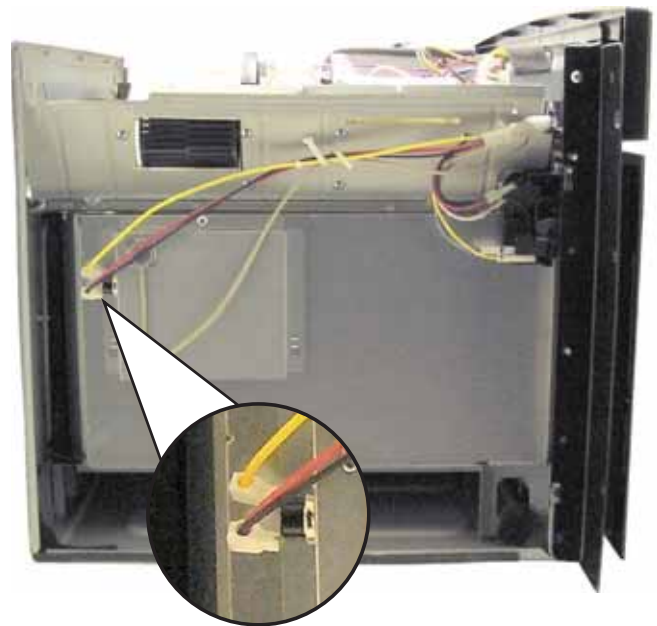

Convection Heater TCO

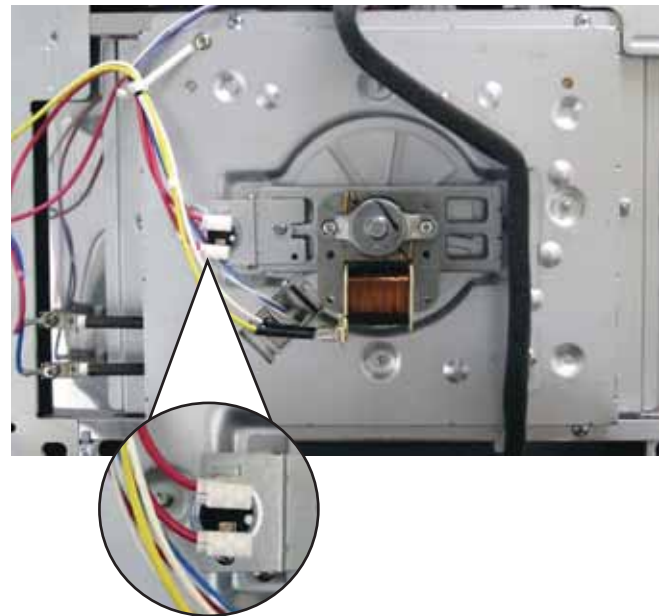

Vent Motor Assembly

The vent motor assembly helps remove heat from all components. The vent blower comes on during Speedcook and after using convection cooking. At the end of Speedcooking, or after using convection cooking, the vent blower will operate for approximately 1 minute and the display will read "OVEN IS COOLING." The vent blower will automatically shut off when the internal parts of the oven have cooled.

The exhaust motor has an approximate resistance value of 14 Ω .

To remove the exhaust motor assembly:

1. Remove the oven from cabinet or wall opening and remove the outer cover. (See *Oven Removal / Partial Removal*.)
2. Disconnect the wires from the exhaust motor.



3. Remove the 6 Phillips-head screws and the exhaust motor assembly from the oven chassis.

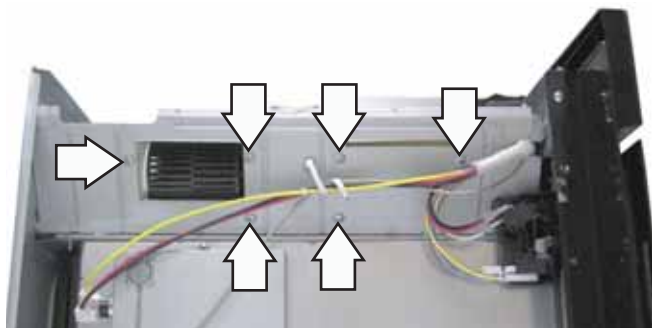

Upper Heater Assembly

Each halogen heater has an approximate resistance value of 1.8 to 3.7 Ω . The outer heater is connected with 2 red wires and the inner heater is connected with 2 white wires.

To remove the upper heater assembly:

1. Remove the oven from cabinet or wall opening and remove the outer cover. (See *Oven Removal / Partial Removal*.)
2. Disconnect wires from the 2 halogen TCOs.
3. Remove 4 Phillips-head screws that attach the TCO bracket and straighten the 2 folded lock tabs.
4. Pull the top of the vent motor assembly down and outward and lift off the TCO bracket.

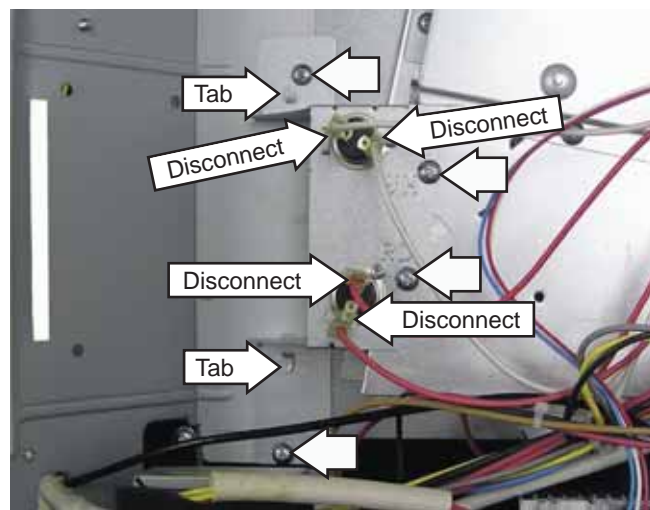

5. Disconnect the heater assembly wire harnesses and pull them through the wire guide.

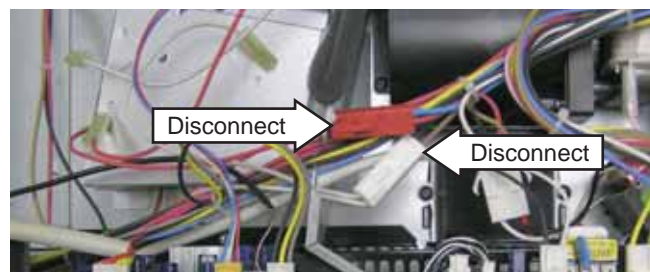

6. Remove the wiring from the wire tie.
7. Remove the top Phillips-head screw from the rear cover.
8. Remove the 9 Phillips-head screws and the heater shield from the heater assembly.

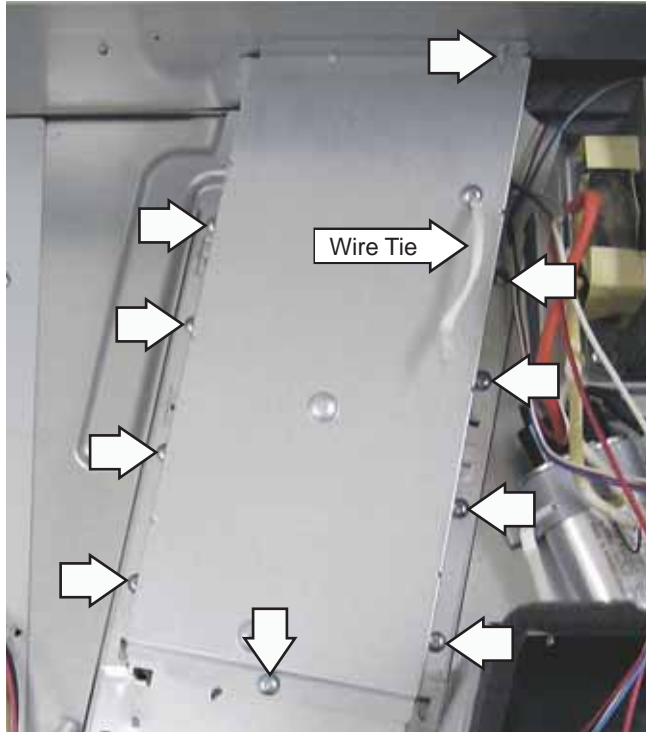

9. Remove the 5 Phillips-head screws and straighten the 4 folded lock tabs, then lift off the heater cover.

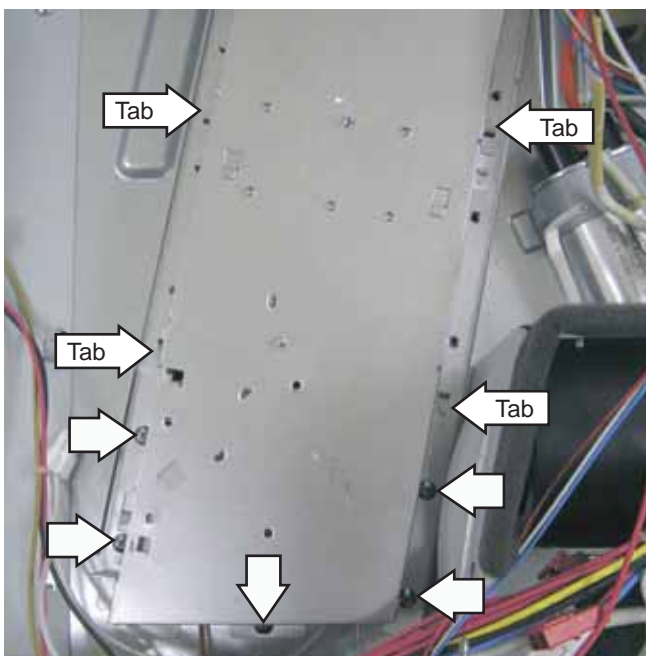

10. Carefully lift the heater assembly from the oven chassis.



Bottom View of Halogen Heater Assembly

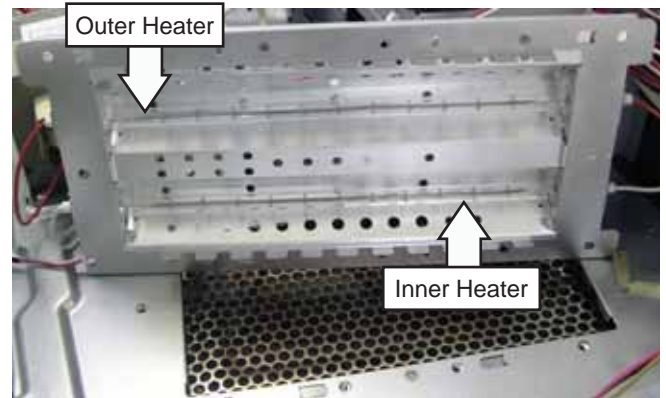

Lower Heater Assembly

The lower ceramic heater has an approximate resistance value of 27 to 42 Ω .

To remove the lower heater assembly:

1. Remove the oven from cabinet or wall opening. (See *Oven Removal / Partial Removal*.)
2. Remove the 2 Phillips-head screws from the bottom of each side of the outer cover.
3. Remove the 6 Phillips-head screws that attach the bottom to the oven.

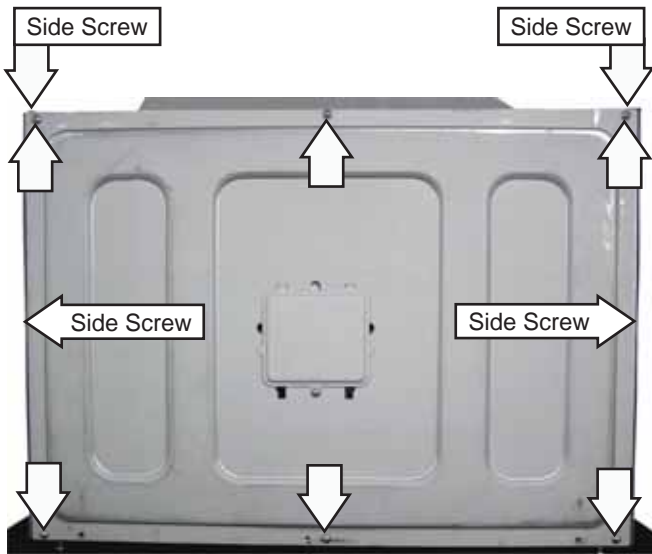

4. Disconnect the bottom heater and turntable wire harnesses.
5. Remove the 4 Phillips-head screws and the reflector from the oven chassis.
6. Remove the single Phillips-head screw that holds the heater assembly to the oven chassis.

Bottom View with Baseplate Removed



Caution: To prevent damage to the heater and turntable wiring, be sure wiring is placed inside the wiring cut-out in the chassis before installing oven bottom.

Convection Heater Assembly and Thermistor

The convection heater assembly is located behind the rear cover and is composed of an inner and outer fan blade, motor, heating element, and thermistor assembly. Three Phillips-head screws and 4 tabs hold the rear cover in place.

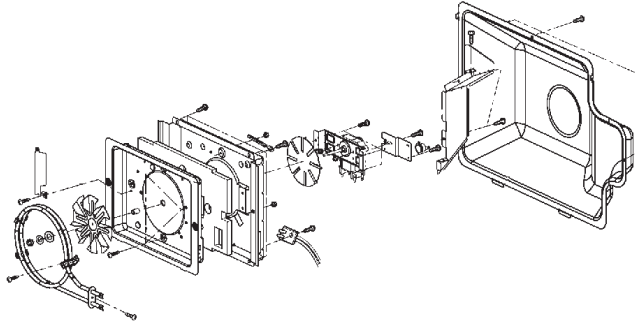

The oven must be removed from the cabinet or wall opening to access the convection heater assembly. (See *Oven Removal / Partial Removal*.)

Thermistor Assembly

The thermistor assembly consists of two separate thermistors (thermal sensors) attached to the convection assembly by a single Phillips-head screw. The upper thermistor (blue and white wires) is used for thermal compensation and more control in a higher temperature range (above 300°F) for Speed Cook, Broil, Toast, and Convection. The lower thermistor (red and white wires) is used for more control in a lower temperature range (below 300°F) and is used for Proof and Warm.

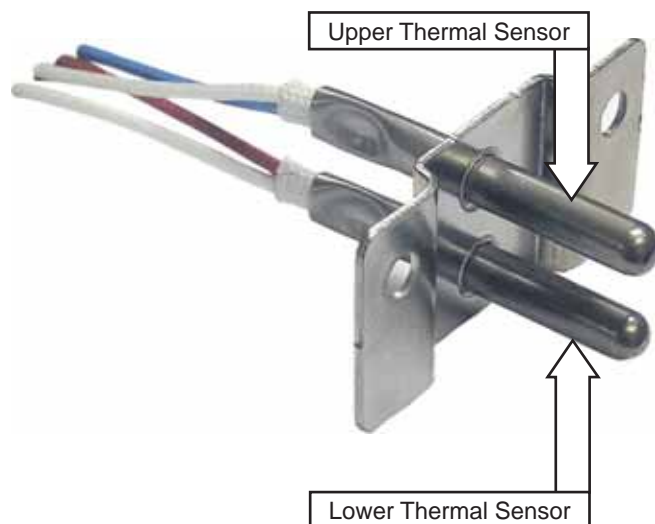

The thermistor assembly is connected to the power board at location CN9. The thermistors have a negative coefficient. As the temperature increases, the thermistor's resistance decreases. The approximate values at room temperature are: Red - Blue = 400K Ω ; Red - White = 290K Ω ; Blue - White = 110K Ω .

Convection Heater Assembly Shown with Rear Cover Removed

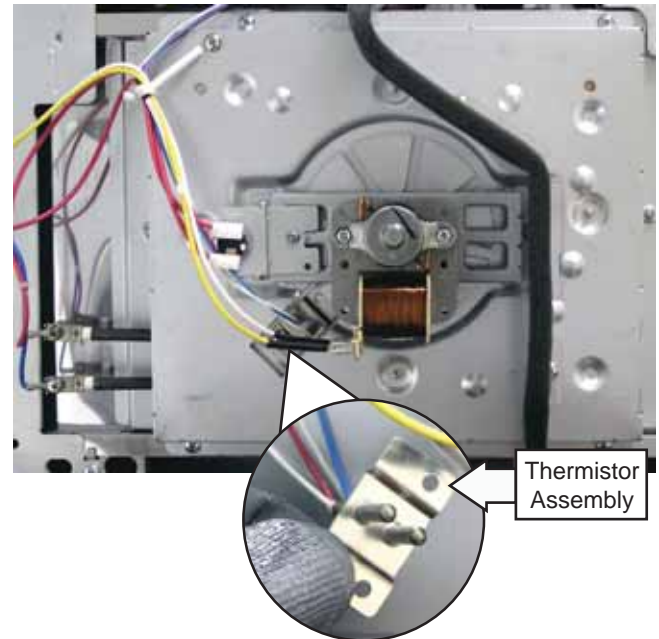

Convection Heater Element

The convection heater assembly is held in place by two 7-mm hex-nuts and 4 Phillips-head screws. The convection heater element has an approximate resistance value of 6 to 12 Ω . Two Phillips-head screws connect the power wires to the element terminals.

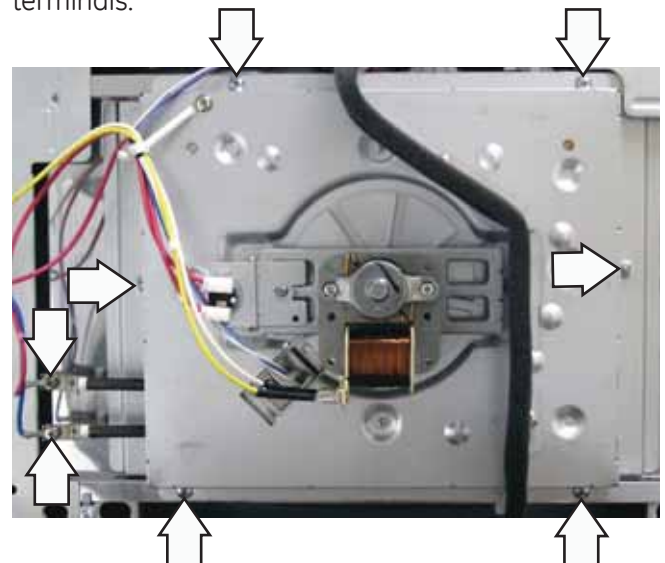

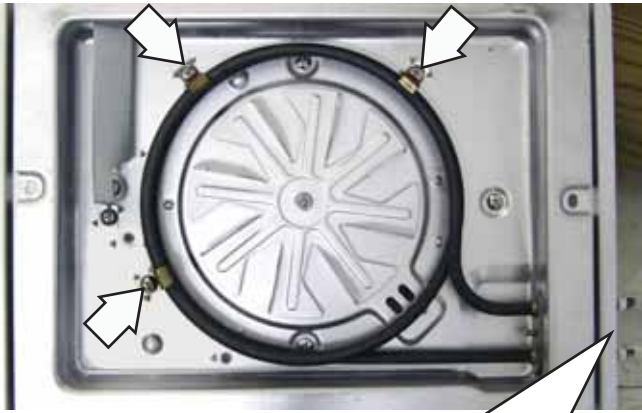

The convection heater element is held in place by 4 Phillips-head screws. (Three screws on the front, and 1 screw on the end.)



End View of Element

Each convection power level setting directs the convection cooking system to operate within certain parameters as shown in the table below.

Convection Cooking Chart		
Power Level	Temperature	Operation
0	Room	See Note 1
1	300°F	See Note 2
2	310°F	See Note 2
3	320°F	See Note 2
4	330°F	See Note 2
5	340°F	See Note 2
6	350°F	See Note 3
7	375°F	See Note 3
8	400°F	See Note 3
9	425°F	See Note 3
10	450°F	See Note 3

Notes:

1. Convection element not ON.
2. Reaches temperature and then cycles at temperature for remainder of programmed time.
3. Reaches temperature and then cycles at 350°F for remainder of programmed time.

Convection Fan Motor

The convection fan motor wire leads have locking tabs that must be depressed to be disconnected. To remove each wire from the fan motor, depress the clip using a small blade screwdriver and pull the wire off the terminal as shown.

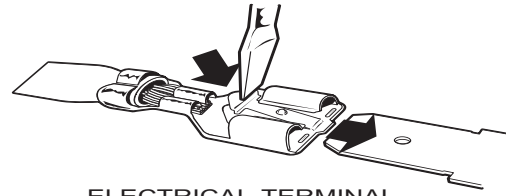

ELECTRICAL TERMINAL RELEASE/LOCKING TAB

The outer convection fan must be removed before removing the motor. The outer convection fan is held in place by a 7-mm nut, lockwasher, spacer and flat washer.

Front View of Outer Convection Fan

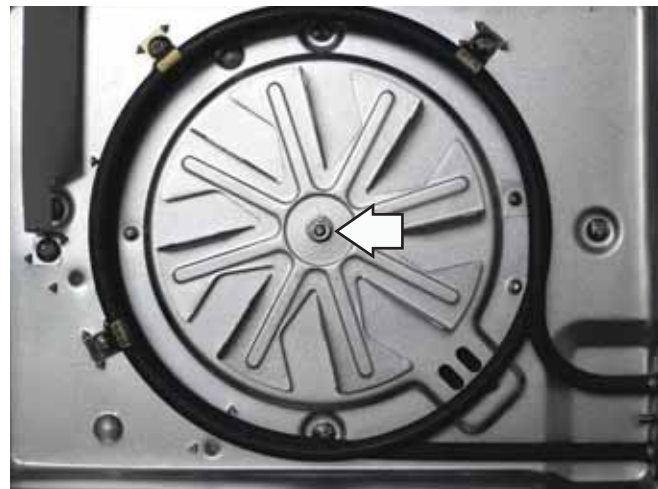

The convection fan motor is held in place by 3 Phillips-head screws. The convection fan motor has an approximate resistance value of 31 Ω.

Rear View of Convection Fan

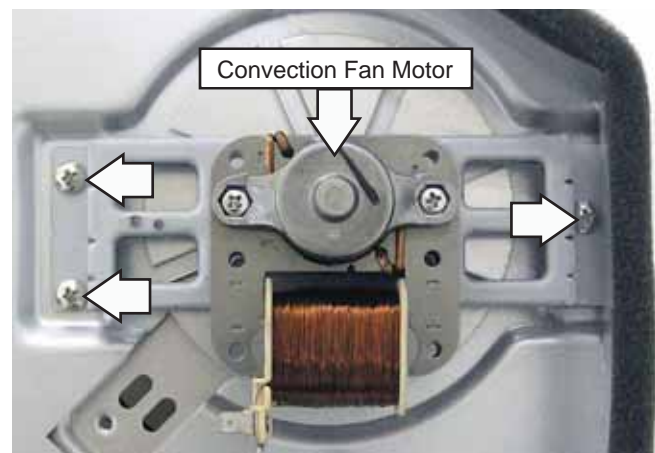

Humidity Sensor

The humidity sensor is mounted on the exhaust duct on the left side of the oven. The outer cover must be removed to access the humidity sensor. (See *Oven Removal / Partial Removal*.) The humidity sensor is connected to the power board at location CN8. The humidity sensor is held in place by 2 Phillips-head screws.

The humidity sensor detects the increasing humidity released during cooking. The oven automatically adjusts the cooking time to various types and amounts of food.

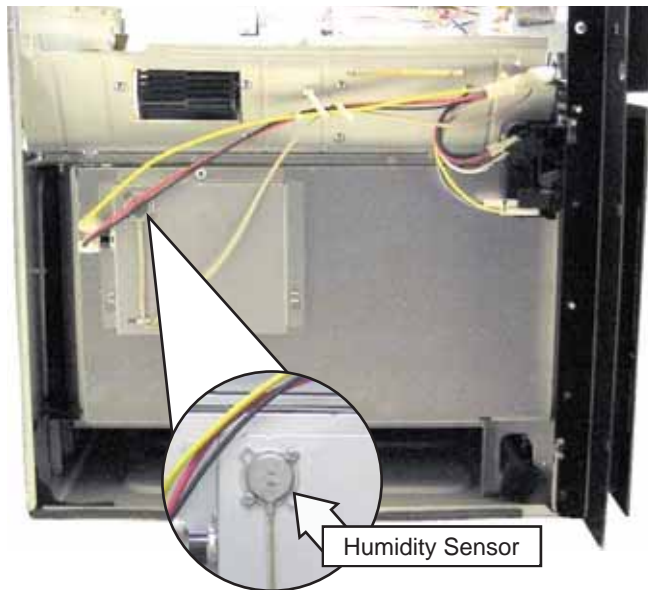

Humidity Sensor Test

Note:

- The oven should be plugged in at least 5 minutes before test.
- Room temperature should not exceed 95°F.
- Be sure the exterior of the cooking container and interior of the oven are dry.
- No sensor cooking is available while the oven is hot. Wait 5 minutes to allow oven to cool enough to use sensor cooking.

To test the humidity sensor, it is necessary to access the control panel. (See Control Panel Assembly.) The humidity sensor wire harness must be disconnected from CN8 on the power board. On the humidity sensor wire harness, check for approximate resistance values between:

- Black-Red = 6.5 K Ω
- Red-White = 3.25 K Ω
- Black-White = 3.25 K Ω

Turntable Motor

The turntable rotates food for even cooking during all cook cycles. The turntable motor is held in place with 2 Phillips-head screws. To replace it requires removing the turntable, turntable support, and the oven from the cabinet or wall opening. (See *Oven Removal / Partial Removal*.) A single Phillips-head screw attaches an access panel to the bottom of the oven. A single wire harness is connected to the turntable motor.

The turntable motor has an approximate resistance value of 2.6 K Ω .



Note

- When replacing the turntable motor, be sure the RF gasket is positioned over the motor shaft and between the motor and motor plate, as shown below.
- When replacing the turntable support, ensure it is fully seated into the "D" shaped shaft of the turntable motor and is flush with the oven floor.

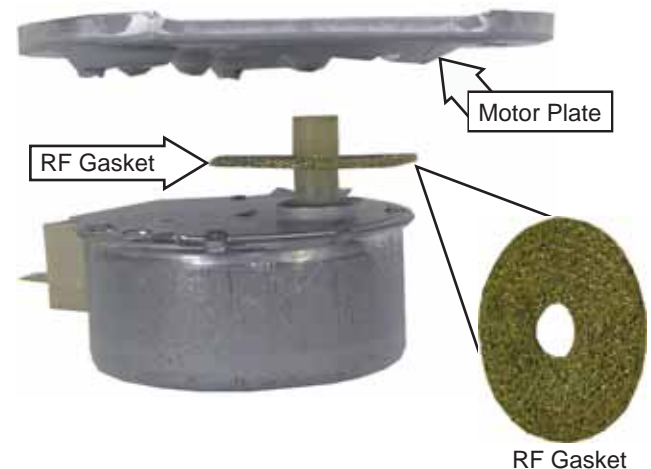

Left and Right Door Switch Assemblies

The primary interlock, monitor interlock, and door sensing (secondary interlock) switches function together as an interlock system. The primary purpose of the interlock system is to interrupt the production of microwave energy when the oven door is opened, and similarly, to prevent any microwave output until the door is firmly and safely closed.

When the door is opened, first the primary switch opens its contacts. Second, the door sensing switch opens. Finally, the monitor interlock switch closes its contacts. If any of the switches fail to open their contacts properly when the door is opened, a short circuit is created when the monitor interlock switch closes its contacts and the noise filter fuse will open.

Note: If the door sensing switch is open, the display will tell the user to “close the door” – user can program the unit but no cook function will operate.

If the primary door switch is open, the display will function but microwave heating, and the turntable, convection, and damper motors will not operate.

The purpose of the halogen heater interlock switch is to prevent halogen heater operation when the door is open.

The primary interlock, monitor interlock, door sensing, and halogen heater interlock switches are mounted on plastic latch boards. The latch boards are attached to the left and right side of the oven cavity. The left side latch board contains the door sensing (secondary interlock) and halogen switches. The right side latch board contains the primary interlock and monitor interlock switches.

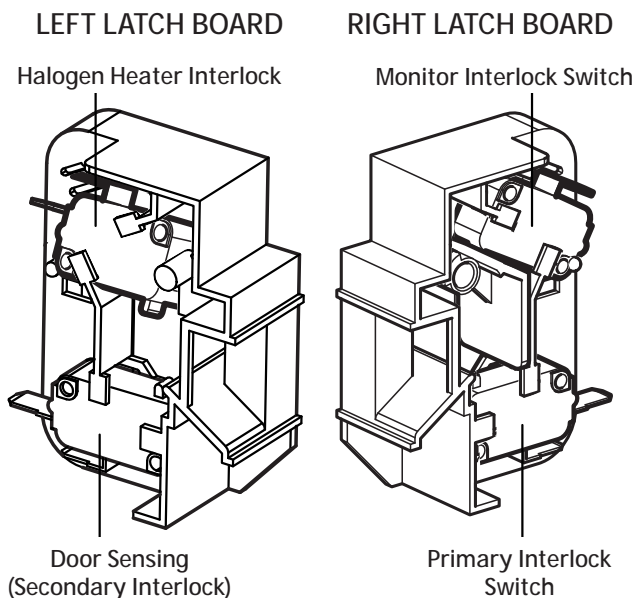

Right side Latch Board Shown

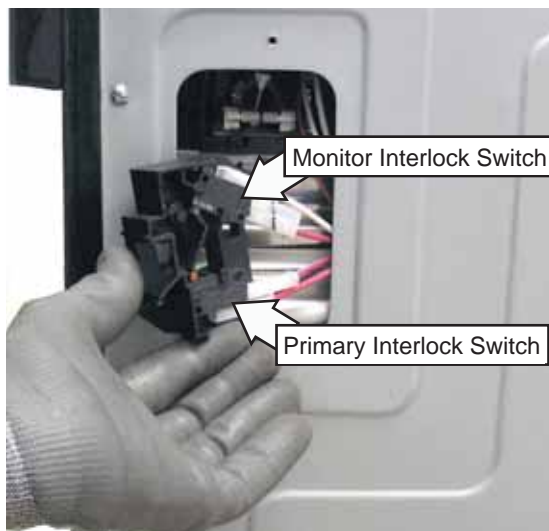

How to Test Primary Interlock, Door Sensing, and Halogen Switches:

1. Disconnect power and partially remove the oven from its installation. (See *Oven Removal / Partial Removal*.)
2. Remove the single Phillips-head screw that holds each door switch access cover to the outer cover.
3. Remove the primary interlock, door sensing, and halogen switch leads to isolate each switch.
4. Check continuity of each switch with door open and door closed. Normal readings are as follows:
 - Door Closed: 0 Ω
 - Door Open: Infinity

How to Test the Monitor Switch:

Note: The right side latch pawl pushes horizontally and actuates the lever of the monitor interlock, opening the switch.

1. Disconnect power and partially remove the oven from its installation. (See *Oven Removal / Partial Removal*.)
2. Remove the single Phillips-head screw that holds the right side door switch access cover to the outer cover.
3. Remove the monitor switch leads to isolate the switch.

4. Check continuity of the switch with door open and door closed. Normal readings are as follows:

- Door Closed: Infinity
- Door Open: 0 Ω

How to Test Interlock System:

1. Disconnect power, remove the outer cover (See *Oven Removal / Partial Removal*) and discharge capacitor.
2. Check 20 amp fuse for continuity and proper size. Do not use any other fuse or size except 20 amp.
3. Remove monitor switch leads to isolate switch. Check continuity of switch with door open and door closed.
 - Door Closed: Infinity Ω
 - Door Open: 0 Ω
4. Reconnect switch wiring.
5. Test Circuit Operation.
 - a. Connect temporary jumper leads across RY14 relay contacts, primary interlock and door sensing switches to simulate shorted switch contacts. Locate convenient connections in circuit to be certain COM and NO terminals are used.
 - b. Connect ohmmeter (Rx1) across the L1 (red wire) and Neutral at the power inlet wire harnesses. Continuity must show the following:
 - Door Closed : Some Ω
 - Door Open : .3 Ω
 - c. Remove 20 amp fuse. Circuit must open (infinity Ω). If not, check wiring of monitor and interlock circuits.

WARNING: After test, remove temporary jumper leads from primary interlock and door sensing switches and RY14 relay.

WARNING: Primary interlock, door sensing switch, monitor switch, and relay board must be replaced when the 20 amp fuse is blown due to operation of monitor switch.

Note: Perform microwave leakage test when replacing or adjusting interlock switches or latch board.

How to Adjust the Interlocks:

The latch board is adjustable for proper door closure and switch operation.

1. Disconnect power and partially remove the oven from it's installation. (See *Oven Removal / Partial Removal*.)

Note: Each latch board is held in place and adjusted with 2 Phillips-head screws. The screws are recessed from the top of the outer cover. Access holes are provided.

2. Loosen the 2 Phillips-head screws that attach the latch board to the oven chassis.
3. Adjust each latch-board for proper door closure and switch operation, retighten screws.



Note: Perform microwave leakage test when replacing or adjusting interlock switches or latch boards.

To remove the door switches:

1. Place the oven in a partially removed position. (See *Oven Removal / Partial Removal*.)
2. Open the oven door.
3. Remove the single Phillips-head screw that holds the door switch access cover to the outer cover.
4. Disconnect the switch wiring.

- Using a flat blade screwdriver, carefully press the lock tab until flush with the surrounding area of the latch board.
- Using the mounting pin as a pivot, carefully rotate the switch past the lock tab and remove the switch from the mounting pin.

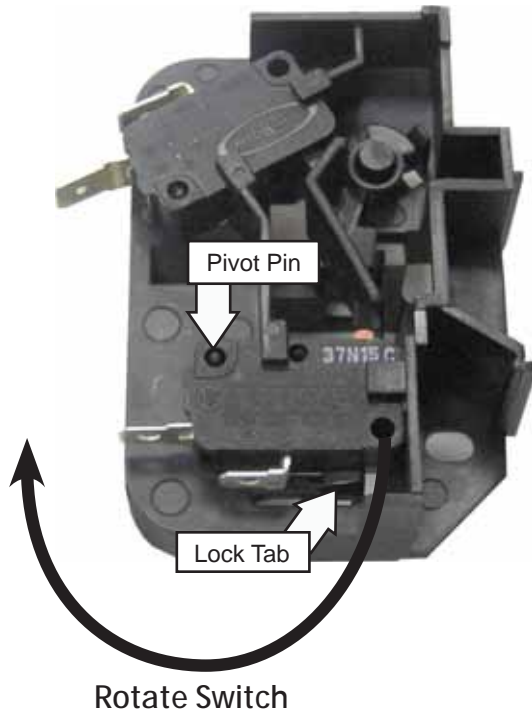

To replace the latch boards:

- Place the oven in a partially removed position. (See *Oven Removal / Partial Removal*.)
- Open the oven door.
- Remove the single Phillips-head screw that holds the door switch access cover to the outer cover.
- Disconnect the switch wiring.

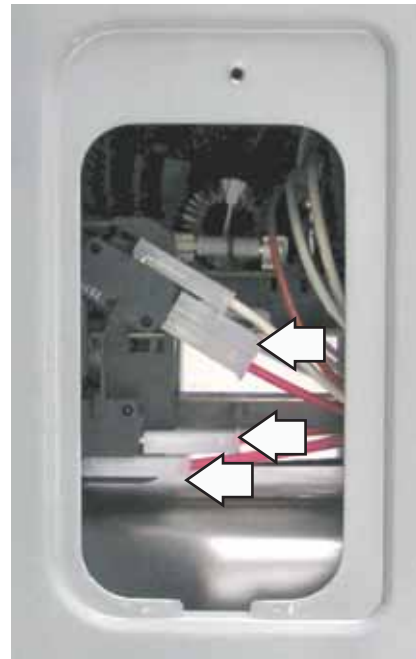

Note: Each latch board is held in place with 2 Phillips-head screws. The screws are recessed from the top of the outer cover. Access holes are provided. A magnetic screwdriver is necessary to capture these screws.

- Remove the 2 Phillips-head screws that attach the latch board to the oven chassis.



- Remove the door switches from the latch board.

Microwave Leak Test

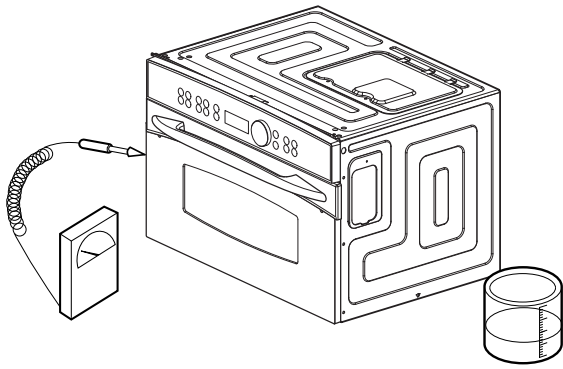

1. Place 275 ml water in 600 ml beaker. (Part # WB64x5010)
2. Place beaker in center of Clear Glass Tray.
3. Set meter to 2450 MHz scale.
4. Turn ON for 5-minute test.
5. Hold probe perpendicular to surface being tested. Scan surfaces at the rate of one inch per second. Scan entire perimeter of door, control panel, viewing surface of door window, and exhaust vents.
6. Maximum leakage is 4 MW/CM².
7. Record data on service invoice and microwave leakage report.

Note

- Maximum allowable leakage is 5 MW/CM². Four MW/CM² is used to allow for measurement and meter accuracy.
- Inform the manufacturer of any oven found to have emission in excess of 5 MW/CM². Make repairs to bring the unit into compliance at no cost to owner and try to determine cause. Instruct owner not to use oven until it has been brought into compliance.

Standard Test Load

The standard test load is one liter (1000 ml) water with starting temperature of 59°F ~ 75°F in a 1000 ml beaker. (DO NOT USE ANY OTHER LOAD OR DISH AS RESULTS WILL VARY FROM STANDARD.)

PERFORMANCE TEST FOR MICROWAVE

1. Use Clear Glass Tray and the beaker (Part # WB64x0073).
2. Record initial water temperature.
3. Run at high power for 2:03 minutes.
4. Record end water temperature. The minimum difference between the initial and ending temperature should be: 32°F @ 120V.

Sensor & Keypanel Failure Detection

The control will have software to constantly detect sensor open/short failures and abnormal high temperatures. After the failure occurs, 3 to 20 minutes may elapse before the failure will be displayed to the consumer. These failures will also be displayed in the service mode. The table below shows what will be displayed to the consumer after each particular failure is detected and to the technician when utilizing the service test mode.

Display Scrolls	
Upper Thermal Sensor OPEN	SERVICE MAY BE NEEDED
Upper Thermal Sensor SHORTED	
Humidity Sensor OPEN*	
Abnormal High Temp**	
Lower Thermal Sensor OPEN	
Lower Thermal Sensor SHORTED	

* Any defect of the humidity sensor will display OPEN.

** Oven temperature higher than the set temperature for more than 30 minutes.

GLASS TOUCH PANEL TEST

If necessary the glass touch panel pads can be verified by a continuity test. For ease of handling, the control panel should be removed and placed on a flat surface. Check continuity between patterns of the CN 14 on smart board.

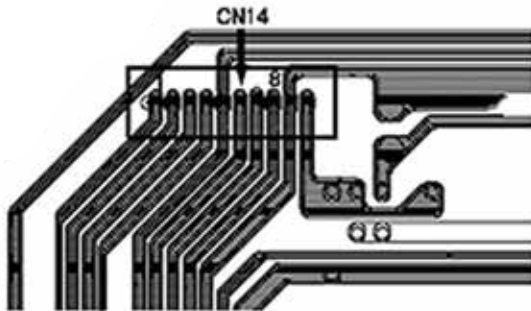

PAD	CONN. (CN14)	PAD	CONN. (CN14)
HELP	1 and 5	DEFROST	3 and 5
BACK	1 and 6	EXPRESS	3 and 6
CLEAR / OFF	1 and 7	BAKE / BROIL	3 and 7
FAVORITE RECIPES	1 and 8	SPEED COOK	3 and 8
OPTIONS	2 and 5	REHEAT	4 and 5
TIMER	2 and 6	CUSTOM SPEED COOK	4 and 6
POWER / TEMP	2 and 7	WARM / PROOF	4 and 7
START / PAUSE	2 and 8	COOK	4 and 8

Service Test Mode

Remove any trays (metal or glass) from the oven before starting the diagnostic mode and make sure that the door is closed. Removing the trays will allow you to see the operation of the turntable motor and the lower ceramic heater. Closing the door will make sure that all loads (i.e. the halogen lamps and magnetron) can be energized. Note that all safety components remain active in the service mode.

To start the service/diagnostics mode press the **SPEED COOK** pad and the **KNOB** for 3 seconds. To exit the service/diagnostics mode press the **CLEAR/OFF** key.

Upon entering into Field Service Mode, "**SERVICE MODE ON**" is displayed.



The main control will then automatically check the following:

1. The upper thermal sensor if open or shorted.
2. The humidity sensor for any fault condition.*
3. That the cavity temperature did not go above the set temperature for more than 30 minutes during a bake cycle.
4. The lower thermal sensor if open or shorted.

"**OK**" will display if the thermal sensors are not open or shorted and the humidity sensor is not faulty.

The control will then verify that the 3 sets of EEPROM data are correct and will display the voltage compensation set value.

* Any defect of the humidity sensor will display OPEN.

The control will then proceed to service/diagnostic mode. "**PRESS THE KNOB TO BEGIN DIAGNOSTICS CYCLE**" message will scroll across the screen. Press the **KNOB** to begin the diagnostics cycle and to advance to the next test. An individual test can be selected with additional pressing of the **KNOB**. The control will automatically set all power levels to 10, 100% ON (i.e. U=10 L=10 M=10 C=10).

Note: If you fail to select a following test within approximately 2 minutes, the control will exit the service mode.

1. The control will turn on the center upper halogen heater for 3.5 seconds.
2. The control will turn on the exterior upper halogen heater for 3.5 seconds.
3. The control will turn on the lower ceramic heater for 15 seconds. You will need to open the door to check for heat coming from the lower heater.
4. The control will turn on the turntable motor and oven light for 5 seconds.
5. The control will turn on the damper motor for 15 seconds. Make sure to listen for the operation of the damper motor. This is the only way to confirm the operation.
6. The control will turn on the convection fan and heater for 15 seconds. You will need to open the door to check for the convection fan rotating and to check for heat coming from the heater.

7. The control will turn on the magnetron and magnetron fan for 10 seconds.
8. The control will turn on the ventilation fan for 5 seconds. After the ventilation fan cycle is completed, the control will display a message: "**DIAGNOSTICS CHECK COMPLETE. TO START AGAIN, PRESS ENCODER KNOB AND SPEED COOK**".

If you press the **KNOB** now, "**SERVICE MODE COMPLETE**" is displayed and then the control will exit service mode.



Schematics and Wiring Diagrams

MODEL NAME	Smart Board Connectors	Secondary of LVT	Power Supply to Smart Board
PSB2200N	CN20 CN21	CN3(LVT)	CN101
PSB2201N			
ZSC2200N	1 0-15V 7.5V	18V	15V
ZSC2200N	2 0-15V 12V	GND	GND
ZSC2201N	3 0-15V 11V	7V	12V
ZSC2202N	4 0-15V GND	GND	
	5 0-15V 5V		
	6 0-15V 5V		
	7 0-12V 5V		
	8 0-12V 5V		
	9 0-12V 10V		
	10 0-12V 4V		
	11 0-12V 5V		
	12 0-12V 0-5V		
	13 0-12V 0-5V		
	14 0-12V 15V		
	15 0-12V		
	16 3V		

COLOR	SYMBOL
RED	R
WHITE	W
BLACK	BK
BLUE	BL
YELLOW	Y
GREEN	GN
BROWN	BN
GRAY	GY
PINK	P

GROUND

NOTE : To test, close door and apply power.

SCHEMATIC DIAGRAM

WARNING
POWER MUST BE DISCONNECTED BEFORE SERVICING THIS APPLIANCE

NOTE : Schematic shown with door open.

HEATER RESISTANCE AND CURRENT
HVT RESISTANCE AND CURRENT (ohm meter scale:R*1)

	Normal (Approximately)	Abnormal	Input current
Upper Halogens	1.2-2.5 ohms	Infinite	10 A
Lower Ceramic	23-33 ohms	Infinite or several	4.2 A
Conv. Sheath	6-12 ohms	Infinite	12.5 A
H.V.T	0.2-0.8 ohms	Infinite	16 A

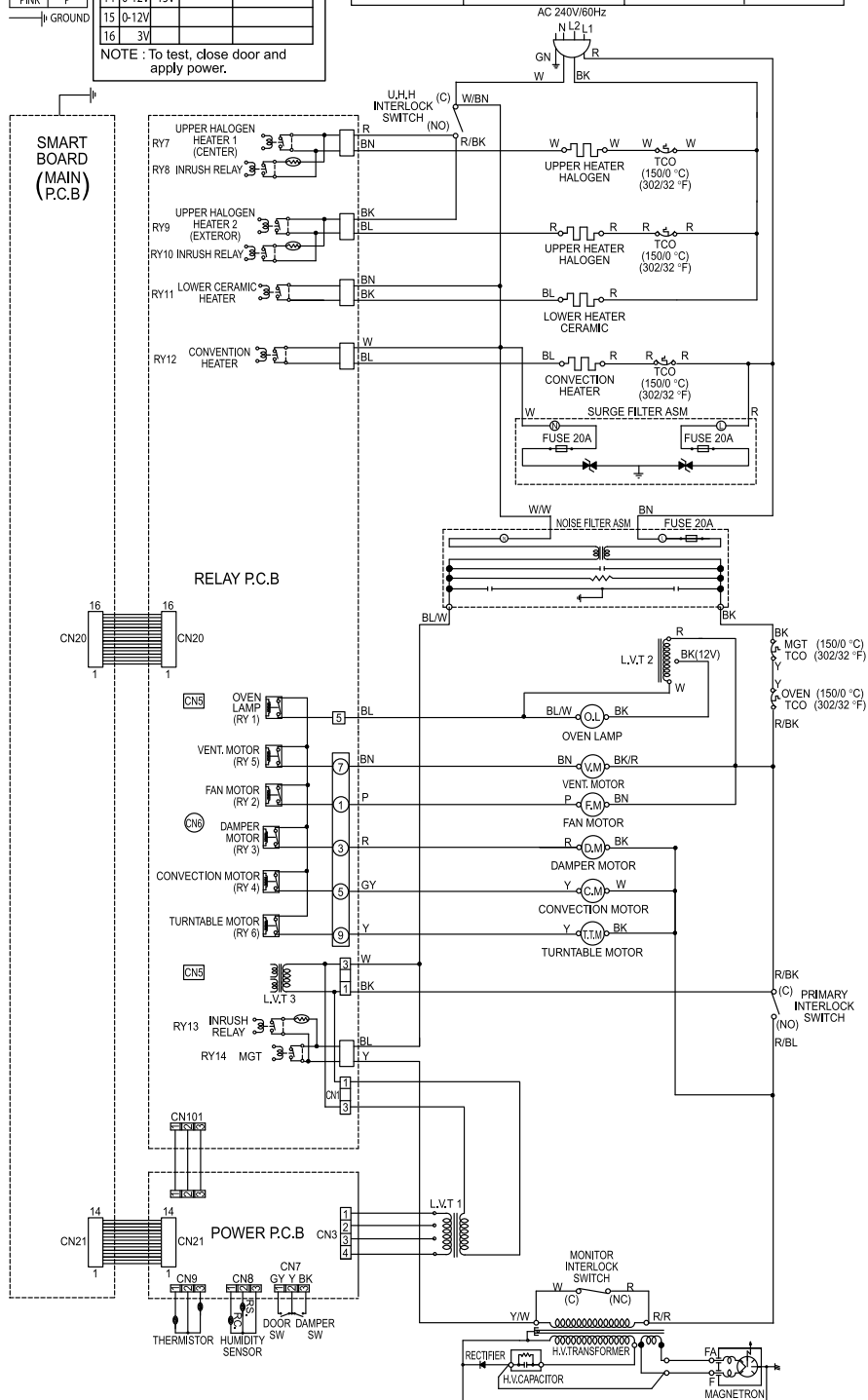

(Continued Next Page)

MODEL NAME
PSB2200N
PSB2201N
ZSC2200N
ZSC2201N
ZSC2202N

WIRING DIAGRAM

WARNING
POWER MUST BE DISCONNECTED
BEFORE SERVICING THIS APPLIANCE

COLOR	SYMBOL
RED	R
WHITE	W
BLACK	BK
BLUE	BL
YELLOW	Y
GREEN	GN
BROWN	BN
GRAY	GY
PINK	P

— GROUND
- - - HARNESS LEADS
— PARTS LEADS

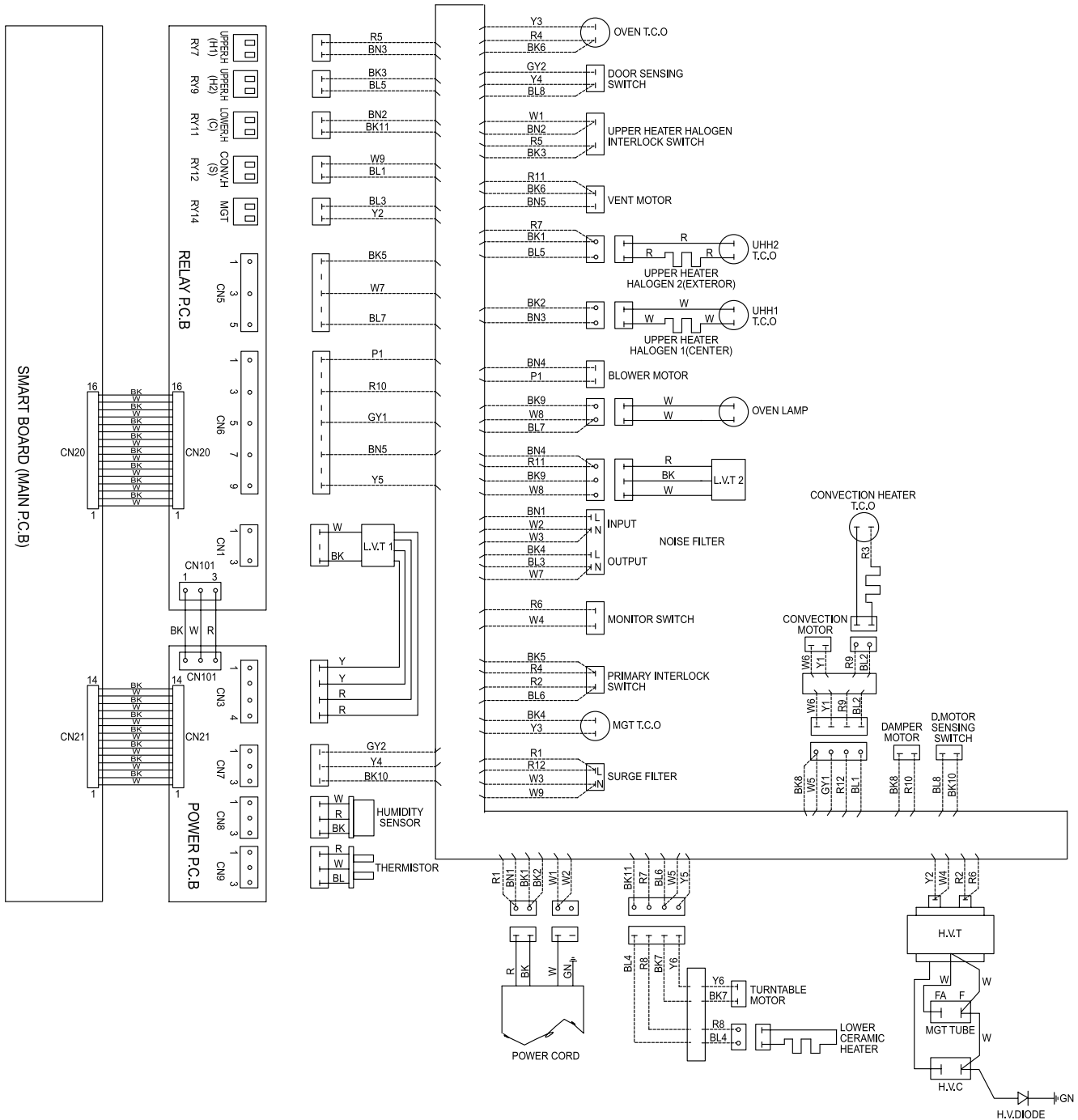

Warranty

WHAT IS COVERED

From the Date of the Original Purchase

LIMITED ONE-YEAR WARRANTY

For one year from date of original purchase, we will provide, free of charge, parts and service labor in your home to repair or replace **any part of the oven** that fails because of a manufacturing defect.

LIMITED FIVE-YEAR WARRANTY

For the second through the fifth year from the date of original purchase, we will replace the magnetron tube, if the magnetron fails due to a defect in materials or workmanship. During this additional four-year limited warranty, you will be responsible for any labor or related service costs.

.....
This warranty is extended to the original purchaser and any succeeding owner for products purchased for ordinary home use in the 48 mainland states, Hawaii, Washington, D.C. or Canada. If the product is located in an area where service by a GE Authorized Servicer is not available, you may be responsible for a trip charge or you may be required to bring the product to an Authorized GE Service location for service. In Alaska the warranty is the same except that it is LIMITED because you must pay to ship the product to the service shop or for the service technician's travel costs to your home.

All warranty service will be provided by our Factory Service Centers or by our authorized Customer Care® servicers during normal working hours.

Should your appliance need service, during warranty period or beyond, in the USA call 800.444.1845. In Canada: 800.561.3344. Please have your serial number and model number available when calling for service.

WHAT IS NOT COVERED

- Service trips to your home to teach you how to use the product.
- Improper installation, delivery or maintenance.
If you have an installation problem, contact your dealer or installer. You are responsible for providing adequate electrical, gas, exhausting and other connecting facilities as described in the Installation Instructions provided with the product.
- Replacement of house fuses or resetting of circuit breakers.
- Damage to the product due to misuse or abuse.
- Failure of the product if it is used for other than its intended purpose or used commercially.
- Damage to product caused by accident, fire, floods or acts of God.
- Incidental or consequential damage caused by possible defects with this appliance.
- Damage caused after delivery.
- Product not accessible to provide required service.

EXCLUSION OF IMPLIED WARRANTIES—Your sole and exclusive remedy is product repair as provided in this Limited Warranty. Any implied warranties, including the implied warranties of merchantability or fitness for a particular purpose, are limited to one year or the shortest period allowed by law.

Some states do not allow the exclusion or limitation of incidental or consequential damages, so the above limitation or exclusion may not apply to you. This warranty gives you specific legal rights, and you may also have other rights which vary from state to state. To know what your legal rights are in your state, consult your local or state consumer affairs office or your state's Attorney General.

Warrantor: General Electric Company, Louisville, KY 40225



GE Consumer & Industrial
Appliances
General Electric Company
Louisville, KY 40225
monogram.com